

Centrale termoregolazione

art. 3550

Manuale d'installazione

Temperature control unit

item 3550

Installation manual

bticino



I**ITALIANO****3**

GB**ENGLISH****89**

1 INTRODUZIONE	5
1.1 Avvertenze e consigli	5
1.2 Contenuto della confezione	5
2 DESCRIZIONE DELLA CENTRALE	6
2.1 Vista generale	6
2.2 Display	7
2.3 Tasti di navigazione	8
2.4 Tastiera	8
2.5 Funzioni principali	9
2.6 Modalità di funzionamento	9
2.7 Impostazioni di fabbrica	10
3 INSTALLAZIONE	11
3.1 Vista posteriore della Centrale	11
3.2 Collegamento della batteria	11
3.3 Installazione a parete con base metallica a corredo	12
3.4 Installazione in scatola Multibox	13
4 PRIMA ATTIVAZIONE	14
4.1 Scelta della lingua	14
4.2 Apprendimento delle zone	15
4.3 Personalizzazione delle zone	16
4.4 Configurazione degli attuatori delle zone	17
4.5 Configurazione delle pompe	19
4.6 Impostazione della Data e dell'Ora	21
4.7 Impostazione dell'impianto Estate/Inverno	22
5 MENÙ PRINCIPALE	23
5.1 Modalità	25
5.1.1 Settimanale	26
5.1.2 Manuale	27
5.1.3 Scenari	28
5.1.4 Festivo	29
5.1.5 Ferie	30
5.1.6 OFF	31
5.1.7 Antigelo / Protezione termica	32

INDICE

5.2 Stato zone	33
5.3 Profili attuali	34
5.4 Programmazione	35
5.4.1 Settimanale	36
5.4.2 Scenari	46
5.4.3 Festivo	52
5.5 Impostazioni	56
5.5.1 Temperature	57
5.5.2 Estate/Inverno	58
5.5.3 Data/ora	59
5.5.4 Controllo remoto	60
5.5.5 Codice utente	61
5.5.6 Contrasto	62
5.5.7 Diagnostica	63
5.6 Sensori	66
5.7 Gestione contatti	67
5.8 Chiller	68
5.9 Manutenzione	69
5.9.1 Lingua	70
5.9.2 Configura zone	71
5.9.3 Taratura sonde	81
5.9.4 Test sistema	82
5.9.5 Codice manutenzione	83
5.9.6 Reset totale	84
5.9.7 Automazioni	85

APPENDICE	86
------------------	-----------

COME RISOLVERE EVENTUALI PROBLEMI	87
--	-----------

1 INTRODUZIONE

1.1 Avvertenze e consigli

Prima di procedere con l'installazione è importante leggere attentamente il presente manuale, in quanto la garanzia decade automaticamente per negligenza, errata manovra, uso improprio, manomissione del circuito per opera di personale non autorizzato. Inoltre, decade quando il guasto è dovuto a forti sovratensioni accidentali presenti sulla rete di alimentazione. Pertanto se la Centrale, viene installata in luogo soggetto a violente scariche atmosferiche (*temporali*), devono essere installate adeguate protezioni sulla linea di alimentazione, eseguendo il collegamento di terra nel modo più rigoroso possibile e rispettando le norme CEI.

1.2 Contenuto della confezione

La confezione della Centrale contiene:

- Centrale termoregolazione art. 3550
- Base in metallo per installazione a parete
- Manuale d'installazione
- Manuale d'uso
- CD-ROM contenente software TITHERMO e manuali in formato PDF

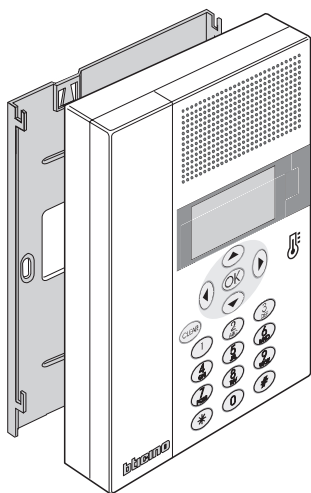

2 DESCRIZIONE DELLA CENTRALE

2.1 Vista generale

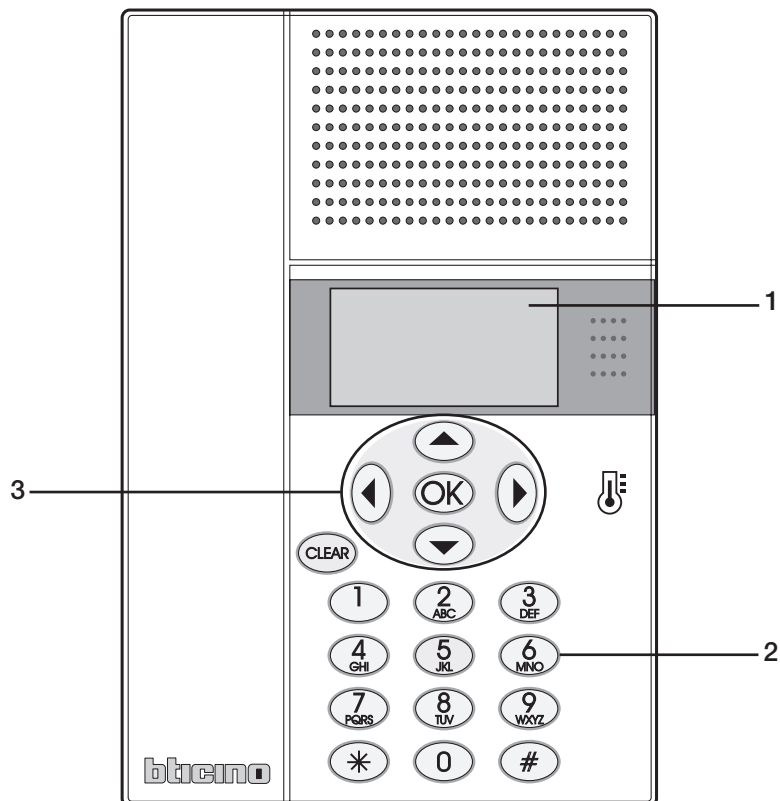

1 Display alfanumerico; visualizza i messaggi che guidano le operazioni di programmazione e gli eventi accaduti (*maggiori informazioni alla pagina successiva*).

2 Tastiera; permette l'inserimento manuale di tutte quelle operazioni di programmazione che richiedano l'utilizzo di numeri e/o simboli.

3 Tastiera di navigazione; permette la navigazione all'interno dei menù, la conferma o l'annullamento delle operazioni di programmazione.

2 DESCRIZIONE DELLA CENTRALE

2.2 Display

Pagina iniziale

In condizione di funzionamento normale il display della Centrale visualizza nella pagina iniziale le seguenti informazioni:

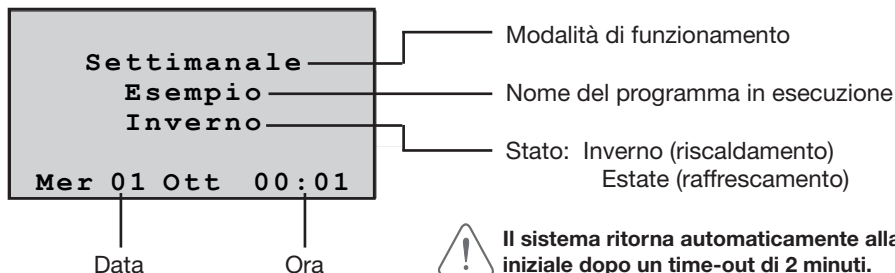

Icone

In condizione di funzionamento normale, quando per alcune zone dell'impianto viene impostata una delle seguenti modalità, il display della Centrale visualizza nella pagina iniziale le relative icone:

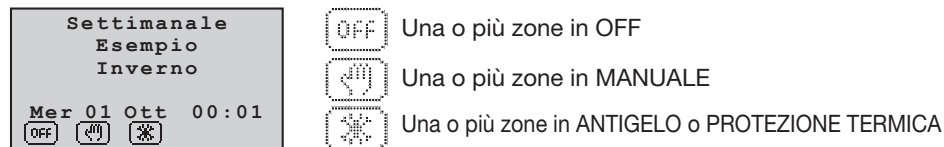

Quando una modalità è applicata a **TUTTE LE ZONE** dell'impianto sul display della centrale vengono riportate le seguenti informazioni:

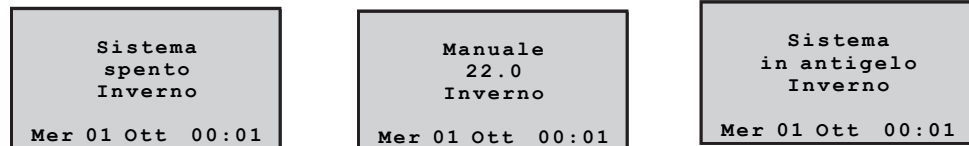

Segnalazione guasti

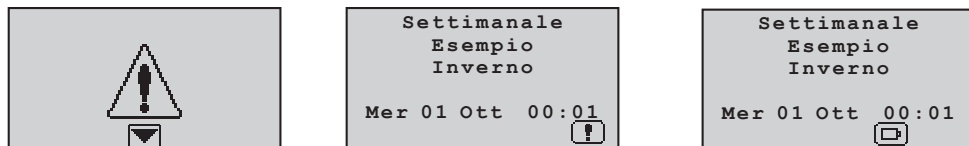

La pagina indica un'anomalia sull'impianto; premendo un tasto qualunque è possibile accedere direttamente al Menù Diagnostica.

L'icona indica un'anomalia di funzionamento in una o più zone dell'impianto.

Batteria guasta

2 DESCRIZIONE DELLA CENTRALE

2.3 Tasti di navigazione

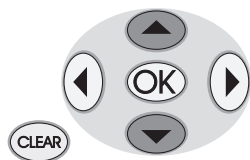

Tasti di scorrimento, permettono di scorrere l'elenco delle voci presenti nei menù.

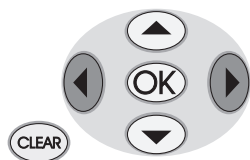

Tasti di selezione, permettono la selezione delle funzioni quando presenti all'interno dei menù.

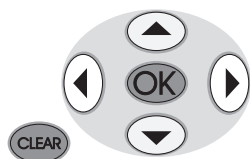
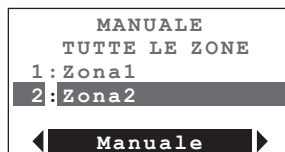

OK - Tasto di conferma della selezione visualizzata o dei dati inseriti
CLEAR - Tasto di annullamento della selezione e ritorno alla pagina precedente - tenere premuto per uscire dal menù Principale e tornare alla pagina iniziale.

2.4 Tastiera

Scrittura del testo

- ✓ Premere più volte un tasto numerico finchè non viene visualizzato il carattere desiderato; se la lettera desiderata si trova in corrispondenza dello stesso tasto di quella corrente, attendere lo spostamento del cursore
- ✓ Per inserire uno spazio premere **0**
- ✓ Per spostare il cursore usare i tasti **◀ ▶**
- ✓ Per cancellare una lettera posizionare il cursore su di essa con i tasti **◀ ▶** e premere **0**
- ✓ Per passare dal minuscolo al maiuscolo tenere premuto il tasto quando viene visualizzato il carattere desiderato, i caratteri successivi saranno in maiuscolo; per tornare al minuscolo la procedura è identica
- ✓ È possibile inserire simboli di punteggiatura premendo **1**

2 DESCRIZIONE DELLA CENTRALE

2.5 Funzioni principali

La Centrale art.3550, utilizzabile esclusivamente per la funzione termoregolazione My Home di BTicino, consente di impostare l'impianto e di modificare la modalità di funzionamento. Dotata di un software di gestione con menù guidati e visualizzati sul display, consente all'utente di scegliere la modalità di funzionamento, visualizzare le temperature delle singole zone, visualizzare e modificare i profili di temperatura giornalieri e i programmi settimanali, mentre il menù manutenzione, riservato all'installatore (protetto da codice), dà accesso alle impostazioni dell'impianto (configurazione delle zone, test del sistema, reset totale...). La Centrale può gestire impianti di riscaldamento e raffrescamento fino ad un massimo di 99 zone. È prevista la possibilità di collegare un contatto in ingresso per il controllo remoto (commutazione dalla modalità antigelo a quella automatica e viceversa) tramite attuatore telefonico.

2.6 Modalità di funzionamento

Sono selezionabili 7 differenti modalità di funzionamento:

Settimanale

Per ognuna delle due funzioni (*riscaldamento e raffrescamento*) si possono creare 3 programmi settimanali; per ognuno di essi è possibile definire dei profili di temperatura giornalieri (0h - 24h) diversi per ogni giorno della settimana e per ogni zona.

Manuale

In questa modalità è possibile impostare una temperatura fissa su tutto l'impianto o sulla singola zona senza fasce orarie; per la singola zona, quando viene disinserita la modalità manuale viene ripristinato in automatico il funzionamento sull'ultima programmazione impostata.

Scenario

In questa modalità è possibile definire degli scenari che verranno attivati dall'utente in base alle proprie esigenze; questi scenari impostano nelle varie zone una temperatura predefinita. Si possono definire fino a 16 scenari per il funzionamento *inverno* e 16 per quello *estate* e per ognuno di essi associare ad ogni zona la temperatura da regolare.

Ferie

Questa modalità consente di mantenere l'impianto in Antigelo o Protezione termica fino alla data e all'ora impostate, al termine sarà ripristinato il programma settimanale scelto.

2 DESCRIZIONE DELLA CENTRALE

Festivo

La modalità Festivo consente di selezionare un particolare profilo giornaliero per un periodo determinato. Il programma viene eseguito fino alla data e all'ora programmate, al termine della quale sarà ripristinato il programma settimanale scelto.

Antigelo / protezione termica

In questa modalità il sistema imposta su tutto l'impianto o sulla singola zona la temperatura antigelo o protezione termica in base alla funzione attuale dell'impianto (estate/inverno).

OFF

Quando si inserisce questa modalità di funzionamento la Centrale spegne tutte le zone selezionate fino a quando viene ripristinata una delle altre modalità.

2.7 Impostazioni di fabbrica

La centrale termoregolazione viene fornita con le seguenti impostazioni:

Codice utente	00000 (DISABILITATO)
Codice manutenzione	12345
Lingua	ITALIANO
Modalità	SETTIMANALE
Programma	ESEMPIO (preimpostato)
Stato	INVERNO
Temperature	Inverno: T*: 7.0°C - T1: 18.0°C - T2: 20°C - T3: 22°C Estate: Pt: 35.0°C - T1: 20.0°C - T2: 23°C - T3: 25°C
Controllo remoto	ABILITATO

3 INSTALLAZIONE

3.1 Vista posteriore della Centrale

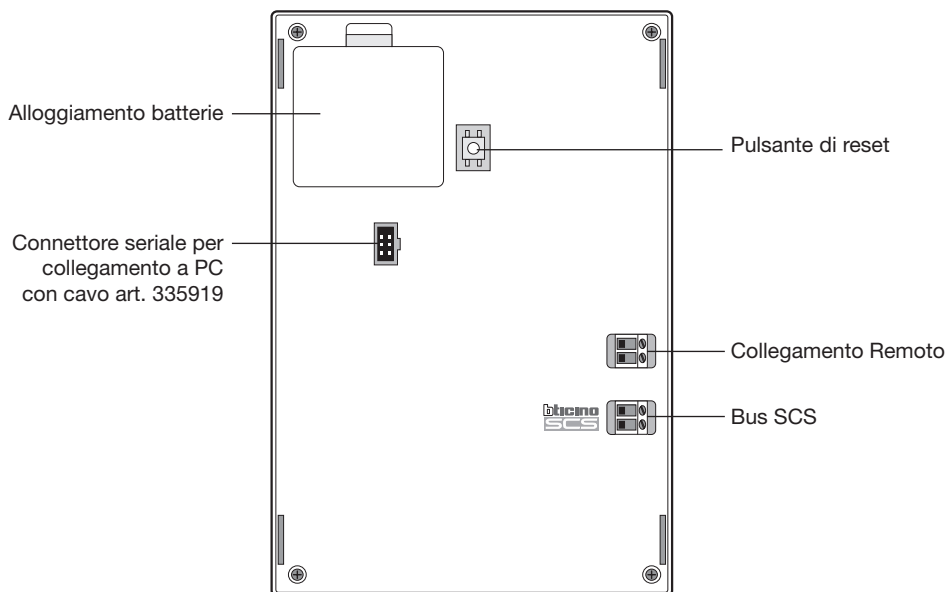

3.2 Collegamento della batteria

Collegare la batteria all'apposito connettore rispettando le polarità indicate all'interno dell'alloggiamento.

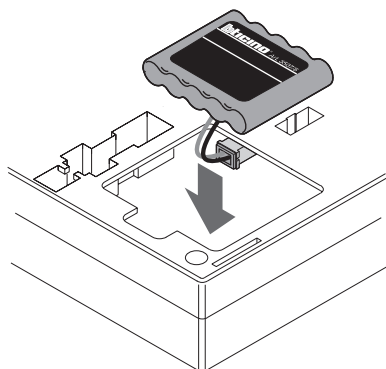
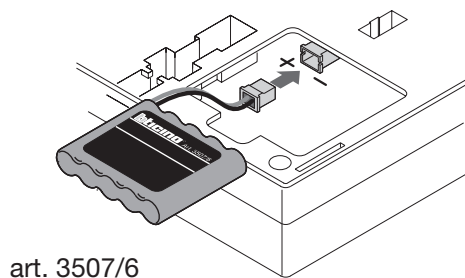

3 INSTALLAZIONE

3.3 Installazione a parete con base metallica a corredo

Fissare la base alla parete come indicato in figura:

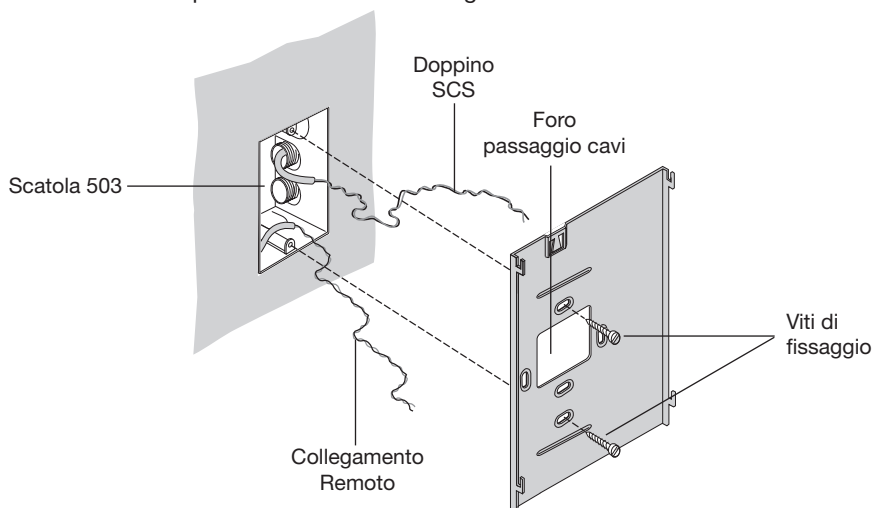

Dopo aver effettuato tutti i collegamenti fissare la Centrale alla base avendo cura di disporre i fili in modo che non vengano danneggiati.

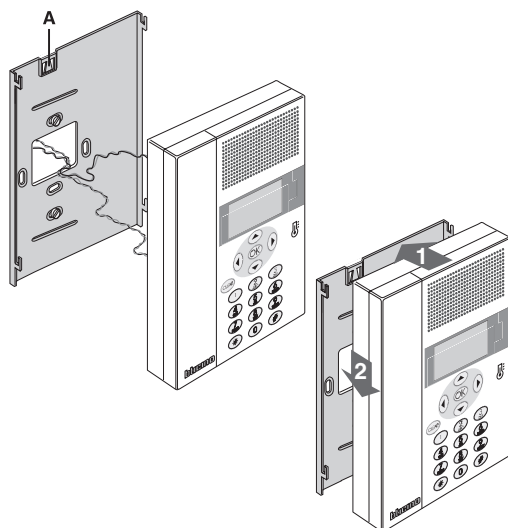

Per estrarre la centrale dalla piastra abbassare la linguetta **A** e spingere verso l'alto.

3 INSTALLAZIONE

3.4 Installazione in scatola Multibox

L'installazione in scatola Multibox va effettuata seguendo la procedura illustrata in figura.

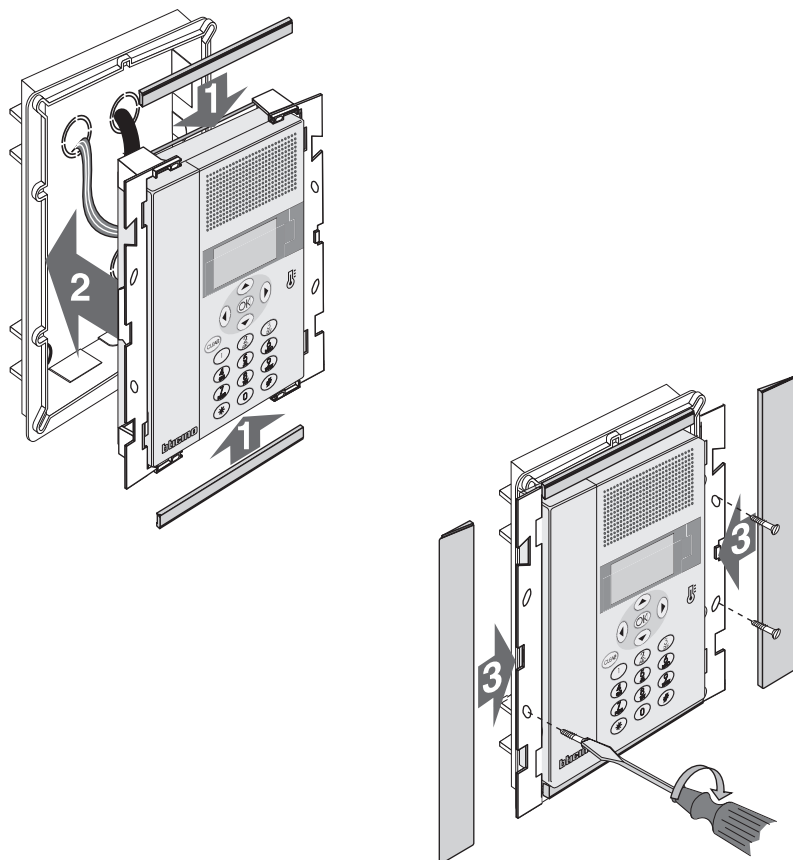

4 PRIMA ATTIVAZIONE

Quando la Centrale viene accesa per la prima volta propone il menù Manutenzione con evidenziata la funzione **Lingua**.

Per attivare la Centrale e renderla operativa:

- scegliere la lingua - **MANUTENZIONE - Lingua**
- eseguire l'apprendimento delle zone - **MANUTENZIONE - Configura zone - Apprendimento**
- personalizzare i nomi delle zone - **MANUTENZIONE - Configura zone - Rinomina**
- configurare gli attuatori delle zone - **MANUTENZIONE - Configura zone - Attuatori**
- configurare le pompe delle zone - **MANUTENZIONE - Configura zone - Pompe**
- inserire ora e data - **IMPOSTAZIONI - Data/ora**
- definire lo stato dell'impianto - **IMPOSTAZIONI - Estate / Inverno**

4.1 Scelta della lingua

Utilizzare questa funzione se la lingua preimpostata in fabbrica (Italiano) non fosse quella desiderata.

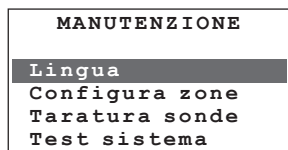

Selezionare **Lingua**



Confermare premendo **OK**

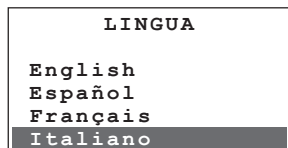

*Sul display viene evidenziata la lingua in uso
(Italiano impostazione di fabbrica)*

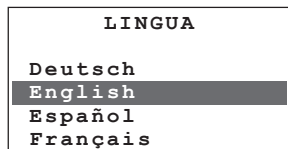

Selezionare la lingua desiderata
(es.: English)



Confermare premendo **OK**

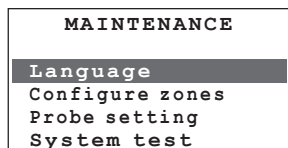

*Tutti i menù della Centrale saranno
visualizzati nella nuova lingua impostata.*

4 PRIMA ATTIVAZIONE

4.2 Apprendimento delle zone

Questa funzione consente alla Centrale di riconoscere tutte le zone dell'impianto.

MANUTENZIONE
 Lingua
Configura zone
 Taratura sonde
 Test sistema



Selezionare **Configura zone**



Confermare premendo **OK**

**Nessuna zona
 configurata**
Apprendimento

La Centrale segnala "Nessuna zona configurata", e la possibilità di eseguire l'Apprendimento



Confermare premendo **OK**

**Ricerca zona
 01**
 ●

La Centrale esegue la ricerca delle zone da 1 a 99. In funzione dell'estensione dell'impianto, questa operazione può richiedere anche alcuni minuti.

**Ricerca zona
 99**
 ●

**Acquisizione
 impianto...**



Terminata la ricerca torna al menù Configura zone

CONFIGURA ZONE
 1: **Zona 1**
 2: Zona 2
 3: Zona 3
 ◀ **Rinomina** ▶

4 PRIMA ATTIVAZIONE

4.3 Personalizzazione delle zone

Questa funzione consente di assegnare ad ogni zona un nome che meglio la identifichi.

CONFIGURA ZONE

1: Zona 1

2: Zona 2

3: Zona 3

◀ Rinomina ▶



Selezionare la zona da Rinominare (Es.: Zona 1)



Confermare premendo **OK**

CONFIGURA ZONE

1: Soggior

2: Zona 2

3: Zona 3

Memorizza



Digitare il nome della zona
(Es.: Soggiorno)



Confermare premendo **OK**

CONFIGURA ZONE

1: Soggiorno

2: Zona 2

3: Zona 3

◀ Attuatori ▶

4 PRIMA ATTIVAZIONE

4.4 Configurazione degli attuatori delle zone

Questa funzione consente di completare la configurazione delle zone, indicando:

- quali attuatori sono installati per Riscaldamento
- quali attuatori sono installati per Raffrescamento
- che tipo di carico viene gestito dalla zona



Da effettuare solo in caso di configurazione Standard

(vedere Guida My Home Termoregolazione - sezione "Configurazione sonda").

CONFIGURA ZONE

1: **Soggiorno**

2: Zona 2

3: Zona 3

◀ Attuatori ▶



Selezionare la **zona**



(Es.: Soggiorno)



Confermare premendo **OK**

Soggiorno

01: **RISCALDAM.**

02: -----

03: -----

◀ Non collegato ▶



Per ogni attuatore presente nell'elenco è possibile selezionare una delle seguenti opzioni:

◀ Non collegato ▶

Non presente sull'impianto

◀ Riscaldamento ▶

Viene utilizzato per gestire l'impianto di Riscaldamento

◀ Raffrescamento ▶

Viene utilizzato per gestire l'impianto di Raffrescamento

◀ Risc.e Raffr. ▶

Viene utilizzato per gestire sia l'impianto di Riscaldamento che l'impianto di Raffrescamento (es.: fan-coil 2 tubi)



Confermare premendo **OK**

Soggiorno

09: -----

RISC ON/OFF

RAFF APRI/CHIUDI

◀ FAN-COIL 3V ▶



Le ultime due voci del menù



consentono di selezionare il tipo di carico gestito



segue

4 PRIMA ATTIVAZIONE

4.4 Configurazione degli attuatori delle zone

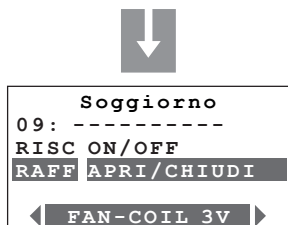

Per ogni funzionamento è possibile selezionare una delle seguenti opzioni:



Carico gestito da un solo contatto (es.: valvola termostatica)



Carico gestito da due relè interbloccati (es.: valvola motorizzata con contatto di apertura e contatto di chiusura)



Fan-coil con controllo di una valvola e selettore fino a 3 velocità



Interfaccia per FAN-COIL Climaveneta



Alla pressione del tasto CLEAR viene inviata alla zona la configurazione impostata

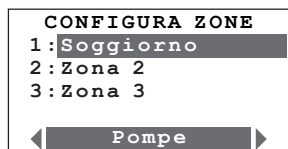
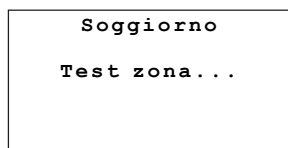

Terminata la configurazione delle zone premere 2 volte **CLEAR** per tornare al Menù Principale

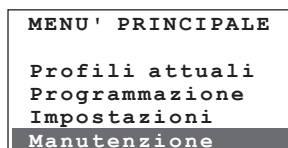

4 PRIMA ATTIVAZIONE

4.5 Configurazione delle pompe

Consente di completare la configurazione delle zone, indicando quali pompe deve controllare la zona e con quale ritardo.



Questa funzione può essere utilizzata solo se la sonda è configurata con il configuratore CEN nella sede P.

CONFIGURA ZONE

1: Soggiorno
 2: Zona 2
 3: Zona 3

◀ Pompe ▶



Selezionare **la zona**
 (Es.: Soggiorno)



Confermare premendo **OK**

Soggiorno

01: RISCALDAM.
 02: -----
 03: -----

◀ Non collegato ▶



Per ogni attuatore presente nell'elenco è possibile selezionare una delle seguenti opzioni:

◀ Non collegato ▶

Non presente sull'impianto o non gestito dalla zona selezionata

◀ Riscaldamento ▶

Viene utilizzato per gestire l'impianto di Riscaldamento

◀ Raffrescamento ▶

Viene utilizzato per gestire l'impianto di Raffrescamento

◀ Risc.e Raffr. ▶

Viene utilizzato per gestire sia l'impianto di Riscaldamento che l'impianto di Raffrescamento



Confermare premendo **OK**

Soggiorno

09: -----

RISC 1
 RAFF 0

◀ 0 ▶



Le ultime due voci del menù consentono di selezionare il ritardo di attivazione della pompa



Selezionare i minuti di ritardo



Per confermare

segue

4 PRIMA ATTIVAZIONE

4.5 Configurazione delle pompe



Soggiorno
Test zona...



CONFIGURA ZONE
1: **Soggiorno**
2: Zona 2
3: Zona 3
◀ Pompe ▶



Alla pressione del tasto CLEAR viene inviata alla zona la configurazione impostata

La centrale invia la configurazione:

Può esserci la seguente segnalazione di errore

Soggiorno
ERRORE
Verifica la
configurazione
della sonda

Verificare che la sonda sia in configurazione (P = CEN) e riprovare; se non c'è questo tipo di configurazione, la sonda non è configurabile via centrale.

4 PRIMA ATTIVAZIONE

4.6 Impostazione della Data e dell'Ora

Impostare correttamente Data/Ora è importante affinché si possano eseguire correttamente i programmi settimanali impostati.

```
MENU' PRINCIPALE
Stato zone
Profili attuali
Programmazione
Impostazioni
```



Selezionare **Impostazioni**



Confermare premendo **OK**

```
IMPOSTAZIONI
Temperature
Estate/Inverno
Data/ora
Controllo remoto
```



Selezionare **Data/ora**



Confermare premendo **OK**

```
CAMBIO ORA/DATA
Ora: 06:27
Data: 01/10/03
Mer 01 Ott 06:29
```

① ② ③

④ ⑤ ⑥

⑦ ⑧ ⑨

* 0 #

Digitare Ora e Data correnti



```
CAMBIO ORA/DATA
Ora: 11:30
Data: 05/11/03
Mer 01 Ott 06:29
```



I tasti spostano di una cifra la selezione



I tasti cambiano riga Ora/Data e viceversa



Confermare premendo **OK**

```
IMPOSTAZIONI
Temperature
Estate/Inverno
Data/ora
Controllo remoto
```

4 PRIMA ATTIVAZIONE

4.7 Impostazione dell'impianto Estate/Inverno

Consente di impostare il modo di funzionamento dell'impianto Raffrescamento o Riscaldamento.



Prima di effettuare la commutazione, eseguire sull'impianto idraulico tutte le operazioni necessarie per il corretto funzionamento.

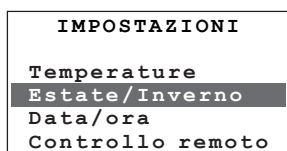

Selezionare **Estate / Inverno**



Confermare premendo **OK**



*sul display viene fornita l'indicazione dello stato attuale: **Inverno***



Confermare premendo **OK**



*un **BIP** segnala l'avvenuta modifica*

*sul display viene fornita l'indicazione della nuova impostazione: **Estate***



Dopo la commutazione l'impianto si imposta in modalità Antigelo/Protezione Termica.

5 MENÙ PRINCIPALE

Accesso al Menù Principale

Dopo aver effettuato le operazioni descritte nel capitolo “Prima attivazione”, è possibile accedere ai menù di programmazione per effettuare un’ampia serie di personalizzazioni che consentono di sfruttare a pieno le caratteristiche della Centrale termoregolazione e soddisfare le esigenze dell’utente.

Sono previsti due livelli di programmazione:

- **livello 1** (utente), consente l'accesso a tutti i menù **tranne** quello di **Manutenzione**, nel quale sono previste funzioni riservate all'installatore o ad un utente esperto. L'accesso al livello utente può essere protetto dal **Codice utente** (di base disabilitato).

- **livello 2** (installatore) consente l'accesso a tutti i menù. L'accesso al livello installatore richiede il **Codice manutenzione** (di base 12345).



Nel caso in cui i codici di accesso vengano modificati, si consiglia di riportarli nelle caselle sottostanti.

Codice utente
00000

NUOVO CODICE UTENTE

Codice manutenzione
12345

NUOVO CODICE MANUTENZIONE

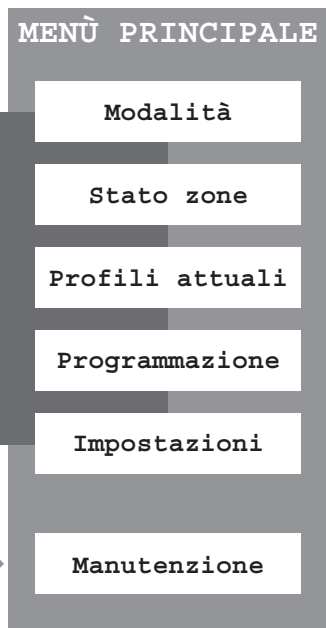

Per uscire dal Menù Principale attendere 2 minuti senza premere alcun tasto oppure premere il tasto CLEAR

5 MENÙ PRINCIPALE

Albero del Menù Principale

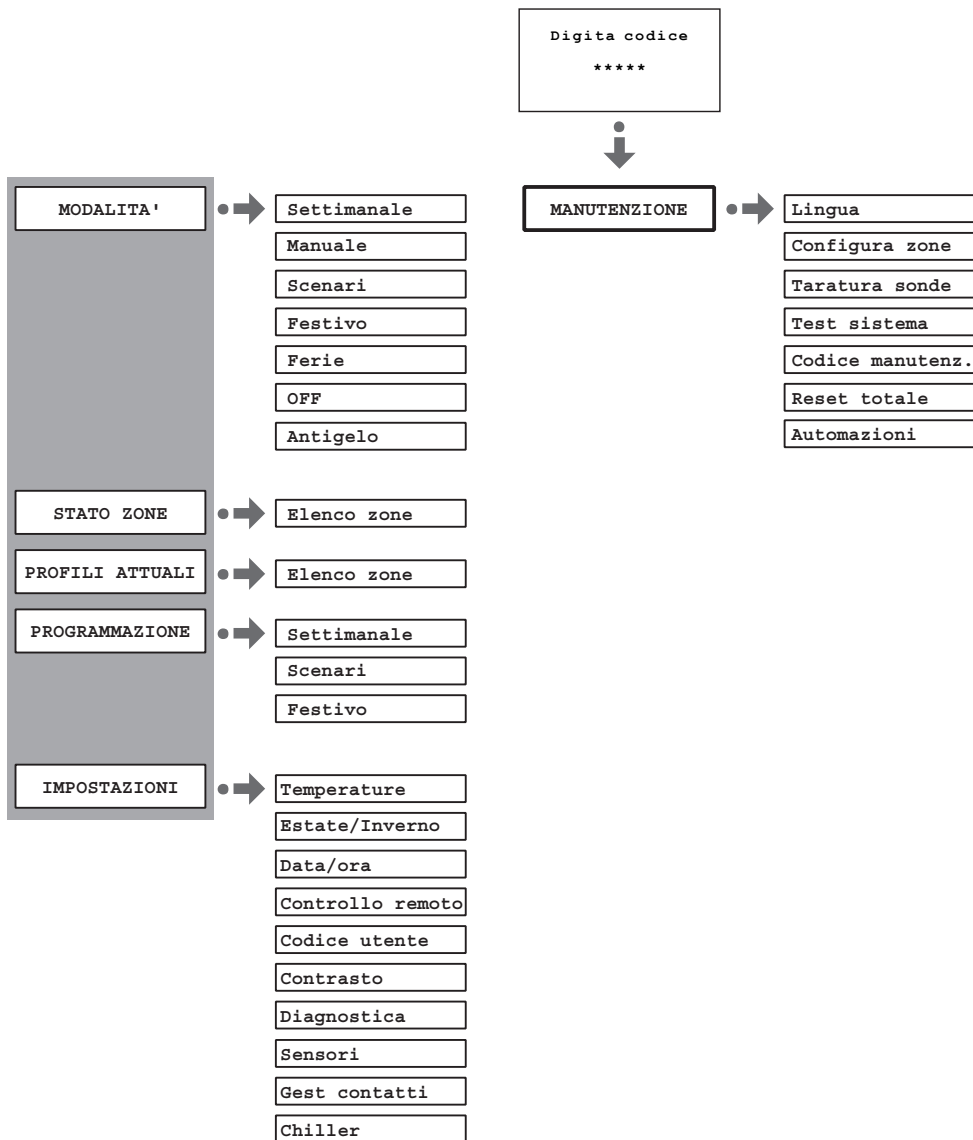

Per uscire dal Menù Principale attendere 2 minuti senza premere alcun tasto oppure premere il tasto 

5 MENÙ PRINCIPALE



5.1 Modalità

Questo menù consente di selezionare la modalità di funzionamento in ogni zona dell'impianto; le modalità attive sono contrassegnate dal numero identificativo evidenziato.

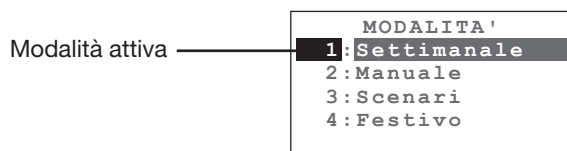

Per accedere al menù MODALITÀ:

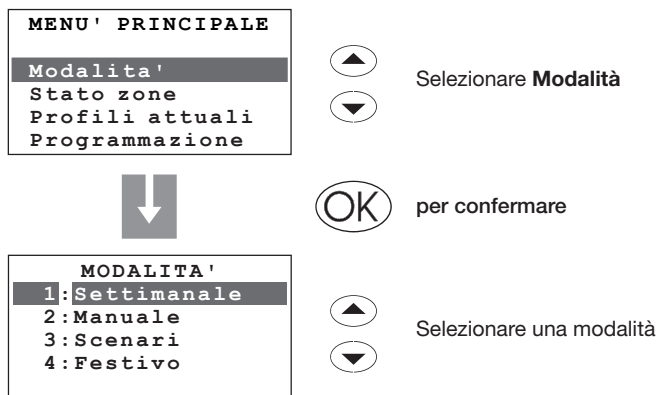

Modalità di funzionamento presenti:

- 1 : Settimanale** - 3 programmi Inverno, 3 programmi Estate
- 2 : Manuale** - temperatura fissa su tutto l'impianto o sulla singola zona
- 3 : Scenari** - 16 scenari Inverno e 16 scenari Estate
- 4 : Festivo** - programma "giorno festivo" per ogni zona
- 5 : Ferie** - impianto in antigelo o protezione termica fino alla data e all'ora impostate
- 6 : OFF** - una o più zone in OFF
- 7 : Antigelo** - una o più zone in Antigelo o Protezione termica

5 MENÙ PRINCIPALE



5.1.1 Settimanale

Consente di impostare un programma settimanale a scelta fra quelli programmati

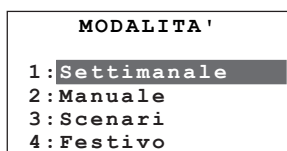

Selezionare **Settimanale**



per confermare

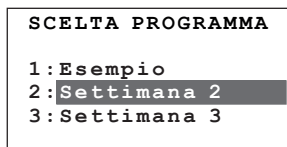

Selezionare il programma settimanale
(es.: Settimana 2)



per confermare

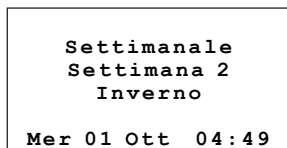

viene visualizzata la pagina iniziale con l'indicazione del programma impostato

5 MENÙ PRINCIPALE



5.1.2 Manuale

Consente di impostare una temperatura fissa su tutto l'impianto o sulla singola zona

MODALITA'

1: Settimanale
 2: **Manuale**
 3: Scenari
 4: Festivo



Selezionare **Manuale**



per confermare

MANUALE
TUTTE LE ZONE

1: Zona 1
 2: **Zona 2**

Manuale



Selezionare **TUTTE LE ZONE** o la Zona desiderata (es.: Zona 2)



per confermare

MANUALE
 Zona 2

Temperatura **18.0**



Digitare la temperatura desiderata servendosi dei tasti numerici o incrementare di $\pm 0.5^\circ\text{C}$ la temperatura visualizzata tramite i tasti



per confermare

MANUALE
TUTTE LE ZONE

1: Zona 1
 2: **Zona 2**

Manuale

Per riportare una zona impostata in modalità Manuale (numero evidenziato) alla modalità di funzionamento normale (modalità generale del sistema) selezionare tramite i tasti



Premere **OK** per confermare



per tornare alla pagina precedente, tenere premuto per tornare alla pagina iniziale

Settimanale
 Esempio
 Inverno

Mer 01 Ott 04:49



Manuale
 18.0
 Inverno

Mer 01 Ott 04:49

in funzione della scelta effettuata viene visualizzata la pagina iniziale

ALCUNE ZONE

TUTTE LE ZONE

5 MENÙ PRINCIPALE



5.1.3 Scenari

Consente di attivare uno scenario precedentemente programmato.

MODALITA'

1: **Settimanale**
 2: **Manuale**
 3: **Scenari**
 4: **Festivo**



Selezionare **Scenari**



per confermare

SCELTA SCENARIO

1: **Scenario 1**
 2: **Scenario 2**
 3: **Scenario 3**
 4: **Scenario 4**



Selezionare lo Scenario desiderato
(es.: Scenario 2)



per confermare

Scenario
 Scenario 2
 Inverno

Mer 01 Ott 04:49

viene visualizzata la pagina iniziale con l'indicazione dello scenario impostato

5 MENÙ PRINCIPALE



5.1.4 Festivo

La modalità Festivo consente di selezionare un particolare profilo giornaliero per un periodo determinato. Il programma viene eseguito fino alla data e all'ora programmata, al termine della quale sarà ripristinato il programma settimanale scelto.

MODALITA'

1: Settimanale
 2: Manuale
 3: Scenari
 4: Festivo



Selezionare **Festivo**



per confermare

FESTIVO

fino alle 00:00
 del 24/12/04

Conferma

① ② ③

④ ⑤ ⑥

Digitare ora e data

⑦ ⑧ ⑨

utilizzando i tasti numerici

* 0 #



per confermare

FINE FESTIVO

1: Esempio
 2: Settimana 2
 3: Settimana 3



Selezionare il programma settimanale da ripristinare al termine del giorno Festivo



(es.: Settimana 2)



per confermare

Festivo

fino alle 12:30
 del 27/12/04
 Inverno
 Gio 23 Dic 09:45

viene visualizzata la pagina iniziale con l'indicazione del programma impostato

5 MENÙ PRINCIPALE



5.1.5 Ferie

Questa modalità consente di mantenere l'impianto in Antigelo o Protezione termica fino alla data e all'ora impostate, al termine sarà ripristinato il programma settimanale scelto.

- antigelo 7°C (per il funzionamento riscaldamento)
- protezione termica 35°C (per il funzionamento condizionamento)

MODALITA'

2: Manuale
 3: Scenari
 4: Festivo
 5: Ferie



Selezionare **Ferie**



per confermare

FERIE

fino alle 00:00
 del 24/12/04

Conferma

- ① ② ③
- ④ ⑤ ⑥
- ⑦ ⑧ ⑨
- * 0 #

Digitare ora e data utilizzando i tasti numerici



per confermare

FINE FERIE

1: Esempio
 2: Settimana 2
 3: Settimana 3



Selezionare il programma settimanale da ripristinare al termine del programma Ferie (es.: Settimana 2)



Ferie

fino alle 08:30
 del 07/01/05

Inverno
 Gio 23 Dic 08:30

viene visualizzata la pagina iniziale con l'indicazione del programma impostato

5 MENÙ PRINCIPALE



5.1.6 OFF

Consente di mettere in stato di OFF tutte o alcune zone dell'impianto, fino a quando non viene ripristinata una delle altre modalità.

MODALITA'

3: Scenari
 4: Festivo
 5: Ferie
 6: **OFF**



Selezionare **OFF**



per confermare

OFF

TUTTE LE ZONE

1: Zona 1
 2: **Zona 2**

OFF



Selezionare **TUTTE LE ZONE** o la Zona desiderata (es.: Zona 2)



per confermare

MANUALE

TUTTE LE ZONE

1: Zona 1
 2: **Zona 2**

Automatico

Per riportare una zona impostata in modalità OFF (numero evidenziato) alla modalità di funzionamento normale (modalità generale del sistema), premere **OK**



per tornare alla pagina precedente, tenere premuto per tornare alla pagina iniziale

Settimanale

Esempio
 Inverno

Mer 01 Ott 00:01

OFF

viene visualizzata la pagina iniziale, la presenza dell'icona indica che la modalità è attiva solo in alcune Zone



Sistema spento

Inverno

Mer 01 Ott 00:01

se la modalità è attiva su TUTTE LE ZONE la pagina iniziale visualizza "Sistema spento"

5 MENÙ PRINCIPALE



5.1.7 Antigelo / Protezione termica

Consente di impostare in alcune zone o in tutto l'impianto la temperatura di antigelo o protezione termica in funzione del tipo di funzionamento attivo.

MODALITA'

4: Festivo
 5: Ferie
 6: OFF
 7: Antigelo



Selezionare **Antigelo / Prot. termica**



per confermare

ANTIGELO
TUTTE LE ZONE

1: Zona 1
 2: Zona 2

Antigelo



Selezionare **TUTTE LE ZONE** o la Zona desiderata (es.: Zona1)



per confermare

ANTIGELO
TUTTE LE ZONE

1: Zona 1
 2: Zona 2

Automatico

Per riportare una zona impostata in modalità Antigelo (numero evidenziato) alla modalità di funzionamento normale (modalità generale del sistema), premere **OK**



per tornare alla pagina precedente, tenere premuto per tornare alla pagina iniziale

Settimanale
Esempio
Inverno

Mer 01 Ott 00:01

viene visualizzata la pagina iniziale, la presenza dell'icona indica che la modalità è attiva solo in alcune Zone



Sistema
in antigelo
Inverno

Mer 01 Ott 00:01

se la modalità è attiva su TUTTE LE ZONE la pagina iniziale visualizza "Sistema in antigelo"

5 MENÙ PRINCIPALE

Modalità

Stato zone

Profili attuali

Programmazione

Impostazioni

Manutenzione

5.2 Stato zone

Consente di conoscere per ogni zona la temperatura misurata, la temperatura impostata e lo stato dell'impianto.

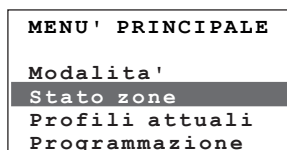

Selezionare **Stato zone**



per confermare

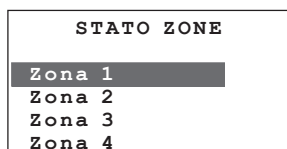

Selezionare la Zona desiderata
(es.: Zona 1)



per confermare

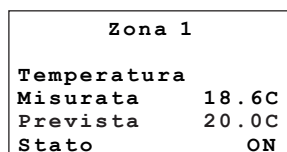
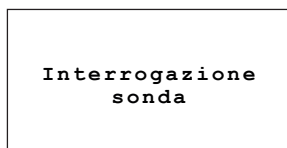

Sul display vengono visualizzate le seguenti informazioni:

- temperatura misurata nella zona
- temperatura impostata nella zona
- stato dell'impianto nella zona:

ON = impianto acceso

OFF = impianto spento

In caso di impianto con FAN-COIL è riportata anche la velocità della ventola.



utilizzare i tasti per selezionare
le altre zone (es.: Zona 2)

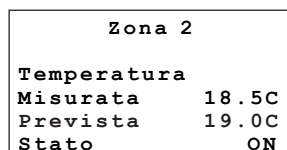

Premere **CLEAR** per 2 secondi per tornare alla pagina iniziale

5 MENÙ PRINCIPALE



5.3 Profili attuali

Consente per ogni zona, di verificare la modalità di funzionamento ed il profilo impostato.

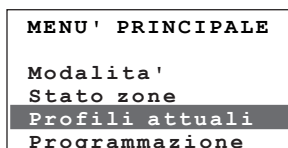

Selezionare **Profili attuali**



per confermare

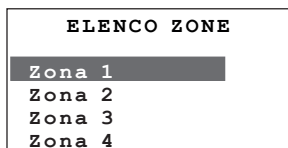

Selezionare la Zona desiderata
(es.: Zona 1)



per confermare

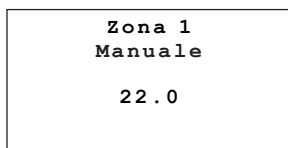

utilizzare i tasti per selezionare
le altre zone (es.: Zona 2)

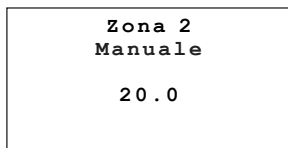

Se la zona selezionata è in modalità Settimanale, viene visualizzata la schermata del profilo termico impostato

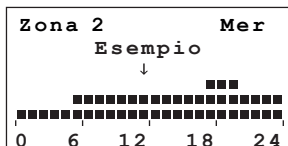

Premere **CLEAR** per 2 secondi per tornare alla pagina iniziale

5 MENÙ PRINCIPALE



5.4 Programmazione

Questo menù consente la programmazione dei profili per le modalità di funzionamento dell'impianto.

Per accedere al menù PROGRAMMAZIONE:



Programmazioni presenti:

Settimanale - 3 programmi Inverno, 3 programmi Estate

Scenari - 16 scenari Inverno e 16 scenari Estate

Festivo - programma "giorno festivo" per ogni zona

5 MENÙ PRINCIPALE



5.4.1 Settimanale

Consente di creare fino a 3 programmi settimanali per ognuno dei modi di funzionamento dell'impianto (riscaldamento e raffrescamento). Per ogni programma si possono definire dei profili di temperatura giornalieri (0h-24h) diversi per ogni giorno e per ogni zona.

PROGRAMMAZIONE

Settimanale
Scenari
Festivo



Selezionare **Settimanale**



per confermare

SCELTA PROGRAMMA

Esempio
Settimana 2
Settimana 3

Rinomina

Per il programma selezionato sono disponibili le seguenti funzioni:



Consente di rinominare il programma settimanale



Consente di modificare il programma settimanale



Consente di copiare un programma settimanale



Consente di visualizzare i profili giornalieri associati ad ogni zona



Consente di eliminare un programma settimanale

Selezionare la funzione desiderata tramite i tasti

Nota: il programma "Esempio" è preimpostato ma modificabile

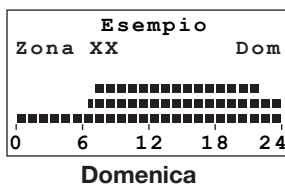
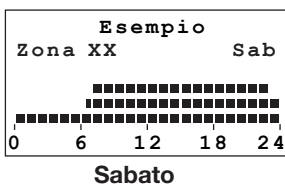
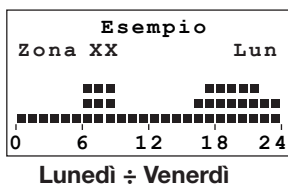

5 MENÙ PRINCIPALE



5.4.1.1 Rinomina

Questa funzione consente di rinominare il programma settimanale selezionato (max 13 caratteri).

SCELTA PROGRAMMA
 Esempio
 Settimana 2
 Settimana 3
 Rinomina



Selezionare il programma da rinominare
 (Es.: Settimana 2)



per confermare

SCELTA PROGRAMMA
 Esempio
 Sett.invern
 Settimana 3
 Memorizza

- ① ② ③
- ④ ⑤ ⑥
- ⑦ ⑧ ⑨
- * 0 #

Digitare il nome da assegnare al programma
 (Es.: Sett. inverno)



per confermare

SCELTA PROGRAMMA
 Esempio
 Sett.inverno
 Settimana 3
 Modifica

CLEAR per tornare alla pagina precedente,
 tenere premuto per tornare alla pagina iniziale

5 MENÙ PRINCIPALE



5.4.1.2 Modifica

Questa funzione consente di modificare il programma settimanale selezionato, associando un profilo giornaliero ad ogni zona.

SCELTA PROGRAMMA
 Esempio
 Settimana 2
 Settimana 3
 Modifica

▲ Selezionare il programma da modificare (Es.: Esempio)
 ▼



OK per confermare

SCELTA GIORNO
 Venerdì '
 Sabato
 Domenica
 Modifica

▲ Selezionare il giorno della settimana (Es.: Domenica)
 ▼

Per il giorno selezionato è disponibile anche la funzione:

Copia da (giorno)



OK per confermare

SCELTA ZONA
 Zona 1
 Zona 2
 Modifica

▲ Selezionare la zona (Es.: Zona 1)
 ▼

Per la zona selezionata sono disponibili anche le funzioni:

Copia da (zona) Visualizza



OK per confermare

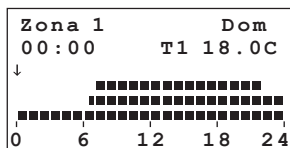

È ora possibile modificare il profilo visualizzato usando i tasti di navigazione ◀ ▶ e ▲ ▼

Per maggiori dettagli vedere l'esempio nella pagina seguente

5 MENÙ PRINCIPALE

Modalità

Stato zone

Profili attuali

Programmazione

Impostazioni

Manutenzione

Modifica di un profilo giornaliero

Sul display sono visualizzate le seguenti informazioni:

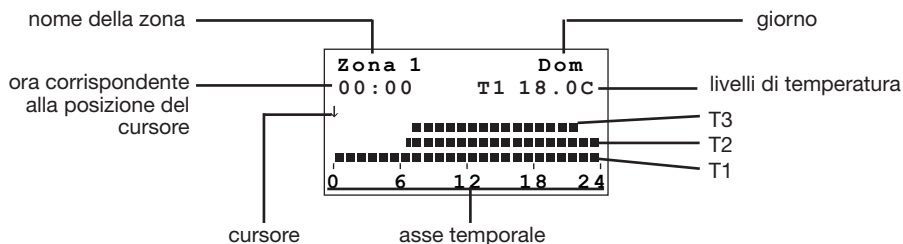

Sono presenti due modalità di lavoro:

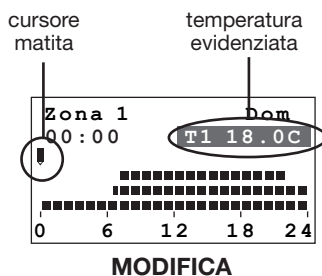
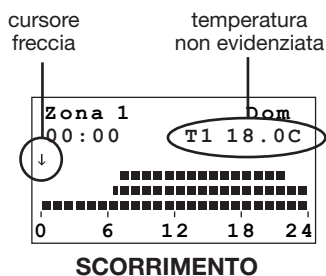

Come usare i tasti di navigazione:



- spostano il cursore lungo l'asse temporale



- passano dalla modalità SCORRIMENTO a MODIFICA
- nella modalità MODIFICA scorrono i tre livelli di temperatura



OK - passa dalla modalità MODIFICA a SCORRIMENTO
- in modalità SCORRIMENTO conferma uscendo da **Modifica**

CLEAR - torna alla pagina precedente senza memorizzare

5 MENÙ PRINCIPALE



Esempio:

scrittura del seguente profilo di temperatura giornaliero (Lunedì):

- dalle ore 00:00 alle ore 06:00 - 18°C (T1)
- dalle ore 06:00 alle ore 09:00 - 22°C (T3)
- dalle ore 09:00 alle ore 16:30 - 20°C (T2)
- dalle ore 16:30 alle ore 22:00 - 22°C (T3)
- dalle ore 22:00 alle ore 24:00 - 20°C (T2)

Livelli di temperatura impostati

T1= 18°C - T2= 20°C - T3= 22°C

Procedura:

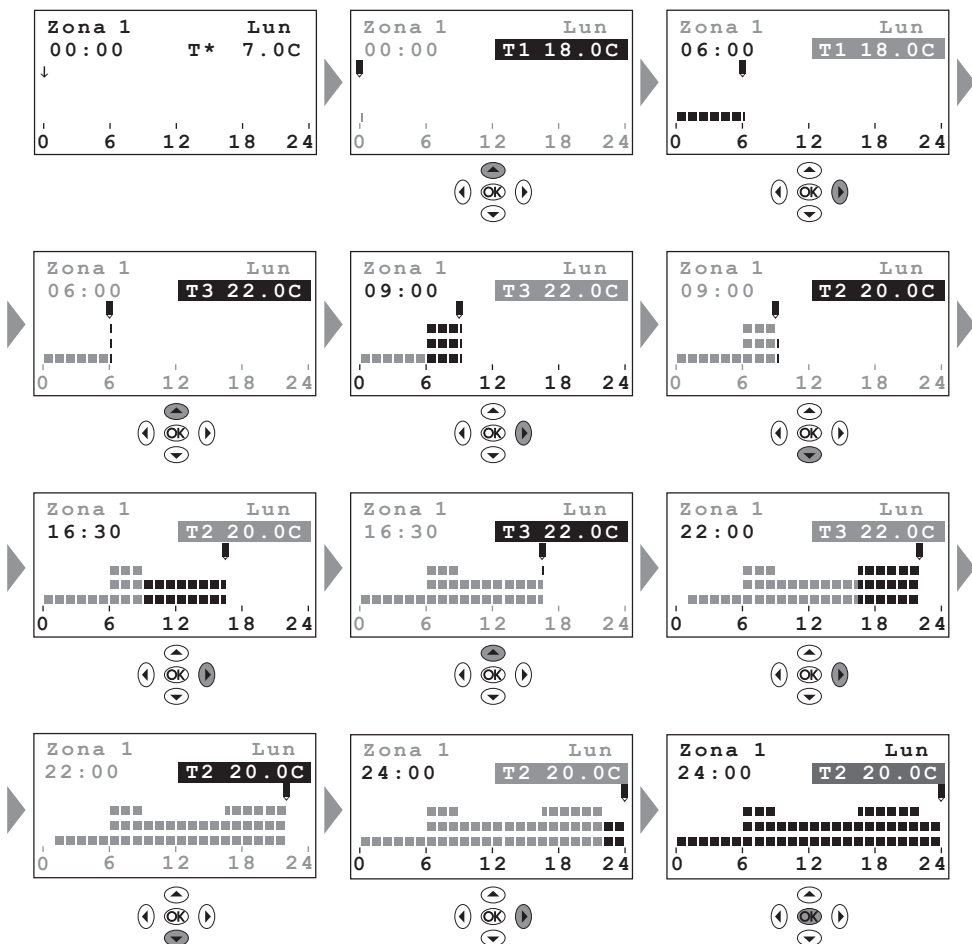

5 MENÙ PRINCIPALE

Modalità

Stato zone

Profili attuali

Programmazione

Impostazioni

Manutenzione

Copia da (giorno)

Selezionando la funzione “Copia da” è possibile copiare un profilo giornaliero.

SCELTA GIORNO

Lunedì ' **Martedì ' Mercoledì '**

◀ Modifica ▶



Selezionare **Copia da**



SCELTA GIORNO

Lunedì ' **Martedì ' Mercoledì '**

◀ Copia da ▶



Selezionare il giorno da modificare
(Es.: Martedì)



per confermare

COPIA DA

Lunedì ' Martedì ' Mercoledì ' Giovedì



Selezionare il giorno da copiare
(Es.: Lunedì)



per confermare

Esempio

Copia in corso
da: Lunedì '
a: Martedì '



SCELTA GIORNO

Lunedì ' Martedì ' Mercoledì '

◀ Copia da ▶

5 MENÙ PRINCIPALE



Copia da (zona)

Selezionando la funzione “Copia da” è possibile copiare il profilo giornaliero di una zona.

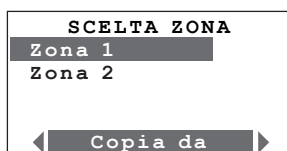

Selezionare la zona nel quale copiare



per confermare

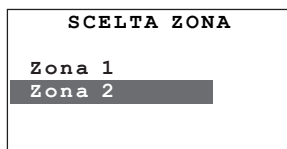

Selezionare la zona da copiare



per confermare

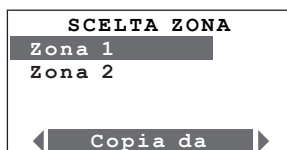

5 MENÙ PRINCIPALE

Modalità

Stato zone

Profili attuali

Programmazione

Impostazioni

Manutenzione

5.4.1.3 Copia da (programma settimanale)

Questa funzione consente di copiare un programma settimanale

SCELTA PROGRAMMA
 Esempio
 Settimana 2
 Settimana 3
 ◀ Copia da ▶



Selezionare il programma nel quale copiare



per confermare

COPIA DA
 Esempio
 Settimana 2
 Settimana 3
 ◀ Copia da ▶



Selezionare il programma da copiare



per confermare

Copia in corso
 da: Esempio
 a: Settimana 2



SCELTA PROGRAMMA
 Esempio
 Settimana 2
 Settimana 3
 ◀ Copia da ▶

CLEAR per tornare alla pagina precedente;
 tenere premuto per tornare alla pagina iniziale

5 MENÙ PRINCIPALE



5.4.1.4 Visualizza

Questa funzione consente di visualizzare i profili giornalieri associati ad ogni zona.

SCELTA PROGRAMMA
Esempio
 Settimana 2
 Settimana 3
 ◀ Visualizza ▶



Selezionare il programma settimanale
 (Es.: Esempio)



per confermare

Esempio
Domenica
 Lunedì '
 Martedì '
 Mercoledì '



Selezionare il giorno della settimana
 (Es.: Domenica)



per confermare

Domenica
Zona 1
 Zona 2



Selezionare la zona
 (Es.: Zona 1)



per confermare



CLEAR per tornare alla pagina precedente;
 tenere premuto per tornare alla pagina iniziale

5 MENÙ PRINCIPALE



5.4.1.5 Elimina

Questa funzione consente di eliminare un programma settimanale ripristinando il nome di default, i profili di tutte le zone e mettendo il programma in antigelo o protezione termica.

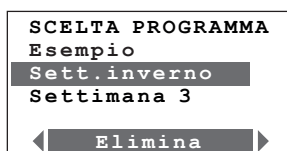

Selezionare il programma da eliminare (Es.: Sett. Inverno)



per confermare

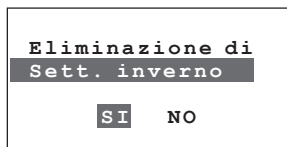

Selezionare **SI**



per confermare

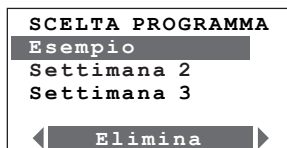

CLEAR per tornare alla pagina precedente;
tenere premuto per tornare alla pagina iniziale

5 MENÙ PRINCIPALE



5.4.2 Scenari

Consente di creare 16 scenari per il funzionamento Inverno e 16 per il funzionamento Estate e per ognuno di essi impostare nelle varie zone temperature differenti.

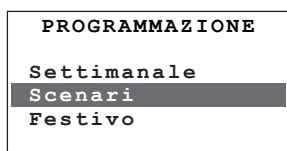

Selezionare **Scenari**



per confermare

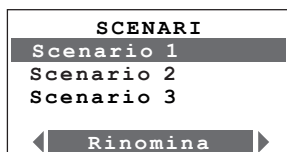

Per lo scenario selezionato sono disponibili le seguenti funzioni:



Consente di rinominare gli scenari

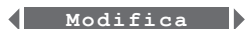

Consente di modificare gli scenari



Consente di copiare gli scenari



Consente di visualizzare il livello di temperatura impostato

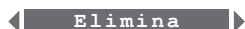

Consente di eliminare uno scenario

Selezionare la funzione desiderata tramite i tasti  

5 MENÙ PRINCIPALE



5.4.2.1 Rinomina

Questa funzione consente di rinominare lo scenario selezionato (max 13 caratteri).

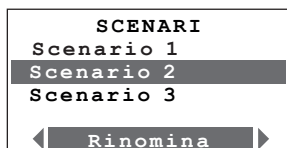

Selezionare lo scenario da rinominare
(Es.: Scenario 2)



per confermare

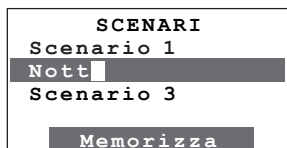

Digitare il nome da assegnare allo scenario
(Es.: Notte)



per confermare

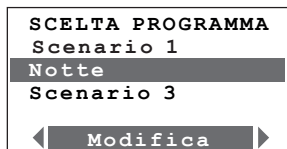

CLEAR per tornare alla pagina precedente;
tenere premuto per tornare alla pagina iniziale

5 MENÙ PRINCIPALE



5.4.2.2 Modifica

Questa funzione consente di modificare lo scenario selezionato associando ad ogni zona un livello di temperatura.

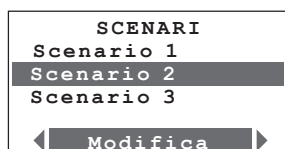

Selezionare lo scenario da modificare
(Es.: Scenario 2)



per confermare

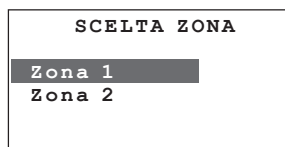

Selezionare la zona
(Es.: Zona 1)



per confermare

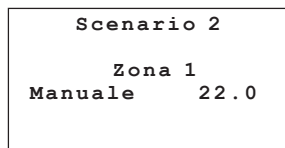

Impostare la temperatura servendosi dei tasti numerici o dei tasti ▲ ▼ (incremento di $\pm 0.5^{\circ}\text{C}$)



per confermare

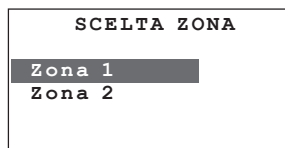

CLEAR per tornare alla pagina precedente;
tenere premuto per tornare alla pagina iniziale

5 MENÙ PRINCIPALE

Modalità

Stato zone

Profili attuali

Programmazione

Impostazioni

Manutenzione

5.4.2.3 Copia da

Questa funzione consente di copiare uno scenario (livello di temperatura impostato per ogni singola zona).

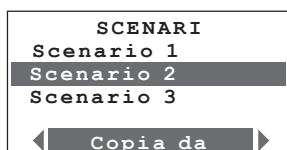

Selezionare lo scenario in cui copiare
(Es.: Scenario 2)



per confermare

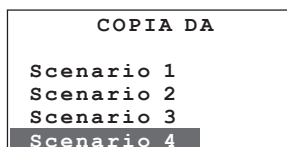

Selezionare lo scenario da copiare
(Es.: Scenario 4)



per confermare

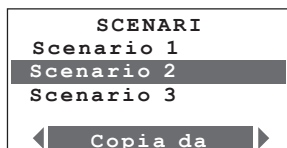

CLEAR per tornare alla pagina precedente;
tenere premuto per tornare alla pagina iniziale

5 MENÙ PRINCIPALE



5.4.2.4 Visualizza

Consente di visualizzare il livello di temperatura impostato per ogni zona.

SCENARI

Scenario 1

Scenario 2

Scenario 3

◀ Visualizza ▶



Selezionare lo scenario da visualizzare
(Es.: Scenario 2)



per confermare

Scenario 2

Zona 1

Zona 2



Selezionare la zona
(Es.: Zona 1)



per confermare

Scenario 2

Zona 1

Manuale 22.0

CLEAR per tornare alla pagina precedente;
tenere premuto per tornare alla pagina iniziale

5 MENÙ PRINCIPALE

Modalità

Stato zone

Profili attuali

Programmazione

Impostazioni

Manutenzione

5.4.2.5 Elimina

Consente di eliminare lo scenario selezionato e di ripristinare il nome e le temperature di default (20°C per l'inverno, 23°C per l'estate).

SCENARI

Scenario 1

Notte

Scenario 3

◀ Elimina ▶



Selezionare lo scenario da eliminare
(Es.: Notte)



per confermare

Eliminazione di

Notte

SI NO



Selezionare **SI**



per confermare

SCENARI

Scenario 1

Scenario 2

Scenario 3

◀ Elimina ▶

CLEAR per tornare alla pagina precedente;
tenere premuto per tornare alla pagina iniziale

5 MENÙ PRINCIPALE



5.4.3 Festivo

Consente di programmare per ogni zona un profilo giornaliero (di base è associato ad ogni zona il profilo della domenica del programma Esempio).

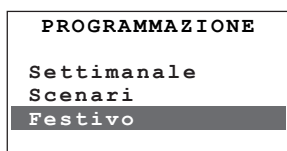

Selezionare **Festivo**



per confermare

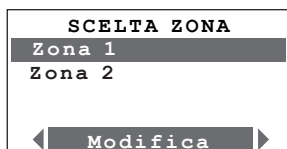

*Per la zona selezionata
sono disponibili le seguenti funzioni:*

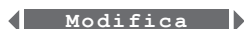

Consente di modificare il profilo giornaliero delle singole zone

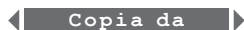

Consente di copiare il profilo da un'altra zona

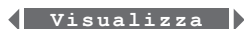

Consente di visualizzare il profilo giornaliero associato alla zona

Selezionare la funzione desiderata tramite i tasti ◀ ▶

5 MENÙ PRINCIPALE



5.4.3.1 Modifica

Consente di modificare il profilo giornaliero associato ad una zona.

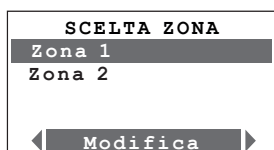

Selezionare la zona da modificare (Es.: Zona 1)



per confermare

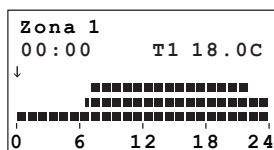

Modificare il profilo giornaliero

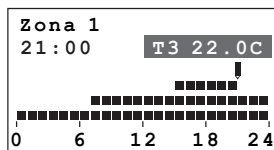

per confermare

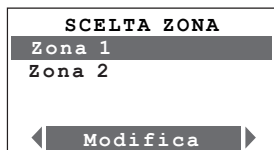

CLEAR per tornare alla pagina precedente;
tenere premuto per tornare alla pagina iniziale

5 MENÙ PRINCIPALE



5.4.3.2 Copia da

Consente di copiare il profilo giornaliero da una zona già programmata.

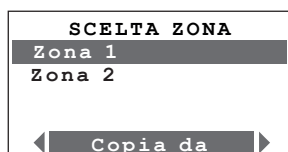

Selezionare la zona in cui copiare (Es.: Zona 1)



per confermare

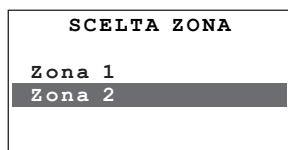

Selezionare la zona da copiare (Es.: Zona 2)



per confermare

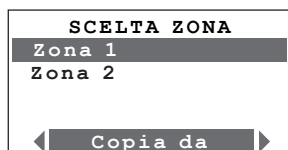

CLEAR per tornare alla pagina precedente;
tenere premuto per tornare alla pagina iniziale

5 MENÙ PRINCIPALE

Modalità

Stato zone

Profili attuali

Programmazione

Impostazioni

Manutenzione

5.4.3.3 Visualizza

Consente di visualizzare il profilo giornaliero associato ad ogni zona.

SCELTA ZONA	
Zona 1	
Zona 2	
◀ Visualizza ▶	



Selezionare la zona da visualizzare
(Es.: Zona 1)



per confermare

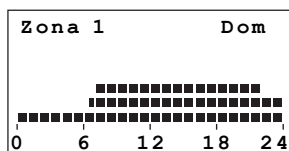

CLEAR per tornare alla pagina precedente;
tenere premuto per tornare alla pagina iniziale

5 MENÙ PRINCIPALE



5.5 Impostazioni

Questo menù consente di modificare le impostazioni disponibili.

Per accedere al menù IMPOSTAZIONI:

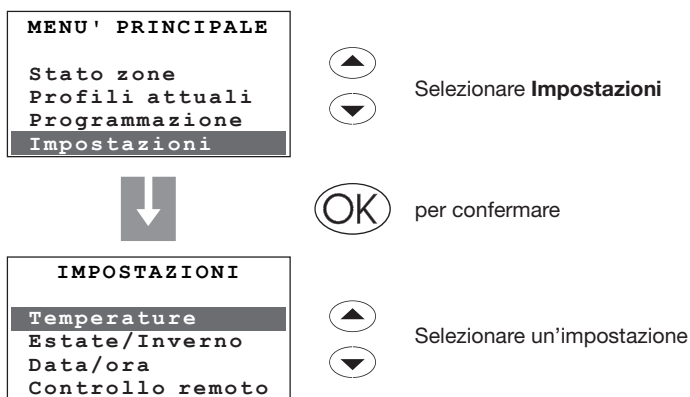

Impostazioni presenti:

- **Temperature** - livelli di temperatura T1, T2, T3, e Antigelo/Protezione termica
- **Estate / Inverno** - modalità di funzionamento impianto
- **Data / ora** - data e ora correnti
- **Controllo remoto** - abilita/disabilita controllo remoto
- **Codice utente** - abilita/disabilita e consente la modifica
- **Contrasto** - modifica contrasto display
- **Diagnostica** - interrogazione e stato dei dispositivi dell'impianto
- **Sensori** - interrogazione dei sensori di temperatura e regolazione soglia
- **Gestione contatti** - abilita/disabilita i contatti ausiliari
- **Chiller** - interrogazione e stato dei Chiller Climaveneta presenti nell'impianto

5 MENÙ PRINCIPALE

Modalità

Stato zone

Profili attuali

Programmazione

Impostazioni

Manutenzione

5.5.1 Temperature

Consente di impostare per ogni zona i livelli di temperatura T1, T2, T3, Antigelo/Protezione Termica (di base uguali per tutte le zone).

IMPOSTAZIONI	
Temperature	
Estate/Inverno	
Data/ora	
Controllo remoto	



Selezionare **Temperature**



per confermare

TEMPERATURE	
TUTTE LE ZONE	
Zona 1	
Zona 2	
Zona 3	



Selezionare TUTTE LE ZONE o la zona desiderata (es.: Zona 1)



per confermare

TEMPERATURE	
T*:	07.0C
T1:	18.0C
T2:	20.0C
T3:	22.0C



Selezionare il livello di temperatura da modificare (Es.: T1)



per confermare

TEMPERATURE	
T*:	07.0C
T1:	15.0C
T2:	20.0C
T3:	22.0C

① ② ③

④ ⑤ ⑥

⑦ ⑧ ⑨

* 0 #

Impostare la temperatura desiderata servendosi dei tasti numerici o incremento di $\pm 0.5^{\circ}\text{C}$



per confermare

CLEAR per tornare alla pagina precedente;
tenere premuto per tornare alla pagina iniziale



I valori di temperatura impostabili vanno da 3 a 40°C, per garantire un corretto funzionamento del sistema la centrale controlla automaticamente che T3 sia superiore a T2, e T2 superiore a T1.

5 MENÙ PRINCIPALE



5.5.2 Estate/Inverno

Consente di impostare il modo di funzionamento dell'impianto Raffrescamento o Riscaldamento.

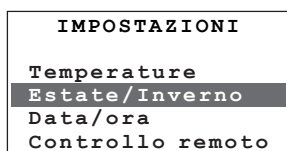

Selezionare **Estate / Inverno**



per confermare



sul display viene fornita l'indicazione dello stato attuale: **Inverno**



per confermare



un **BIP** segnala l'avvenuta modifica

sul display viene fornita l'indicazione della nuova impostazione: **Estate**



Dopo la commutazione l'impianto si imposta in modalità Antigelo/Protezione Termica.



Prima di effettuare la commutazione, eseguire sull'impianto idraulico tutte le operazioni necessarie per il corretto funzionamento.

5 MENÙ PRINCIPALE

Modalità

Stato zone

Profili attuali

Programmazione

Impostazioni

Manutenzione

5.5.3 Data/ora

Consente di impostare data e ora correnti.

Impostare correttamente Data/ora è importante affinché si possano eseguire correttamente i programmi settimanali impostati.

IMPOSTAZIONI

Temperature
Estate/Inverno
Data/ora
Controllo remoto



Selezionare **Data / ora**



per confermare

CAMBIO ORA/DATA

Ora: 06:27
Data: 01/10/03
Mer 01 Ott 06:29



Digitare Ora e data



CAMBIO ORA/DATA

Ora: 11:30
Data: 05/11/03
Mer 01 Ott 06:29



I tasti spostano di una cifra la selezione



I tasti cambiano riga ora/data e viceversa



per confermare

IMPOSTAZIONI

Temperature
Estate/Inverno
Data/ora
Controllo remoto

CLEAR per tornare alla pagina precedente;
tenere premuto per tornare alla pagina iniziale

5 MENÙ PRINCIPALE



5.5.4 Controllo remoto

Consente di abilitare/disabilitare il controllo remoto per la telegestione (utente) e la teleassistenza (installatore) tramite portale My Home. La telegestione permette di conoscere e controllare da remoto la temperatura di ogni zona. La teleassistenza permette di programmare la centrale e di eseguire la diagnostica di impianto da remoto.

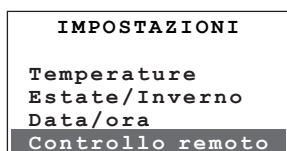

Selezionare **Controllo remoto**



per confermare

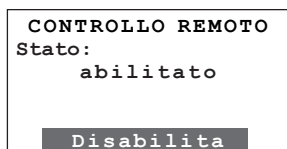

sul display viene fornita l'indicazione dello stato attuale: **abilitato**



per confermare

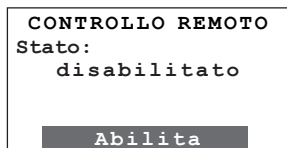

sul display viene fornita l'indicazione della nuova impostazione: **disabilitato**



Come impostazione di fabbrica il controllo remoto è **abilitato**



Per utilizzare il Touch Screen (art. L/N/NT 4683) è necessario abilitare il controllo remoto, se il controllo remoto è disabilitato, la centrale non gestisce il contatto "Remote" né esegue alcun comando ricevuto dal bus.

5 MENÙ PRINCIPALE

Modalità

Stato zone

Profili attuali

Programmazione

Impostazioni

Manutenzione

5.5.5 Codice utente

Consente di abilitare/disabilitare e personalizzare il codice utente (di base **00000**)

IMPOSTAZIONI

Estate/Inverno
Data/ora
Controllo remoto
Codice utente



Selezionare **Codice utente**



per confermare

CODICE UTENTE
Stato:
disabilitato

Abilita

sul display viene fornita l'indicazione dello stato attuale: **disabilitato**



per confermare e cambiare lo stato

CODICE UTENTE

Attuale: 00000

Nuovo: 22222

Memorizza



digitare il **Nuovo** codice (cinque cifre) oppure confermare il codice **Attuale**



per Memorizzare

CODICE UTENTE
Stato:
abilitato

Disabilita

sul display viene fornita l'indicazione della nuova impostazione: **abilitato**

Da questo momento per accedere al menù Principale sarà necessario digitare il codice utente impostato.

Sono disponibili le seguenti funzioni:

Disabilita

Consente di disabilitare il Codice utente

Modifica

Consente di modificare il Codice utente

Selezionare la funzione desiderata tramite i tasti



Se viene impostato un nuovo codice utente, si consiglia di trascriverlo nell'apposito spazio a pag. 25 del Manuale d'uso.

5 MENÙ PRINCIPALE



5.5.6 Contrasto

Consente di impostare il livello di contrasto del display grafico.

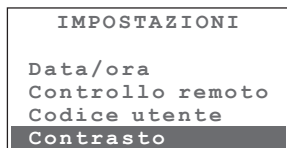
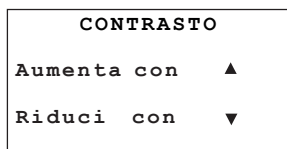
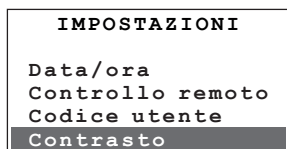

Selezionare **Contrasto**



per confermare



regolare il livello di contrasto desiderato



per confermare

CLEAR per tornare alla pagina precedente;
tenere premuto per tornare alla pagina iniziale

5 MENÙ PRINCIPALE



5.5.7 Diagnostica

Consente, in caso di malfunzionamento di una o più zone dell'impianto di effettuare una verifica dei dispositivi installati nelle singole zone.

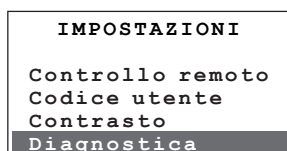

Selezionare **Diagnostica**



per confermare

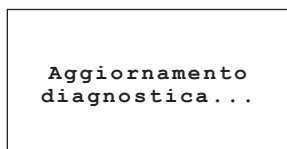

La centrale esegue in automatico un aggiornamento dello stato diagnostico dell'impianto

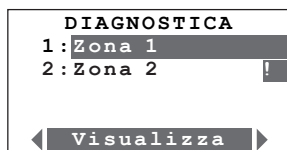

Selezionare **la zona**



Per la zona selezionata sono disponibili le seguenti funzioni:



Consente di visualizzare lo stato della zona selezionata



Consente di interrogare la sonda della zona selezionata

Selezionare la funzione desiderata tramite i tasti

Se durante la fase di diagnostica vengono rilevati dei Chiller Climaveneta, compare la scritta "DIAGN. CHILLER" che permette di verificarne lo stato.



Il simbolo "!" permette di individuare la zona che presenta problemi di funzionamento.

5 MENÙ PRINCIPALE



5.5.7.1 Visualizza

Consente di visualizzare in dettaglio le informazioni diagnostiche della zona desiderata.

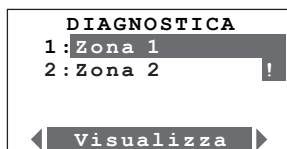

Selezionare la zona
(Es.: Zona 1)



per confermare

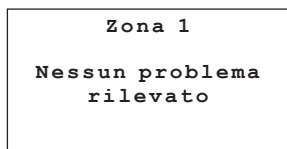

Sul display viene indicato lo stato della zona



per tornare alla pagina precedente

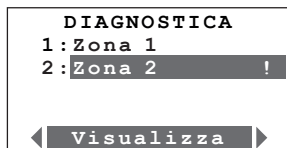

Selezionare la zona
(Es.: Zona 2)



per confermare

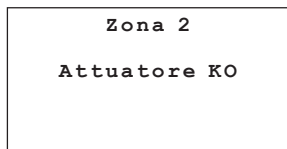

Sul display viene indicato lo stato della zona

CLEAR per tornare alla pagina precedente;
tenere premuto per tornare alla pagina iniziale



Per la soluzione di possibili malfunzionamenti, consultare la sezione "Come risolvere eventuali problemi" nel presente manuale.

5 MENÙ PRINCIPALE

Modalità

Stato zone

Profili attuali

Programmazione

Impostazioni

Manutenzione

5.5.7.2 Aggiorna

Consente di effettuare un'interrogazione della sonda per aggiornare lo stato della zona selezionata.

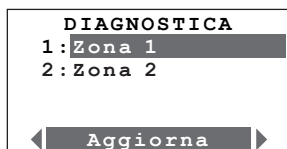

Selezionare la zona
(Es.: Zona 1)



per confermare

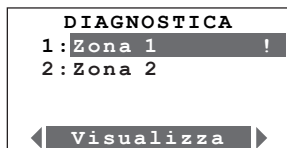
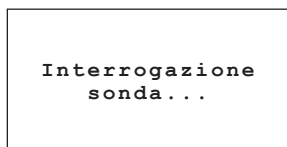

CLEAR per tornare alla pagina precedente;
 tenere premuto per tornare alla pagina iniziale

5 MENÙ PRINCIPALE



5.6 Sensori

Consente di visualizzare l'elenco dei sensori configurati tramite il software TIThermo e di modificarne il valore di soglia impostato.

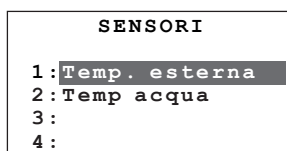

Selezionare il sensore
(Es.: Temp. esterna)



per confermare

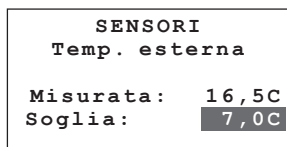

Sul display vengono indicati la temperatura misurata e, se previsto dalla programmazione effettuata con TIThermo, il valore di soglia impostato



per impostare il nuovo valore

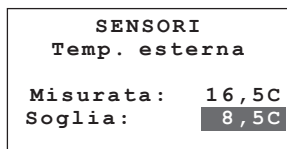

per confermare l'impostazione



per tornare alla pagina precedente;
tenere premuto per tornare alla pagina iniziale

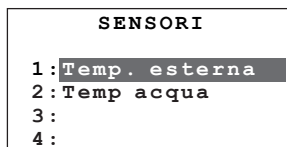

5 MENÙ PRINCIPALE

Modalità

Stato zone

Profili attuali

Programmazione

Impostazioni

Manutenzione

5.7 Gestione contatti

Consente di abilitare/disabilitare la gestione dei contatti ausiliari (es. contatti finestre).

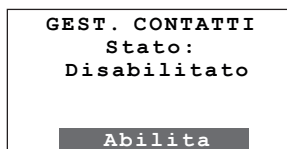

per cambiare l'impostazione attuale

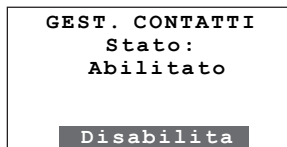

per tornare alla pagina precedente;
tenere premuto per tornare alla pagina iniziale

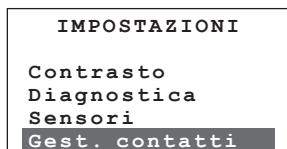

5 MENÙ PRINCIPALE



5.8 Chiller

Questo menù appare unicamente se nell'impianto sono stati rilevati uno o più Chiller Climaveneta.

Permette di modificare l'impostazione dei Chiller presenti nell'impianto.

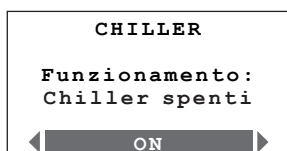

Selezionare la modalità di funzionamento tra le seguenti

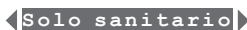

per confermare

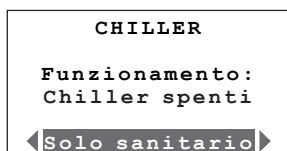

per tornare alla pagina precedente;
tenere premuto per tornare alla pagina iniziale

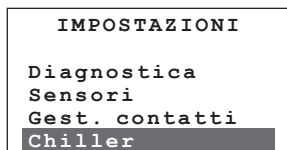

5 MENÙ PRINCIPALE

Modalità

Stato zone

Profili attuali

Programmazione

Impostazioni

Manutenzione

5.9 Manutenzione

Per impedire che utenti inesperti possano modificare le impostazioni compromettendo il funzionamento della Centrale termoregolazione, l'accesso a questo menù è protetto dal **Codice manutenzione** (di base **12345**).

Per accedere al menù **MANUTENZIONE**:

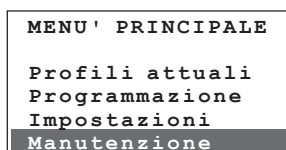

Selezionare il menù **Manutenzione**



per confermare



Digitare il codice manutenzione
(di base **12345**)



per confermare

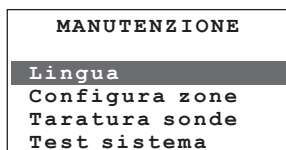

Voci presenti:

- **Lingua** - Consente di selezionare la lingua (di base Italiano)
- **Configura zone** - Consente di configurare le zone dell'impianto
- **Taratura sonde** - Consente di variare la temperatura misurata
- **Test sistema** - Consente di effettuare manutenzione o verifiche sull'impianto
- **Codice manutenzione** - Consente di personalizzare il codice manutenzione
- **Reset totale** - Esegue un reset totale della centrale

5 MENÙ PRINCIPALE

Modalità

Stato zone

Profili attuali

Programmazione

Impostazioni

Manutenzione

5.9.1 Lingua

Consente di selezionare la lingua in cui vengono visualizzati i messaggi sul display.

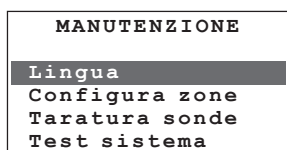

Selezionare **Lingua**



per confermare

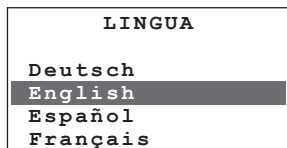
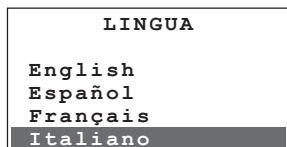

Selezionare la lingua desiderata
(es.: English)



per confermare

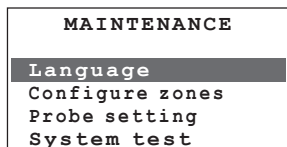

CLEAR per tornare alla pagina precedente,
tenere premuto per tornare alla pagina iniziale

5 MENÙ PRINCIPALE

Modalità

Stato zone

Profili attuali

Programmazione

Impostazioni

Manutenzione

5.9.2 Configura zone

Consente di eseguire l'apprendimento dell'impianto e gestire la configurazione delle zone.

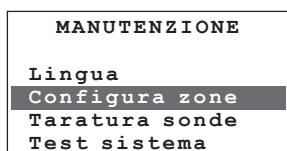

Selezionare **Configura zone**



per confermare

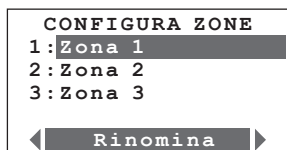

Selezionare la zona



Per la zona selezionata sono disponibili le seguenti funzioni:

◀ Rinomina ▶

Consente di rinominare la zona selezionata

◀ Attuatori ▶

Consente di configurare gli attuatori per la zona selezionata

◀ Pompe ▶

Consente di configurare le pompe per la zona selezionata

◀ Elimina ▶

Consente di eliminare la zona selezionata

◀ Azzera tutto ▶

Consente di azzerare la configurazione di tutte le zone

◀ Apprendimento ▶

Esegue la ricercare tutte le zone presenti nell'impianto

◀ Invia ▶

Esegue la configurazione delle zone in base alle impostazioni ricevute da PC attraverso il software TITHERMO.

Selezionare la funzione desiderata tramite i tasti ◀ ▶

5 MENÙ PRINCIPALE

Modalità

Stato zone

Profili attuali

Programmazione

Impostazioni

Manutenzione

5.9.2.1 Rinomina

Questa funzione consente di personalizzare il nome della zona selezionata (max 13 caratteri).

CONFIGURA ZONE
 1: Zona 1
 2: Zona 2
 3: Zona 3

◀ Rinomina ▶



Selezionare la zona



per confermare

CONFIGURA ZONE
 1: Soggior
 2: Zona 2
 3: Zona 3

Memorizza

① ② ③

④ ⑤ ⑥

Digitare il nome della zona
(Es.: Soggiorno)

⑦ ⑧ ⑨

* 0 #



per confermare

CONFIGURA ZONE
 1: Soggiorno
 2: Zona 2
 3: Zona 3

◀ Attuatori ▶

CLEAR per tornare alla pagina precedente,
 tenere premuto per tornare alla pagina iniziale

5 MENÙ PRINCIPALE

Modalità

Stato zone

Profili attuali

Programmazione

Impostazioni

Manutenzione

5.9.2.2 Attuatori

Consente di completare la configurazione delle zone, indicando:

- quali attuatori sono installati per Riscaldamento
- quali attuatori sono installati per Raffrescamento
- che tipo di carico viene gestito dalla zona



Questa procedura deve essere effettuata solo in caso di configurazione Standard (vedi Guida My Home - sezione "Configurazione sonda").

```

CONFIGURA ZONE
1: Soggiorno
2: Zona 2
3: Zona 3
Attuatori
    
```



Selezionare **la zona**



(Es.: Soggiorno)



per confermare

```

Soggiorno
01: RISCALDAM.
02: -----
03: -----
Non collegato
    
```



Per ogni attuatore presente nell'elenco è possibile selezionare una delle seguenti opzioni:

◀ Non collegato ▶

Non presente sull'impianto

◀ Riscaldamento ▶

Viene utilizzato per gestire l'impianto di Riscaldamento

◀ Raffrescamento ▶

Viene utilizzato per gestire l'impianto di Raffrescamento

◀ Risc.e Raffr. ▶

Viene utilizzato per gestire sia l'impianto di Riscaldamento che l'impianto di Raffrescamento (es.: fan-coil 2 tubi)



per confermare

```

Soggiorno
09: -----
RISC ON/OFF
RAFF APRI/CHIUDI
FAN-COIL 3V
    
```



Le ultime due voci del menù



consentono di selezionare il tipo di carico gestito



segue

5 MENÙ PRINCIPALE



Soggiorno
 09: -----
RISC ON/OFF
RAFF APRI/CHIUDI
 ◀ **FAN-COIL 3V** ▶



Per ogni funzionamento è possibile selezionare una delle seguenti opzioni:

◀ **ON/OFF** ▶

Carico gestito da un solo contatto (es.: valvola termostatica)

◀ **APRI/CHIUDI** ▶

Carico gestito da due relè interbloccati (es.: valvola motorizzata con contatto di apertura e contatto di chiusura)

◀ **FAN-COIL 3V** ▶

Fan-coil con controllo di una valvola e selettore fino a 3 velocità

◀ **GATEWAY** ▶

Interfaccia per FAN-COIL Climaveneta



Soggiorno
Test zona...



Alla pressione del tasto CLEAR viene inviata alla zona la configurazione impostata

La centrale esegue un test della configurazione, terminato il quale, possono esserci due segnalazioni di errore:

Soggiorno
Configurazione non valida

Si sta cercando di impostare in una sonda una configurazione di attuatori non consentita (esempio: attuatori di tipo diverso per la stessa funzione)



CONFIGURA ZONE
 1: **Soggiorno**
 2: Zona 2
 3: Zona 3
 ▶ **Pompe** ◀

Soggiorno
ERRORE
Verifica la configurazione della sonda

Verificare che la sonda sia in configurazione standard (MOD= CEN) e riprovare; se non c'è questo tipo di configurazione, la sonda non è configurabile via centrale.

5 MENÙ PRINCIPALE

Modalità

Stato zone

Profili attuali

Programmazione

Impostazioni

Manutenzione

5.9.2.3 Pompe

Consente di completare la configurazione delle zone, indicando quali pompe deve controllare la zona e con quale ritardo.



Questa funzione può essere utilizzata solo se la sonda è configurata con il configuratore CEN nella sede P.

CONFIGURA ZONE

1: Soggiorno

2: Zona 2

3: Zona 3

Pompe



Selezionare la **zona**



(Es.: Soggiorno)



Confermare premendo **OK**

Soggiorno

01: RISCALDAM.

02: -----

03: -----

Non collegato



Per ogni attuatore presente nell'elenco è possibile selezionare una delle seguenti opzioni:

Non collegato

Non presente sull'impianto o non gestito dalla zona selezionata

Riscaldamento

Viene utilizzato per gestire l'impianto di Riscaldamento

Raffrescamento

Viene utilizzato per gestire l'impianto di Raffrescamento

Risc. e Raffr.

Viene utilizzato per gestire sia l'impianto di Riscaldamento che l'impianto di Raffrescamento



Confermare premendo **OK**

Soggiorno

09: -----

RISC 1

RAFF 0

0



Le ultime due voci del menù consentono di selezionare il ritardo di attivazione della pompa



Selezionare i minuti di ritardo



Per confermare

segue

5 MENÙ PRINCIPALE



Soggiorno
Test zona...



CONFIGURA ZONE
1: **Soggiorno**
2: Zona 2
3: Zona 3
Pompe



Ala pressione del tasto **CLEAR** viene inviata alla zona la configurazione impostata

La centrale invia la configurazione:

Può esserci la seguente segnalazione di errore

Soggiorno
ERRORE
Verifica la
configurazione
della sonda

Verificare che la sonda sia in configurazione ($P = CEN$) e riprovare; se non c'è questo tipo di configurazione, la sonda non è configurabile via centrale.

5 MENÙ PRINCIPALE

Modalità

Stato zone

Profili attuali

Programmazione

Impostazioni

Manutenzione

5.9.2.4 Elimina

Consente di eliminare dalla configurazione la zona selezionata.

CONFIGURA ZONE
 1: **Soggiorno**
 2: Zona 2
 3: Zona 3
 ◀ Elimina ▶



Selezionare la zona



per confermare

Eliminazione di Soggiorno
 SI NO



Selezionare SI



per confermare

CONFIGURA ZONE
 2: **Zona 2**
 3: Zona 3
 4: Zona 4
 ◀ Elimina ▶

CLEAR per tornare alla pagina precedente, tenere premuto per tornare alla pagina iniziale



Le zone eliminate non vengono più gestite dalla Centrale.

5 MENÙ PRINCIPALE

Modalità

Stato zone

Profili attuali

Programmazione

Impostazioni

Manutenzione

5.9.2.5 Azzera tutto

Consente di cancellare la configurazione memorizzata di tutte le zone.

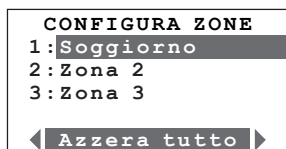

per confermare

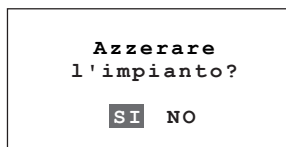

Selezionare SI



per confermare

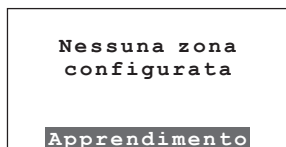
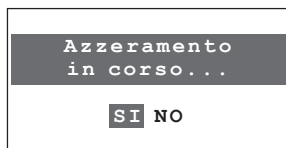

**Da questo momento la Centrale non gestisce più nessuna zona.
 Per ripristinare il funzionamento del sistema,
 effettuare l'APPRENDIMENTO delle zone.**

5 MENÙ PRINCIPALE

Modalità

Stato zone

Profili attuali

Programmazione

Impostazioni

Manutenzione

5.9.2.6 Apprendimento

Esegue la ricerca di tutte le zone presenti nell'impianto.

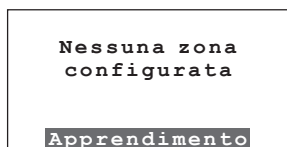

per confermare

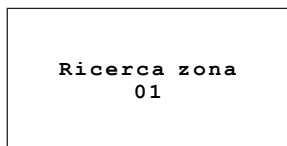

La centrale esegue la ricerca delle zone da 1 a 99. In funzione dell'estensione dell'impianto, questa operazione può richiedere anche alcuni minuti.

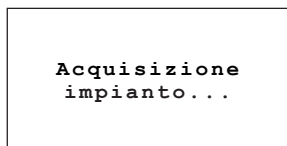
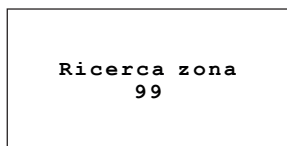

Terminata la ricerca torna al menù Configura zone



CLEAR per tornare alla pagina precedente, tenere premuto per tornare alla pagina iniziale

5 MENÙ PRINCIPALE

Modalità

Stato zone

Profili attuali

Programmazione

Impostazioni

Manutenzione

5.9.2.7 Invia

Esegue l'invio delle impostazioni di attuatori e pompe a tutte le zone configurate.

```

CONFIGURA ZONE
1: Soggiorno
2: Zona 2
3: Zona 3
    
```

◀ Invia ▶



per confermare

Soggiorno

La centrale invia la configurazione impostata alle zone presenti nell'impianto



Zona 3

Durante la fase d'invio, potrebbe essere visualizzato il messaggio:

```

Soggiorno
ERRORE
Verifica la
configurazione
della sonda
    
```

Premendo il tasto **CLEAR** si annulla l'invio della configurazione
Premendo il tasto **OK** si passa alla zona successiva



Terminato l'invio, torna al menù Configura zone

```

CONFIGURA ZONE
1: Soggiorno
2: Zona 2
3: Zona 3
    
```

◀ Invia ▶

5 MENÙ PRINCIPALE

Modalità

Stato zone

Profili attuali

Programmazione

Impostazioni

Manutenzione

5.9.3 Taratura sonde

Consente di allineare la temperatura misurata dalle sonde ad un valore rilevato con altri dispositivi (termometro,..) per garantire una maggiore precisione nel funzionamento dell'impianto.

MANUTENZIONE

Lingua

Configura zone

Taratura sonde

Test sistema



Selezionare **Taratura sonde**



TARATURA SONDA

Zona 1

Zona 2



per confermare



selezionare la zona
(Es.: Zona 2)



TARATURA SONDA

Zona 2

Misurata 20.0C

Nuova 22.5C



per confermare



impostare la temperatura effettiva misurata
nell'ambiente (incremento di $\pm 0.1^{\circ}\text{C}$)



Taratura sonda

Zona 2

in corso



per confermare



TARATURA SONDA

Zona 1

Zona 2

CLEAR per tornare alla pagina precedente,
tenere premuto per tornare alla pagina iniziale

5 MENÙ PRINCIPALE

Modalità

Stato zone

Profili attuali

Programmazione

Impostazioni

Manutenzione

5.9.4 Test sistema

Consente di mettere il sistema in **Test** (OFF tutto il sistema) per poter verificare l'impianto, disabilita automaticamente tutti i comandi (compresi quelli da remoto).

MANUTENZIONE
 Lingua
 Configura zone
 Taratura sonde
Test sistema



Selezionare **Test sistema**



per confermare

**Verificare
 l'impianto**
 Esci con CLEAR

M30	PIC	HW
00.10	01.07	0.1

Sul display sono indicate le versioni software e hardware della Centrale:

M30 - versione firmware

PIC - versione firmware interfaccia SCS

HW - versione hardware



per uscire e tornare alla pagina precedente

MANUTENZIONE
 Lingua
 Configura zone
 Taratura sonde
Test sistema

5 MENÙ PRINCIPALE

Modalità

Stato zone

Profili attuali

Programmazione

Impostazioni

Manutenzione

5.9.5 Codice manutenzione

Consente di impostare un nuovo Codice manutenzione

MANUTENZIONE

Configura zone
Taratura sonde
Test sistema
Codice manutenz.



Selezionare **Codice manutenz.**



per confermare

CODICE MANUTENZ.

Attuale: 12345
Nuovo: 1234**5**
Memorizza



Digitare il nuovo codice manutenzione
(Es.: 55555)

CODICE MANUTENZ.

Attuale: 12345
Nuovo: 5555**5**
Memorizza



per confermare

MANUTENZIONE

Lingua
Configura zone
Taratura sonde
Test sistema

Da questo momento per accedere al menù Manutenzione sarà necessario digitare il nuovo codice impostato.



Se viene impostato un nuovo CODICE MANUTENZIONE, si consiglia di trascriverlo nell'apposito spazio a pag. 23 del presente manuale.

5 MENÙ PRINCIPALE

Modalità

Stato zone

Profili attuali

Programmazione

Impostazioni

Manutenzione

5.9.6 Reset totale

Consente di eseguire un reset totale della Centrale, tutte le impostazioni andranno perse e saranno ripristinate le impostazioni di fabbrica (vedere pag.10 del manuale).

MANUTENZIONE
 Taratura sonde
 Test sistema
 Codice manutenz.
Reset totale



Selezionare **Reset totale**



per confermare

ATTENZIONE!
 I programmi
 andranno persi!
 Eseguire?
SI NO



Selezionare **SI**



per confermare

**RESET
 IN CORSO...**

L'operazione di Reset richiede circa 30 secondi.



MANUTENZIONE
Lingua
 Configura zone
 Taratura sonde
 Test sistema

CLEAR per tornare alla pagina precedente;
 tenere premuto per tornare alla pagina iniziale



Con questa operazione si perde la configurazione dell'impianto e tutte le programmazioni eseguite!

5 MENÙ PRINCIPALE

Modalità

Stato zone

Profili attuali

Programmazione

Impostazioni

Manutenzione

5.9.7 Automazioni

Tramite il software TiThermo è possibile programmare delle automazioni che si attiveranno al verificarsi di determinate condizioni di temperatura rilevate da gateway o sensori presenti nell'impianto. In questo menù è possibile abilitare o disabilitare le automazioni programmate.

MANUTENZIONE

Test sistema
Codice manutenz.
Reset totale
Automazioni

 Selezionare **Automazioni**

AUTOMAZIONI

1: Automazione 01
2: Automazione 02
3: Automazione 03

Disabilita



per confermare

 Selezionare l'automazione
(le automazioni attive sono identificate
dal numero evidenziato).

AUTOMAZIONI

1: Automazione 01
2: Automazione 02
3: Automazione 03

Abilita



per disabilitare l'Automazione



MANUTENZIONE

Test sistema
Codice manutenz.
Reset totale
Automazioni

 per tornare alla schermata precedente;
tenere premuto per tornare alla pagina iniziale

APPENDICE

Dati tecnici

Alimentazione	da bus SCS: da 18V a 28V
Assorbimento (Max)	75 mA
Temperatura operativa	5 a 40°C
Dimensioni	L= 140 H= 210 P= 35
Grado di protezione	IP 30

Riferimenti normativi

L'articolo oggetto del manuale è provvisto della Dichiarazione CE di Conformità secondo i requisiti indicati di seguito:

BTicino S.p.A. con sede in Via Messina, 38 - 20154 Milano

dichiara che il prodotto con l'articolo: **3550**

rispetta le seguenti norme: **EN60950 EN50090-2-2**

Anno di approvazione marcatura CE secondo la direttiva indicata: 2004

Servizio Tecnico Clienti

BTicino risponde del perfetto funzionamento del dispositivo solo se installato a regola d'arte rispettando le indicazioni del manuale d'installazione del prodotto.

In caso di malfunzionamento contattare il Centro Assistenza Tecnica Autorizzato.

Per conoscere il nominativo del CAT di zona telefonare al:

Numero verde BTicino 800.837.035

Oppure visitare il sito **www.bticino.it**

Garanzia: i termini di garanzia sono riportati sul documento "Condizioni di Fornitura del Servizio di Assistenza Tecnica BTicino". Tale documento può essere richiesto al CAT, al numero verde BTicino, oppure scaricato dal sito www.bticino.it



COME RISOLVERE EVENTUALI PROBLEMI

PROBLEMA	RISOLUZIONE
Segnalazione di batteria giusta	Verificare il corretto collegamento della batteria. Se il problema persiste, sostituire la batteria.
Una zona non regola correttamente	Verificare se sono stati segnalati problemi (Impostazioni >Diagnostica >Aggiorna)
Una zona segnala “Errore su sonda”	La sonda non risponde; verificare che sia correttamente collegata (led verde acceso fisso o lampeggiante lentamente) e configurata (corretto numero di zona e modalità)
Una zona segnala “Attuatore KO”	Un attuatore non risponde: - verificare che gli attuatori siano correttamente collegati e configurati (provare gli attuatori con il tasto locale); - nel caso di configurazione standard, verificare di aver eseguito la corretta configurazione in centrale (Manutenzione >Configura zone> Configura)
Una zona segnala “Sonda slave KO”	Una sonda slave non risponde: - verificare che sia correttamente collegata (led verde acceso fisso o lampeggiante lentamente) e configurata (corretto numero di zona, modalità SLA); - verificare la corretta configurazione degli slave da gestire sulla sonda Master.
Una zona segnala “T fuori limiti”	La sonda sta misurando una temperatura troppo bassa o troppo alta: - verificare che sia installata correttamente (ad es. non troppo vicino a fonti di calore); - effettuare la taratura della sonda (Manutenzione >Taratura sonde) misurando con un termometro la temperatura ambiente; - se il problema persiste, sostituire la sonda.
Una zona segnala “R/W EEPROM KO”	Si è verificato un problema interno sulla sonda; sostituire la sonda.
Una zona segnala “Pompa KO”	L’attuatore configurato per il controllo della pompa di circolazione (Zona=00) non risponde: - verificare che l’attuatore sia correttamente collegato e configurato (provare l’attuatore con il tasto locale); - verificare la corretta configurazione della gestione pompa sulla sonda.

CONTENTS

1 INTRODUCTION	91
1.1 Warnings and tips	91
1.2 Content of the package	91
2 DESCRIPTION OF THE CONTROL UNIT	92
2.1 General view	92
2.2 Display	93
2.3 Navigation keys	94
2.4 Keypad	94
2.5 Main functions	95
2.6 Mode of operation	95
2.7 Factory settings	96
3 INSTALLATION	97
3.1 Rear view of the Control Unit	97
3.2 Connecting the battery	97
3.3 Wall installation with metal base supplied	98
3.4 Installation in Multibox box	99
4 SWITCHING ON FOR THE FIRST TIME	100
4.1 Selecting the language	100
4.2 Learning the zones	101
4.3 Customising the zones	102
4.4 Configuring the zone actuators	103
4.5 Configuring the pumps	105
4.6 Setting the Date and Time	107
4.7 Setting the Summer/Winter system	108
5 MAIN MENU	109
5.1 Mode	111
5.1.1 Weekly	112
5.1.2 Manual	113
5.1.3 Scenarios	114
5.1.4 Holiday	115
5.1.5 Holidays	116
5.1.6 OFF	117
5.1.7 Antifreeze / Heat protection	118

CONTENS

5.2 Zone state	119
5.3 Current profiles	120
5.4 Programming	121
5.4.1 Weekly	122
5.4.2 Scenarios	132
5.4.3 Holiday	138
5.5 Settings	142
5.5.1 Temperatures	143
5.5.2 Summer/Winter	144
5.5.3 Date/Time	145
5.5.4 Remote control	146
5.5.5 User code	147
5.5.6 Contrast	148
5.5.7 Diagnostics	149
5.6 Sensors	152
5.7 Contacts management	153
5.8 Chiller	154
5.9 Maintenance	155
5.9.1 Language	156
5.9.2 Configure zone	157
5.9.3 Probe setting	167
5.9.4 System test	168
5.9.5 Maintenance code	169
5.9.6 Total reset	170
5.9.7 Automations	171
APPENDIX	172
TROUBLESHOOTING	173

1 INTRODUCTION

1.1 Warnings and tips

Before proceeding with the installation this manual should be read carefully, because the guarantee is automatically cancelled in the event of negligence, incorrect manoeuvre or improper use or if unauthorised people tamper with the circuit.

Moreover it is cancelled when the fault is due to strong accidental overvoltages on the power supply network. Thus if the Control Unit is installed in a place which is subject to violent atmospheric discharges (*storms*), suitable protection must be installed on the power supply line and it must be connected to the earth as rigorously as possible and respecting IEC standards.

1.2 Content of the package

The Control unit package contains:

- Temperature control unit item 3550
- Metal base for wall installation
- Installation manual
- User manual
- CD-ROM containing TITHERMO software and manuals in PDF format

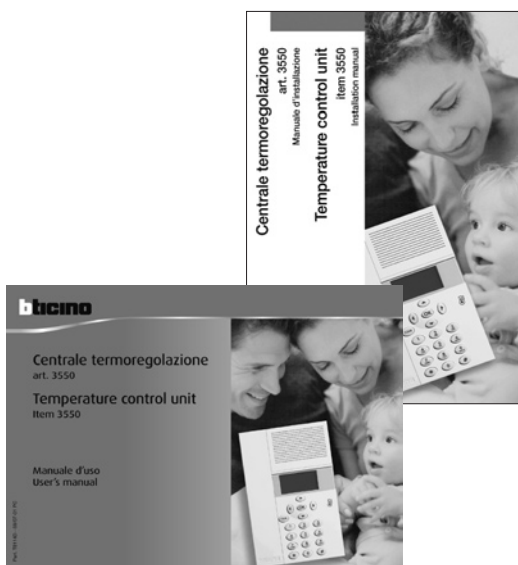
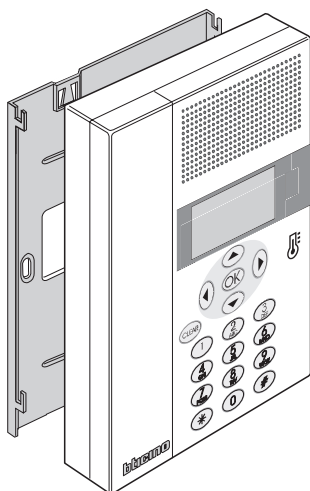

2 DESCRIPTION OF THE CONTROL UNIT

2.1 General view

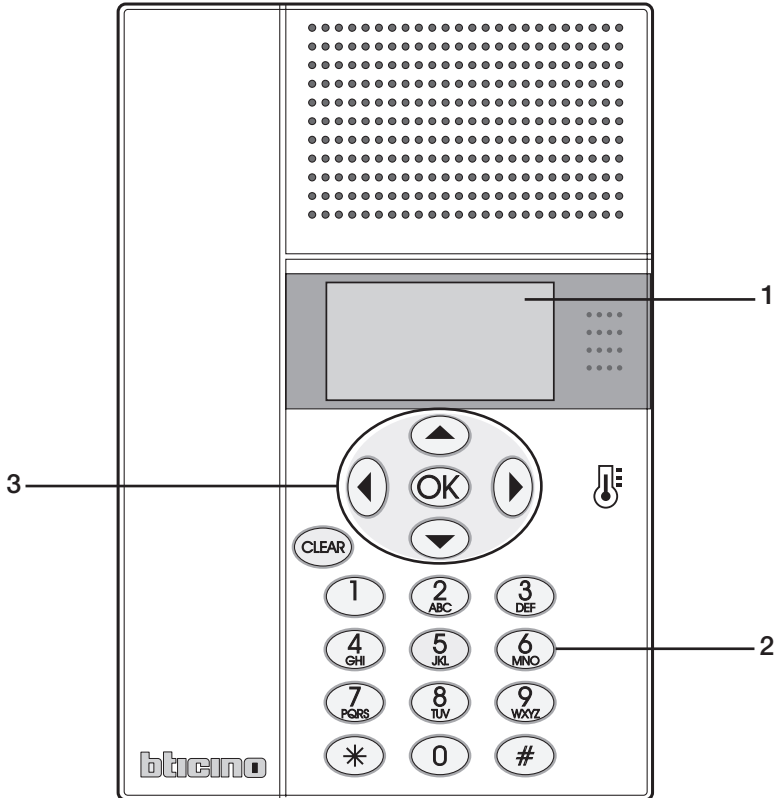

- 1 Alphanumeric display:** displays the messages which guide the programming operations and the events which have occurred (*more information on the next page*).
- 2 Keypad:** is used for manual entry of all those programming operations which require the use of numbers and/or symbols.
- 3 Navigation keypad:** is used to navigate inside the menus, confirms the navigation or cancels the programming operations.

2 DESCRIPTION OF THE CONTROL UNIT

2.2 Display

First page

In normal operation the Control Unit display shows the following information in the first page:

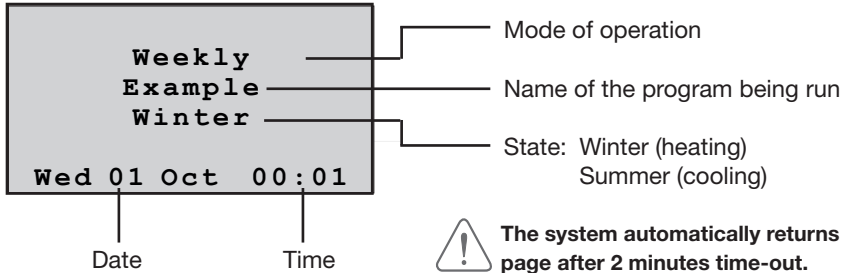

The system automatically returns to the first page after 2 minutes time-out.

Icons

In normal operation, when one of the following modes is set for some zones of the system, the Control Unit display will show their icons in the first page:



One or more zones in OFF



One or more zones in MANUAL



One or more zones in ANTIFREEZE or HEAT PROTECTION

When a mode is applied to ALL THE ZONES of the system the following information is given on the control unit display:

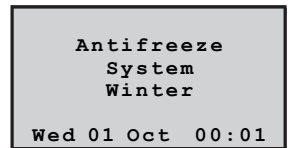
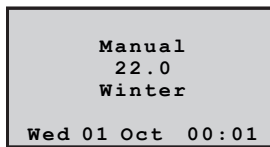
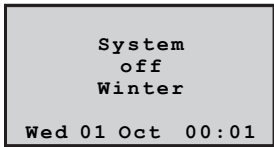

Fault signalling

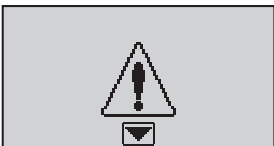

The page indicates a system fault; press any key for direct access to the Diagnostics menu.

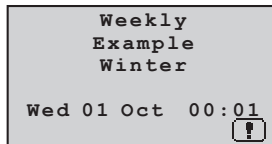

The icon indicates an operation fault in one or more system zones.

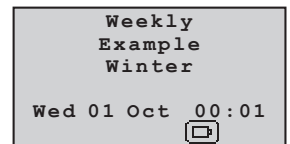

Flat battery

2 DESCRIPTION OF THE CONTROL UNIT

2.3 Navigation keys

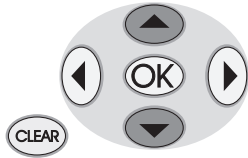

Scroll keys, scrolls the list of items in the menu.

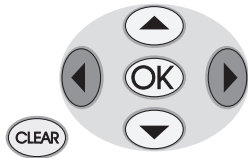

Selection keys, can select functions when they are present in the menu.

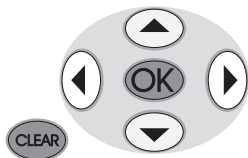
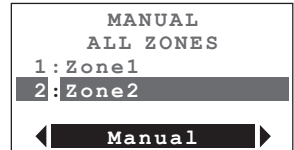

OK - Key to confirm the selection displayed or the data entered
CLEAR - Key to cancel the selection and return to the previous page – keep pressed to quit the Main menu and return to the first page.

2.4 Keypad

Writing text

- ✓ Press a number key several times until the character required is displayed; if the letter required is on the same key as the current one, wait for the cursor to move
- ✓ To insert a space press **0**
- ✓ To move the cursor use the **◀ ▶** keys
- ✓ To cancel a letter position the cursor on it with the **◀ ▶** keys and press **0**
- ✓ To change from lower to upper case keep the key pressed when the character required is displayed, the next characters will be in upper case; follow the same procedure to return to lower case
- ✓ Press **1** to insert punctuation marks

2 DESCRIPTION OF THE CONTROL UNIT

2.5 Main functions

Control Unit item 3550, which can only be used for the BTicino My Home temperature control function, can set the system and modify the mode of operation. Coming with management software with guided menus shown on the display, it lets the user select the mode of operation, display the temperatures of the individual zones and display and change the daily temperature profiles and the weekly programs, while the maintenance menu, reserved for the installer (code protected), gives access to the system settings (zone configuration, system test, total reset...). The Control Unit can manage heating and cooling systems up to a maximum of 99 zones. An input contact can be connected for the remote control (switching from antifreeze mode to automatic mode and vice versa) by telephone actuator.

2.6 Mode of operation

7 different modes of operation can be selected:

Weekly

3 weekly programs can be created for each of the two functions (*heating and cooling*); daily temperature profiles (0h – 24h), different for each day of the week and for each zone, can be defined for each of these.

Manual

In this mode a fixed temperature can be set on the whole system and on the individual zone without time bands; for the individual zone, when the manual mode is switched off operation is automatically reset on the last programming set.

Scenario

In this mode scenarios can be defined which the user activates as required; these scenarios set a predefined temperature in the various zones. Up to 16 scenarios can be defined for *winter* operation and 16 for *summer* operation and for each of these the temperature to be set is associated with each zone.

Holidays

This mode keeps the system in Antifreeze or Heat protection until the date and time set. At the end the weekly program selected is reset.

2 DESCRIPTION OF THE CONTROL UNIT

Holiday

The Holiday mode can select a particular daily profile for a set period. The program is run until the date and time programmed, after which the weekly program selected is reset.

Antifreeze / Heat protection

In this mode the system sets the antifreeze or heat protection temperature on the whole system or on the individual zone on the basis of the current system function (summer/winter).

OFF

When this mode of operation is entered the Control Unit switches off all the selected zones until one of the other modes is reset.

2.7 Factory settings

The temperature control unit is supplied with the following settings:

User code	00000 (DISABLED)
Maintenance code	12345
Language	ITALIAN
Mode	WEEKLY
Program	EXAMPLE (preset)
State	WINTER
Temperatures	Winter: T*: 7.0°C - T1: 18.0°C - T2: 20°C - T3: 22°C Summer: Pt: 35.0°C - T1: 20.0°C - T2: 23°C - T3: 25°C
Remote control	ENABLED

3 INSTALLATION

3.1 Rear view of the Control Unit

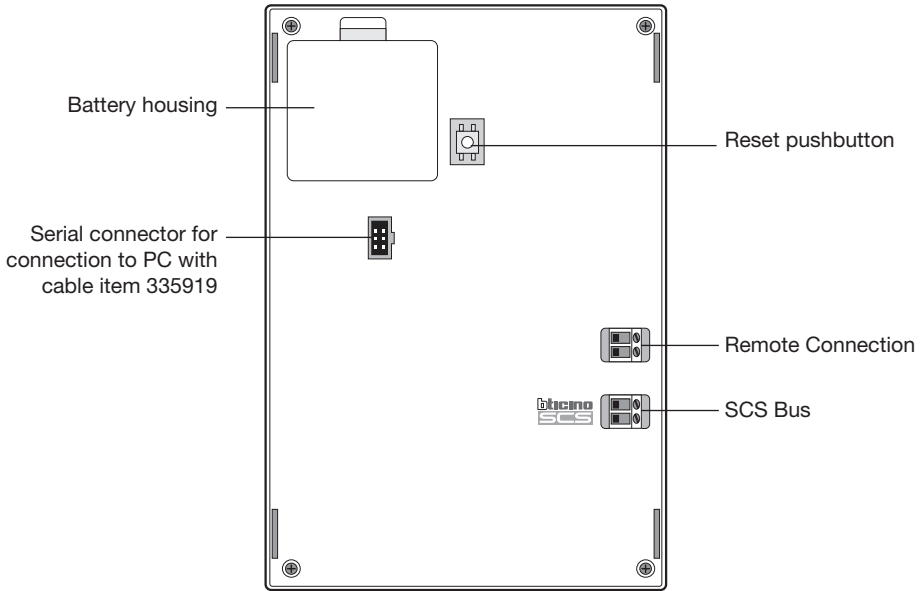

3.2 Connecting the battery

Connect the battery to the connector respecting the polarities indicated inside the housing.

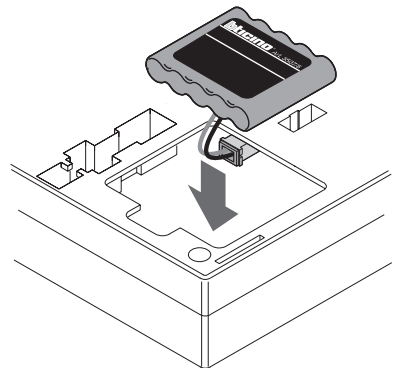
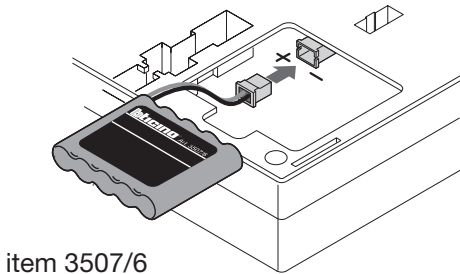

3 INSTALLATION

3.3 Wall installation with metal base supplied

Fasten the base to the wall as indicated in the figure:

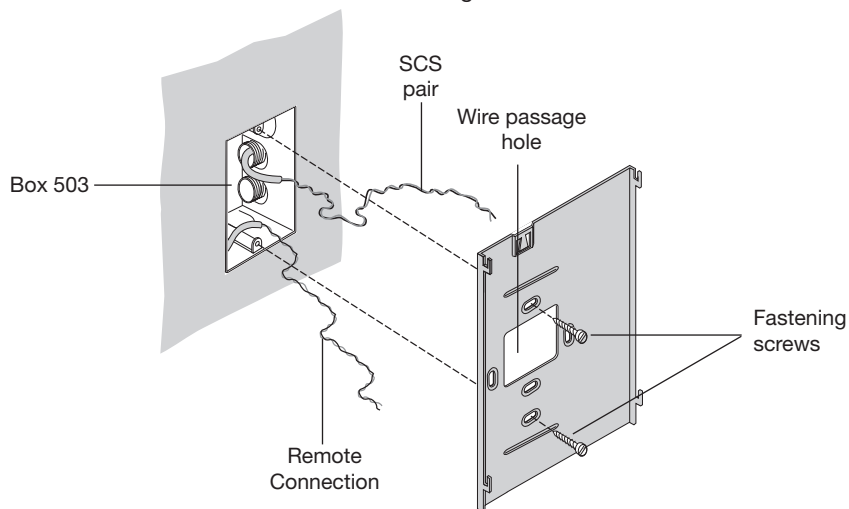

After making all the connections fasten the Control Unit to the base arranging the wires so that they are not damaged.

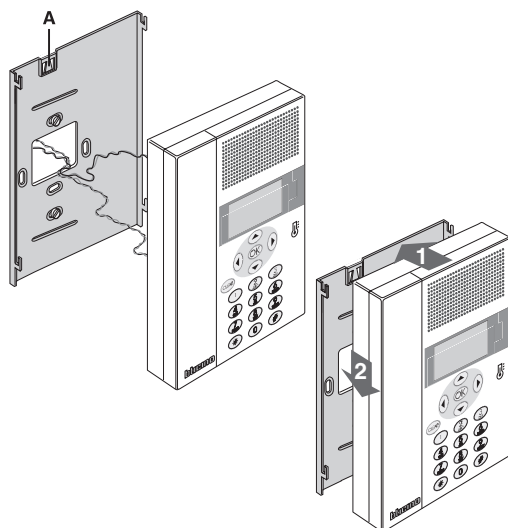

To extract the control unit from the plate lower tongue **A** and press upwards.

3 INSTALLATION

3.4 Installation in Multibox box

Install in the Multibox box following the procedure shown in the figure.

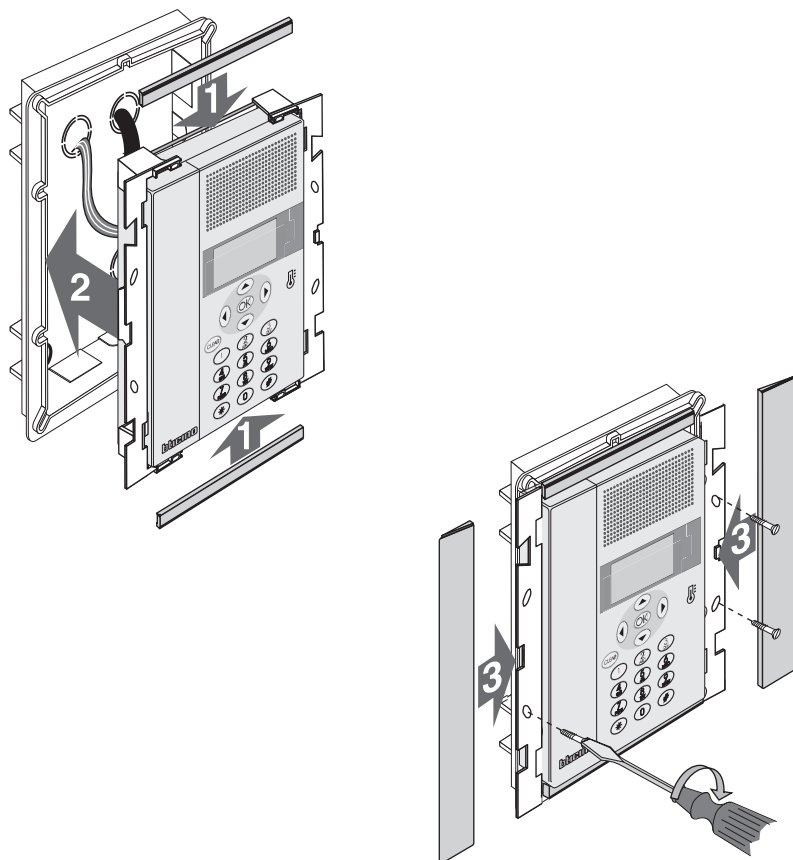

4 SWITCHING ON FOR THE FIRST TIME

When the Control Unit is switched on for the first time it shows the Maintenance menu with the **Language** function highlighted.

To activate the Control Unit and make it operative:

- select the language - **MAINTENANCE - Language**
- perform the zone learning - **MAINTENANCE - Configure zones - Learning**
- customise the zone names - **MAINTENANCE - Configure zones - Rename**
- configure the zone actuators - **MAINTENANCE - Configure zones - Actuators**
- configure the zone pumps - **MAINTENANCE - Configure zones - Pumps**
- enter time and date - **SETTINGS - Date / Time**
- define the system state - **SETTINGS - Summer / Winter**

4.1 Selecting the language

Use this function if the language preset in the factory (Italian) is not that required.

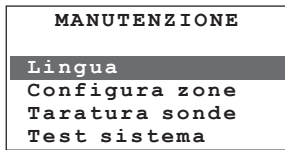

Select **Language**



Confirm by pressing **OK**

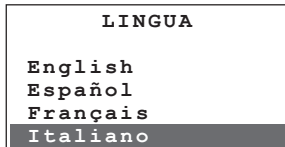

The display shows the language in use (Italian factory setting)

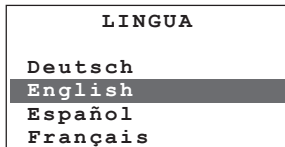

Select the language required (e.g.: English)



Confirm by pressing **OK**

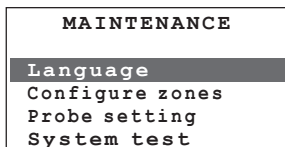

All the Control Unit menus will be displayed in the new language set.

4 SWITCHING ON FOR THE FIRST TIME

4.2 Learning the zones

This function lets the Control Unit recognise all the system zones.

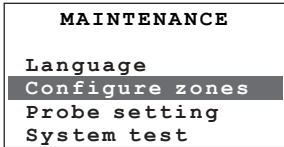

Select **Configure zones**



Confirm by pressing **OK**

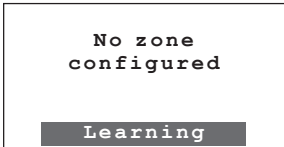

The Control Unit signals "No zone configured" and that the Learning can be performed.



Confirm by pressing **OK**

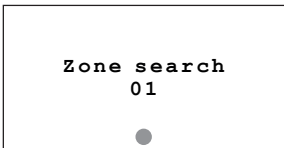

The Control Unit searches the zones from 1 to 99. Depending on the size of the system, this operation may take a few minutes.

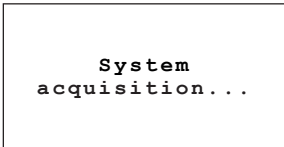
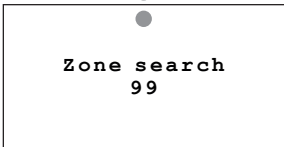

When the search is completed it returns to the Configure zones menu.

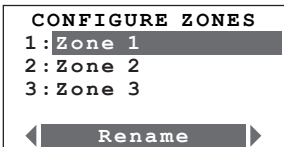

4 SWITCHING ON FOR THE FIRST TIME

4.3 Customising the zones

This function assigns an identification name to each zone.

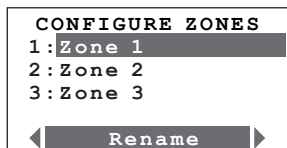

Select the zone to be renamed



(E.g.: Zone 1)



Confirm by pressing **OK**

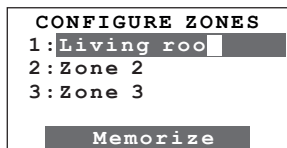

Type the zone name

(E.g.: Living room)



Confirm by pressing **OK**

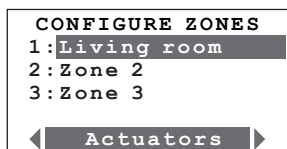

4 SWITCHING ON FOR THE FIRST TIME

4.4 Configuring the zone actuators

This function completes the zone configuration, indicating:

- which actuators are installed for Heating
- which actuators are installed for Cooling
- which type of load the zone manages.



Only perform with Standard configuration

(see My Home Temperature Control Guide “Probe configuration” section).

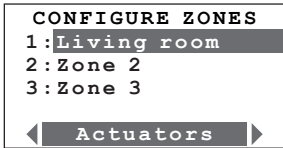

Select the **zone**
(E.g.: Living room)



Confirm by pressing **OK**

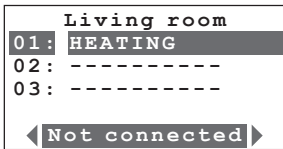

One of the following options can be selected for each actuator in the list:

- ◀ Not connected ▶
- ◀ Heating ▶
- ◀ Cooling ▶
- ◀ Heat. & cool. ▶

- Not present on the system
- Is used to manage the Heating system
- Is used to manage the Cooling system
- Is used to manage both the Heating system and the Cooling system (e.g.: 2-pipe fan coil)



Confirm by pressing **OK**

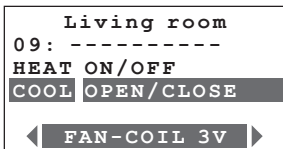

The last two items of the menu can select the type of load managed



cont

4 SWITCHING ON FOR THE FIRST TIME

4.4 Configuring the zone actuators

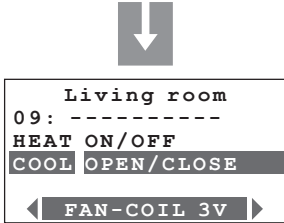

One of the following options can be selected for each operation:



Load managed by just one contact (e.g. thermostatic valve)



Load managed by two interlocked relays (e.g.: motor-driven valve with opening contact and closing contact)



Fan-coil with control of one valve and selector switch up to 3 speeds



Interface for Climaveneta Fan-coil



On pressing the CLEAR key the configuration set is sent to the zone

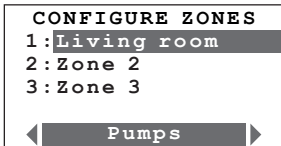
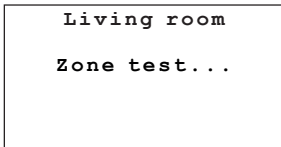

When the zone is configured press **CLEAR** twice to return to the Main Menu.

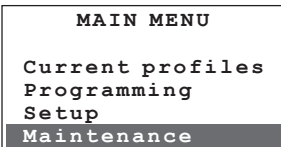

4 SWITCHING ON FOR THE FIRST TIME

4.5 Configuring the pumps

Can complete the zone configuration, indicating which pumps must control the zone and with how much delay.



This function can only be used if the probe is configured with the CEN configurator in socket P.

```

CONFIGURE ZONES
1: Living room
2: Zone 2
3: Zone 3
Pumps
    
```



Select the **zone**
(E.g.: Living room)



```

Living room
01: HEATING
02: -----
03: -----
Not connected
    
```



Confirm by pressing **OK**



One of the following options can be selected for each actuator in the list:

- ◀ Not connected ▶
- ◀ Heating ▶
- ◀ Cooling ▶
- ◀ Heat. & cool. ▶

Not present on the system or not managed by the zone selected
Is used to manage the Heating system
Is used to manage the Cooling system
Is used to manage both the Heating system and the Cooling system



Confirm by pressing **OK**

```

Living room
09: -----
HEAT 1
COOL 0
0
    
```



The last two items of the menu can select the delay in activating the pump



Selects the minutes of delay



to confirm

cont

4 SWITCHING ON FOR THE FIRST TIME

4.5 Configuring the pumps



```

Living room
Zone test...
    
```



```

CONFIGURE ZONES
1:Living room
2:Zone 2
3:Zone 3
Pumps
    
```



On pressing the CLEAR key the configuration set is sent to the zone

The control unit sends the configuration:

The following error message may be given

```

Living room
ERROR
Verify the probe
configuration
    
```

Make sure that the probe is in configuration (P = CEN) and try again; if it is not in this configuration, it cannot be configured via the control unit.

4 SWITCHING ON FOR THE FIRST TIME

4.6 Setting the Date and Time

Setting the Date/Time correctly is important for correct running of the set weekly programs.

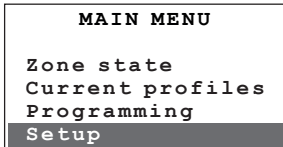

Select **Setup**



Confirm by pressing **OK**

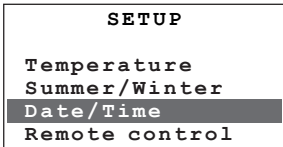

Select **Date/Time**



Confirm by pressing **OK**

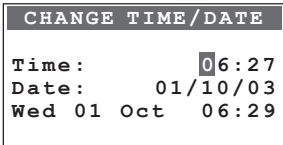

Type current Time and Date

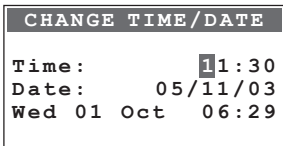

The keys move the selection by one digit



The keys change the Time/Date line and vice versa



Confirm by pressing **OK**

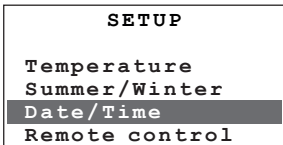

4 SWITCHING ON FOR THE FIRST TIME

4.7 Setting the Summer/Winter system

Sets the mode of operation of the Cooling or Heating system.



Before performing the switching, perform all the operations necessary for the hydraulic system to work correctly.

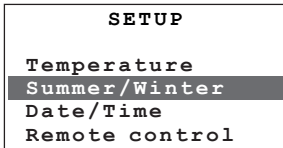

Select **Summer / Winter**

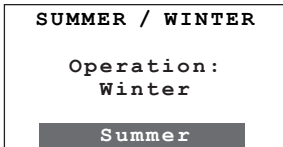

Confirm by pressing **OK**

*the display indicates the current state: **Winter***

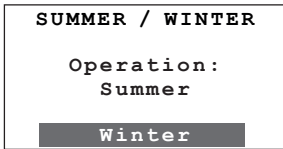

Confirm by pressing **OK**

*a **BEEP** signals that the modification has been made*

*the display indicates the new setting: **Summer***



After the switching the system is set on Antifreeze/Heat Protection mode.

5 MAIN MENU

Access to the Main Menu

After performing the operations described in the “Switching on for the first time” chapter, you can access the programming menus to perform a wide series of customisations which can exploit the features of the Temperature control unit to the full and satisfy user requirements.

There are two programming levels:

- **level 1** (user), gives access to all the menus **apart** from the **Maintenance** menu, where there are functions which are reserved to the installer or an expert user. Access to the user level can be protected by the **User code** (default disabled).
- **level 2** (installer), gives access to all the menus. Access to the installer level requires the **Maintenance code** (default 12345).



When the access codes are modified, they should be given in the boxes below.

User code
00000

NEW USER CODE

Mainten. code
12345

NEW MAINTENANCE CODE

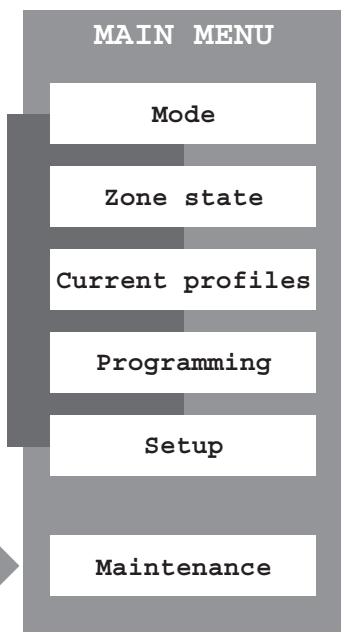

To quit the Main Menu wait for 2 minutes without pressing any key or press the

CLEAR

5 MAIN MENU

Main Menu tree

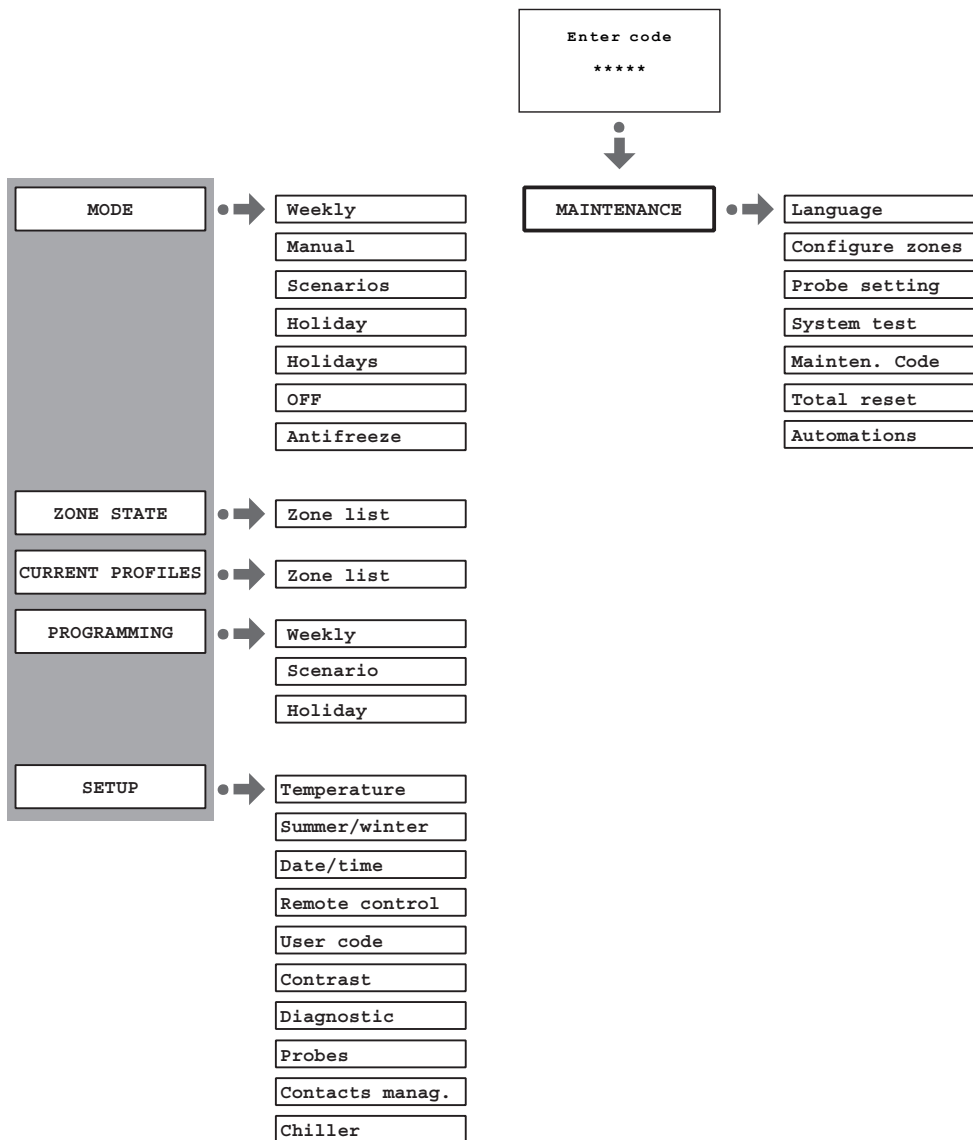

To quit the Main Menu wait for 2 minutes without pressing any key or press the



5 MAIN MENU



5.1 Mode

This mode can select the mode of operation in every zone of the system; the active modes are identified by the highlighted identification code.

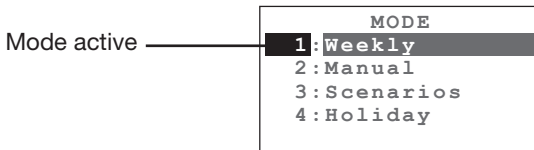

To access the MODE menu:

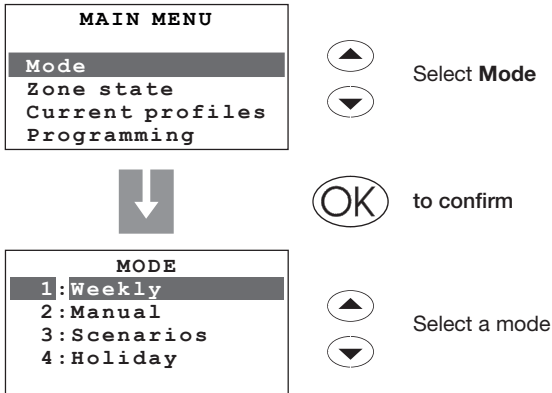

Modes of operation:

- 1 : Weekly** - 3 Winter programs, 3 Summer programs
- 2 : Manual** - fixed temperature on the whole system or the individual zone
- 3 : Scenarios** - 16 Winter scenarios and 16 Summer scenarios
- 4 : Holiday** - "Holiday" program for each zone
- 5 : Holidays** - system in antifreeze or heat protection until the date and time set
- 6 : OFF** - one or more zones in OFF
- 7 : Antifreeze** - one or more zones in Antifreeze or Heat protection

5 MAIN MENU

Mode

Zone state

Current profiles

Programming

Setup

Maintenance

5.1.1 Weekly

Can set a weekly program selected from those programmed.

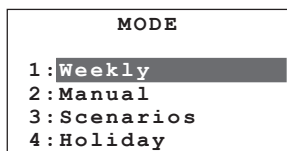

Select **Weekly**



to confirm

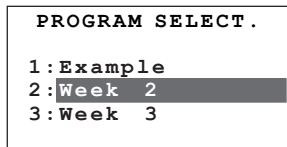

Select the weekly program
(e.g.: Week 2)



to confirm



*the initial page is displayed indicating
the program set*

5 MAIN MENU



5.1.2 Manual

Can set a fixed temperature on the whole system or on the individual zone.

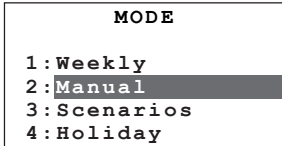

Select **Manual**



to confirm

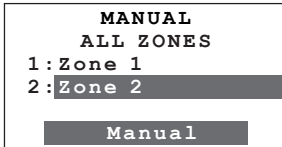

Select **ALL THE ZONES** or the Zone required (e.g.: Zone 2)



to confirm

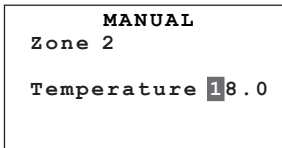

Type the temperature required using the number keys or using the keys to increase the temperature displayed by $\pm 0.5^{\circ}\text{C}$.



to confirm

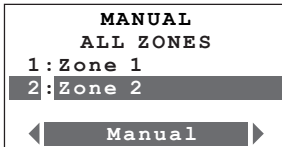

To place a zone set in Manual mode (number highlighted), in the normal mode of operation (general system mode) select it using the keys:



Premere **OK** to confirm



to return to the previous page, keep pressed to return to the first page



SOME ZONES

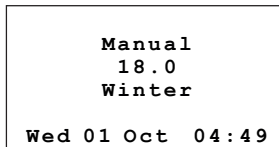

ALL THE ZONES

depending on the selection made the first page is displayed

5 MAIN MENU



5.1.3 Scenarios

Can activate a previously programmed scenario.

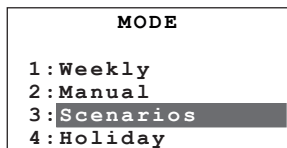

Select **Scenarios**



to confirm

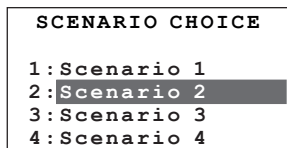

Select the Scenario required
(E.g.: Scenario 2)



to confirm

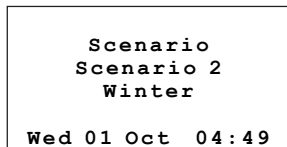

displays the first page indicating the scenario set

5 MAIN MENU



5.1.4 Holiday

The Holiday mode can select a particular daily profile for a set period. The program is run until the programmed date and time, after which the weekly program chosen will be reset.

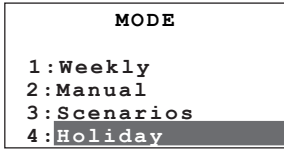

Select **Holiday**



to confirm

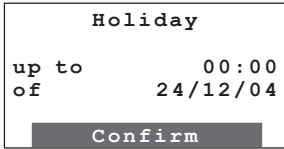

Type date and time using the number keys



to confirm

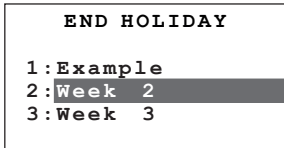

Select the weekly program to be reset at the end of the Holiday



(e.g.: Week 2)



to confirm

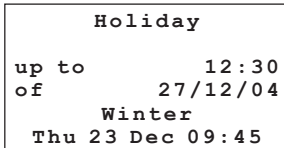

displays the first page indicating the program set

5 MAIN MENU



5.1.5 Holidays

This mode keeps the system in Antifreeze or Heat protection until the set date and time, after which the weekly program chosen will be reset.

- antifreeze 7°C (for the heating function)
- heat protection 35°C (for the air conditioning function).

```

MODE
2:Manual
3:Scenarios
4:Holiday
5:Holidays
    
```



Select **Holidays**



to confirm

```

Holidays
up to      00:00
of         24/12/04
Confirm
    
```

① ② ③
④ ⑤ ⑥
⑦ ⑧ ⑨
* 0 #

Type date and time
using the number keys



to confirm

```

END HOLIDAYS
1:Example
2:Week 2
3:Week 3
    
```



Select the weekly program to be reset
at the end of the Holidays program
(E.g.: Week 2)



```

Holidays
up to      08:30
of         07/01/05
Winter
Thu 23 Dec 08:30
    
```

*displays the first page indicating
the program set*

5 MAIN MENU



5.1.6 OFF

Can put all or some of the system zones in the OFF state, until one of the other modes is reset.

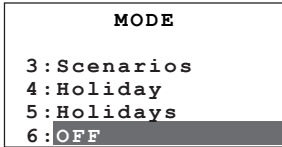

Select **OFF**



to confirm

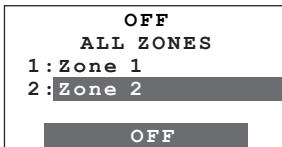

Select **ALL THE ZONES** or the Zone required (E.g.: Zone 2)



to confirm

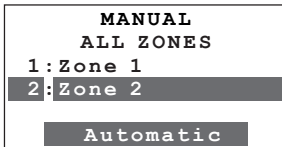

to return to the previous page, keep pressed to return to the first page

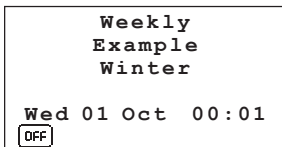

the initial page is displayed. The presence of the icon indicates that the mode is only active in some Zones

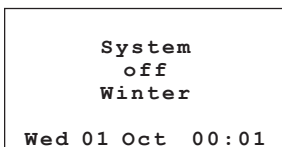

if the mode is active on ALL THE ZONES the first page displays "System off"

5 MAIN MENU



5.1.7 Antifreeze / Heat protection

Can set the antifreeze or heat protection temperature in some or all of the system zones as a function of the type of operation active.

MODE

4: Holiday
 5: Holidays
 6: OFF
 7: Antifreeze



Select **Antifreeze/Heat protection**



to confirm

ANTIFREEZE
ALL ZONES

1: Zone 1
 2: Zone 2

Antifreeze



Select **ALL THE ZONES** or the Zone required (E.g.: Zone 1)



to confirm

ANTIFREEZE
ALL ZONES

1: Zone 1
 2: Zone 2

Automatic

To put a zone set in Antifreeze mode (number highlighted) in the normal mode of operation (general system mode), press **OK**



to return to the previous page, keep pressed to return to the first page

Weekly
 Example
 Winter

Wed 01 Oct 00:01



the initial page is displayed. The presence of the icon indicates that the mode is only active in some Zones



Antifreeze
 system
 Winter

Wed 01 Oct 00:01

if the mode is active on ALL THE ZONES the first page displays "Antifreeze system"

5 MAIN MENU



5.2 Zone state

Gives the temperature measured, the temperature set and the system state for each zone.

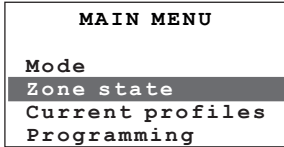

Select **Zone state**



to confirm

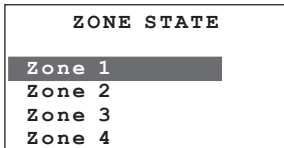

Select the Zone required
(E.g.: Zone 1)



to confirm

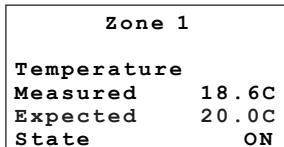
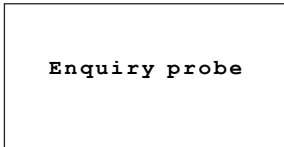

The display shows the following information:

- temperature measured in the zone

- temperature set in the zone

- system state in the zone:

ON = system ON

OFF = system OFF

If the system has a FAN-COIL the fan speed is given as well.



use the keys to select the other zones



(E.g.: Zone 2)

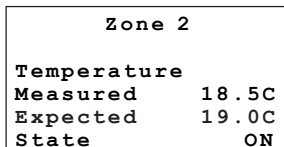

Press **CLEAR** for 2 seconds to return to the first page

5 MAIN MENU



5.3 Current profiles

Checks the mode of operation and the profile set for each zone.

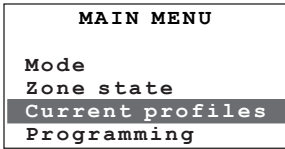

Select **Current profiles**



to confirm

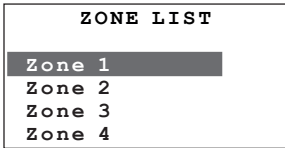

Select the Zone required
(E.g.: Zone 1)



to confirm

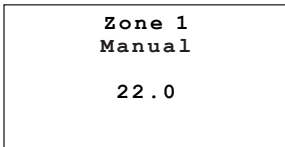

use the keys to select the other zones
(E.g.: Zone 2)

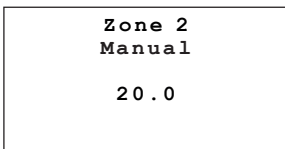

If the zone selected is in Weekly mode, the display of the heat profile set is displayed

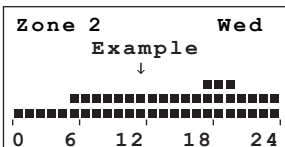

Press **CLEAR** for 2 seconds to return to the first page

5 MAIN MENU



5.4 Programming

This menu programs the profiles for the system modes of operation.

To access the PROGRAMMING menu:

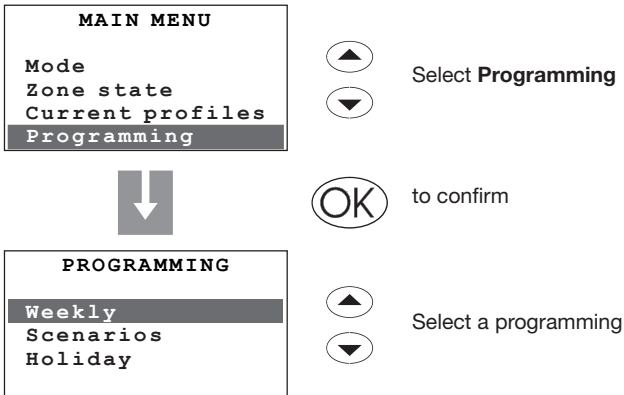

Programmings present:

Weekly - 3 Winter programs, 2 Summer programs

Scenarios - 16 Winter scenarios and 16 Summer scenarios

Holiday - “Holiday” program for each zone

5 MAIN MENU



5.4.1 Weekly

Can create up to 3 weekly programs for each of the system modes of operation (heating and cooling). Different daily temperature profiles (0h – 24h) can be defined for each day and each zone.

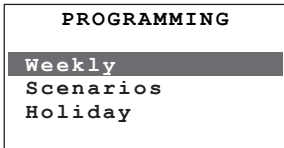

Select **Weekly**



to confirm

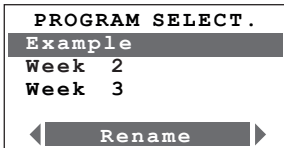

The following functions are available for the program selected:



Can rename the weekly program



Can modify the weekly program



Can copy a weekly program

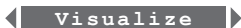

Can display the daily profiles associated with each zone



Can erase a weekly program

Use the keys to select the function required

Note: the “Example” program is preset but can be modified

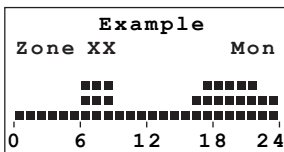

Monday ÷ Friday

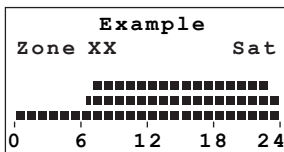

Saturday

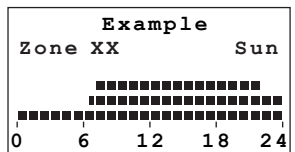

Sunday

5 MAIN MENU



5.4.1.1 Rename

This function can rename the weekly program selected (max 13 characters).

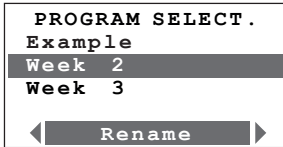

Select the program to be renamed



(E.g.: Week 2)



to confirm

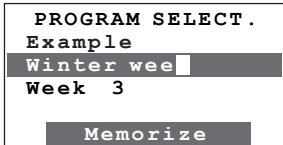

Type the name to be assigned to the program

(E.g.: Winter week)



to confirm

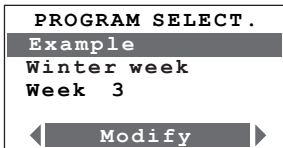

CLEAR to return to the previous page,
keep pressed to return to the first page

5 MAIN MENU



5.4.1.2 Modify

This function can modify the weekly program selected, associating a daily profile to each zone.

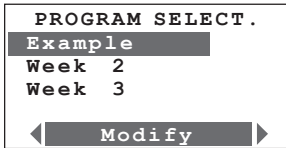

Select the program to be modified
(E.g.: Example)



to confirm

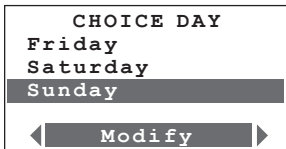

Select the day of the week
(E.g.: Sunday)



The **Copy from** (day) function is also available for the day selected.



to confirm

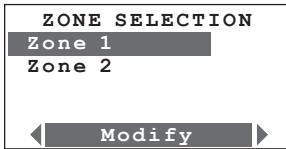

Select the zone (E.g.: Zone 1)



The **Copy from** (zone) **Visualize** functions are also available for the zone selected.



to confirm

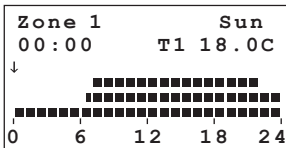

The profile displayed can be modified using the cursor keys



For more information see the example on the next page

5 MAIN MENU



Modifying a daily profile

The following information is shown on the display:

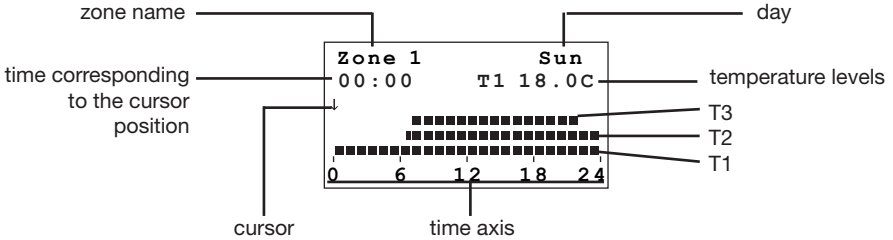

There are two modes of work:

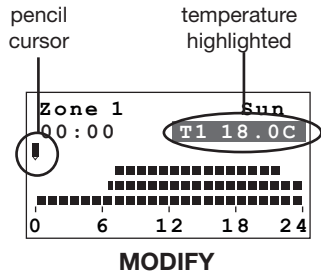
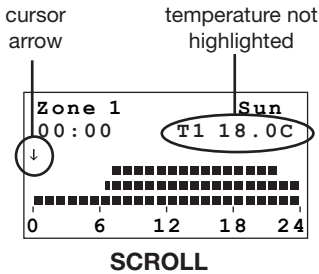

How to use the cursor keys:



- move the cursor along the time axis



- change from SCROLL mode to MODIFY
- in the MODIFY mode scroll the three temperature levels



OK - change from MODIFY mode to SCROLL
- in SCROLL mode confirms quitting **Modify**

CLEAR - returns to the previous page without saving

5 MAIN MENU



Example:

writing the following daily temperature profile (Monday):

- from 00:00 to 06:00 - 18°C (T1)
- from 06:00 to 09:00 - 22°C (T3)
- from 09:00 to 16:30 - 20°C (T2)
- from 16:30 to 22:00 - 22°C (T3)
- from 22:00 to 24:00 - 20°C (T2)

Temperature levels set
 T1= 18°C - T2= 20°C - T3= 22°C

Procedure:

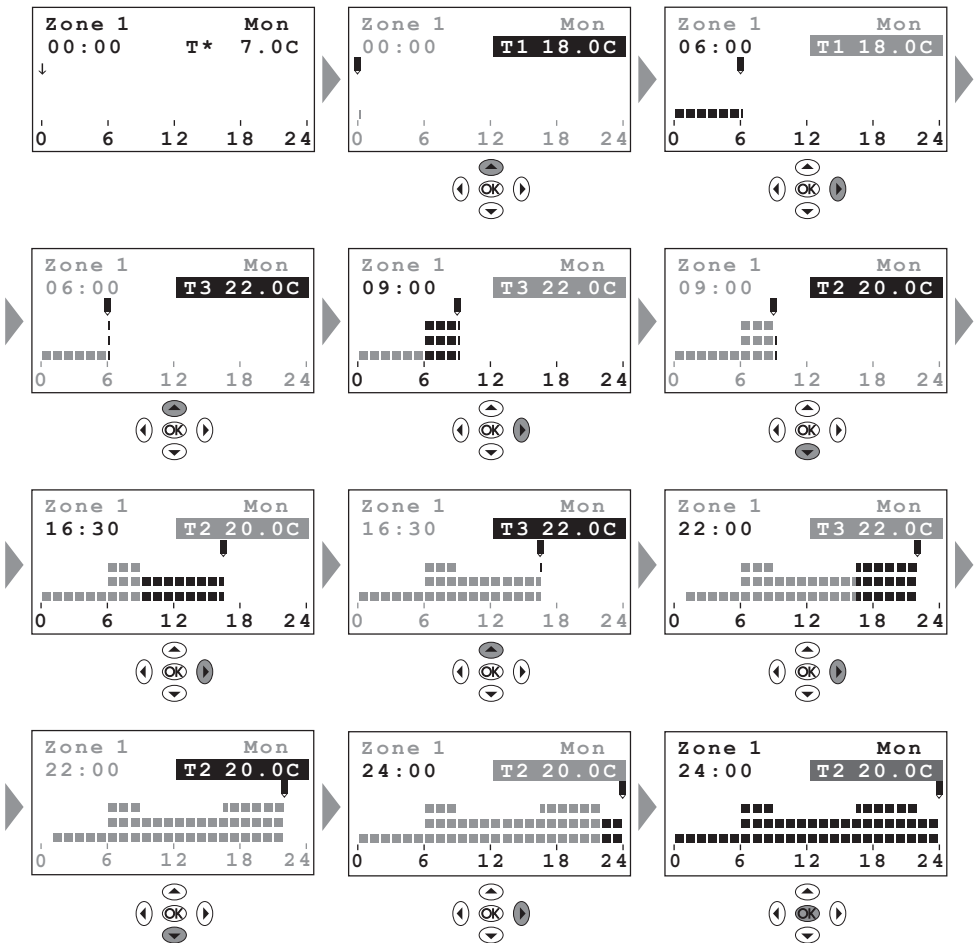

5 MAIN MENU

Mode

Zone state

Current profiles

Programming

Setup

Maintenance

Copy from (day)

Selecting the “Copy from” function a daily profile can be copied.

CHOICE DAY

Monday

Tuesday

Wednesday

Modify



Select **Copy from**



CHOICE DAY

Monday

Tuesday

Wednesday

Copy from



Select the day to be modified
(E.g.: Tuesday)



to confirm

COPY FROM

Monday

Tuesday

Wednesday

Thursday



Select the day to copy
(E.g.: Monday)



to confirm

Example

Copy
from: Monday
to: Tuesday



CHOICE DAY

Monday

Tuesday

Wednesday

Copy from

5 MAIN MENU



Copy from (zone)

Selecting the “Copy from” function the daily profile of a zone can be copied.

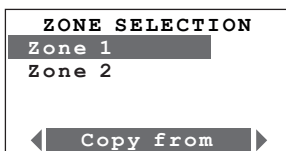

Select the zone to be copied into



to confirm

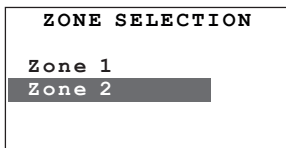

Select the zone to copy



to confirm

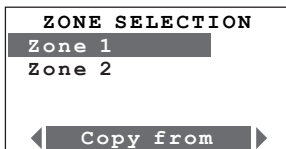

5 MAIN MENU



5.4.1.3 Copy from (weekly program)

This function can copy a weekly program.

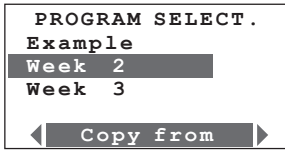

Select the program to be copied into



to confirm

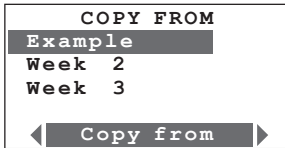

Select the program to copy



to confirm

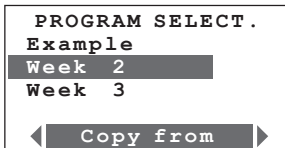
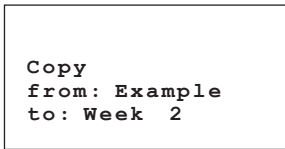

CLEAR to return to the previous page,
keep pressed to return to the first page

5 MAIN MENU



5.4.1.4 Display

This function can display the daily profiles associated with each zone.

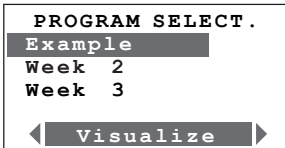

Select the weekly program (E.g.: Example)



to confirm

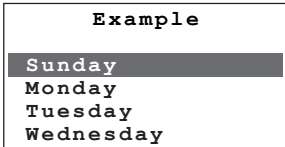

Select the day of the week (E.g.: Sunday)



to confirm

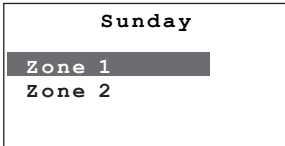

Select the zone (E.g.: Zone 1)



to confirm

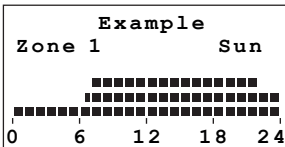

CLEAR to return to the previous page, keep pressed to return to the first page

5 MAIN MENU



5.4.1.5 Erase

This function can erase a weekly program resetting the default name, the profiles of all the zones and putting the program into antifreeze or heat protection.

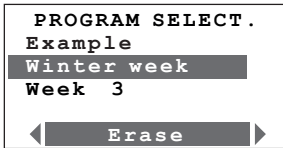

Select the program to be erased (E.g.: Winter week)



to confirm

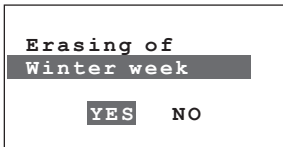

Select **YES**



to confirm

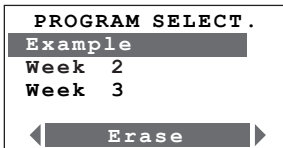

CLEAR to return to the previous page, keep pressed to return to the first page

5 MAIN MENU



5.4.2 Scenarios

Can create 16 scenarios for the Winter working and 16 for the Summer working and for each of them set different temperatures in the various zones.

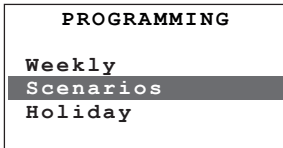

Select **Scenarios**



to confirm

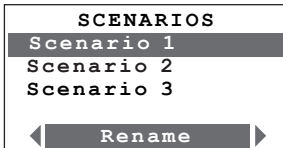

The following functions are available for the program selected:



Can rename the scenarios



Can modify the scenarios



Can copy the scenarios

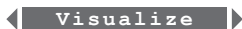

Can display the temperature levels set



Can erase a scenario

Use the   keys to select the function required.

5 MAIN MENU



5.4.2.1 Rename

This function can rename the selected scenario (max 13 characters).

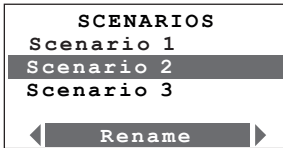

Select the scenario to be renamed
(E.g.: Scenario 2)



to confirm

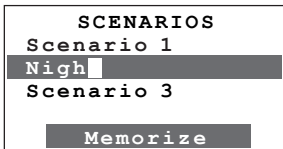

Type the name to be assigned to the scenario
(E.g.: Night)



to confirm

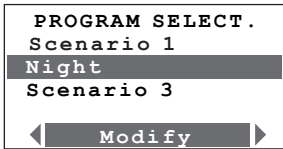

CLEAR to return to the previous page,
keep pressed to return to the first page

5 MAIN MENU



5.4.2.2 Modify

This function can modify the selected scenario associating a temperature level to each zone.

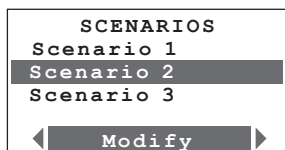

Select the scenario to be modified
(E.g.: Scenario 2)



to confirm

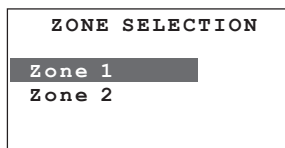

Select the zone
(E.g.: Zone 1)



to confirm

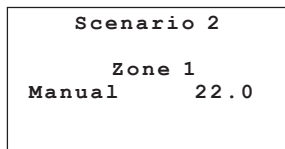

Set the temperature using the number keys or the
▲ ▼ keys ($\pm 0.5^{\circ}\text{C}$ increment)



to confirm

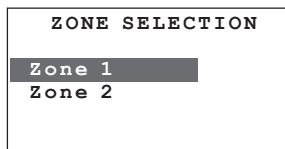

CLEAR to return to the previous page,
keep pressed to return to the first page

5 MAIN MENU



5.4.2.3 Copy from

This function can copy a scenario (temperature level set for each zone).

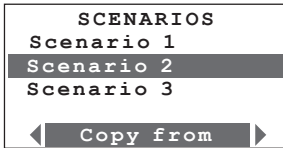

Select the scenario to be copied into
(E.g.: Scenario 2)



to confirm

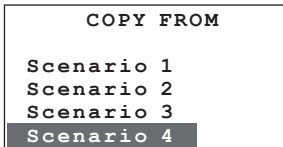

Select the scenario to copy
(E.g.: Scenario 4)



to confirm

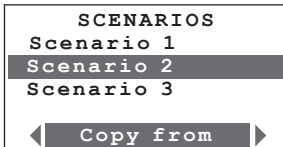

CLEAR to return to the previous page,
keep pressed to return to the first page

5 MAIN MENU



5.4.2.4 Display

This function can display the temperature level set for each zone.

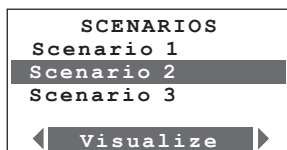

Select the scenario to display



(E.g.: Scenario 2)



to confirm

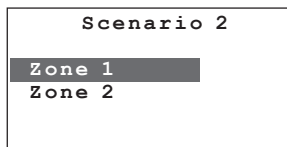

Select the zone



(E.g.: Zone 1)



to confirm

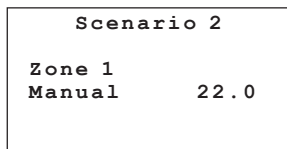

CLEAR to return to the previous page,
keep pressed to return to the first page

5 MAIN MENU



5.4.2.5 Erase

This function can erase the selected scenario and reset the name and default temperatures (20°C for winter, 23°C for summer).

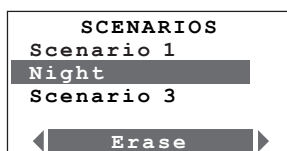

Select the scenario to be erased
(E.g.: Night)



to confirm

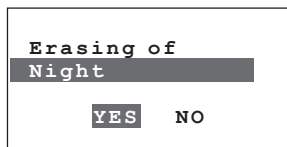

Select **YES**



to confirm

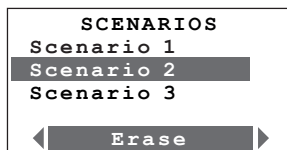

CLEAR to return to the previous page,
keep pressed to return to the first page

5 MAIN MENU



5.4.3 Holiday

Can program a daily profile for each zone (as base the profile of the Sunday of the Example program is associated with each zone).

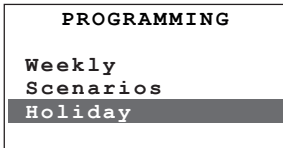

Select **Holiday**



to confirm

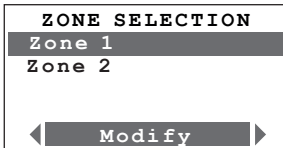

The following functions are available for the zone selected:



Can modify the daily profile of the individual zones



Can copy the profile from another zone

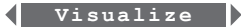

Can display the daily profile associated with the zone

Use the   keys to select the function required.

5 MAIN MENU



5.4.3.1 Modify

This function can modify the daily profile associated with a zone.

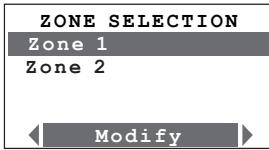

Select the zone to be modified (E.g.: Zone 1)



to confirm

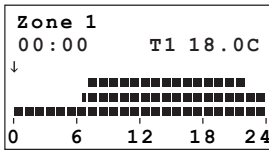

Modify the daily profile

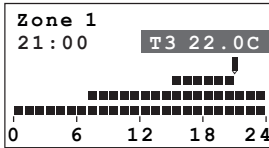

to confirm

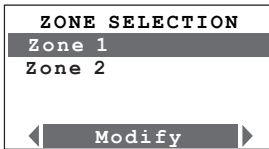

CLEAR to return to the previous page, keep pressed to return to the first page

5 MAIN MENU



5.4.3.2 Copy from

Can copy the daily profile from an already programmed zone.

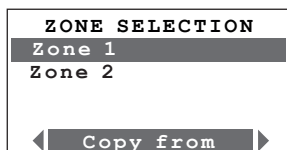

Select the zone to be copied into
(E.g.: Zone 1)



to confirm

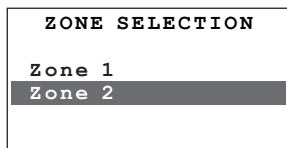

Select the zone to copy
(E.g.: Zone 2)



to confirm

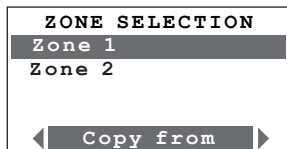

CLEAR to return to the previous page,
keep pressed to return to the first page

5 MAIN MENU

Mode

Zone state

Current profiles

Programming

Setup

Maintenance

5.4.3.3 Display

This function can display the daily profile associated with each zone.

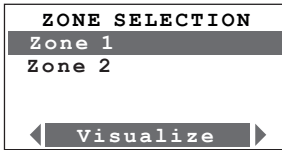

Select the zone to display
(E.g.: Zone 1)



to confirm

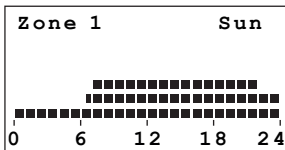

CLEAR to return to the previous page,
keep pressed to return to the first page

5 MAIN MENU



5.5 Settings

This menu can modify the available settings.

To access the SETUP menu:

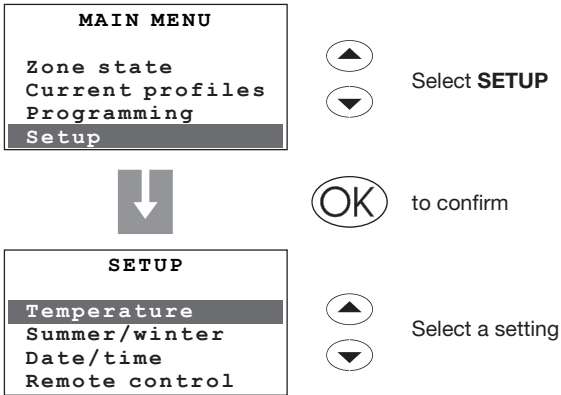

Settings present:

- **Temperatures** - temperature levels T1, T2, T3 and Antifreeze/Heat protection
- **Summer / Winter** - system mode of operation
- **Date / Time** - current date and time
- **Remote control** - enable/disable remote control
- **User code** - enable/disable and modify
- **Contrast** - modify display contrast
- **Diagnostics** - questioning and state of the system devices
- **Sensors** - query of the temperature sensors and threshold adjustment
- **Contacts management** - enables/disables the auxiliary contacts
- **Chiller** - query and status of the Climaveneta Chillers situated in the system

5 MAIN MENU



5.5.1 Temperatures

Can set the temperature levels T1, T2, T3 and Antifreeze/Heat protection (as base the same for all the zones) for each zone.

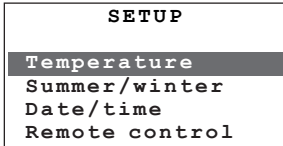

Select **Temperature**



to confirm

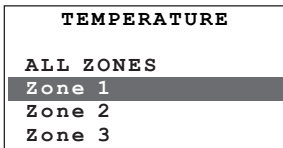

Select ALL THE ZONES or the Zone required



(E.g.: Zone 1)



to confirm

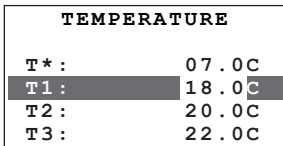

Select the temperature level to modify



(E.g.: T1)



to confirm

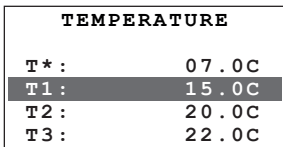

Type the temperature required using the number

keys or using the keys to alter the

temperature displayed by $\pm 0.5^{\circ}\text{C}$



to confirm

CLEAR to return to the previous page,

keep pressed to return to the first page



The temperature values can be set from 3 to 40°C. To guarantee correct working of the system the control unit automatically makes sure that T3 is higher than T2 and T2 higher than T1.

5 MAIN MENU



5.5.2 Summer/Winter

Sets the mode of operation of the Cooling or Heating system.

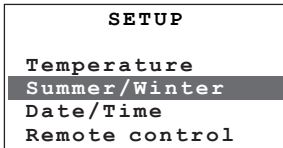

Select **Summer / Winter**



to confirm

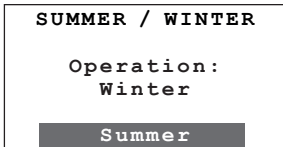

*the display indicates the current state: **Winter***



to confirm

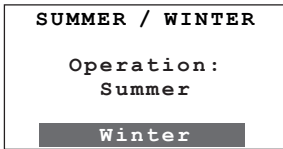

*a **BEEP** signals that the modification has been made*

*the display indicates the new setting: **Summer***



After the switching the system is set on Antifreeze/Heat Protection mode.



Before performing the switching, perform all the operations necessary for correct working on the hydraulic system.

5 MAIN MENU



5.5.3 Date/Time

Sets the current date and time.

Setting the Date/Time correctly is important in running the weekly programs set correctly.

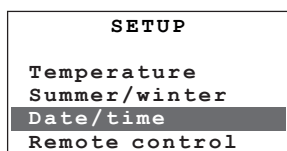

Select **Date / time**



to confirm

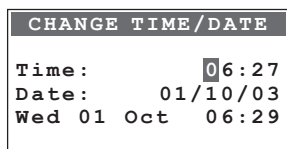

Type Time and Date

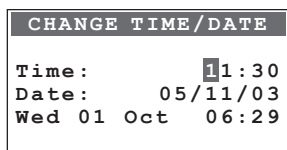

The keys move the selection by one digit



The keys change the Time/Date line and vice versa



to confirm

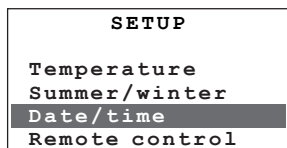

CLEAR to return to the previous page,
keep pressed to return to the first page

5 MAIN MENU



5.5.4 Remote control

Can enable/disable the remote control for remote management (user) and remote after-sales service (installer) using My Home portal. The remote management lets the user know and control the temperature of each zone remotely. The remote after-sales service lets the installer program the control unit and perform the system diagnostics remotely.

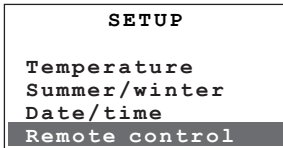

Select **Remote control**



to confirm

*the display indicates the current state: **enabled***



to confirm

*the display indicates the new setting: **disabled***



As factory setting the remote control is **enabled**.



To use the Touch Screen (item L/N/NT 4683) enable the remote control. If the remote control is disabled the control unit does not manage the "Remote" contact and does not perform any command received from the bus.

5 MAIN MENU



5.5.5 User code

Can enable/disable and customise the user code (as base **00000**).

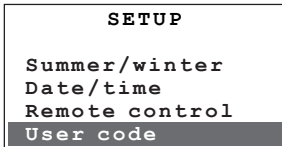

Select **User code**



to confirm



*the display indicates the current state: **disabled***



to confirm and change the state

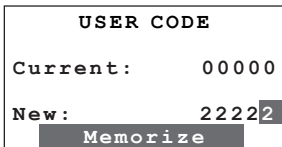

Type the **New** code (five digits) or confirm the **Current** code



to Save



*the display indicates the new setting: **disabled***

From now on you must type the user code set to access the Main menu.

The following functions are available:



Can disable the User Code



Can modify the User Code

Use the keys to select the function required



If a new user code is set, make a note of it in the space on page 63 of the User Manual.

5 MAIN MENU



5.5.6 Contrast

Sets the level of contrast of the graphic display.

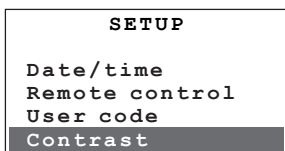

Select **Contrast**



to confirm

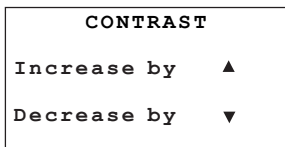

set the contrast level required



to confirm

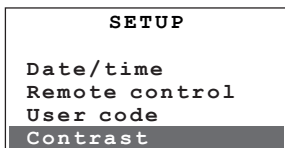

CLEAR to return to the previous page,
keep pressed to return to the first page

5 MAIN MENU



5.5.7 Diagnostics

If there is a fault in one or more of the system zones it can check the devices installed in the individual zones.

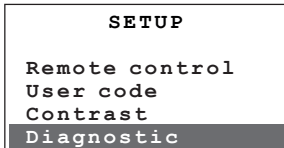

Select **Diagnostic**



to confirm

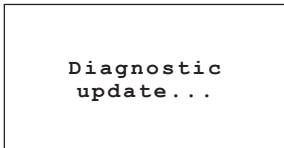

The control unit automatically updates the system diagnostic state

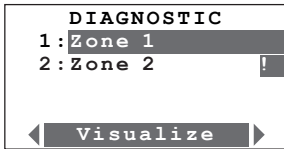

Select the **zone**



The following functions are available for the zone selected:



Can display the state of the zone selected



Can question the probe of the zone selected

Use the keys to select the function required.

If Climaveneta Chillers are detected during the diagnostic phase, "CHILLER DIAGN." will appear, thus making it possible to verify their status.



The "!" symbol identifies the zone where there are running problems.

5 MAIN MENU



5.5.7.1 Display

Displays the diagnostic information of the zone required in detail.

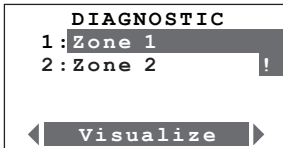

Select the zone
(E.g.: Zone 1)

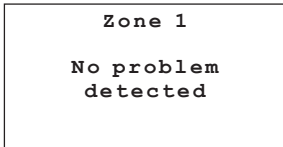

to confirm

The display indicates the zone state

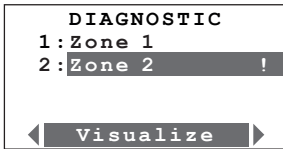

to return to the previous page



Select the zone
(E.g.: Zone 2)

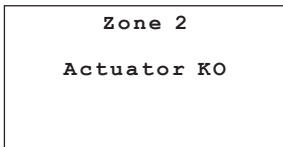

to confirm

The display indicates the zone state

CLEAR to return to the previous page,
keep pressed to return to the first page



To deal with any faults, consult the "Troubleshooting" section in this manual.

5 MAIN MENU



5.5.7.2 Update

Can question the probe to update the state of the zone selected.

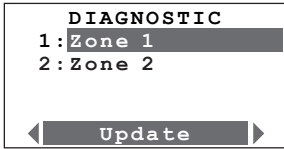

Select the zone
(E.g.: Zone 1)



to confirm

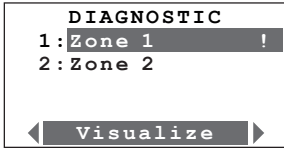
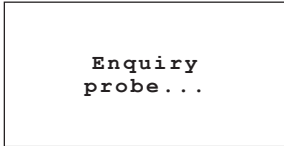

CLEAR to return to the previous page,
keep pressed to return to the first page

5 MAIN MENU



5.6 Sensors

Displays the list of the sensors configured through the TiThermo software and changes its set threshold value.

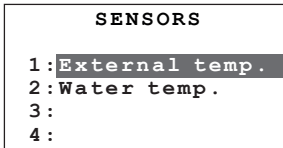

Select the sensors (E.g. External Temp.)



to confirm

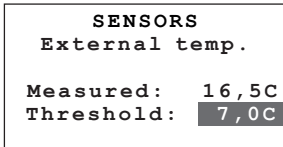

The display shows the temperature measured and, if required by the TiThermo programming, the set threshold value



to set the new value

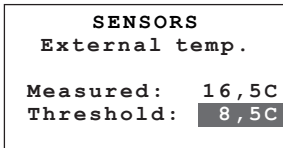

to confirm the setting



to return to the previous page; hold down to go back to the first page

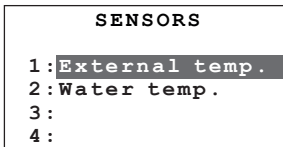

5 MAIN MENU

Mode

Zone state

Current profiles

Programming

Setup

Maintenance

5.7 Contacts management

Enables/disables the management of the auxiliary contacts (e.g. window contacts).

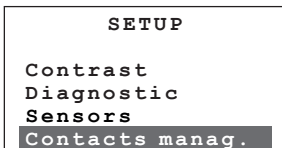

to change the current setup



to return to the previous page; hold down to go back to the first page

5 MAIN MENU



5.8 Chiller

This menu appears entirely if one or more Climaveneta Chillers have been detected in the system. Allows you to change the settings of the Chillers in the system.

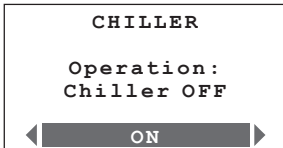

Select one of the following functioning modes

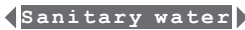

to confirm

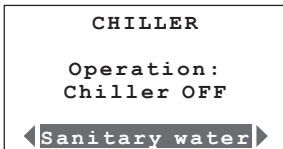

to return to the previous page; hold down to go back to the first page

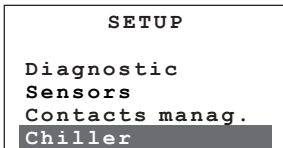

5 MAIN MENU



5.9 Maintenance

To prevent inexperienced users from modifying the settings and affecting the operation of the Temperature control unit, access to this menu is protected by the **Maintenance Code** (base **12345**).

To access the MAINTENANCE menu:

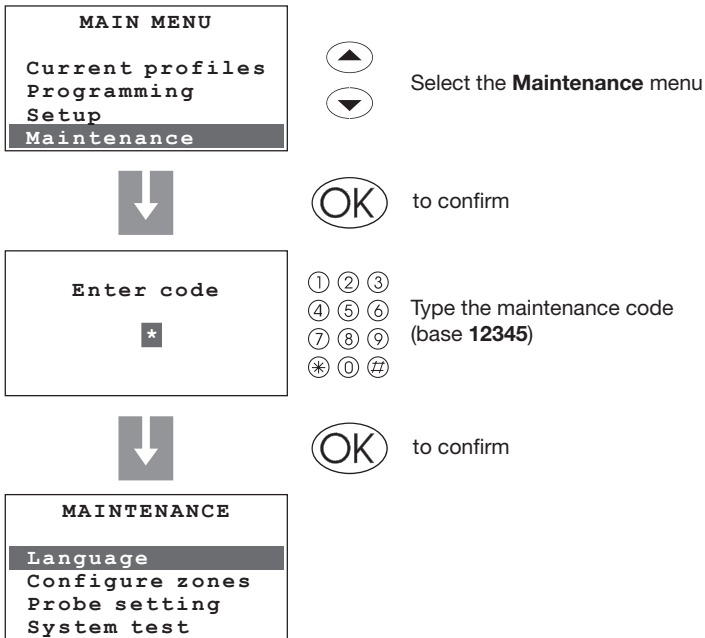

Items present:

- **Language** - Can select the language (base Italian)
- **Configure zones** - Can configure the system zones
- **Probe setting** - Can vary the temperature measured
- **System test** - Can perform maintenance or checks on the system
- **Maintenance code** - Can customise the maintenance code
- **Total reset** - Resets the control unit totally

5 MAIN MENU

Mode

Zone state

Current profiles

Programming

Setup

Maintenance

5.9.1 Language

Can select the language in which the messages are shown on the display.

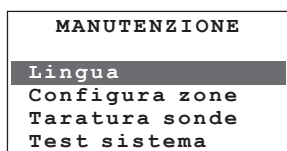

Select **Language**



to confirm

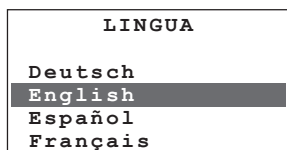
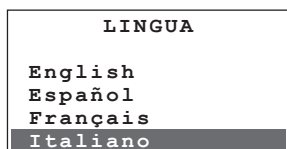

Select the language required
(e.g.: English)



to confirm

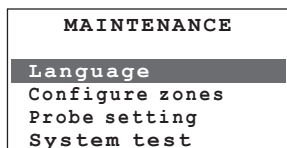

CLEAR to return to the previous page,
keep pressed to return to the first page

5 MAIN MENU



5.9.2 Configure zone

Can perform the system learning and manage the zone configuration.

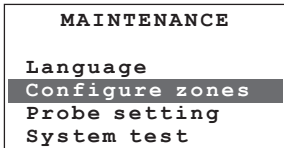

Select **Configure zones**



to confirm

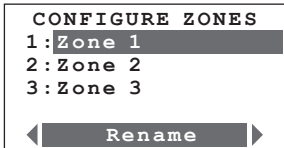

Select the zone



The following functions are available for the zone selected:

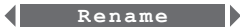

Can rename the zone selected



Can configure the actuators for the zone selected



Can configure the pumps for the zone selected



Can erase the zone selected



Can zero the configuration of all the zones

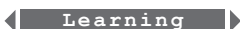

Searches all the zones in the system



Configures the zones on the basis of the settings received from the PC via the TITHERMO software.

Use the   keys to select the function required.

5 MAIN MENU



5.9.2.1 Rename

This function can customise the name of the zone selected (max 13 characters).

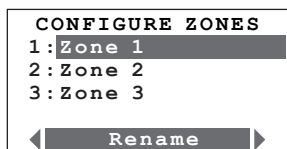

Select the **zone**



to confirm

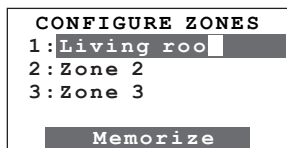

Type the zone name
 (E.g.: Living room)



to confirm

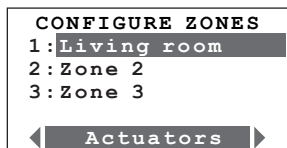

CLEAR to return to the previous page,
 keep pressed to return to the first page

5 MAIN MENU



5.9.2.2 Actuators

Can complete the configuration of the zones, indicating:

- which actuators are installed for Heating
- which actuators are installed for Cooling
- which type of load the zone manages.



This procedure must only be performed for the Standard configuration (see My Home Guide – “Probe configuration” section).

```

CONFIGURE ZONES
1: Living room
2: Zone 2
3: Zone 3
Actuators
    
```



Select the **zone**
(E.g.: Living room)



to confirm

```

Living room
01: HEATING
02: -----
03: -----
Not connected
    
```



*One of the following options
can be selected for each
actuator in the list:*

```

Not connected
    
```

Not in the system

```

Heating
    
```

Is used to manage the Heating system

```

Cooling
    
```

Is used to manage the Cooling system

```

Heat. & cool.
    
```

Is used to manage both the Heating system and the Cooling system (e.g.: 2 pipe fan-coil)



to confirm

```

Living room
09: -----
HEAT ON/OFF
COOL OPEN/CLOSE
FAN-COIL 3V
    
```



*The last two items of the
menu can select the type
of load managed*



cont

5 MAIN MENU



```

Living room
09: -----
HEAT ON/OFF
COOL OPEN/CLOSE
FAN-COIL 3V
    
```



One of the following options can be selected for each actuator in the list:

ON/OFF

Load managed by just one contact (e.g.: thermostatic valve)

OPEN/CLOSE

Load managed by two interlocked relays (e.g. motor-driven valve with opening contact and closing contact)

FAN-COIL 3V

Fan-coil with control of one valve and selector switch up to 3 speeds

GATEWAY

Interface for Climaveneta Fan-coil



```

Living room
Zone test...
    
```



Press the CLEAR key to send the configuration set to the zone

The control unit tests the configuration. When this is finished there may be two error messages:

```

Living room
Configuration
invalid
    
```

Trying to set a configuration of actuators which is not allowed (example: actuators of different type for the same function) in a probe



```

CONFIGURE ZONES
1: Living room
2: Zone 2
3: Zone 3
Pumps
    
```

```

Living room

ERROR
Verify the
probe
configuration
    
```

Check that the probe is in standard configuration (MOD=CEN) and try again; if it is not this type of configuration, the control unit cannot configure the probe.

5 MAIN MENU

Mode

Zone state

Current profiles

Programming

Setup

Maintenance

5.9.2.3 Pumps

Can complete the configuration of the zones, indicating which pumps must control the zone and with how much delay.



This function can only be used if the probe is configured with the CEN configurator in socket P.

```

CONFIGURE ZONES
1: Living room
2: Zone 2
3: Zone 3
Pumps
    
```



Select the **zone**
(E.g.: Living room)



Confirm by pressing **OK**

```

Living room
01: HEATING
02: -----
03: -----
Not connected
    
```



*One of the following options
can be selected for each
actuator in the list:*

- ◀ Not connected ▶
- ◀ Heating ▶
- ◀ Cooling ▶
- ◀ Heat. & cool. ▶

Not in the system or not managed by the zone selected
Is used to manage the Heating system
Is used to manage the Cooling system
Is used to manage both the Heating system and
the Cooling system



Confirm by pressing **OK**

```

Living room
09: -----
HEAT 1
COOL 0
0
    
```



*The last two items of the menu
can select the delay with which
the pump is activated*



Select the minutes of delay



to confirm

cont

5 MAIN MENU

Mode

Zone state

Current profiles

Programming

Setup

Maintenance



Living room
Zone test...



CONFIGURE ZONES

1: Living room
2: Zone 2
3: Zone 3

◀ Pumps ▶

CLEAR

Press the CLEAR key to send the configuration set to the zone

The control unit tests the configuration.

The following error message may be given

Living room

ERROR
Verify the probe
configuration

Check that the probe is in configuration (P=CEN) and try again; if it is not this type of configuration, the control unit cannot configure the probe.

5 MAIN MENU



5.9.2.4 Erase

Can erase the zone selected from the configuration.

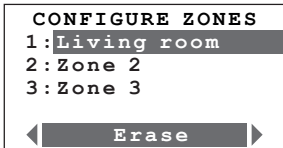

Select the **zone**



to confirm



Select **YES**



to confirm

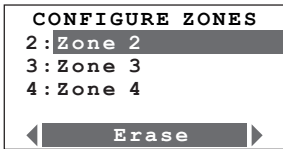

CLEAR to return to the previous page,
keep pressed to return to the first page



The Control Unit no longer manages the erased zones.

5 MAIN MENU

Mode

Zone state

Current profiles

Programming

Setup

Maintenance

5.9.2.5 Zero all

Can erase the saved configuration of all the zones.

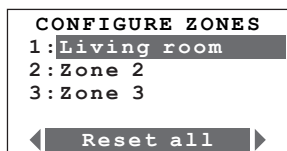

to confirm

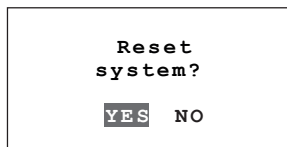

Select **YES**



to confirm

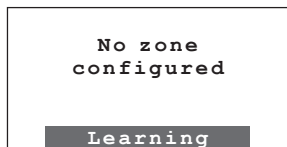

From this moment on the Control Unit no longer manages any zones. To reset the system operation, perform the zone **LEARNING.**

5 MAIN MENU

Mode

Zone state

Current profiles

Programming

Setup

Maintenance**5.9.2.6 Learning**

Searches all the zones in the system.

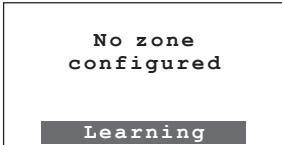

to confirm

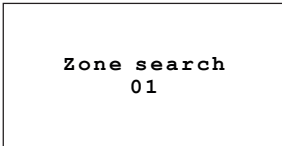

The system searches the zones from 1 to 99.
Depending on the system size, this operation
may take a few minutes.

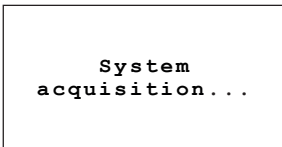
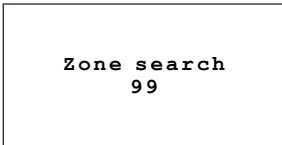

When the search has finished it returns
to the Configure zones menu

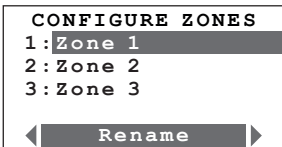

CLEAR to return to the previous page,
keep pressed to return to the first page

5 MAIN MENU

Mode

Zone state

Current profiles

Programming

Setup

Maintenance

5.9.2.7 Send

Sends the actuator and pump settings to all the configured zones.

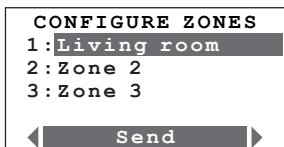

to confirm

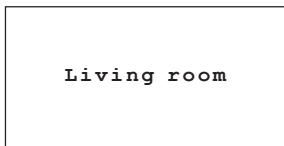

The control unit sends the configuration set to the zones in the system.



This message may be displayed during the send phase:

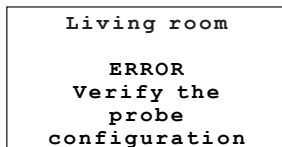
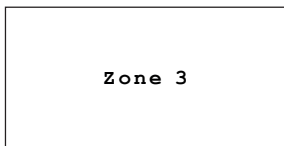

Pressing **CLEAR** cancels sending the configuration
Press **OK** to go to the next zone

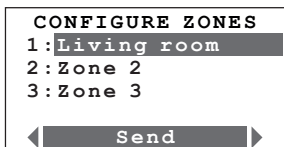

When the send is completed, it returns to the Configure zones menu

5 MAIN MENU



5.9.3 Probe setting

Can align the temperature measured by the probes to a value measured with other devices (thermometer,...) to guarantee better precision in system operation.

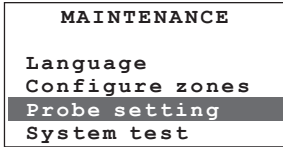

Select **Probe setting**

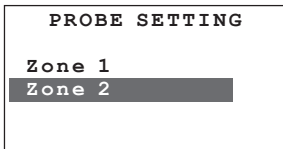

to confirm



Select the zone
(E.g.: Zone 2)

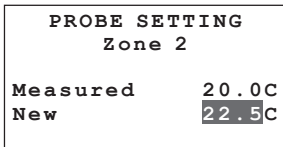

to confirm



Set the effective temperature measured in
the room ($\pm 0.1^{\circ}\text{C}$ increment).

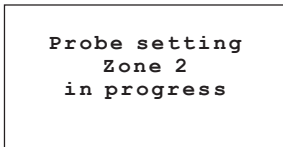

to confirm

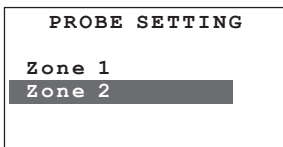

CLEAR to return to the previous page,
keep pressed to return to the first page

5 MAIN MENU



5.9.4 System test

Can put the system in **Test** (the whole system OFF) to check the system. It automatically disables all the commands (including the remote commands).

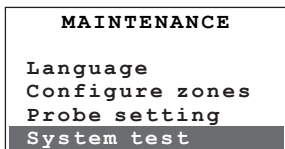

Select **System test**



to confirm

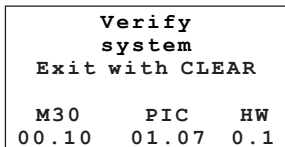

The display indicates the Control Unit software and hardware versions:

M30 – firmware version

PIC – firmware version SCS interface

HW – hardware version



to quit and return to the previous page

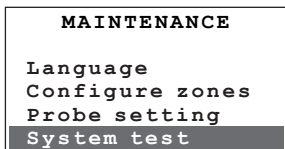

5 MAIN MENU



5.9.5 Maintenance code

Can set a new Maintenance Code.

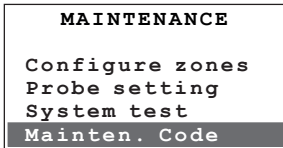

Select **Maintenance Code**



to confirm

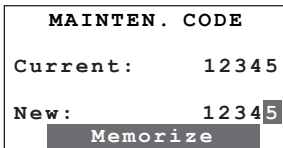

- ① ② ③
- ④ ⑤ ⑥
- ⑦ ⑧ ⑨
- * ⑩ #

Type the new maintenance code
(E.g.: 55555)

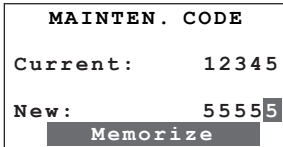

to confirm

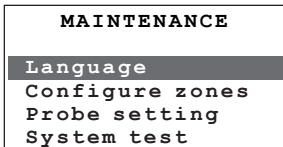

From now on you must type the new code set to access the Maintenance menu.



If a new MAINTENANCE CODE is set, make a note of it in the space on page 23 of this manual.

5 MAIN MENU



5.9.6 Total reset

Can perform a Control Unit total reset. All the settings will be lost and the factory settings will be reset (see page 10 of the manual).

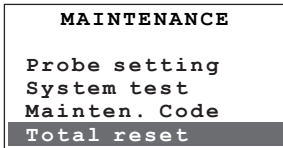

Select **Total reset**



to confirm

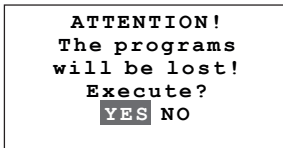

Select **YES**



to confirm



The Reset operation takes about 30 seconds.

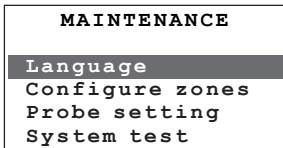

CLEAR to return to the previous page,
keep pressed to return to the first page



With this operation the system configuration and all the programs run will be lost!

5 MAIN MENU



5.9.7 Automations

By using the TiThermo software, it is possible to programme automations that will start operating when specific temperature conditions, detected by the gateway or sensors in the system, occur.

In this menu it is possible to enable or to disable the programmed automations.

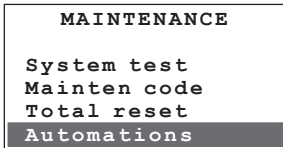

Select **Automations**

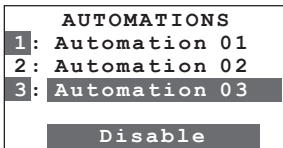

to confirm



Select the automation (the active automations are identified by the high-lighted number).

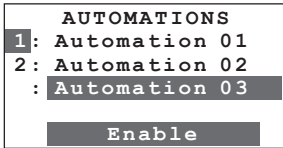

to disable the Automation

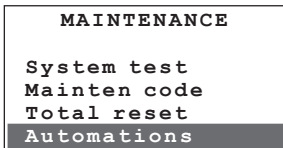

to go back to the previous screen; hold down to go back to the first page

APPENDIX

Technical data

Power supply	from SCS bus: from 18V to 28V
Absorption (Max)	75 mA
Working temperature	5 to 40°C
Dimensions	L= 140 H= 210 D= 35
Degree of protection	IP 30

Standards references

The item covered by the manual has the CE Declaration of Conformity according to the requirements indicated below:

BTicino S.p.A. with offices in Via Messina, 38 - 20154 Milano (Italy)

declares that the product item number: **3550**

respects the following standards: **EN60950 EN50090-2-2**

Year of approval CE marking according to the directive indicated: 2004

Customer Technical After-Sales Service

BTicino assumes responsibility for the perfect working of the device only if it is installed to the state of the art respecting the indications of the product's installation manual.

If it does not work properly contact the Authorised Technical After-Sales Service Centre.

For the name of your Service Centre visit the site:

www.bticino.com

Guarantee: the guarantee terms are given in the document "BTicino Technical After-Sales Service Supply Conditions".

This document can be obtained from the Service Centre or downloaded from the www.bticino.com site



TROUBLESHOOTING

PROBLEM	SOLVING
Battery flat signal	Check that the battery is correctly connected. If the problem continues, replace the battery.
A zone does not adjust correctly	Check whether any problems have been signalled (Settings>Diagnostic>Update).
A zone signals “Error on probe”	The probe does not respond; check whether it is correctly connected (green LED shining steadily or flashing slowly) and configured (correct zone number and mode).
A zone signals “Actuator KO”	An actuator does not respond: <ul style="list-style-type: none"> - check whether the actuators are correctly connected and configured (test the actuators with the local key); - with standard configuration, check that the configuration has been performed correctly in the control unit Maintenance>Configure zone>Configure).
A zone signals “Slave probe KO”	A slave probe does not respond: <ul style="list-style-type: none"> - check whether it is correctly connected (green LED shining steadily or flashing slowly) and configured (correct zone number, SLA mode); - check the correct configuration of the slaves to be managed on the Master probe.
A zone signals “T out of limits”	The temperature measured by the probe is too low or too high: <ul style="list-style-type: none"> - check that the probe is installed correctly (e.g. not too close to heat sources); - set the probe (Maintenance>Probe setting) measuring the room temperature with a thermometer; - if the problem continues, replace the probe.
A zone signals “R/W EEPROM KO”	If there is an internal problem on the probe, replace the probe.
A zone signals “Pump KO”	The actuator configured to control the circulation pump (Zone=00) does not respond: <ul style="list-style-type: none"> - check that the actuator is correctly connected and configured (test the actuator with the local key); - check the correct configuration of the pump management on the probe.



BTicino SpA
Via Messina, 38
20154 Milano - Italy
www.bticino.com

Servizio clienti



BTicino SpA si riserva il diritto di variare in qualsiasi momento i contenuti illustrati nel presente stampato e di comunicare, in qualsiasi forma e modalità, i cambiamenti apportati.
BTicino SpA reserves at any time the right to modify the contents of this booklet and to communicate, in any form and modality, the changes brought to the same.