

[Access to the full Light Up documentation](#)



CONTENTS	PAGE
1. Use	1
2. Technical characteristics	1
3. Loads	2
4. Dimensions	2
5. Presentation	2
6. Mounting	2
7. Wiring	3
8. Installation	4
9. Performance	5
10. Modes	5
11. Legrand Close Up app	5
12. Settings with Close Up	6
13. Surface-mounting accessory	8
14. Description of buttons and LEDs	9
15. Standards	10
16. Care	10
17. Troubleshooting	10

1. USE

This product is a DALI presence sensor.
 The presence sensor has a 360° detection angle.

It has:

- The option of being paired with a **wireless batteryless switch** and/or controlling a **connected power outlet**.
- **1 auxiliary input** for overriding lighting using the wired push-button.
- **1 presence sensor** (PIR technology) with lens for detecting occupancy.
- **1 daylight sensor** which measures natural and artificial light in order to control lighting according to the desired lighting setpoint.
- **1 DALI output** for supplying the bus and controlling lighting.

1.1 Bluetooth® 5.0

- For commissioning the product in a standalone system using the **Legrand Close Up** mobile app.
- Product updating.

1.2 Radio (2.4 - 2.483 GHz)

- Creation of a standalone system, can be used to pair 1 power outlet and 1 wireless batteryless switch.

2. TECHNICAL CHARACTERISTICS

2.1 Consumption

- Voltage: 110 - 230 V~
- Frequency: 50/60 Hz

2.2 Standby consumption

- OFF load → 0.85 W
- ON load → 0.85 W

2.3 Installation

- Installation in false ceiling
- Screw terminals: 2 x 1.5 mm² or 1 x 2.5 mm²
- Drilling diameter: 68 mm

2. TECHNICAL CHARACTERISTICS (continued)

2.4 Mechanical characteristics

- Impact resistance: IK04
- Penetration by solid and liquid matter: IP20
- Weight:
 - of product: 149.5 g
 - packaged: 193.6 g

2.5 Climate characteristics

- Usage temperature: -10°C to +30°C
- Storage temperature: -20°C to +70°C

2.6 Sensor

- Infrared
- Detection diameter: 12 m (for a height of 2.5 m from the floor)
- Minimum installation height: 1.7 m

2.7 Factory settings

- Light level: 300 lux
- Time delay: 15 minutes
- Auto ON/OFF mode with Walkthrough mode enabled

2.8 Bluetooth®



Can be used to set up the product with a smartphone.

- The LED indicates: LED off ○ → Not twinned
 Steady blue ● → Twinned

- Range: 10 m
- Compatible from 4.2 upwards

2.9 Radio

- Frequency: 2.4 GHz (16 channels)
- Output power: +8 dBm
- Data rate: 250 kbps
- Range: 10 m
- Security: Wireless mesh network, self-adaptive and secure (AES 128), conforming to standard IEEE 802.15.4 (LR-WPAN)

2.10 Declaration of compliance

- **f (Frequency):** 2.4 to 2.483 GHz
- **P (Power):** <100 mW

LEGRAND declares that the radio-electric equipment type Cat. No. **0 485 52** complies with directive 2014/53/EU. The full text of the EU declaration of conformity is available on the following website: www.legrand.com/ecatalogue

3. LOADS

3.1 DALI

Maximum number of ballasts (ECGs): 50

- Voltage: 16 V
- Guaranteed current: 100 mA
- Maximum current: 130 mA

4. DIMENSIONS

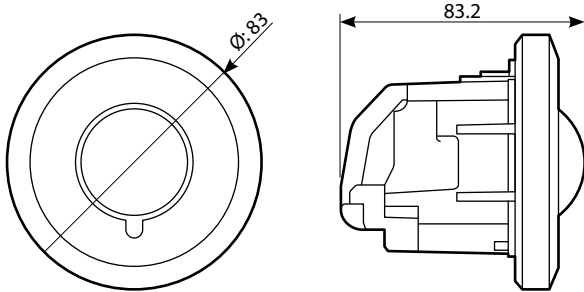

5. PRESENTATION

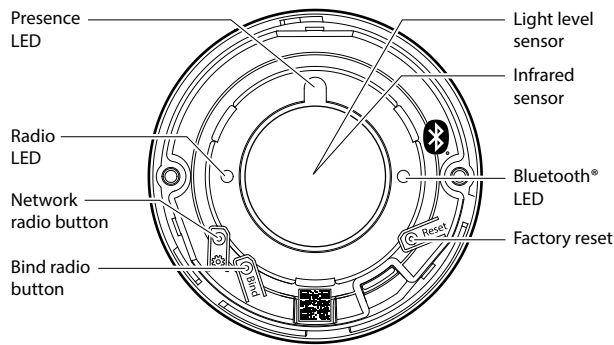

6. MOUNTING

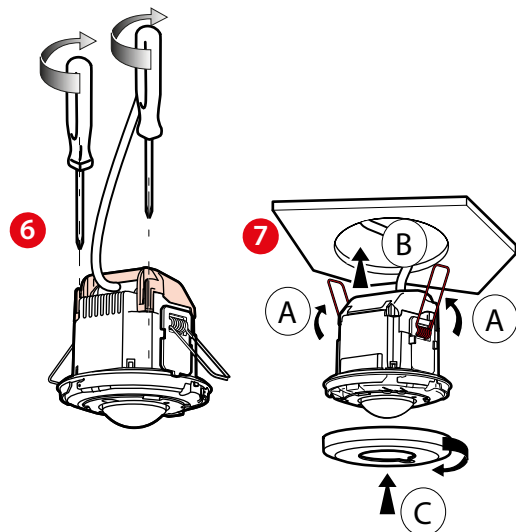
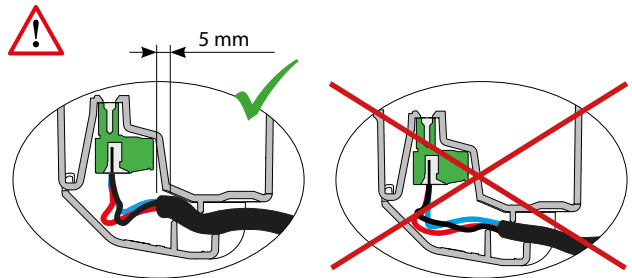
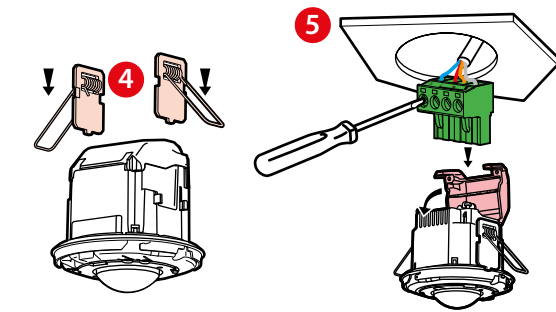
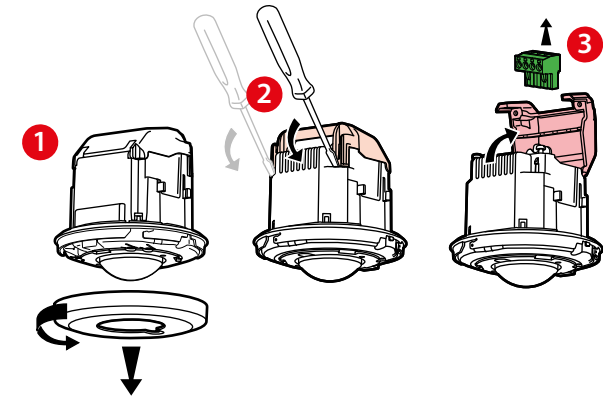
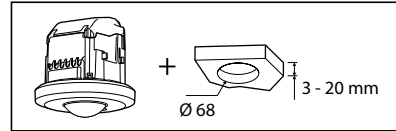

Mounting and wiring must be done with the power off. Please follow the Safety Instructions exactly.

7. WIRING

7.1 Standalone solution

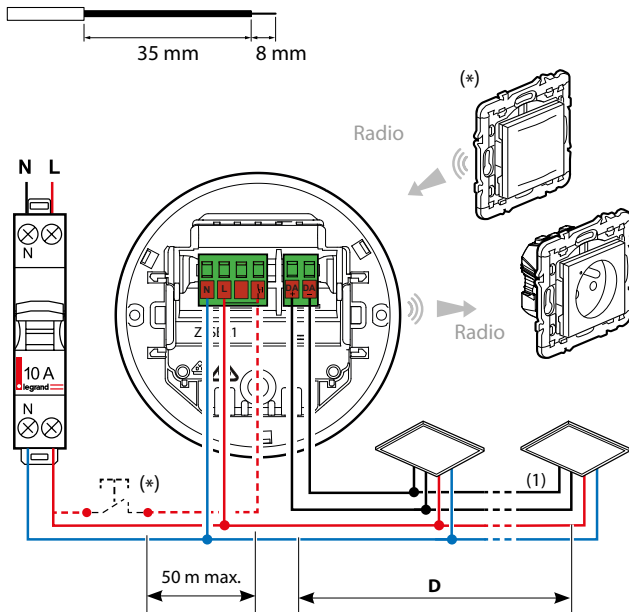

(*) This product can be controlled by:

- A wireless batteryless switch
 - Or
 - A wired push-button
- And it can control a connected power outlet (wirelessly).

Note:

The maximum distance between the wired push-button and the auxiliary input is 50 m.

Note:

To pair a control point and/or a power outlet in standalone mode, Please refer to the description of procedures in the **Light Up technical guide**.

(1) Recommended cable cross-section for the 1.5 mm² DALI output.

CAUTION:

The sensor provides the DALI BUS power supply. Do not connect 2 sensors to the same DALI BUS.

(*) Option of combining with a wireless batteryless lighting switch (maximum 2 per sensor)

Cat. Nos. 0 677 23L/73L/79L, 0 770 53L, 6 000 83L, 5 742 10/39/55, 5 743 24, 7 418 13L/43L/73L and a connected power outlet (maximum 5 per sensor)

Cat. Nos. 0 677 25A/75A, 0 648 95A, 0 777 11LA, 6 003 91A, 5 742 56/57/58/59, 7 419 11/41/71 as described in the Light Up Guide procedures

DALI BUS

D	
≤ 100 m	0.5 mm ²
≤ 150 m	0.75 mm ²
≤ 300 m	1.5 mm ²

7.2 Primary/Secondary

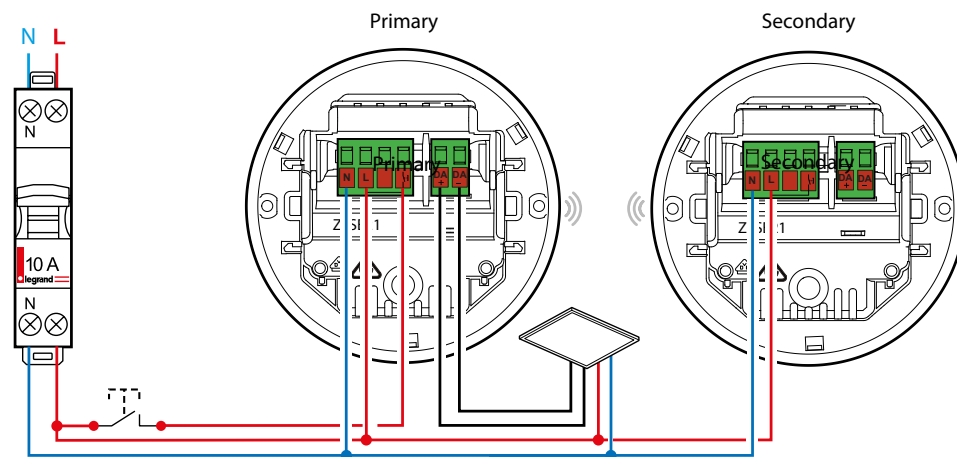

By default the product is configured as **Primary**. To change it to **Secondary**, refer to the description in the **Light Up technical guide**.

The primary can be paired with a maximum of 5 sensors configured as secondaries.

The secondary can extend the detection zone. No loads should be paired with it.

If being used in "Primary/Secondary" mode, the wired push-button should only be connected to the **primary** sensor.



Sensor 0 485 52 is configured to control dimmable DALI ECGs; it can be paired with DALI actuators (ON/OFF). To do this, use the "LEGRAND Close Up" app on your smartphone to change the type of load used, in this case "Non Dimmable"

8. INSTALLATION

8.1 Positioning the sensor

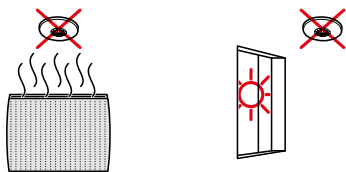
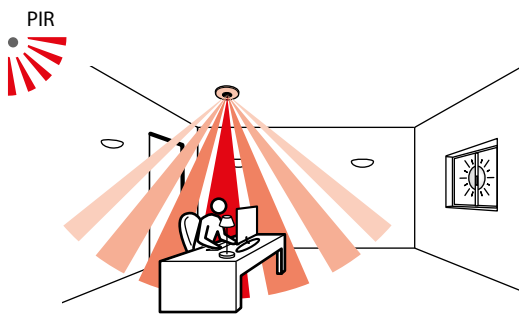

8. INSTALLATION (CONTINUED)

8.2 Recommended light exposure

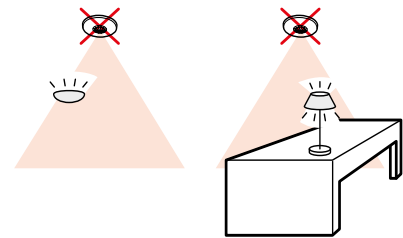
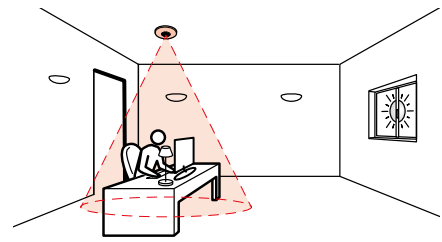

8.3 Accessory to limit the detection zone

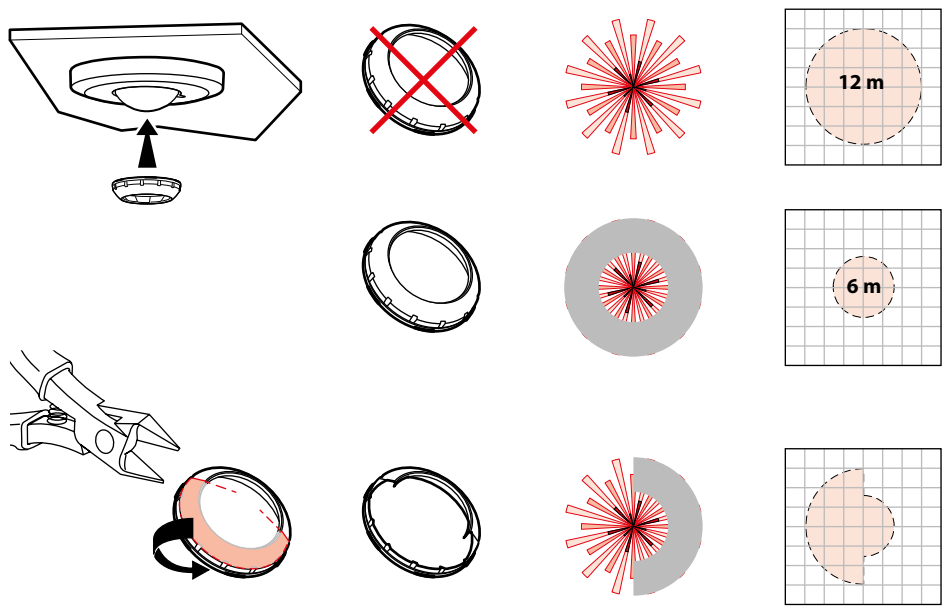

9. PERFORMANCE

9.1 Sensing model

Axial approach

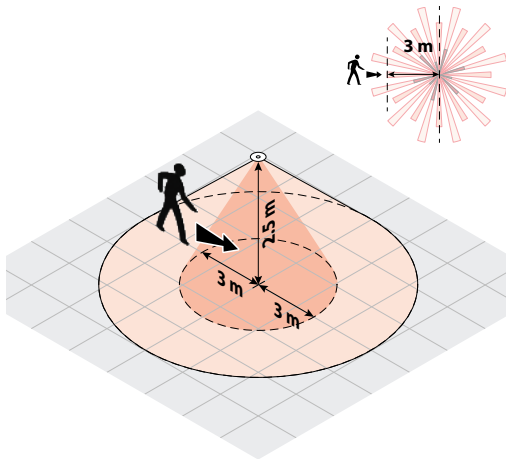

Transverse approach

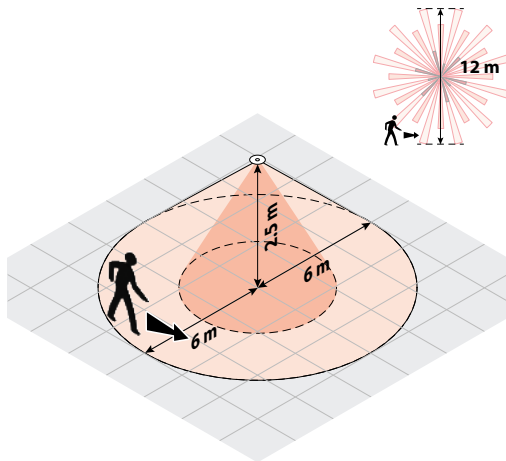

9.2 Maximum sensitivity

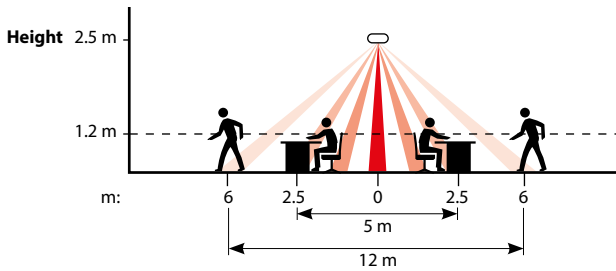

10. MODES

10.1 Auto ON/OFF

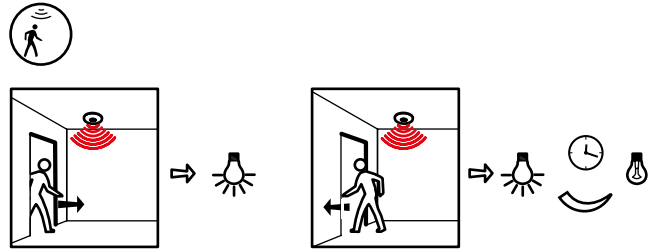

10.2 Manual ON/Auto OFF

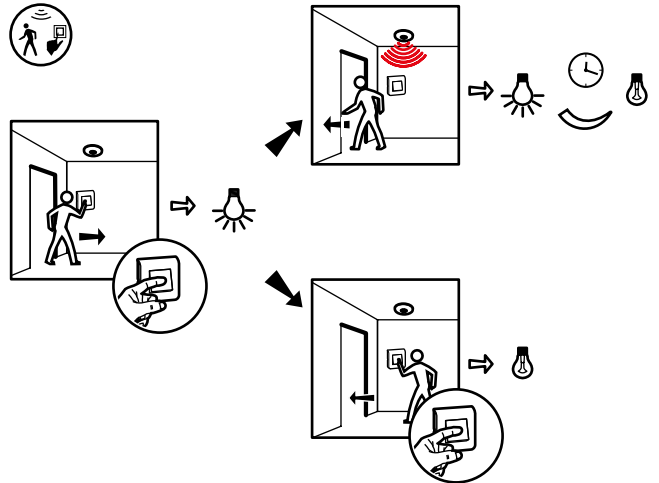

11. LEGRAND CLOSE UP APP

The sensor functions are controlled by a number of parameters which can be changed or programmed with the **Legrand Close Up** app.

Legrand Close Up can be used to view and change all the sensor parameters.

Exchanges between the sensor and the phone are via Bluetooth®.

Note:

Refer to the **Light Up technical guide** to find the description of procedures for setting up Light Up products.

Available to download from:



or



Direct access

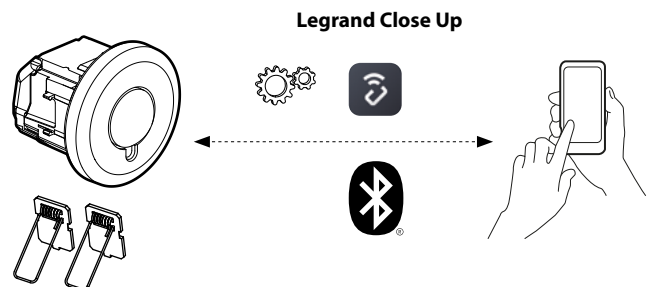

12. SETTINGS WITH CLOSE UP

12.1 Different product states

Warm-up: Initial state after switch-on, the lights are on, the presence sensor is in the preheating phase for 80 seconds. The presence LED is lit.

Initial: The product is ready to control lighting based on its parameters and its sensor measurements.

Test: Enabled by the installer or the expert, this state is used to check the presence sensor and its cover.

The settings are overridden except for PIR sensitivity, every time presence is detected the light comes on for 5 s.

This test is available for 10 minutes if specifically requested.

12.2. Detection settings

 **Time delay:** Length of time the load remains on after detection.

 **Sensitivity:** Detection range setting.

Detection LED: Comes on for 80 s when the product is commissioned. Comes on for 1 s to indicate presence detection. **Daylight setpoint:** Value at which the load switches on if the light level is less than the setting and goes off if it is above this setpoint.

Light contribution: Quantity of additional lux brought in by the load being switched on.

When the Light contribution parameter is set to 0, the sensor automatically calculates the light contribution.

 **Regulation:** Automatic switch-off of the load 10 minutes after the daylight setpoint is exceeded. If the level of light is below the daylight setpoint, the load is activated automatically after 20 seconds.

Standby level: Brightness level (as a percentage) to be applied during the pre-shutdown period.

Standby delay: The length of time the standby mode remains active before the device switches off.

NB: Choosing an unlimited duration allows there to be a minimum light level when no presence is detected.

Daylight level:

Light level value measured by the product.

12.3 Modes:

Auto on/Auto off mode:

The lighting switches on automatically:

- On detection of presence if the natural light level is insufficient.

The lighting switches off automatically:

- When no presence is detected and at the end of the set time delay.
- Or if the natural light level is sufficient (regulation enabled).

Any new detection triggers an automatic switch-on if there is insufficient light.

Walkthrough mode:

- If no presence is detected in the 20 seconds following an initial detection, the device will switch off the load after 3 minutes.
- If another movement is detected in the 3 minutes following initial detection, the device will switch off the load at the end of the set time delay.

Manual on/Auto off mode:

The lighting is switched on by a manual control, but switches off automatically:

- When no presence is detected and at the end of the set time delay.
- After switch-off, if another movement is detected within a 30-second period, the lighting switches on automatically.

12. SETTINGS WITH CLOSE UP (continued)

12.4 Advanced mode

Restart:

Function allowing automatic switch-on of the product after a period of 30 seconds following the load being switched off.

After switch-off, any new detection within a 30-second period triggers an automatic switch-on.

After more than 30 seconds the device must be switched on manually. Only if Manual on/Auto off mode is enabled.

Regulation speed:

Used to extend or reduce the load reaction time based on the light level measurement and user setpoint.

12. SETTINGS WITH CLOSE UP *(continued)*

TITLE	SETTING	VALUES	DEFAULT VALUE	CONDITIONS
CONFIGURATION				
Time delay	Minutes	0 to 59	15	
	Seconds	15 to 59	0	
Detection	PIR sensitivity	Low / Medium / High / Very high	High	
	Detection Led	Enabled / Disabled	Enabled	
	Occupancy status	<i>Read only</i>		
	Retriggering	Enabled / Disabled	Disabled	Only if mode is set to Manual ON / Auto OFF
Luminosity	Daylight setpoint	5 to 1275	300	
	Provision of light	0 to 1275	0	
	Luminosity regulation	Enabled / Disabled	Enabled	
	Standby level	1 to 100	10	
	Standby delay	No standby 5 sec. 10 sec. 20 sec. 30 sec. 1 min. 5 min. 10 min. 15 min. 20 min. 30 min. 60 min. No limit	No standby	
	Daylight factor	1 to 255	35	
	Daylight level	<i>Read only</i>		
	Natural daylight factor	1 to 255	10	
	Current provision of light	<i>Read only</i>		
	Lighting output type	Dimming / Non dimming	Dimming	
	Regulation speed	5 minutes at least 10 minutes at least 15 minutes at least 20 minutes at least 25 minutes at least	10 minutes at least	
	Functions	Mode	Auto ON / OFF Walkthrough mode Manual ON / Auto OFF	Walkthrough mode
Primary / Secondary		Primary Secondary	Primary	
VERSIONS				
Product version		<i>Read only</i>		
Zigbee IEEE		<i>Read only</i>		
Software - radio module		<i>Read only</i>		
Hardware - lighting module		<i>Read only</i>		
RADIO NETWORK				
PAN ID		<i>Read only</i>		
Channel		<i>Read only</i>		
Coordinator		<i>Read only</i>		
SENSOR STATUS				
Sensor status		<i>See details (access to a new screen)</i>		

Advanced settings

12. SETTINGS WITH CLOSE UP *(continued)*

12.5 Access to tools

Commands	<p>Reboot Allows the product to be rebooted in the event of faulty operation.</p>
	<p>Factory reset By pressing the button on the app or by holding down the Reset button for 5 seconds. The radio LED flashes red, then the device restarts. Results: The settings are reset to their default values. The radio settings (connection, network table) are cleared. The device reverts to a non-secure state.</p>
	<p>Dissociate from the project The product is returned in a non-secured state. It can be linked to a new project.</p>
	<p>Join radio network When the button on the app is pressed, the device attempts to connect to an open wireless network. The radio LED flashes magenta during the operation (max. 180 s). If successful, the LED turns solid magenta. Otherwise, it turns solid red. During the operation, other radio commands are unavailable. You can stop the procedure by pressing this button again (the LED turns solid red).</p>
	<p>Leave radio network If the device is the network coordinator (see parameter chart) the network is terminated. All devices are removed from the network. If the device is not the coordinator, it withdraws from the network.</p>
	<p>Open radio network Opens the radio network for 180 seconds (the radio LED turns a steady magenta). During this time, you can add devices to the network. If the device does not belong to a network, it creates its own network.</p>
	<p>Close radio network Closes the radio network (the radio LED goes out). It is therefore no longer possible to add devices to the network.</p>
	<p>Initial state* This command puts the unit into warm-up mode, which can help the installer check several key points (daylight setpoint, detection, automation).</p>
	<p>End of time delay* Clears the current time limit.</p>
	<p>Walk test* Useful for testing the detector's range of coverage. This mode allows you to override all settings except for PIR sensitivity for 10 minutes. Each detection turns on the presence indicator light (if the relevant setting is enabled) and activates the lighting for 5 seconds. After these 5 seconds, if no presence is detected, the lighting switches off; otherwise, the 5-second timer is reset.</p>

* Command dedicated to checking the product's performance, mainly used by the installer or expert.

12. SETTINGS WITH CLOSE UP *(continued)*

Modules	<p>Manage Legrand wireless devices Allows you to add or remove switches and/or sockets.</p>
	<p>Sensor calibration Allows you to set two reference values (lux): lights on/shutters closed and lights off/shutters open. After pressing this button, follow the described procedure.</p>
	<p>Primary / Secondary installation The primary detector controls the load(s). The secondary detector extends the detection range but does not directly control any loads. By default, the detector is set to primary mode.</p>





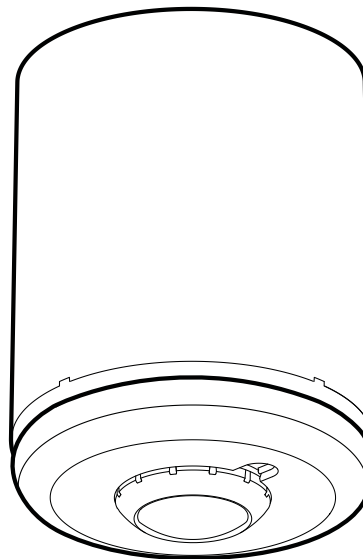

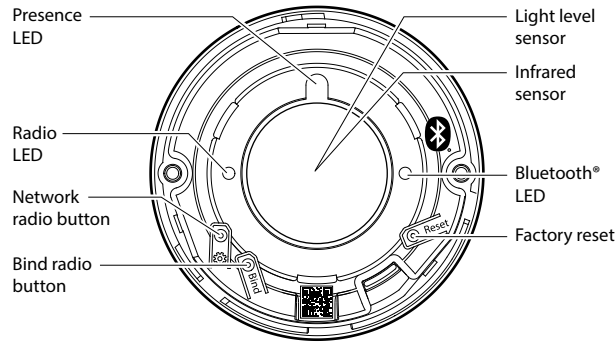

13. SURFACE-MOUNTING ACCESSORY

Surface-mounted installation using accessory Cat. No. **0 485 80**. Follow the instructions supplied with the accessory.



14. DESCRIPTION OF BUTTONS AND LEDs



Network radio button	< 0.5 s Join a network/Open and close network > 5 s Radio reset	
Bind button	< 0.5 s Network creation/Initiator binding > 5 s Target Binding	
Reset button	< 0.5 s Reboot > 5 s Factory reset	
Radio LED	Failure of network creation, joining a network or binding. Product reset (<i>red flash</i>)	Red flash 
	The product is in a radio network, the network is open.	Steady magenta 
	After the Network button is pressed: attempt to join a radio network. It changes to steady magenta if the operation was successful. If not, the LED flashes red 5 times.	Flashing magenta 
	Binding procedure in progress	Flashing blue 
	Updating	Flashing cyan 
	Product anomaly, reboots 15 s after the anomaly	Steady white 
	Product start-up	Steady yellow 
Presence LED	In pre-heating state (commissioning) the LED stays on for 80 s. Each time movement is detected, the LED comes on for 1 s.	Steady green 
Bluetooth® LED	Is on when the product is paired with a smartphone.	Steady blue 

15. STANDARDS

Installation standards: NFC 15-100
 Product standards: EN 50428
LVD "Low Voltage Directives":
 • Directive → 2014/35/EU
 • Standard → NF EN IEC 60669-2-1:2022
EMC "Electromagnetic compatibility":
 • Directive → 2014/53/EU
 • Standard → NF EN IEC 60669-2-1:2022
 ETSI EN 301489-1
 ETSI EN 301489-17
RED (radio equipment):
 • Directive → 2014/53/EU
 • Standard → ETSI EN 300 328 v2.2.2:2020
 IEC62311:2020
RoHS (Restriction of Hazardous Substances):
 • Directive → 2011/65/EU
 2015/863/EU
EC directives:
 • European Directive 2002/96/EC:
 WEEE (Waste Electrical and Electronic Equipment)
 • EC Directive 2002/95/EC:
 RoHS (Restriction of Hazardous Substances)

16. CARE

Keep the lens clean.
 Clean the surface with a cloth.
Do not use acetone, tar-removing cleaning agents or trichloroethylene.
 Resistant to the following products: - Hexane (EN 60669-1)
 - Methylated spirit
 - Soapy water
 - Diluted ammonia
 - Bleach diluted to 10%
 - Window cleaning products

Caution:

Always test before using other special cleaning products.

17. TROUBLESHOOTING

Problem	Causes	Solutions
The lighting stays on when there is no-one present	Sources of interference such as draughts, vibration or radiators may cause nuisance tripping	1- Reduce the sensitivity level 2- If the interference still continues, move the sensor away from sources of interference
The lighting does not switch off during the day when there is an adequate natural light level	Regulation function inactive Daylight setpoint too high Too much light provided	Enable the Regulation function Reduce the daylight setpoint Check that the sensor is positioned correctly in relation to the window Decrease the power of the luminaires
The lighting switches off when there are people present and the natural light level is not adequate (darkness)	Time delay too short Detection sensitivity too low Daylight setpoint too low	Increase the Time delay 10 to 1 minutes is recommended for work areas Increase the Sensitivity Move the sensor closer to the work area Increase the Threshold