

0 337 50/51



0 337 53/54

CONTENTS

Page

1. General characteristics	1
2. Positioning	1
3. Technical characteristics of panel ...	2
4. Technical characteristics of connectors	2
5. Performance a 20°	2
6. Dimensions	2
7. Typical rj45 connection.....	2
8. Accessories	3
9. Standards.....	3
10. Performances.....	3

1. GENERAL CHARACTERISTICS

Equipped with new-generation Soluclips for automatic fixing (screwless) on cabinet and enclosure uprights (the soluclips are designed to adapt to uprights of thickness ranging from 1.5 to 2mm max).

Universal mounting in all racks or cabinets with automatic earthing on unpainted uprights. Painted uprights can be connected to earth with a cord and a screw connection.

Equipped with rear cable guide to hold cable during maintenance.

Equipped with 4 cassettes of 6 LCS³ RJ45 Cat. 5E connectors with toolless fast connection, marked 568 A/B.

Supplied with different colour identification labels for each cassette (blue, white, yellow, orange).

The connectors are compliant to all performance, mechanical, climatic and electromagnetic requirements of the ISO/IEC 11801-1.

The connectors are compliant NF C90 483. They supports radio frequency signals up to 2150MHz on the pair "7/8".

19" panel - 1 U

Cassettes removed automatically by simply pressing the button on the front.

Each connector can be removed individually.

2. POSITIONING

Connectors are connected at the front without a special tool.

- Connectors clip onto the panel individually

Cable ties not required. Cables are maintained in position by dedicated support in the cassette and on the panel.

Mounting a panel

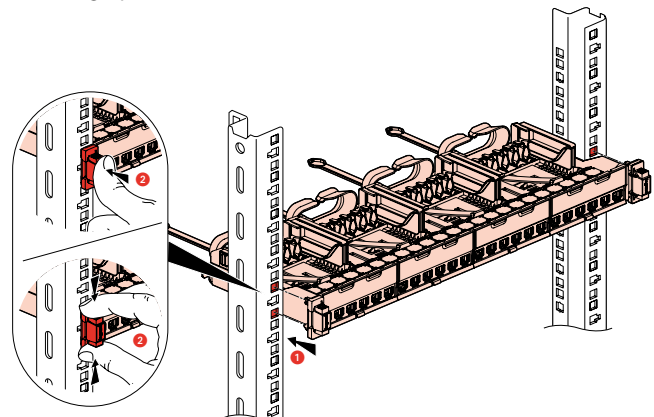

Mounting a cassette

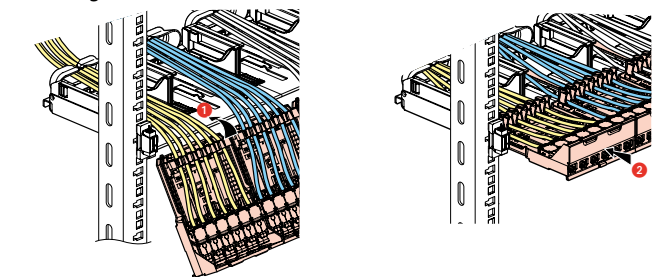

Removing a cassette

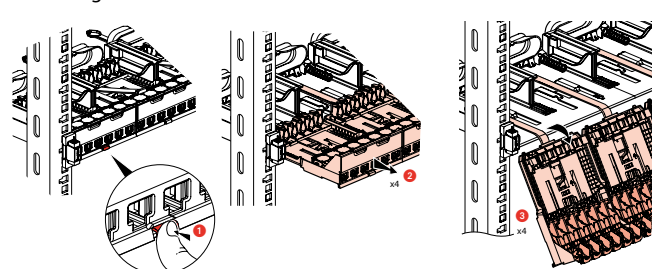

Description	UTP	FTP	Weight (g)
Panel with 24 RJ45 Cat. 5e UTP	0 337 50		1786
Panel with 24 RJ45 Cat. 5e FTP		0 337 51	1786
Connector with 6 RJ45 Cat. 5e UTP	0 337 53		11
Connector with 6 RJ45 Cat. 5e FTP		0 337 54	11

3. TECHNICAL CHARACTERISTICS OF PANEL

3.1 Material characteristics

Panel: DC01 galvanised sheet steel.

3.2 Electrical characteristics

Automatic grounding of cassette to panel
Automatic grounding of panel to uprights through unpainted contact area.
Ground lug on panel if additional grounding necessary.

3.3 Mechanical characteristics

Fixing to uprights without screws: Upright thickness 1.5 to 2mm
For fixing to uprights outside tolerance, Soluclip can be removed and replaced by screws.

4. TECHNICAL CHARACTERISTICS OF CONNECTORS

4.1 Mechanical characteristics

Maximum 20 cable re-termination according to following options:

Test method	Cable AWG
IEC 60352-3	22 to 24 ⁽¹⁾
IEC 60352-3	24 to 26 ⁽¹⁾
Single AWG	22 or 23 or 24 or 25 or 26 ⁽²⁾

⁽¹⁾ Re-termination of any mix of conductor sizes within that range.

⁽²⁾ Re-termination on only 1 conductor size. No mix allowed.

Endurance: 2500 movements (plug insertion/withdrawal) according to ISO/IEC 11801-1 PL2.

4.2 Material characteristics

Contacts: Gold/nickel, minimum thickness of gold > 0.8 µm.
Metal parts: Bronze, nickel, platinum, gold.
Polycarbonate PBT.

4.3 Electrical characteristics

Breakdown voltage ≥ 1000 V.
Contact resistance ≤ 20 MΩ.
Insulation resistance ≥ 500 MΩ at 100 Vdc.
"Tested and independently certified to comply with IEC 60512-99-001 and IEC 60512-99-002 for PoE support up to 90w (Type 4)."

4.4 Climatic characteristics

Storage temperature : 10°C to +70°C
Operating temperature : -10°C to +60°C

5. PERFORMANCE A 20°

Maximum length of Permanent Link based on architecture

	Maximum cord length*	Maximum Permanent Link	Total Channel
2 Connector Channel	10m	89m	99m
3 Connector Channel	10m	88m	98m
4 Connector Channel	10m	87m	97m

* = sum of 2 cords

Note: calculations based on ISO/IEC 11801. Legrand products support the 100m 2-connector channel, confirmed by laboratory testing

6. DIMENSIONS

Dimensions of panels 0 337 50/51

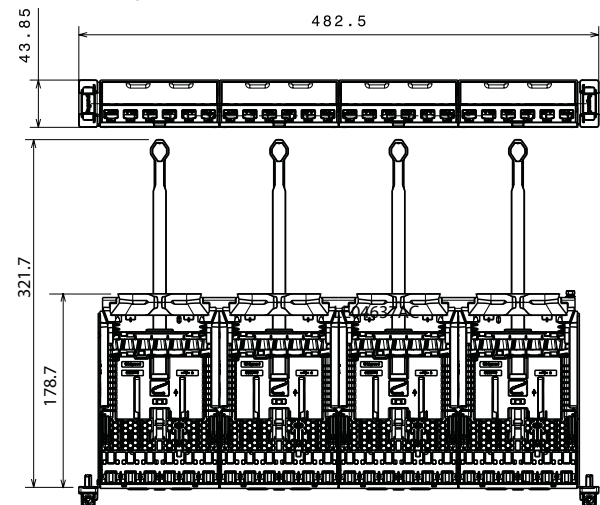

Dimensions of connectors 0 337 53/54

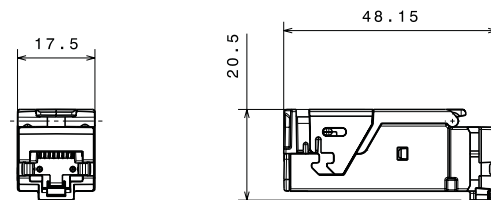

7. TYPICAL RJ45 CONNECTION

Connectors accept the following plug types:
RJ11 (4 contacts), RJ12 (6 contacts), RJ45 (9 contacts).
Connectors accept the following cable types:

Connector type	Cable type
UTP	UTP, U/UTP
FTP	FTP, STP, F/UTP, U/FTP, F/FTP, S/FTP, SF/UTP, SF/FTP

TIA 568 A and B dual colour code :

- UTP (8 contacts)
- FTP (9 contacts)

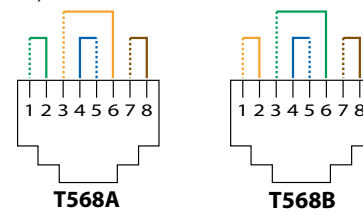

Colour code and contact number

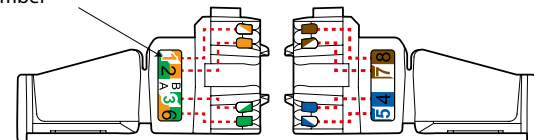

Identification number
UTP : HD 01
FTP : HD 02

Category colour code :
Cat. 5e grey

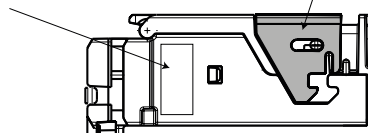

7. TYPICAL RJ45 CONNECTION (continue)

Permissible conductors:

- Solid/Stranded : 0.4 to 0.65 mm, AWG 26 to 22
- Polyethylene conductor insulation: Ø 0.85 to 1.7 mm on insulation

Number of wires to be connected per connection: 1

RJ45 connectors are equipped with a locking nut. They do not require a special tool and can be re-wired if a mistake is made.

8. ACCESSORIES

- **0 337 57:** Blanking cassette

Used to fill gaps in the panel.

- **0 337 57:** Port blanking plate

Blanking plate with 6 separable ports

Used to block up individually, partially or fully 1 to 6 ports (cassette with 6 ports) or 1 to 12 ports (HD cassette).

- **0 337 59:** Cable guide

2 cable guides to be clipped onto new-generation Soluclips.

Manages cables laterally by holding them and tilting them horizontally and vertically.

Each cable guide is guaranteed to hold up to 12 Cat5e cords

9. STANDARDS

ISO/IEC 11801 series : International standard for generic cabling for customer premises

ANSI/TIA 568 series : North American standard for generic cabling for customer premises

EN 50173 series : European standard for generic cabling for customer premises

IEC 60603-7 series : International standard for connector specifications

Connectors are compliant to requirements for the following remote powering applications

IEEE 802.3af , IEEE 802.3at , IEEE 802.3bt : "Power over Ethernet", Types 1 to 4, up to 90w.

The connectors are compliant NF C90 483.

10. PERFORMANCES

10.1 Permanent link performances with U/UTP cable

The red line represents the limit line of standard, the black one, the extension of the limit line of standard.

Return loss

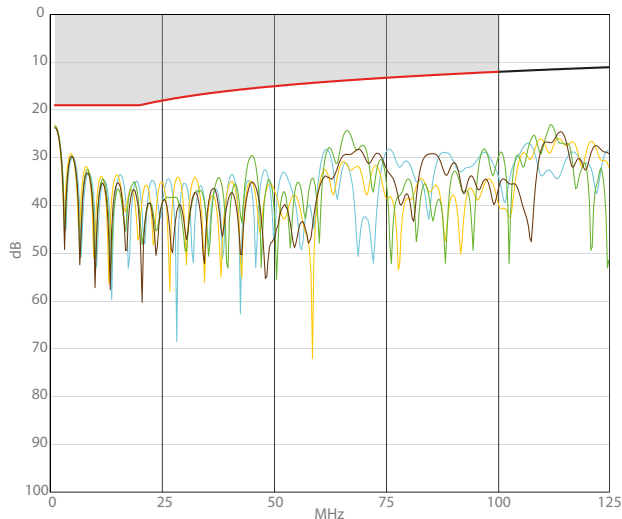

Attenuation

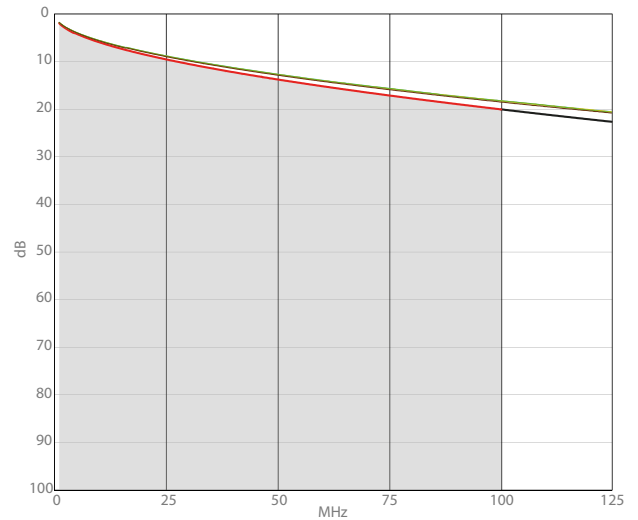

NEXT (Near end Crosstalk Attenuation)

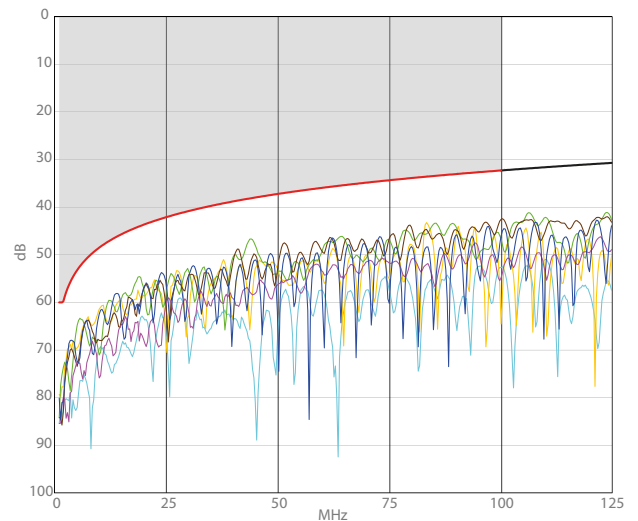

PS NEXT (Power Sum NEXT)

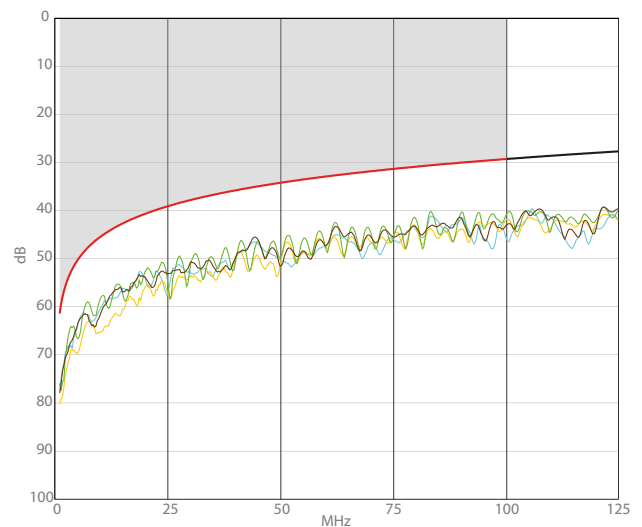

10. PERFORMANCES (continue)

■ **10.1 Permanent link performances with U/UTP cable (continue)**

ACR (Attenuation to Crosstalk Ratio)

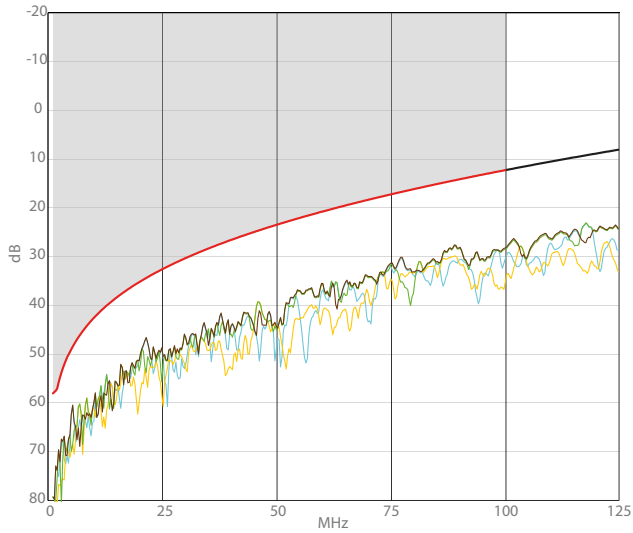

Attenuation

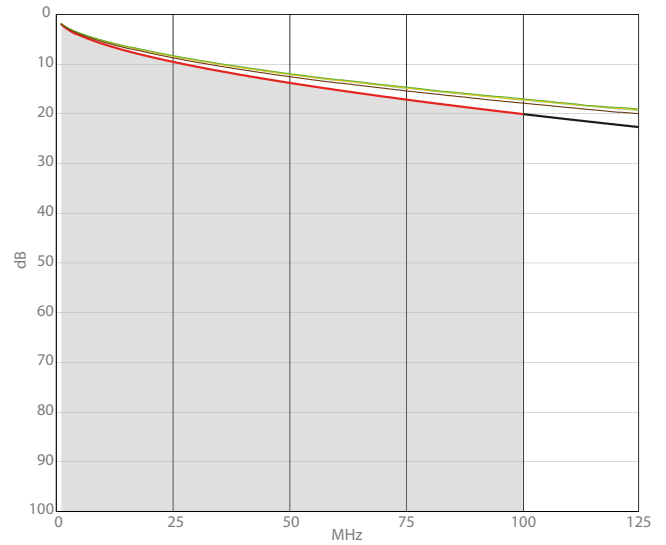

ELFEXT (Equal Level End Crosstalk Attenuation)

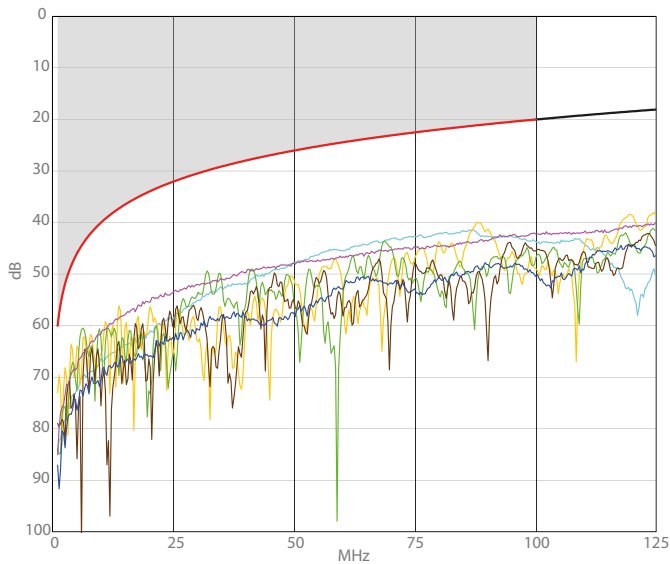

NEXT (Near end Crosstalk Attenuation)

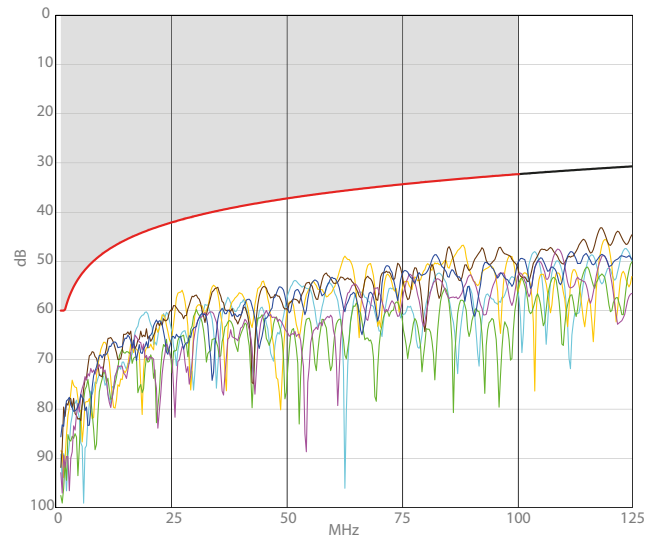

■ **10.2 Permanent link performances with F/UTP cable**

Return loss

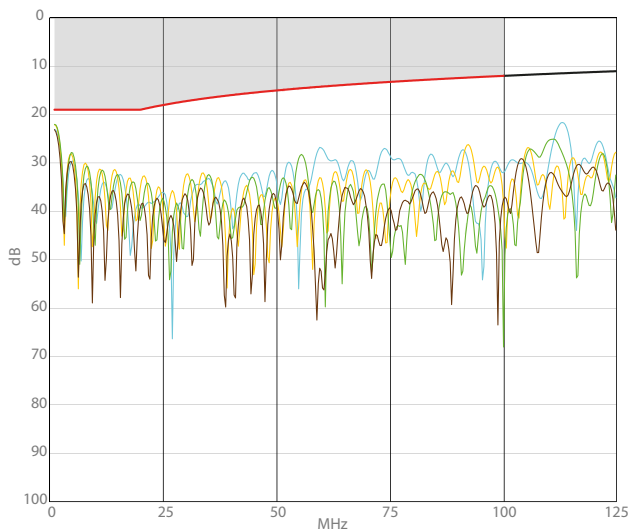

PS NEXT (Power Sum NEXT)

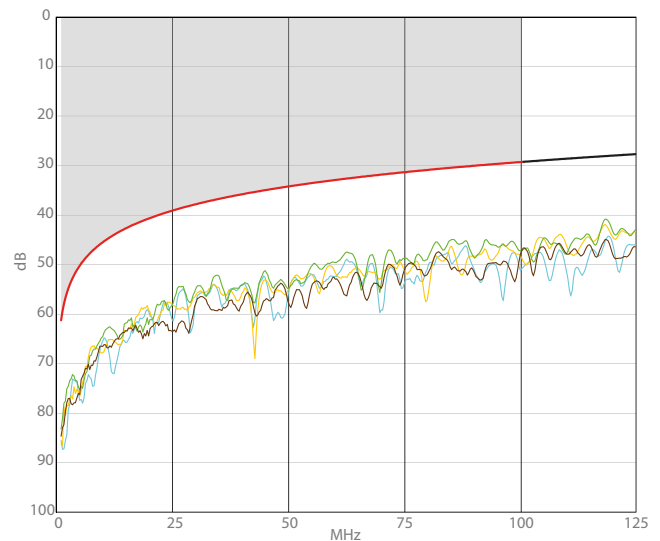

10. PERFORMANCES (continue)

■ **10.2 Permanent link performances with F/UTP cable (continue)**

ACR (Attenuation to Crosstalk Ratio)

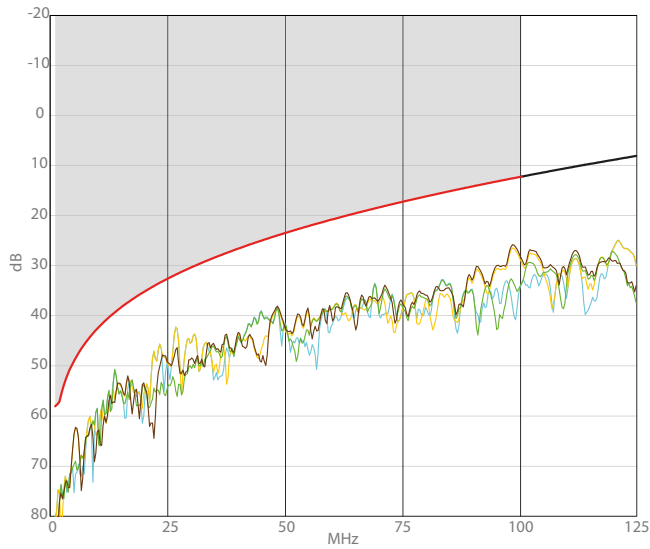

ELFEXT (Equal Level End Crosstalk Attenuation)

