



# Classe100 X16E

User and installation manual

**bticino**



## Contents

<b>Quick guide</b>	<b>5</b>
Answer a call	5
Auto-switching on and camera scrolling	7
Call another room or apartment (intercom)	9
Dissociate a smartphone	11
Dissociate an user	12
Customise the home page of the Door entry Classe100X App	14
<b>General information</b>	<b>16</b>
Warnings and recommendations	16
Warnings and consumer rights	17
Front view	18
Function keys and status LEDs	18
Rear view	20
<b>Installation</b>	<b>21</b>
Dimensional data and recommended installation heights	21
Wall-mounted installation	21
Installation on the tabletop bases 344692 (optional)	23
Configuration	25
Programming of the programmable keys	26
<b>Use from the device</b>	<b>33</b>
<b>Functions</b>	<b>33</b>
Answer a call	33
Call another room or apartment (intercom)	34
PE or cameras direct auto-switching on	36
NETATMO cameras	38
Door lock release	41
Paging	42
<b>Services</b>	<b>43</b>
Inductive loop	43
Door status	44
Professional Studio (Office)	45
Safe door lock	46
<b>Device adjustments and settings</b>	<b>47</b>
Use of the joystick	47
Wi-Fi adjustments and settings	48
Settings	59
<b>Use with the Door entry Classe100X App</b>	<b>62</b>
<b>Introduction</b>	<b>62</b>
<b>Account registration</b>	<b>63</b>
<b>Authentication</b>	<b>65</b>
<b>Forgotten password</b>	<b>66</b>
<b>Help</b>	<b>67</b>
FAQ	68
Sending log	68
<b>Association of the device</b>	<b>69</b>
<b>Home page</b>	<b>78</b>
Display the cameras or Entrance Panels	79
Open door locks	81
Staircase Lights	81
To receive a video door entry call	82
Call home: Call your Classe100 X16E	86

<b>Menu</b>	<b>88</b>
Users	89
Settings	94
Account	108
NETATMO cameras	117





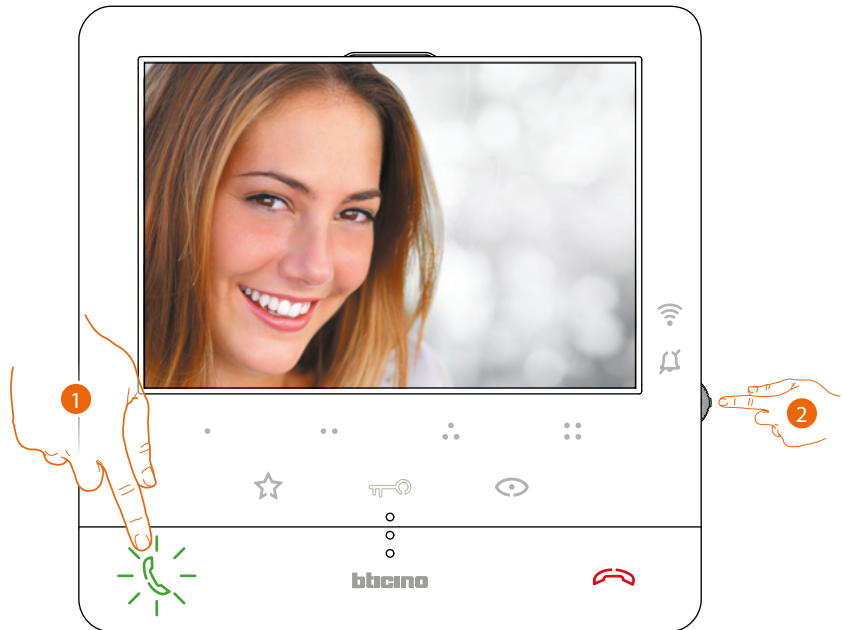

## Quick guide

### Answer a call



1. Touch to answer the call.
2. If necessary, during the call press the joystick to display the audio/video parameter adjustment icons.



3. Move the joystick up/down to select the type of parameter for which you want to modify the value (see the following table) among:
  -  Speaker volume (Parameter that can be adjusted only with active audio);
  -  Image brightness;
  -  Image contrast;
  -  Image colour.

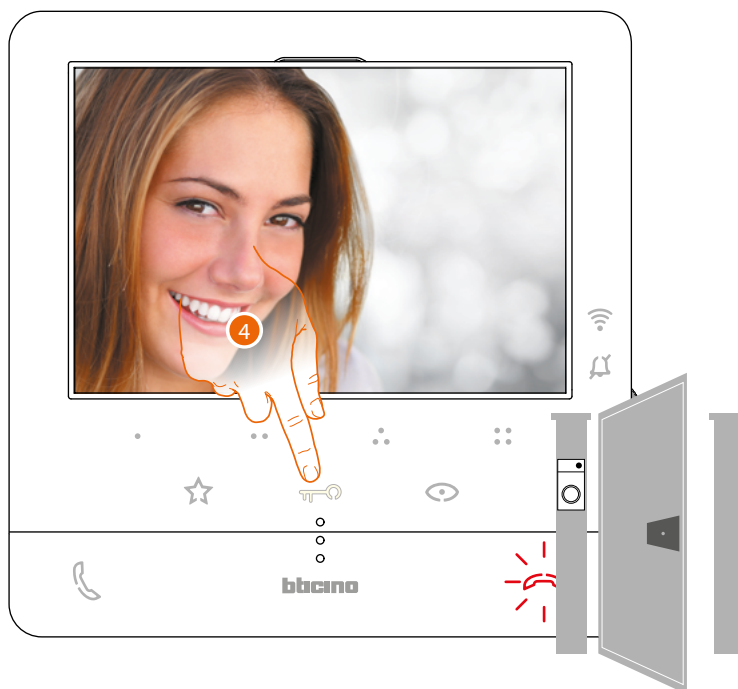

4. Touch to open the main Entrance Panel door lock

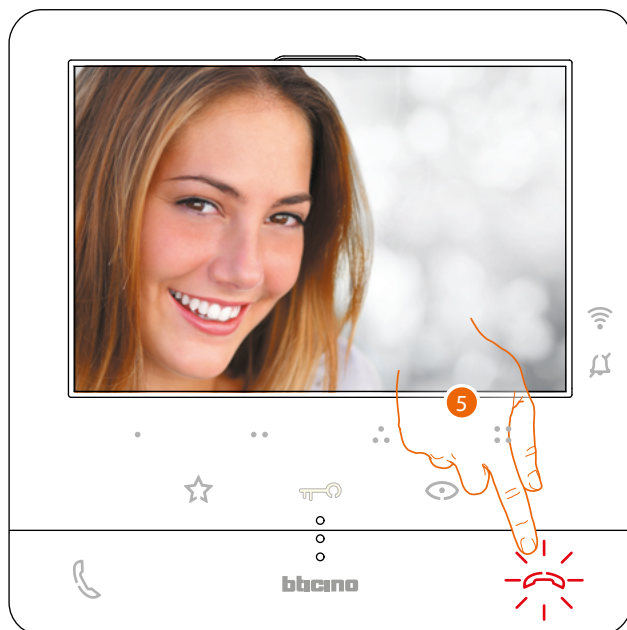

5. Touch to end the call.

## Auto-switching on and camera scrolling

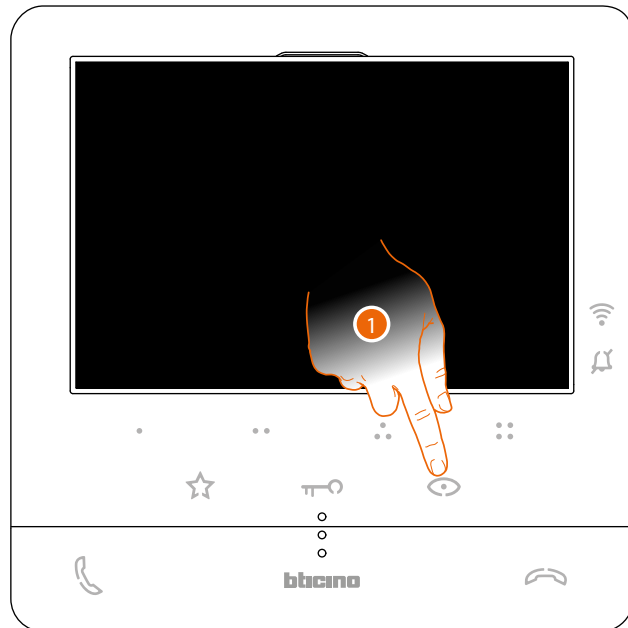

1. Touch to display the Entrance Panels or the cameras in your system.

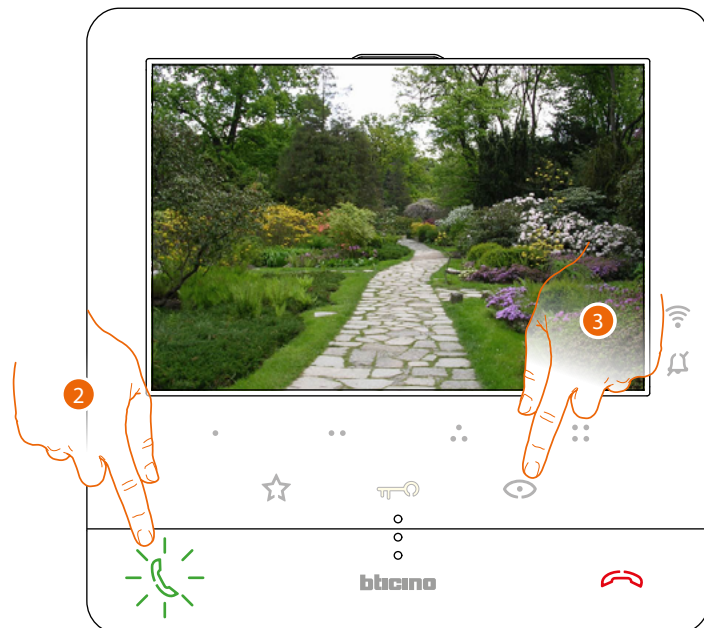

2. If necessary, touch to activate the audio communication
3. Touch to display another Entrance Panel or camera (using the scrolling service). When switching from one camera to the next the key lights up.

**Note:** switching from one camera to another is also possible without enabling the audio.

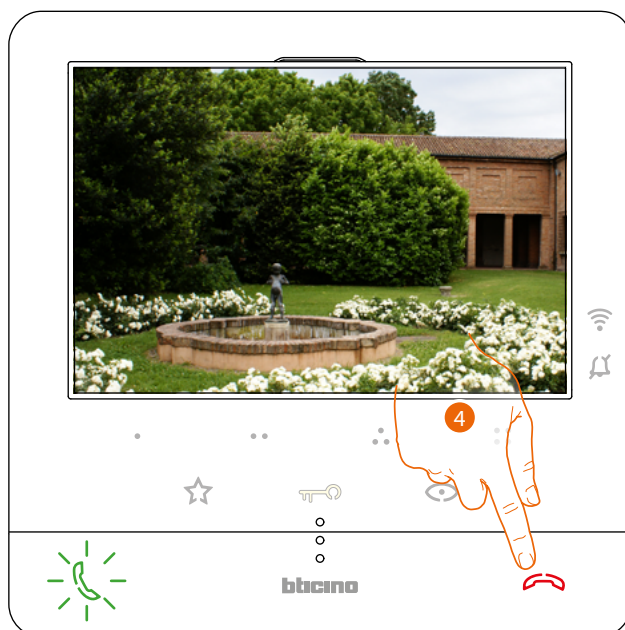

4. Touch to end camera display mode, or wait for the automatic switch off time to elapse.

## Call another room or apartment (intercom)

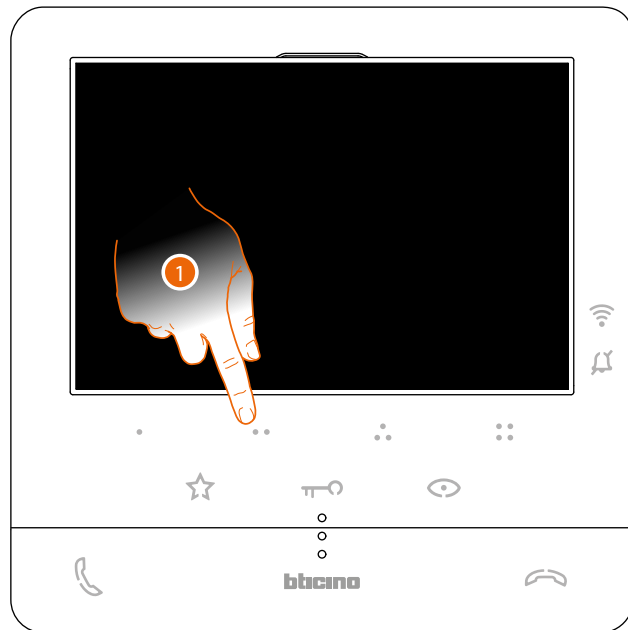

1. For example, touch programmable key ●● to activate the communication with the Internal Unit (e.g. configured as 2)

**Note:** the programmable key to use for calling a certain Internal Unit is set by the installer (see [Programming of the programmable keys](#)).

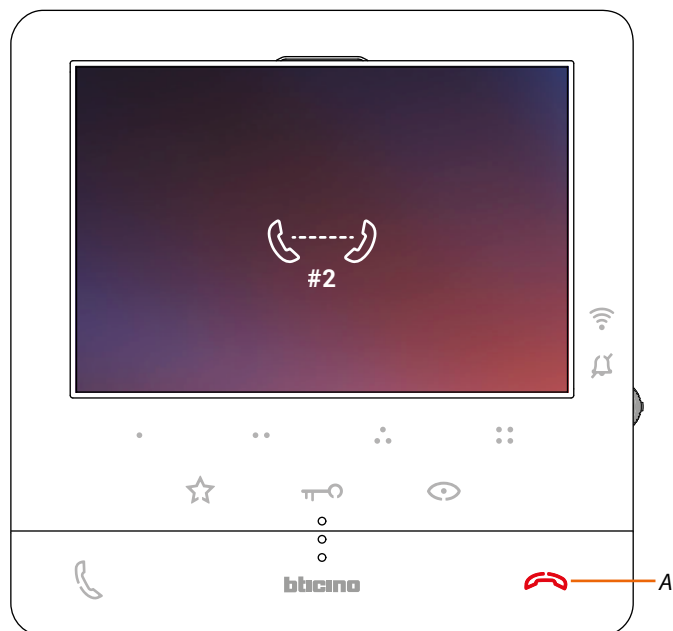

Key (A) lights up to indicate that the call is active.



When the Internal Unit answers, the key starts flashing. Touch it to end the call or establish communication with the Internal Unit.

**Note:** if during the conversation a call is received from the Entrance Panel, the conversation is interrupted in order to answer the Entrance Panel call.

## Dissociate a smartphone

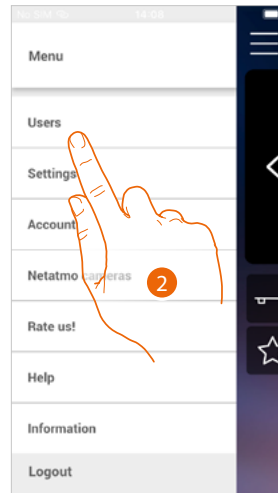
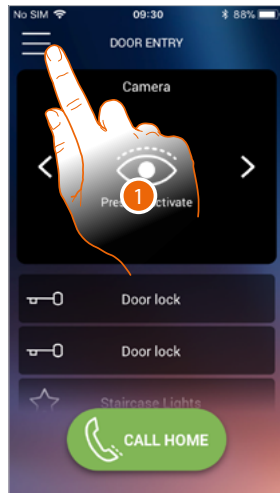

1. Touch to open the pull-down menu.
2. Touch to open the user section.
3. Scroll to dissociate a smartphone.

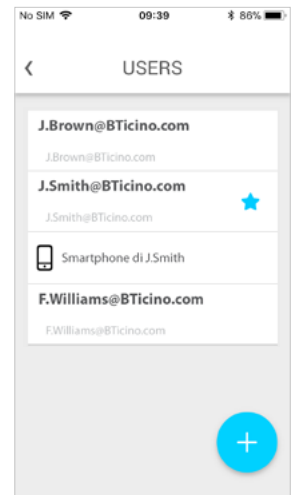
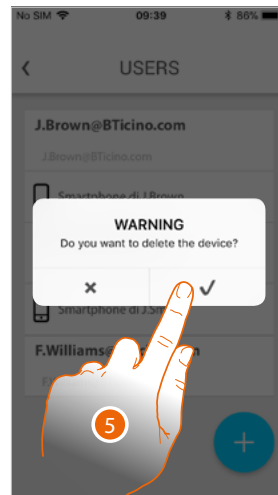
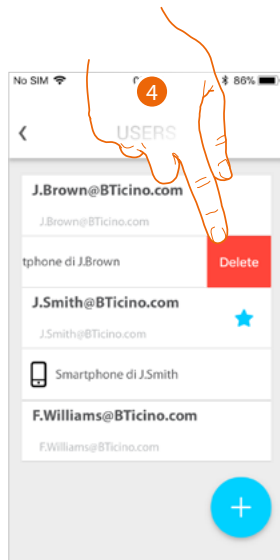

4. Touch to continue.
5. Touch to confirm

The user will no longer be able to manage the system using that smartphone.  
To re-associate the smartphone simply repeat the **authentication** process.

## Dissociate an user

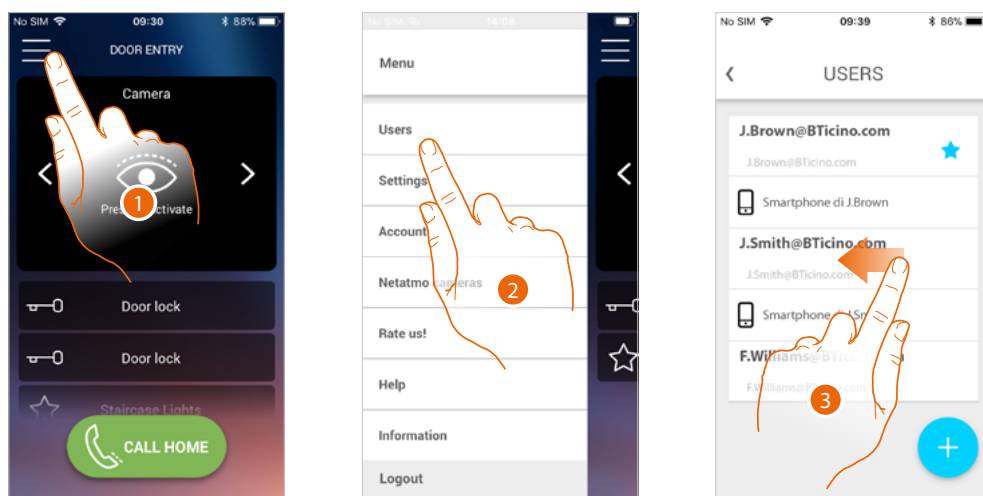

1. Touch to open the pull-down menu.
2. Touch to open the user section.
3. Scroll to dissociate a user, and therefore all the devices associated with the same.

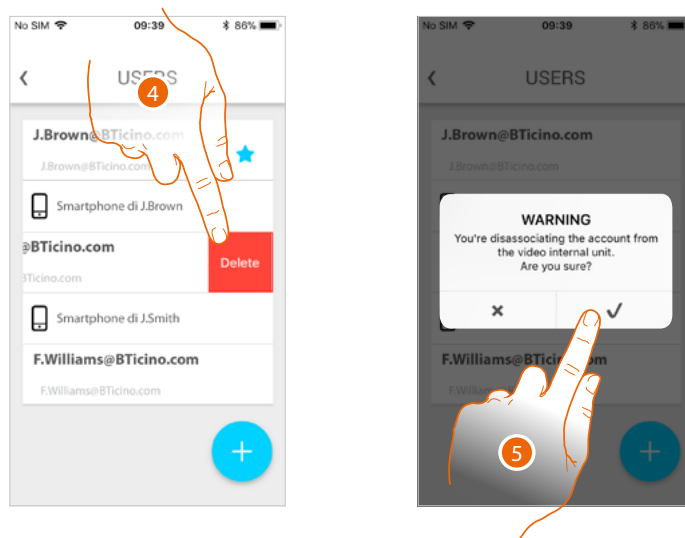

4. Touch to continue.
5. Touch to confirm



If your user is the main user, and you want to delete it, it will be necessary to indicate a replacement as main user.

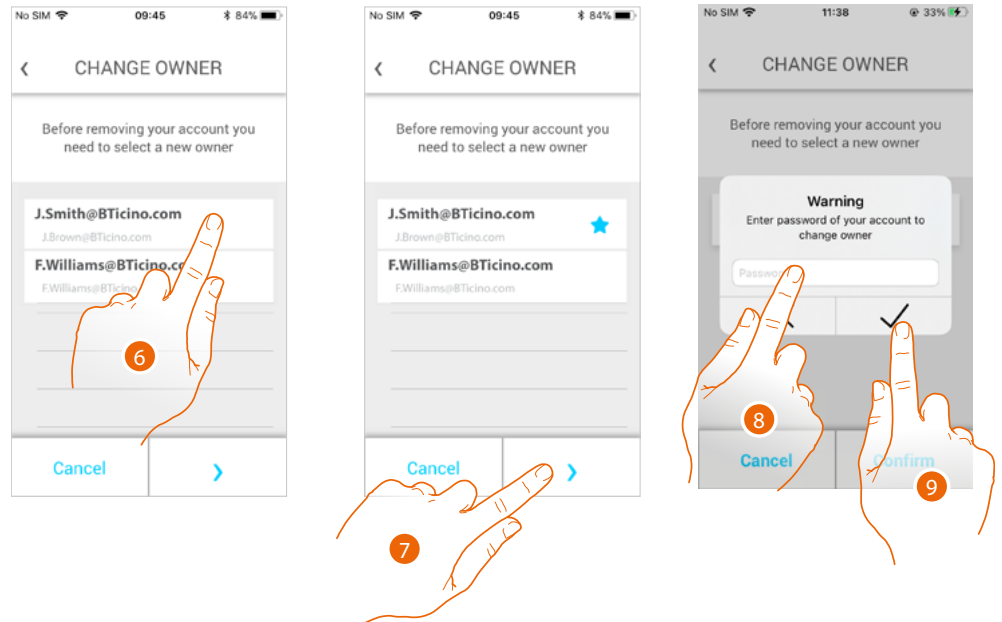

6. Touch to indicate the new main user.
7. Touch to continue.
8. Enter the password of your user.
9. Touch to confirm. You will be redirected to the home page.

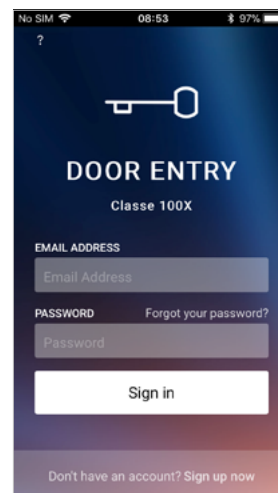

Now you have been dissociated. To return to manage the system, you must be invited again.

**Warning:** if the user to dissociate is the only one left, the system will suggest a tutorial to reset the device.

## Customise the home page of the Door entry Classe100X App

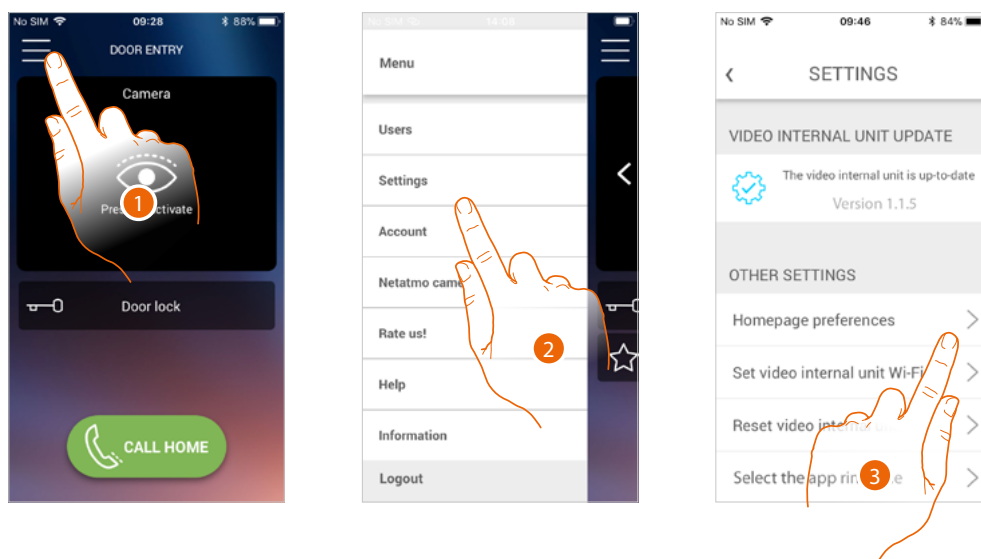

1. Touch to open the pull-down menu.
2. Touch to open the setting section.
3. Touch to customise the Home page

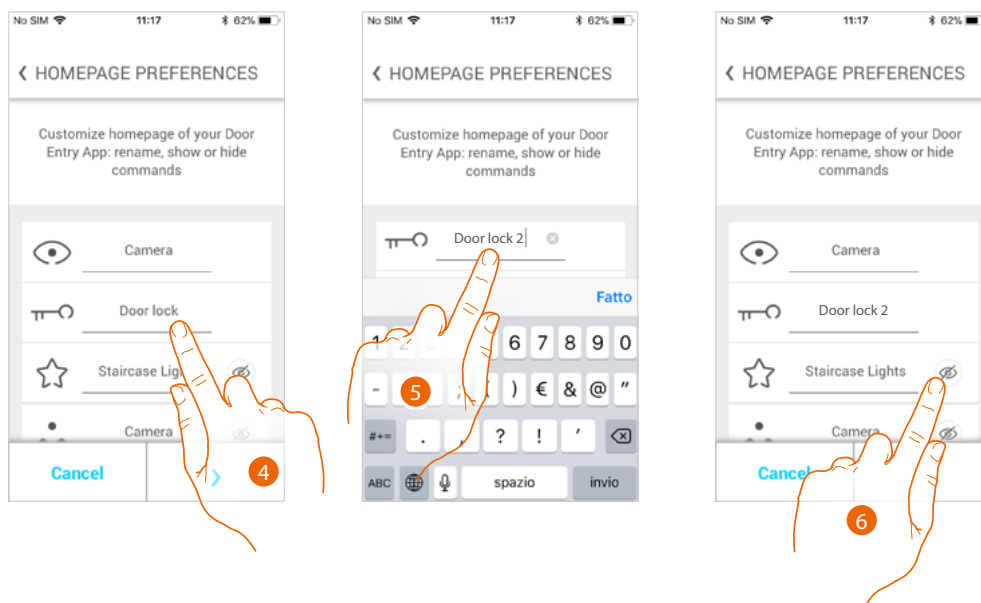

4. Touch to modify the description of the main EP door lock
5. Enter the new description
6. Touch to display the Staircase Light key on the home page

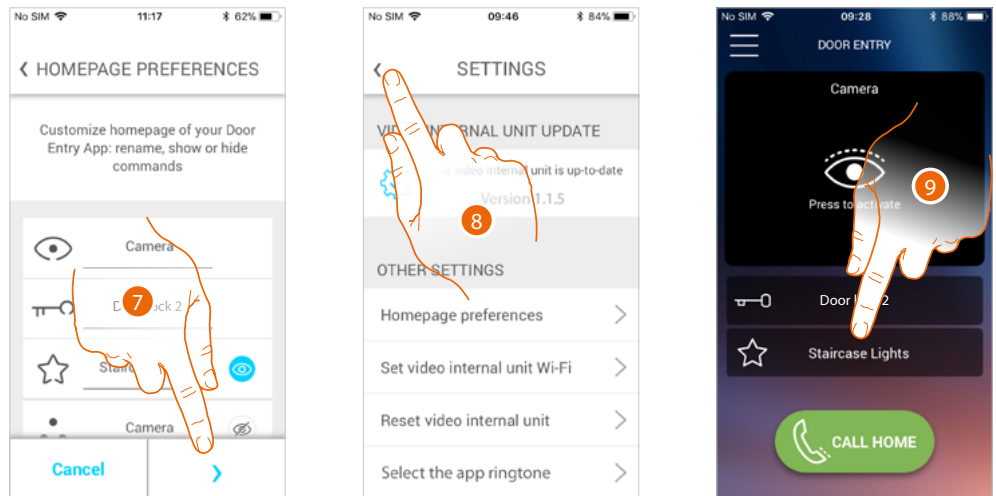

7. Touch to confirm the modifications.
8. Touch to return to the home page.
9. Now the staircase light key is available.

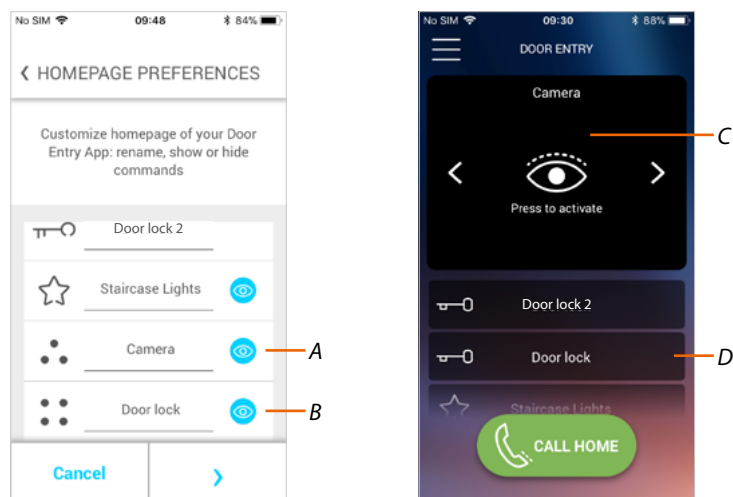

In addition to the Staircase Light key, it is also possible to show on the homepage the Entrance Panels/ Cameras (A) and Door Locks (B) corresponding to the programmable keys of your Classe100 X16E.

The Cameras/Entrance Panels will be available in the appropriate area (C), while for the Door Locks there is a dedicated key (D).

**Note:** the number and types of objects available for customisation depend on the way your installer has configured Classe100 X16E (see [Programming of the programmable keys](#)).

## General information

The Classe100 X16E video internal unit must be connected to a Wi-Fi network with the following features:

- IEEE 802.11 b/g/n (2,4 GHz) 13 channels
- Encrypting and authentication methods supported:
- OPEN WPA-PSK networks
- TKIP WPA2-PSK included
- included AES WEP 64 bits (ASCII 5 figure or hexadecimal 10 figure codes)
- WEP 128 bits (ASCII 13 figure or hexadecimal 26 figure codes)
- WPS authentication (supported for WPA2-PSK)

## Warnings and recommendations

It is important to read this manual carefully before proceeding with the installation.

The warranty becomes automatically void in case of negligence, improper use, tampering by unauthorised personnel.

The Classe100 X16E video internal unit must only be installed indoors; it must not be exposed to water drops or splashes; it must be used only on BTicino 2 WIRES digital systems.

**Note:** this device includes the Open Source software. For license and software information, connect your Windows/Linux PC to the device through the mini-USB port.

**Note:** a domestic Wi-Fi with internet access is needed for the connection between the Classe100 X16E video internal unit and the smartphone.

To use the service, the Customer must acquire the technical equipment which allows access to the Internet, on the basis of an agreement made by the Customer himself with an ISP (Internet Service Provider). BTicino plays no part in this.

The customer must install the Door Entry CLASSE100X app on his smartphone so that he can use some services which BTicino supplies as extras to the normal basic functions of the Classe100 X16E.

The services offered by means of the app require being able to interact with Classe100 X16E remotely and through the Internet.

In these cases the integration and good working between Classe100 X16E and app may depend on:

- a) quality of the Wi-Fi signal;
- b) type of access contract to the home internet;
- c) type of data contract on the smartphone;
- d) configuration of the router.

When one of these 4 elements does not conform with the specifications required for product operation, BTicino accepts no responsibility for any faults.

The Door Entry CLASSE100X app operation with screen off (background) may be compromised by the applications installed on the smartphone that:

- optimise the use of the battery and the energy saving;
- protect the device (antivirus or similar programs)

The product in fact supports a VoIP streaming system. You must therefore check with your smartphone data network contract that it does not block it.

We would like to inform you that the service provided by BTicino by means of remote use via the app involves the use of data. The cost linked to data usage depends on the type of contract which the customer has with his ISP (Internet Service Provider) and is solely the customer's responsibility.

## Warnings and consumer rights

---



Read carefully before use and keep for future reference

---



Touching the units with wet hands is forbidden.  
Using liquid cleaners or aerosols is forbidden.  
Blocking the ventilation openings is forbidden.  
Modifying the devices is forbidden.  
Removing protective parts from the devices is forbidden.  
Exposing the unit to water drops or splashes is forbidden. Installing the units near heat/cold sources or hot/cold air emission points is forbidden.  
Installing the units near heat/cold sources is forbidden.  
Installing the units near harmful gases and powders is forbidden.  
Fastening the units on unsuitable surfaces is forbidden.

---



Danger of electrical shock

---



Risk of devices falling because the surface on which they are installed collapses or inappropriate installation  
Switch the power supply OFF before any work on the system  
Remote operation may cause damage to people or property.

---



Caution: Installation, configuration, starting-up and maintenance must be performed exclusively by qualified personnel.  
Check that the wall installation has been carried out correctly according to the installation instructions.  
Check that the unit installation complies with the standards in force.  
Connect the power supply wires as indicated.  
Use only the items indicated in the technical specifications for any system expansions.

---

### Front view

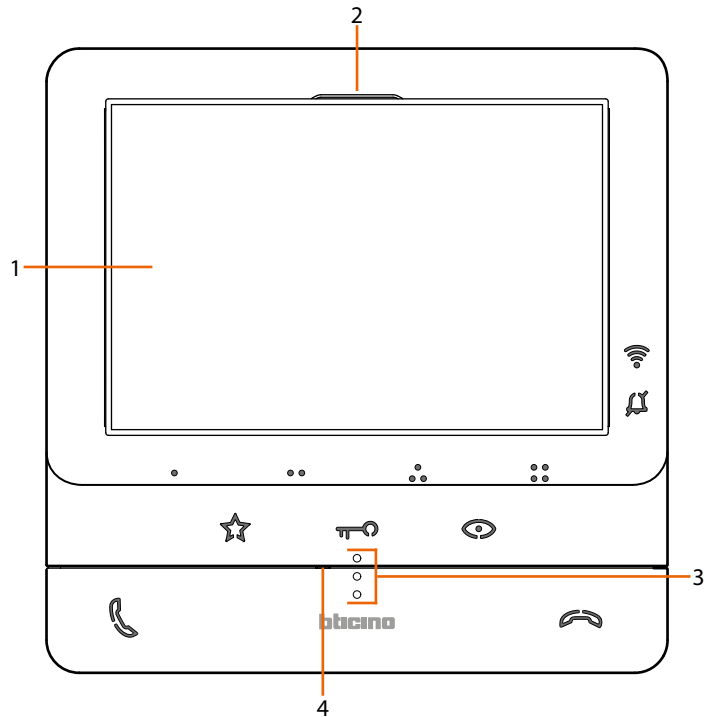

- 1. 5" (16:9) display
- 2. Speaker
- 3. Tactile guides for the blinds
- 4. Microphone

### Function keys and status LEDs

*Note: when pressed, the keys light up and emit a "beep" (that can be deactivated using the procedure).*

*Note: the device initialisation procedure can last up to 2 minutes.*

Icon	Meaning
<b>Wi-Fi signal notification LED:</b>	
	When it is OFF, the Wi-Fi is disabled or works correctly.
	When it flashes red it indicates that the Wi-Fi is active but not connected to a network.
	When green and on steady, Classe100 X16E is exchanging data with the Door Entry CLASSE 100 APP (Entrance Panel call/Automatic Switching On/Call Home)
<b>Bell exclusion notification LED:</b>	
	When on red flashing, it means that the call ringtone is disabled,
<b>Programmable touch keys *</b>	
	Use these keys for intercom calls, activate Entrance Panels and Door Locks. The functions that can be completed depend on the configuration set by the installer (see <a href="#">Programming of the programmable keys</a> ).
<b>Door lock release touch key *</b>	
	During the connection with an Entrance Panel, use this key to release the door lock of that Entrance Panel, when idle, the same key releases the door lock of the associated Entrance Panel. When on white flashing, it means that the Professional Studio function is active.
<b>Entrance panel/scrolling activation touch key</b>	
	This key has two functions: It can be used to switch on the camera of the associated Entrance Panel, and to scroll through the connected cameras and/or entrance panels.

---

## Communication disabling key



Use this key to answer a call: when a call is answered, it switches on red; when the call is terminated it switches off.

---

## Staircase light touch key



Use this key to switch the Staircase Light on

---

## Communication enabling key



Use this key to answer a call: when a call is received, the key starts flashing, once the call is answered the light switches off.

---

*\* If the LEDs flash white when pressed, the "safe door lock" service is active and the key is deactivated.*

---

## Rear view

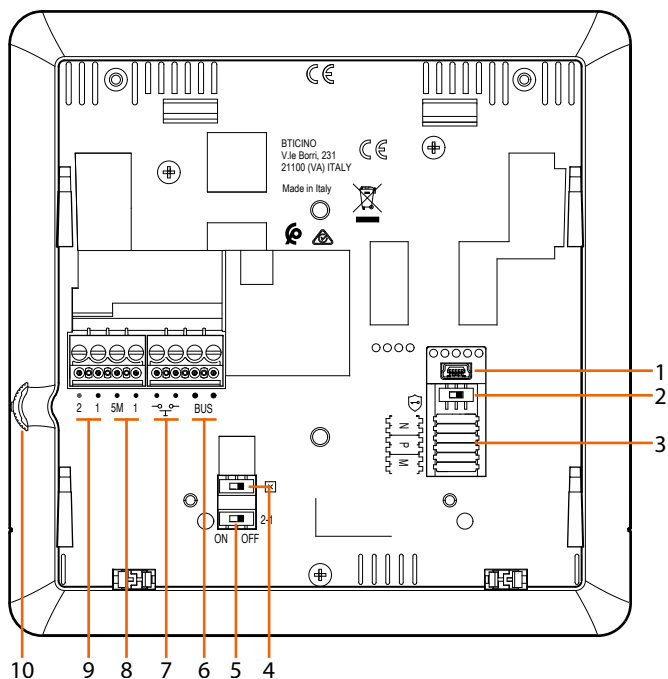

1. Mini USB socket for device Firmware update
2. OFF / ON micro-switch for "safe door lock" service  
ON=
- Note: to activate the service with device not powered**
3. Configurator socket
4. Line termination ON/OFF micro-switch
5. ON / OFF micro switch to enable the additional power supply
6. 2 WIRES SCS/BUS connection clamps
7. Clamps for the connection of an external call to the floor pushbutton
8. Additional bell connection clamps (5M – 1). The connection must be point - point on the clamps of the additional bells
9. Additional power supply clamps (2– 1)
10. Joystick for adjustments and programming



Caution: Installation, configuration, starting-up and maintenance must be performed exclusively by qualified personnel.



## Installation

 Caution: Installation, configuration, starting-up and maintenance must be performed exclusively by qualified personnel.

### Dimensional data and recommended installation heights

Recommended height, unless different regulations are specified.

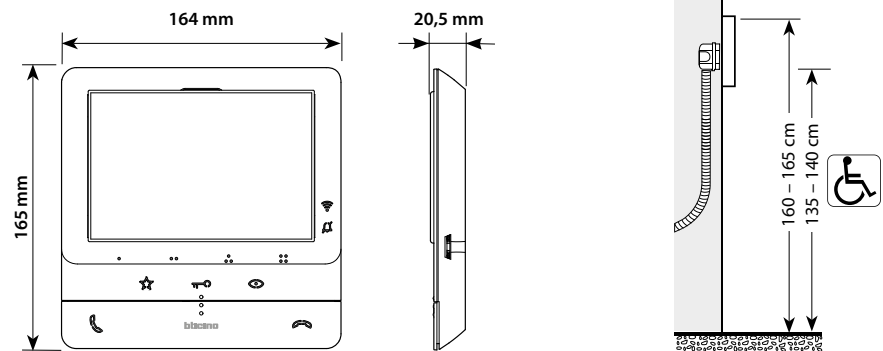

### Wall-mounted installation

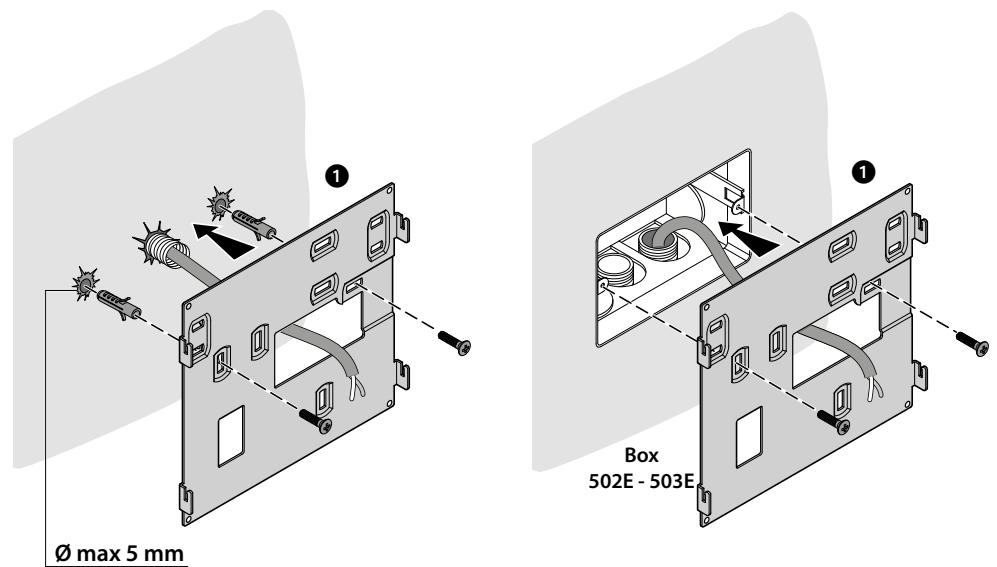

# Classe100 X16E

User and installation manual

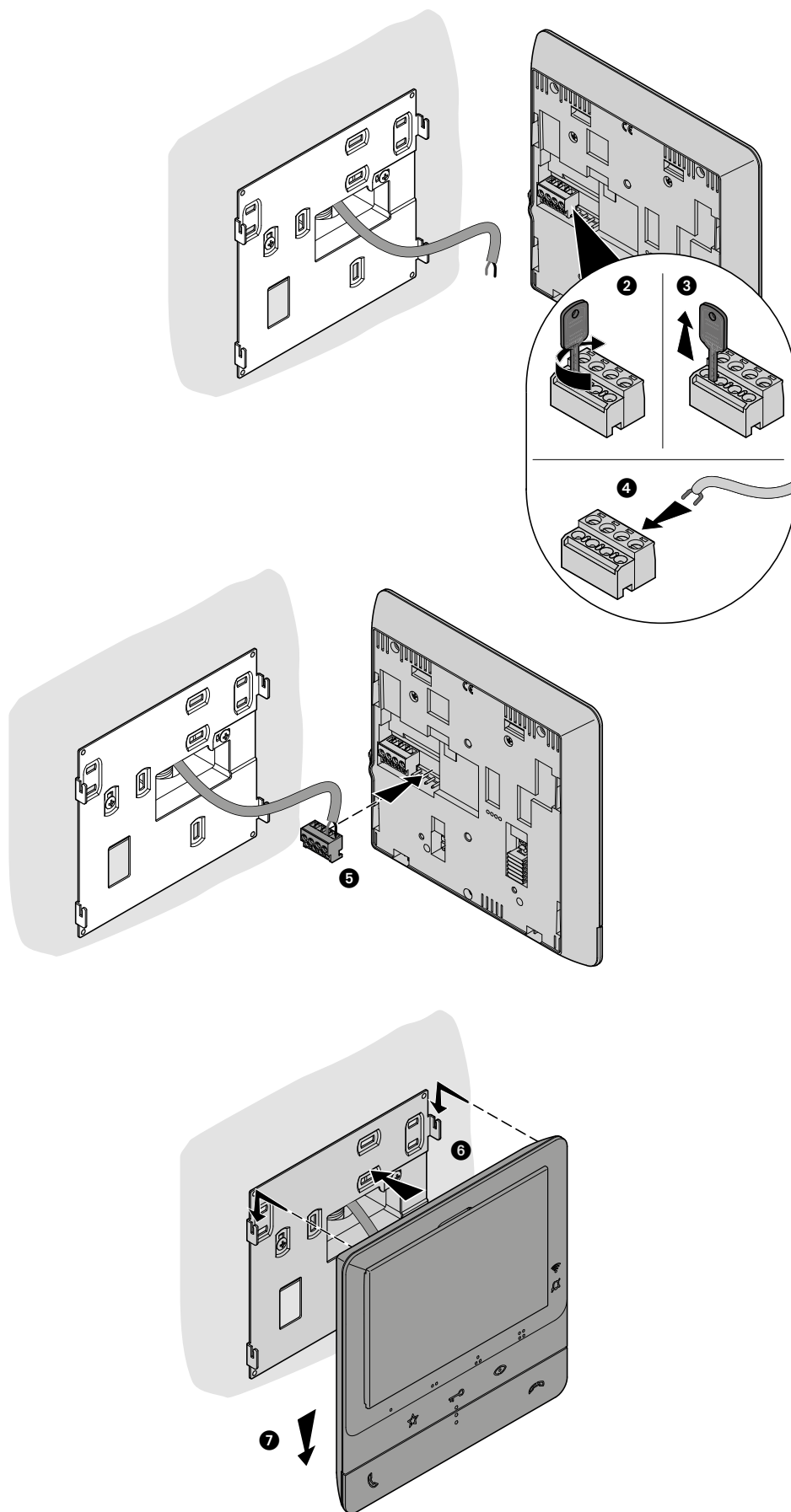

## Installation on the tabletop bases 344692 (optional)

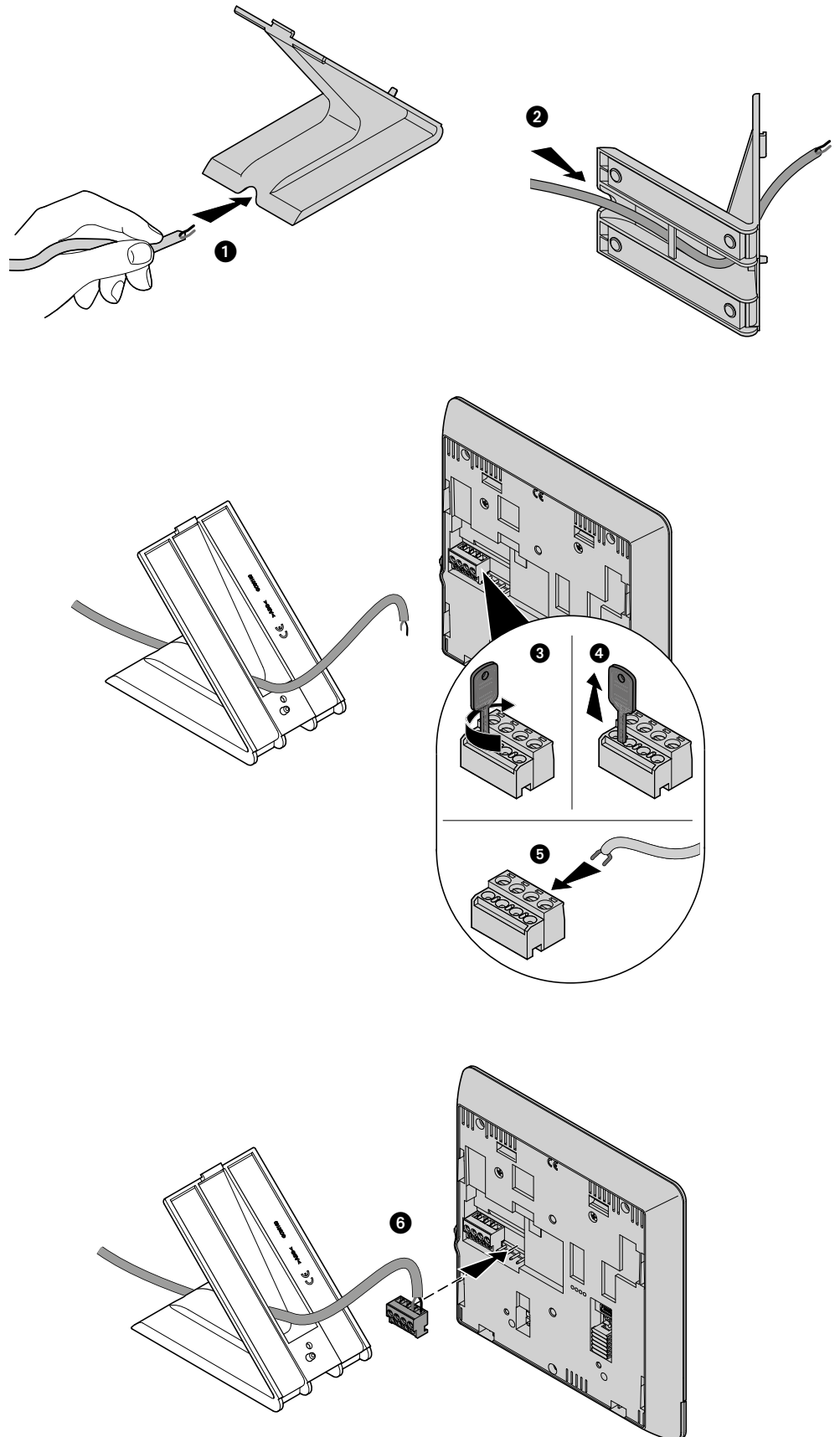

# Classe100 X16E

User and installation manual

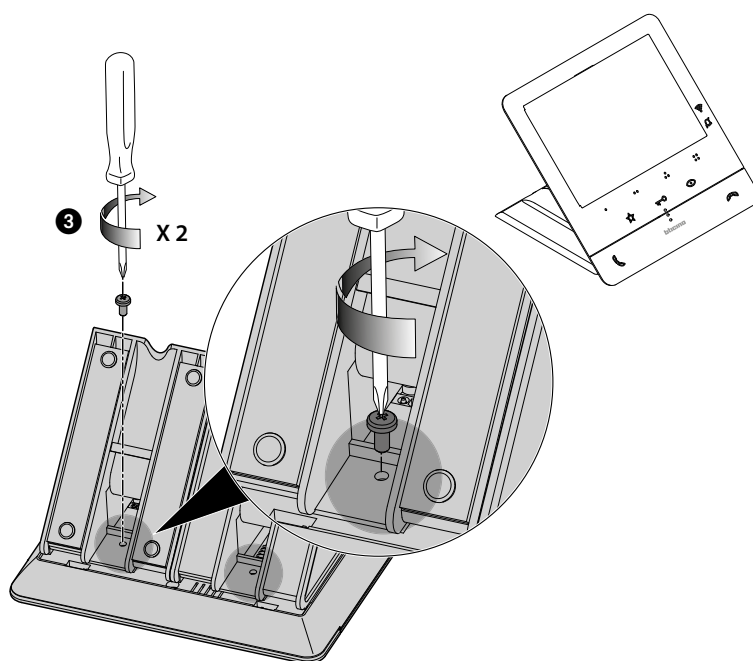
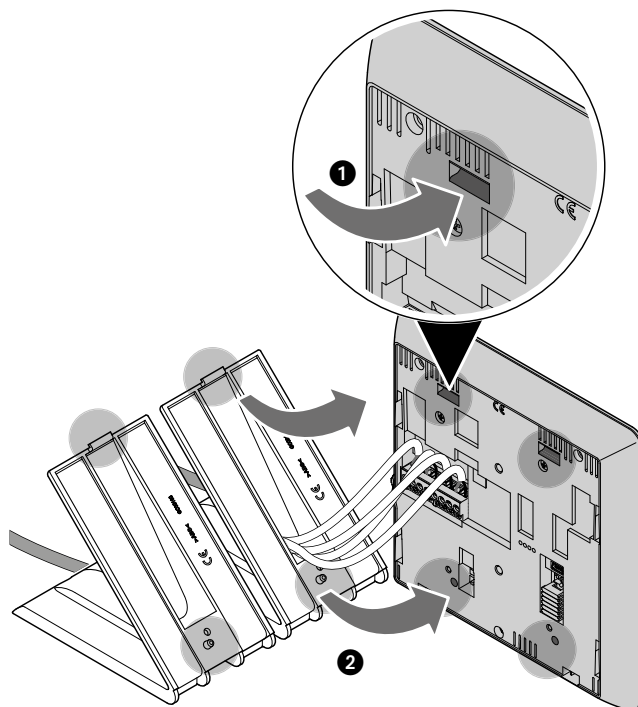

## Configuration

The device must be only physically configured.

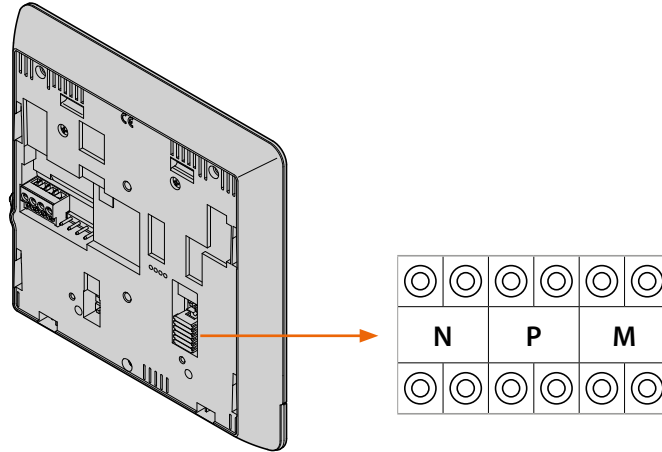

### N - Internal Unit number

The configurators connected to the N sockets of the device assign an identification number within the system to each video internal unit. The internal units must be configured in progressive order. Internal units with parallel connection (max 3 are allowed inside apartments without item 346850) must be configured using the same N configurator. In parallel with the main video internal unit, additional internal units, video internal units and/or ringtones may be installed.

### P – Entrance Panel association

The configurators connected to the P sockets of the device identify the associated EP, which is the first Entrance Panel that switches itself on when the pushbutton is pressed the first time, as well as which door lock is activated when pressing the door lock pushbutton while the video internal unit is idle.

### M – operating mode

The configurators connected to the M sockets of the device assign the operating modes to the 4 programmable keys (●, ●●, ●●●, ●●●●) based on the indications of the [Programming of the programmable keys](#) table.

They can also enable special functions that entail the activation of the professional studio and paging functions, individually or at the same time, in addition to the functions already programmed for the key.

### Example

SPECIAL FUNCTIONS				
	Key ●	Internal intercom	Professional Studio (Office)	Paging
CONFIGURATOR M	00	✓	✗	✗
	20	✓	✓	✗
	40	✓	✗	✓
	80	✓	✓	✓

## Programming of the programmable keys

Your Classe100 X16E is equipped with keys that perform specific functions depending on the configurator connected to the M socket.

MODE	KEY	SERVICE	NOTES
M = 00	●	<b>Internal intercom</b> It sends the call to all the handsets with the same address	
	● ●	<b>Activation of the EP</b> (configured with P+1) directly without call or activation of the actuator 346210 (configured with P+1 and MOD=9)	
	● ● ●	<b>EP door lock release</b> (configured with P+1), directly without call, or activation of the actuator 346210 (configured with P+1 and MOD=5), or activation of door lock actuators 346230 - 346260 (configured with P+1)	
	● ● ● ●	<b>EP door lock release</b> (configured with P+2), directly without call, or activation of the actuator 346210 (configured with P+2 and MOD=5), or activation of door lock actuators 346230 - 346260 (configured with P+2)	
M = 20		Key functions described above + <b>Professional studio</b>	
M = 40		Key functions described above + <b>Pager</b>	
M = 80		Key functions described above + <b>Professional studio + Pager</b>	
M = 01	●	<b>Internal intercom</b> It sends the call to all the handsets with the same address	
	● ●	<b>Intercom</b> inside the apartment, in systems with apartment interface 346850, or intercom among apartments in systems without apartment interface	
	● ● ●	<b>Activation of the EP</b> (configured with P+1) directly without call or activation of the actuator 346210 (configured with P+1 and MOD=9)	
	● ● ● ●	<b>EP door lock release</b> (configured with P+1), directly without call, or activation of the actuator 346210 (configured with P+1 and MOD=5), or activation of door lock actuators 346230 - 346260 (configured with P+1)	
M = 21		Key functions described above + <b>Professional studio</b>	
M = 41		Key functions described above + <b>Pager</b>	
M = 81		Key functions described above + <b>Professional studio + Pager</b>	

MODE	KEY	SERVICE	NOTES
M = 02	●	Intercom inside the apartment, in systems with apartment interface 346850, or intercom among apartments in systems without apartment interface	
	● ●	Intercom inside the apartment, in systems with apartment interface 346850, or intercom among apartments in systems without apartment interface	
	● ● ●	EP door lock release (configured with P+1), directly without call, or activation of the actuator 346210 (configured with P+1 and MOD=5), or activation of door lock actuators 346230 - 346260 (configured with P+1)	
	● ● ● ●	EP door lock release (configured with P+2), directly without call, or activation of the actuator 346210 (configured with P+2 and MOD=5), or activation of door lock actuators 346230 - 346260 (configured with P+2)	
M = 22		Key functions described above + <b>Professional studio</b>	
M = 42		Key functions described above + <b>Pager</b>	
M = 82		Key functions described above + <b>Professional studio + Pager</b>	

MODE	KEY	SERVICE	NOTES
M = 03	●	Intercom inside the apartment, in systems with apartment interface 346850, or intercom among apartments in systems without apartment interface	
	● ●	Intercom inside the apartment, in systems with apartment interface 346850, or intercom among apartments in systems without apartment interface	
	● ● ●	Intercom inside the apartment, in systems with apartment interface 346850, or intercom among apartments in systems without apartment interface	
	● ● ● ●	Intercom inside the apartment, in systems with apartment interface 346850, or intercom among apartments in systems without apartment interface	
M = 23		Key functions described above + Professional studio	
M = 43		Key functions described above + Pager	
M = 83		Key functions described above + Professional studio + Pager	



MODE	KEY	SERVICE	NOTES
M = 04	●	<b>Activation of the EP</b> (configured with P+1) directly without call or activation of the actuator 346210 (configured with P+1 and MOD=9)	
	● ●	<b>Intercom</b> inside the apartment, in systems with apartment interface 346850, or intercom among apartments in systems without apartment interface	
	● ● ●	<b>EP door lock release</b> (configured with P+1), directly without call, or activation of the actuator 346210 (configured with P+1 and MOD=5), or activation of door lock actuators 346230 - 346260 (configured with P+1)	
	● ● ● ●	<b>EP door lock release</b> (configured with P+2), directly without call, or activation of the actuator 346210 (configured with P+2 and MOD=5), or activation of door lock actuators 346230 - 346260 (configured with P+2)	
M = 24		Key functions described above + <b>Professional studio</b>	
M = 44		Key functions described above + <b>Pager</b>	
M = 84		Key functions described above + <b>Professional studio + Pager</b>	
M = 05	●	<b>EP door lock release</b> (configured with P+1), directly without call, or activation of the actuator 346210 (configured with P+1 and MOD=5), or activation of door lock actuators 346230 - 346260 (configured with P+1)	
	● ●	<b>EP door lock release</b> (configured with P+2), directly without call, or activation of the actuator 346210 (configured with P+2 and MOD=5), or activation of door lock actuators 346230 - 346260 (configured with P+2)	
	● ● ●	<b>EP door lock release</b> (configured with P+1), directly without call, or activation of the actuator 346210 (configured with P+1 and MOD=5), or activation of door lock actuators 346230 - 346260 (configured with P+1)	
	● ● ● ●	<b>EP door lock release</b> (configured with P+2), directly without call, or activation of the actuator 346210 (configured with P+2 and MOD=5), or activation of door lock actuators 346230 - 346260 (configured with P+2)	
M = 25		Key functions described above + <b>Professional studio</b>	
M = 45		Key functions described above + <b>Pager</b>	
M = 85		Key functions described above + <b>Professional studio + Pager</b>	

MODE	KEY	SERVICE	NOTES
M = 06		<p>“Preset intercom” function with intercommunicating call to the Handset configured with N=1.</p> <ul style="list-style-type: none"> <li>● From the system handsets it is possible to send an intercom call to the handset configured with N= 1. The indoor unit configured with N=1 can receive intercom calls, but is unable to send them</li> </ul>	
	● ●	<p><b>Internal intercom</b> It sends the call to all the handsets with the same address</p>	
	● ●	<p><b>EP door lock release</b> (configured with P+1), directly without call, or activation of the actuator 346210 (configured with P+1 and MOD=5), or activation of door lock actuators 346230 - 346260 (configured with P+1)</p>	
	● ●	<p><b>EP door lock release</b> (configured with P+2), directly without call, or activation of the actuator 346210 (configured with P+2 and MOD=5), or activation of door lock actuators 346230 - 346260 (configured with P+2)</p>	
M = 26		Key functions described above + <b>Professional studio</b>	
M = 46		Key functions described above + <b>Pager</b>	
M = 86		Key functions described above + <b>Professional studio + Pager</b>	

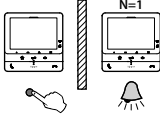
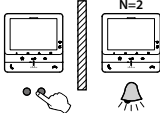
MODE	KEY	SERVICE	NOTES
M = 10		<p><b>General intercom</b>, it sends the call to all the apartment devices, in systems with apartment interface 346850, or intercom towards all the apartment devices in systems without apartment interface 346850;</p>	
	● ●	<p><b>Activation of the EP</b> (configured with P+1) directly without call or activation of the actuator 346210 (configured with P+1 and MOD=9)</p>	
	● ●	<p><b>EP door lock release</b> (configured with P+1), directly without call, or activation of the actuator 346210 (configured with P+1 and MOD=5), or activation of door lock actuators 346230 - 346260 (configured with P+1)</p>	
	● ●	<p><b>EP door lock release</b> (configured with P+2), directly without call, or activation of the actuator 346210 (configured with P+2 and MOD=5), or activation of door lock actuators 346230 - 346260 (configured with P+2)</p>	
M = 30		Key functions described above + <b>Professional studio</b>	
M = 40		Key functions described above + <b>Pager</b>	
M = 50		Key functions described above + <b>Professional studio + Pager</b>	
M = 12	●	<p><b>Intercom</b> among apartments X in systems with apartment interface 346850</p>	
	● ●	<p><b>Intercom</b> among apartments in systems with apartment interface 346850</p>	
	● ●	<p><b>EP door lock release</b> (configured with P+1), directly without call, or activation of the actuator 346210 (configured with P+1 and MOD=5), or activation of door lock actuators 346230 - 346260 (configured with P+1)</p>	
	● ●	<p><b>EP door lock release</b> (configured with P+2), directly without call, or activation of the actuator 346210 (configured with P+2 and MOD=5), or activation of door lock actuators 346230 - 346260 (configured with P+2)</p>	
M = 32		Key functions described above + <b>Professional studio</b>	
M = 52		Key functions described above + <b>Pager</b>	
M = 92		Key functions described above + <b>Professional studio + Pager</b>	

MODE	KEY	SERVICE	NOTES
M = 13	●	<b>Intercom</b> among apartments in systems with apartment interface 346850	
	● ●	<b>Intercom</b> among apartments in systems with apartment interface 346850	
	● ● ●	<b>Intercom</b> among apartments in systems with apartment interface 346850	
	● ● ● ●	<b>Intercom</b> among apartments in systems with apartment interface 346850	
M = 33		Key functions described above + <b>Professional studio</b>	
M = 53		Key functions described above + <b>Pager</b>	
M = 93		Key functions described above + <b>Professional studio + Pager</b>	

## Use from the device

*Note: the background and icons shown may differ from those on the device.*

### Functions

[Call another room or apartment \(intercom\)](#)

[NETATMO cameras](#)

[PE or cameras direct auto-switching on](#)

[Door lock release](#)

[Paging](#)

### Answer a call

Following an Entrance Panel call, the display shows the image being recorded and the communication key flashes.

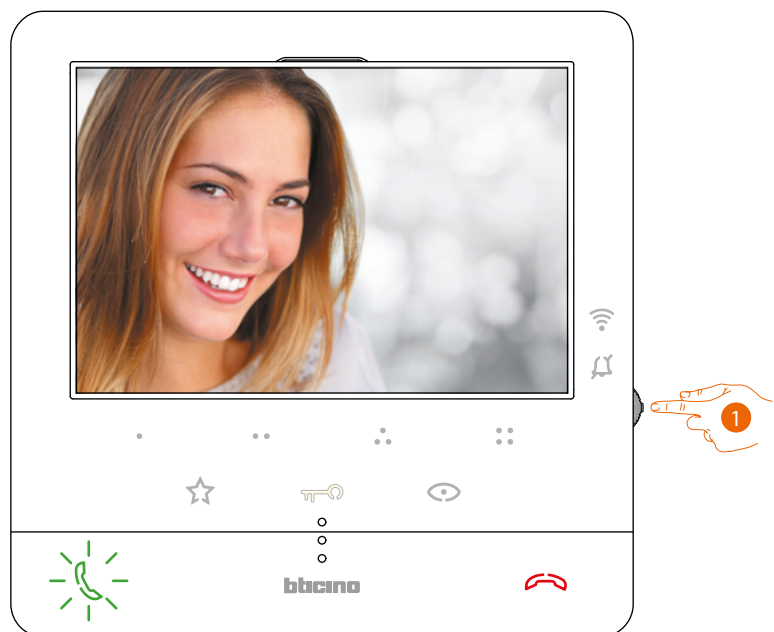

1. If necessary, during the call press the joystick to display the image sound/brightness/contrast/colour adjustment menu (see [Audio/video parameter adjustment](#)).

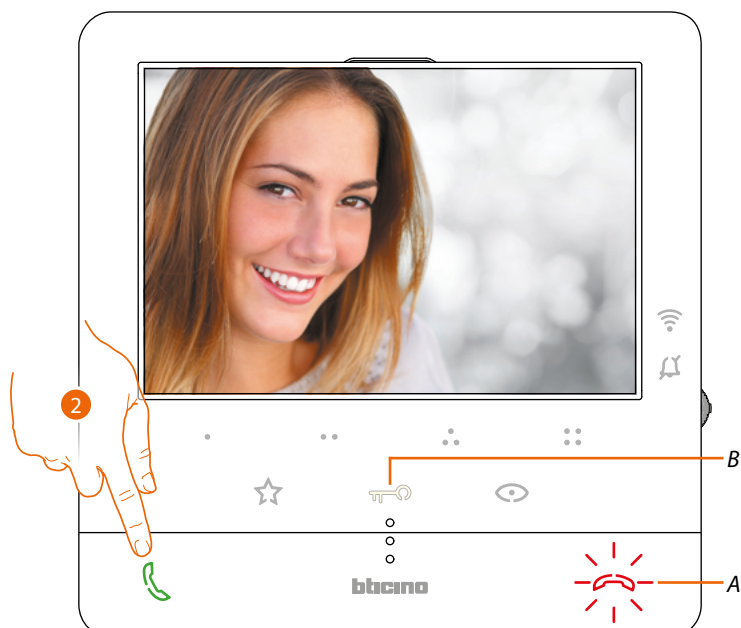

2. Touch to answer the call. The LED switches off. To end the call touch the (A) key, and to open the Entrance Panel door lock touch the (B) key.

## Call another room or apartment (intercom)

This section can be used to communicate with other video/audio Internal Units installed in your home, or in other apartments.

The programmable key to use for calling a certain Internal Unit is set by the installer (see [Programming of the programmable keys](#)).

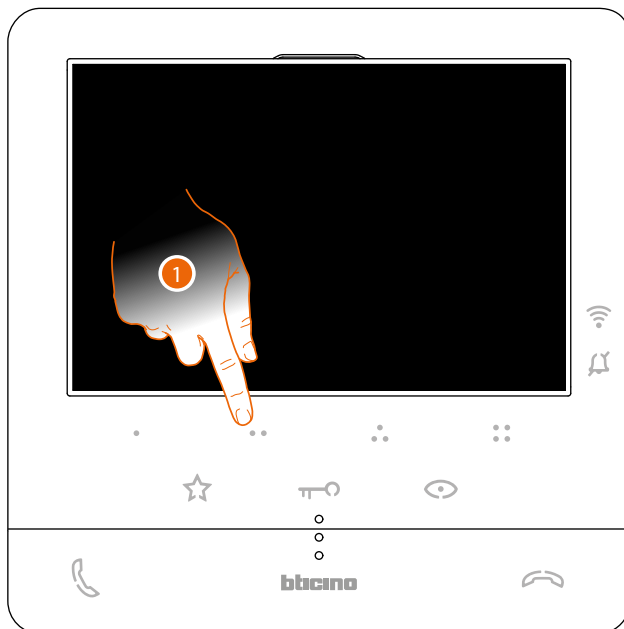

1. For example, touch programmable key ●● to activate the communication with the Internal Unit (e.g. configured as 2)

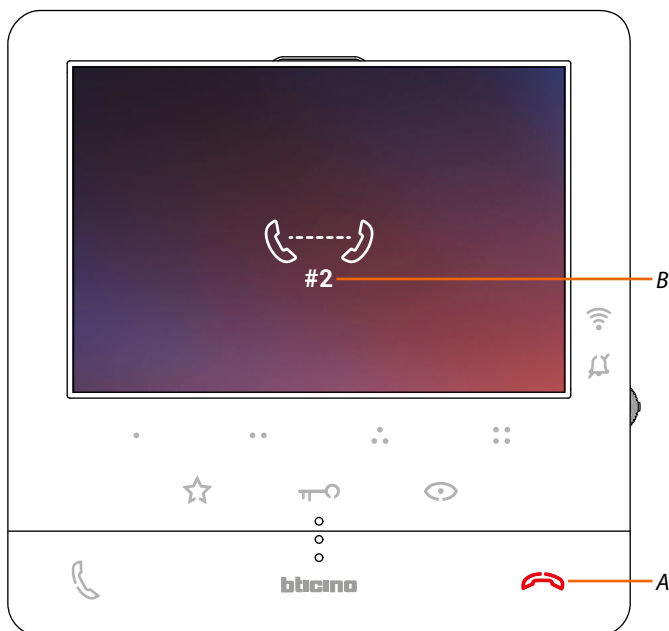

Key (A) lights up to indicate that the call is active.  
The display shows the ID of the Internal Unit called (B).



When the Internal Unit answers, the key starts to flash; communicate with the Internal Unit, or touch to close the call.

**Note:** if during the conversation a call is received from the Entrance Panel, the conversation is interrupted in order to answer the Entrance Panel call.

## PE or cameras direct auto-switching on

Using the automatic switch on key it is possible to display the main Entrance Panel camera and, if installed, scroll through other cameras/Entrance Panels.

Using the programmable keys it is also possible to directly display a camera or Entrance Panel. The programmable key to use for calling a certain Entrance Panel is set by the installer (see [Programming of the programmable keys](#)).

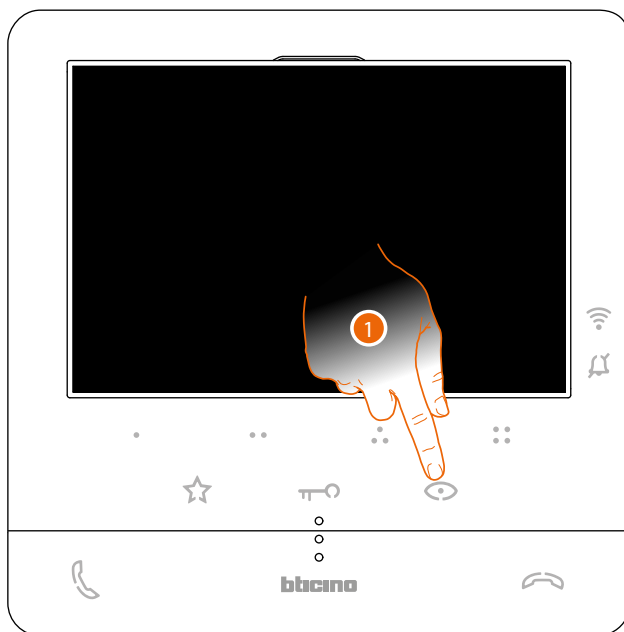

1. Touch to display the Entrance Panels or the cameras in your system.



2. If necessary, during the call press the joystick to display the image sound/brightness/contrast/colour adjustment menu (see [Audio/video parameter adjustment](#))

The (A) key flashes; if necessary, touch this key to enable audio communication.



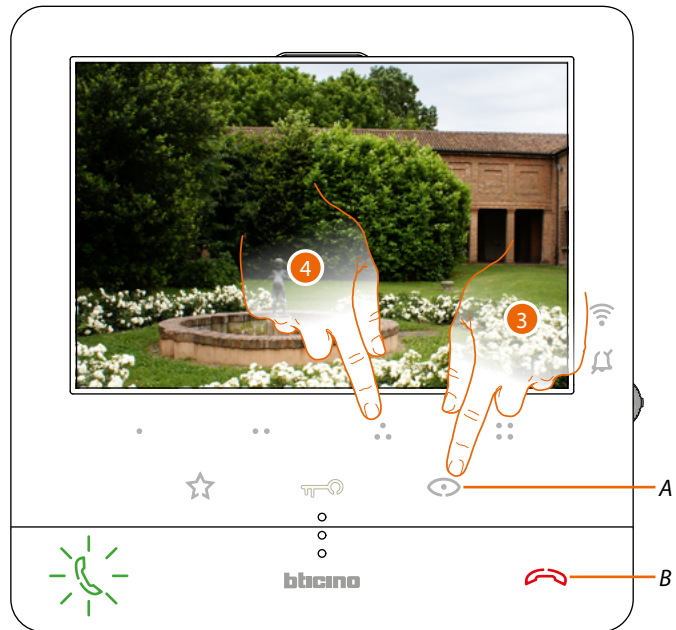

3. Touch to display another Entrance Panel or camera (using the scrolling service).  
When switching from one camera to the next, the (A) key lights up.  
To end camera display mode wait for the switching off time to elapse or press the (B) key

**Note:** switching from one camera to another is also possible without enabling the audio.

**Note:** NETATMO cameras are not included in the cycling function, and therefore will not be displayed. To display a Netatmo camera refer to the [Netatmo Cameras](#) section

4. To display a specific Entrance Panel, touch (for example) programmable key ☉



## NETATMO cameras

If your home includes NETATMO cameras, after associating them to the Door Entry CLASSE100X App you will be able to use them for video control directly from your CLASSE100 X16E.

If your NETATMO account is associated to several homes, each with one or more cameras, the full home list will be displayed.

You will therefore be able to see images of your seaside home from your Classe100 X16E installed in your main home

**Note:** it is possible to display the images from compatible NETATMO cameras only if the monitoring function is active on the NETATMO Security App.

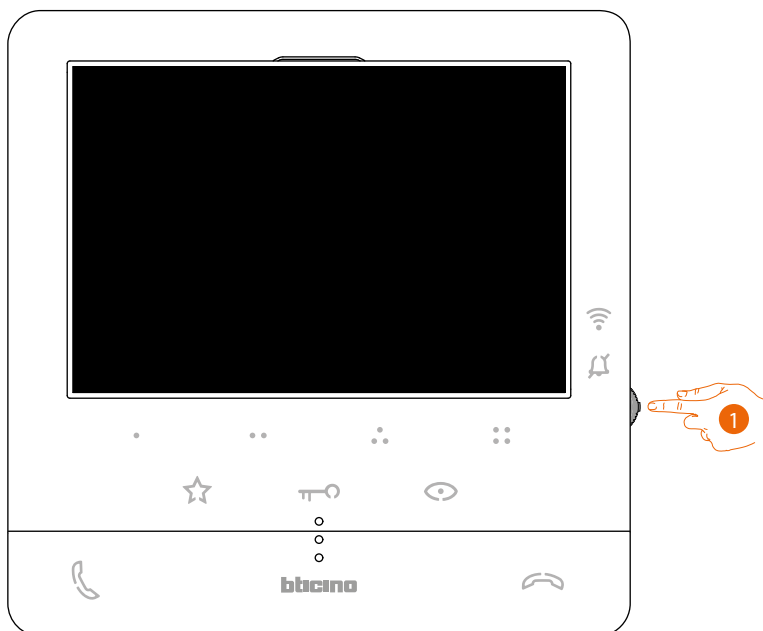

1. From stand-by press the joystick to activate the display.



2. Press to display the Netatmo cameras in your home.



3. Move the joystick up/down to select the camera that you want to display.

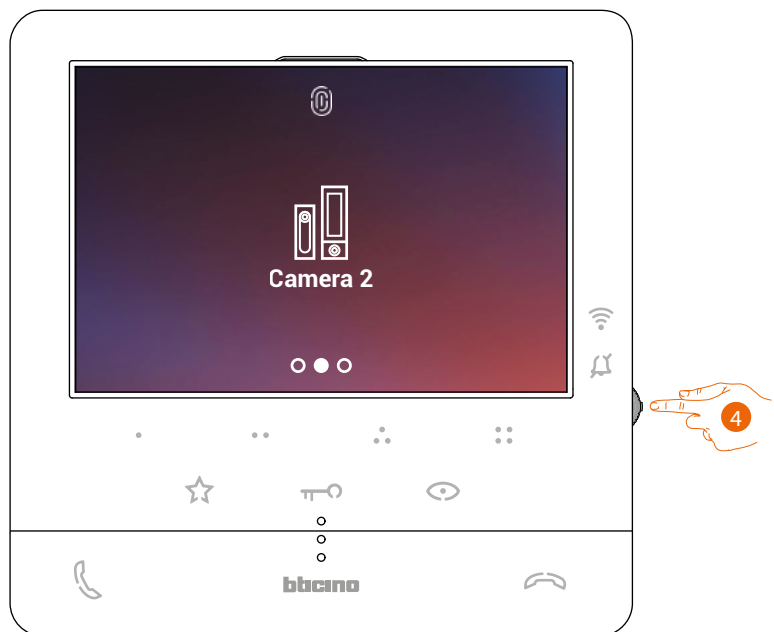

4. Touch to activate the desired camera, (the image is displayed for three minutes).

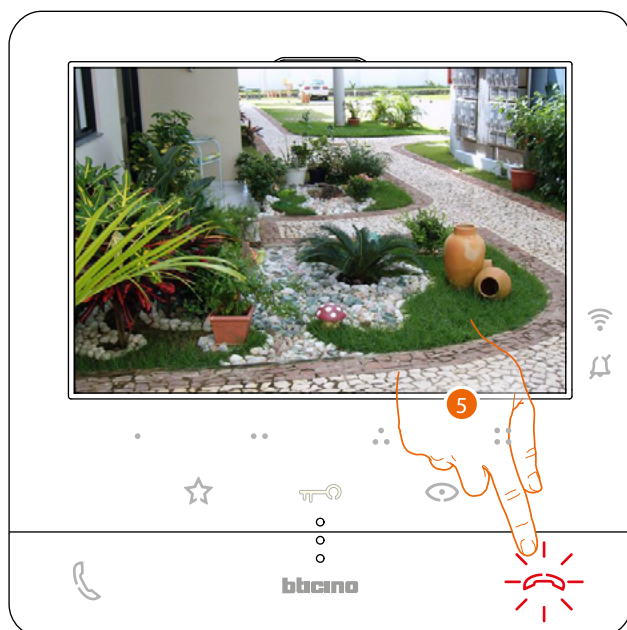

5. Touch to end.

## Door lock release

It is possible to open the main Entrance Panel door lock, using the door lock key. Using the programmable keys, it is also possible to open the system door locks. The programmable key to use for opening a certain door lock is set during the configuration by the installer (see [Programming of the programmable keys](#)).

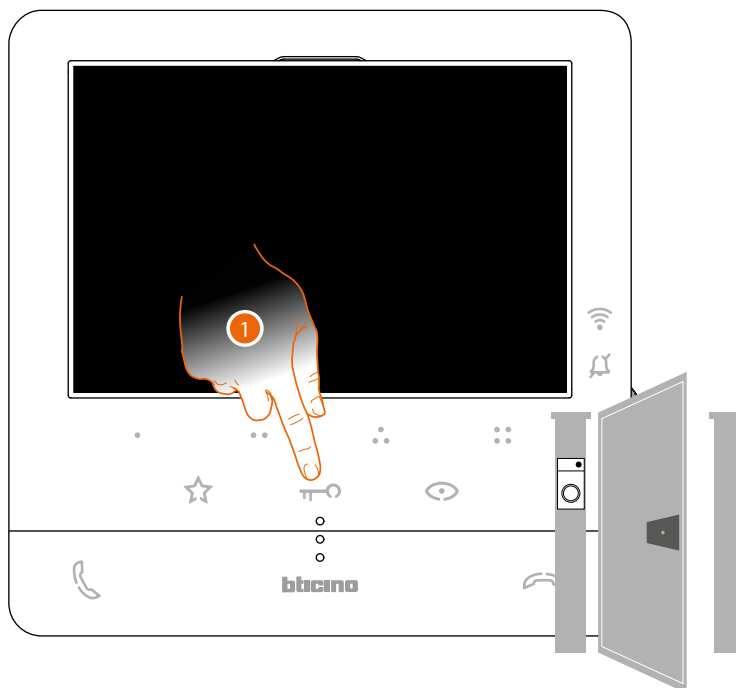

1. Touch to open the main Entrance Panel door lock.

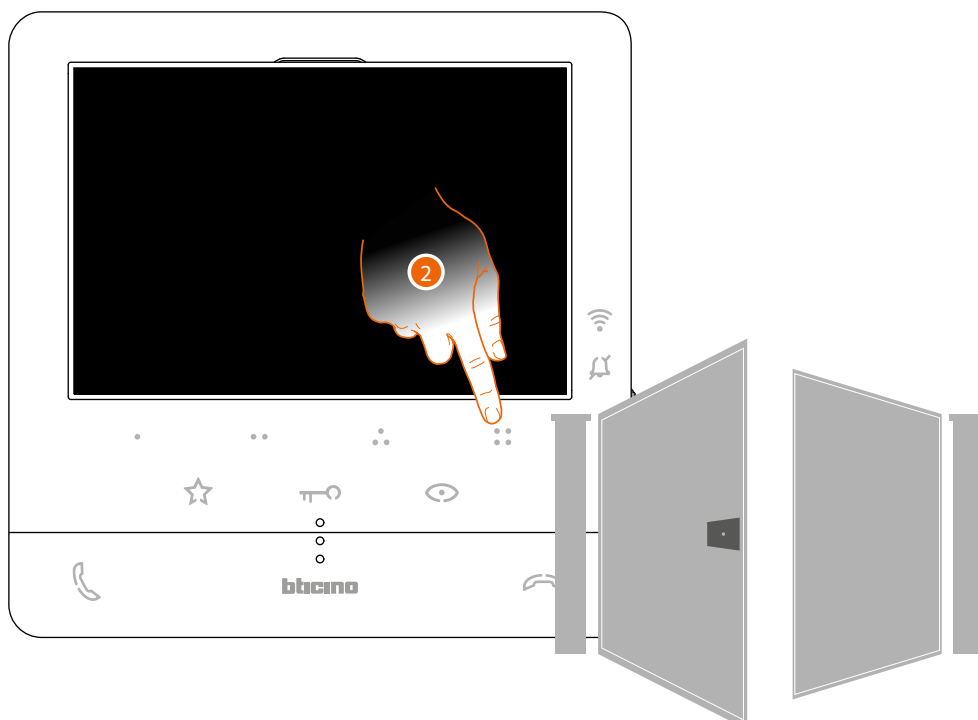

2. To open a specific door lock, touch (for example) programmable key .

## Paging

This function can be used to send voice messages using the microphone of the Classe100 X16E through the speakers of the sound system.

This function is enabled during the configuration by the installer (see [Programming of the programmable keys](#))

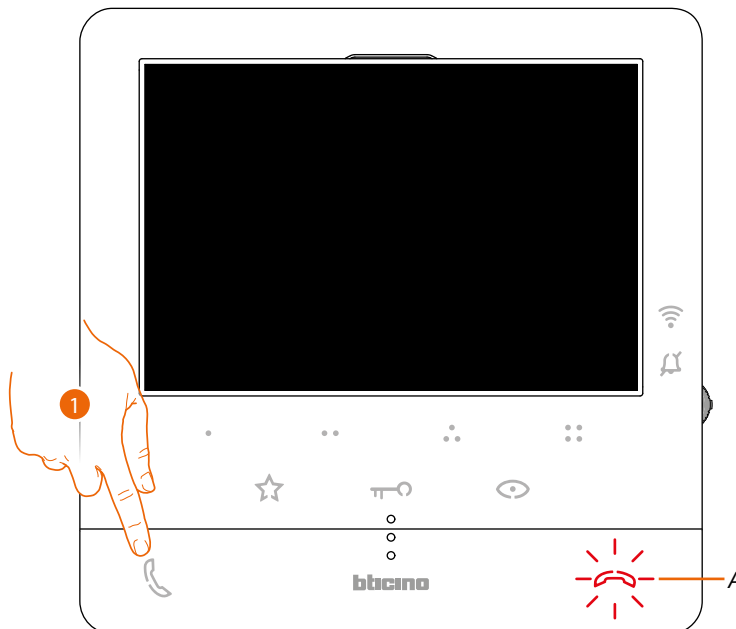

1. Touch to open the communication, the key (A) lights up to indicate that the call is active

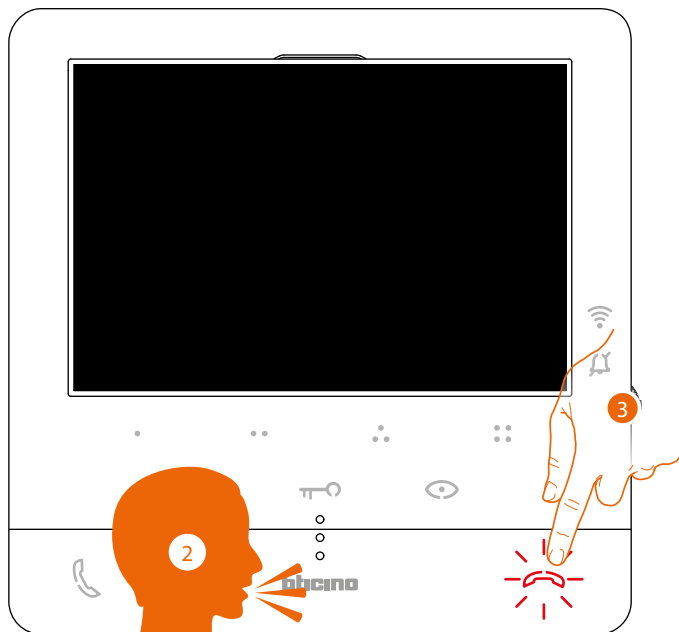

2. Play the message.
3. Touch to end the call.

## Services

With preset systems it is possible to also enjoy a range of services, such as:

[Inductive loop](#)

[Door status](#)

[Professional Studio \(Office\)](#)

[Safe door lock](#)

## Inductive loop

The INDUCTIVE LOOP service enables the device to be used by people wearing hearing aids with (T) selector.

Switch the acoustic device to the T position. To ensure correct magnetic coupling between the handset and the acoustic device, we recommend a position in front of the device, at a distance of 25-35 cm.

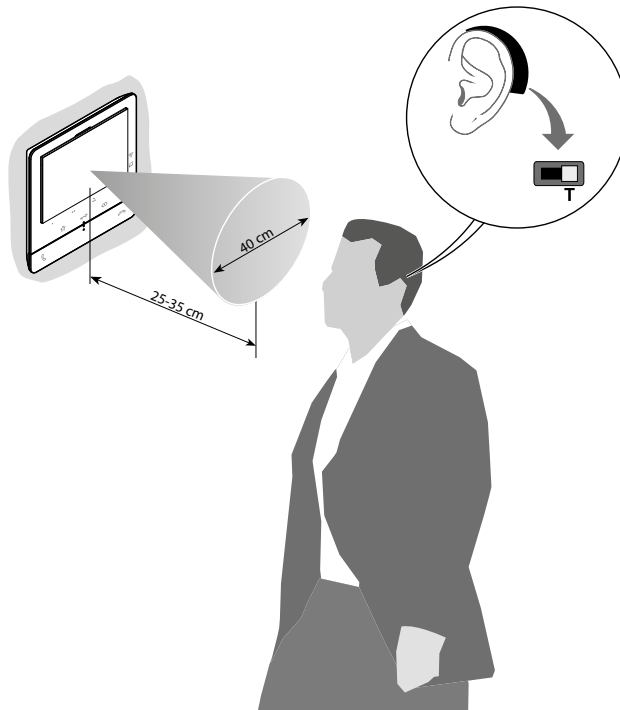

**Note:** the presence of metal and background noise generated by electric/electronic devices (e.g. computer) may compromise the performance and the quality of the coupling device.

## Door status

This service indicates through the door lock LED if the entrance door is open or closed. This service is enabled during the configuration by the installer (see [Programming of the programmable keys](#)).

**Note:** the service is active only if required by the system - accessory devices are required.

**Note:** It cannot be activated together with the Professional Studio (Office) service.

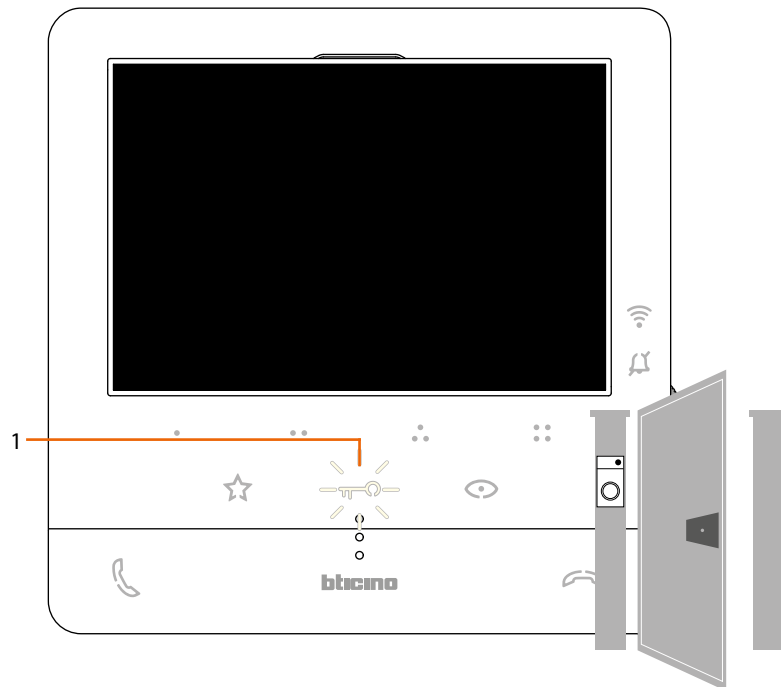

1. If the LED flashes, the entrance door is open.

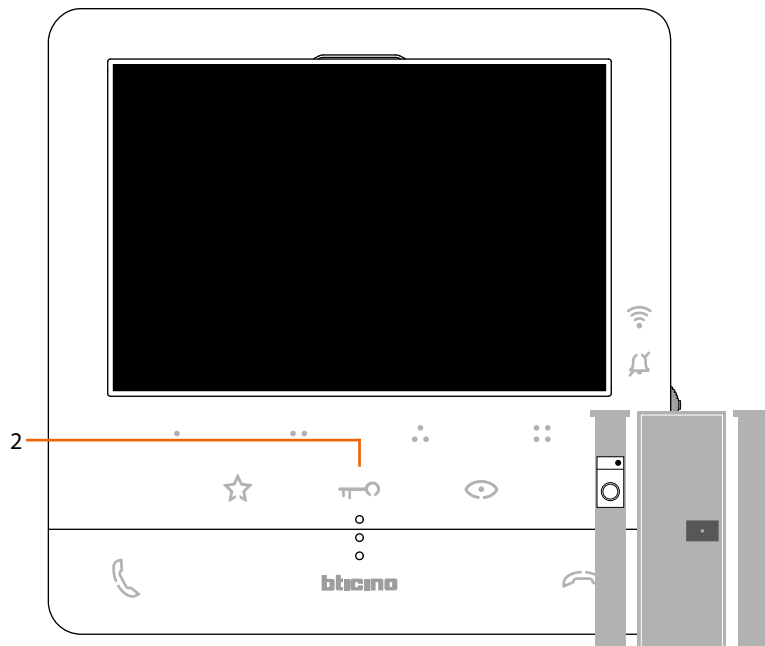

2. If the LED is off, the entrance door is closed.



## Professional Studio (Office)

When a call is received from the Entrance Panel, this service automatically opens the associated door lock without the need for pressing the door lock control key.

This service can be enabled during the configuration by the installer (see [Programming of the programmable keys](#)) and activated using the specific menu (see [enable/disable Professional Studio](#)).

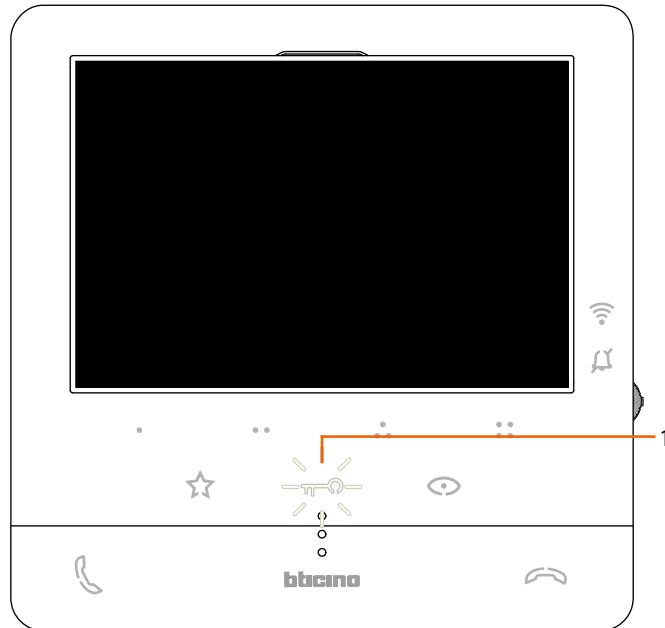

1. If this service is active, the Door Lock LED flashes.

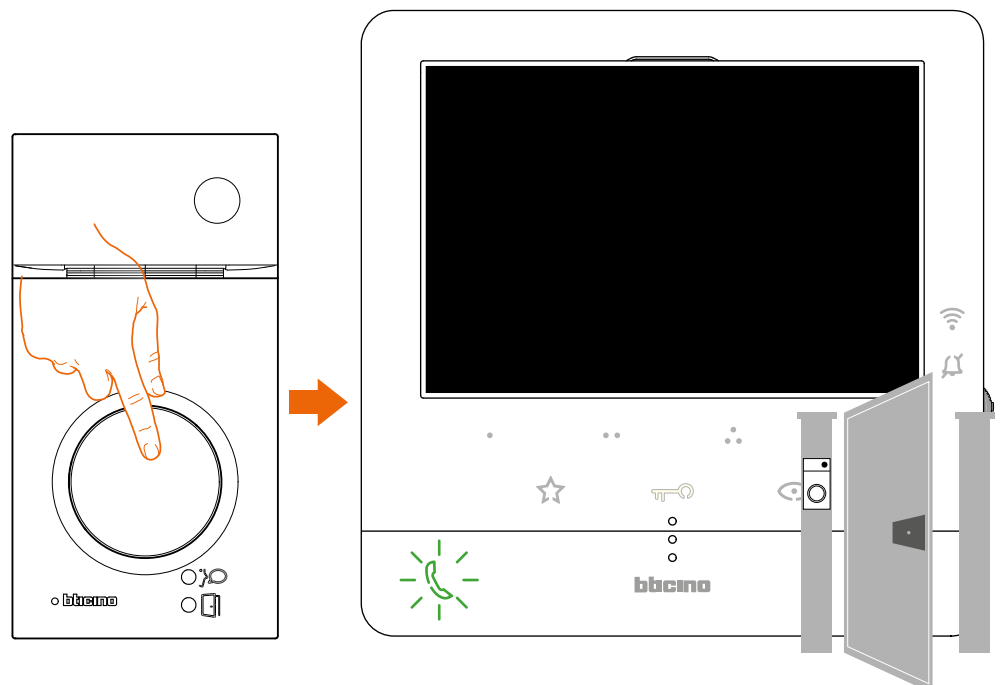

When a call is received from the Entrance Panel, the door lock is opened automatically.

## Safe door lock

When active, this service prevents the opening of the Entrance Panel door lock unless communication with the same is active.

Therefore, the opening of the door lock is only permitted when Entrance Panel and Internal Unit are in voice communication.

This service is enabled during the configuration by the installer (see [rear view](#)).

**Note:** the service cannot be activated together with the Professional Studio (Office) service

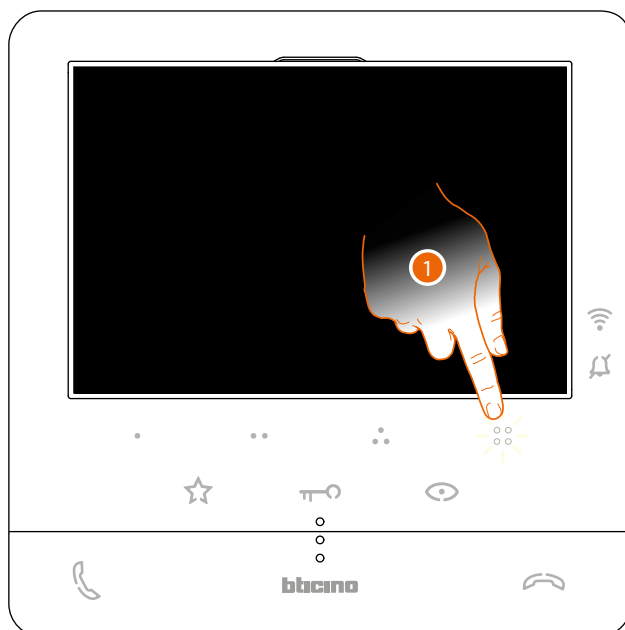

When this service is active, the door lock key or one of the programmable keys that activate the door lock are disabled.

1. If one of these controls is pressed, the corresponding LED flashes, but the command is not executed.





## Device adjustments and settings

Using the joystick it is possible to perform adjustments (Adjustments and/or Parameter Adjustment menu during Audio/Video connection) and settings (Settings menu)

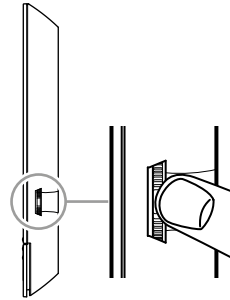
### Use of the joystick

You must use the joystick on the side of the device to navigate on the menu and select the settings.

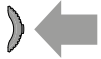

SYMBOL	ACTIONS TO BE PERFORMED	SERVICE
	Press	Confirm/access the Adjustments mode
 > 5 sec	Press and hold down for more than 5 sec	Access the Settings mode
		
	Move the joystick up (when released, it returns to central position)	Previous page/increase level
	Move the joystick down (when released, it returns to central position)	Next page/decrease level

## Wi-Fi adjustments and settings

### Wi-Fi adjustments and settings menu

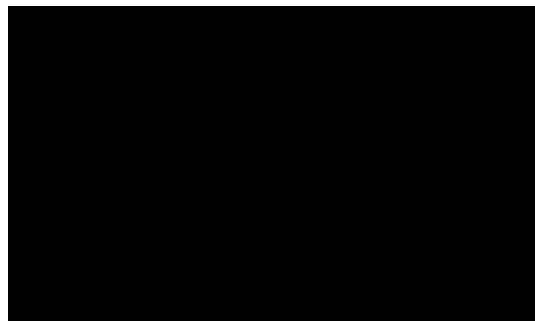

From stand-by press the joystick to activate the display

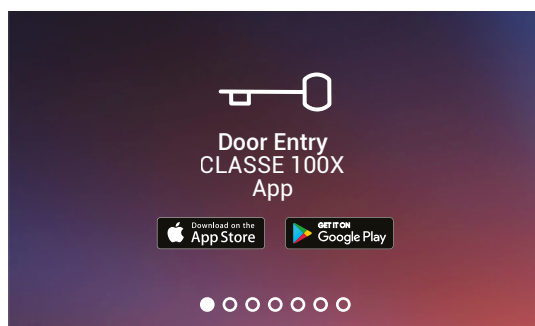

Move the joystick up/down to select the page among:

You can download the Door Entry CLASSE100X App from the Stores.

The page disappears after the first association with the App:

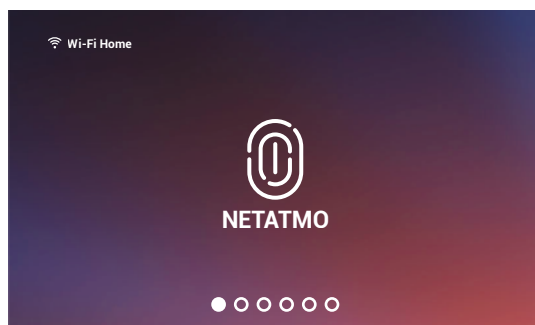

Display [the NETATMO cameras](#)

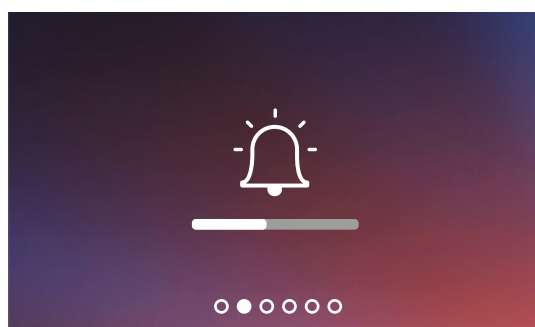

[Adjust the ringtone volume.](#)

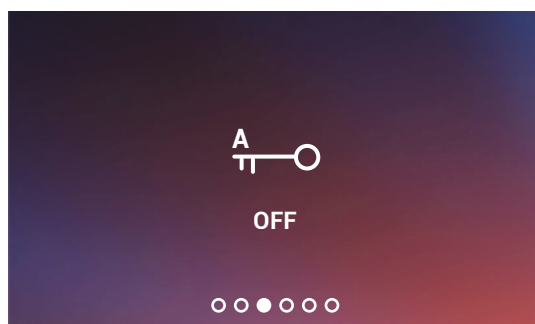

[Activate/deactivate the Professional studio-Office function.](#)

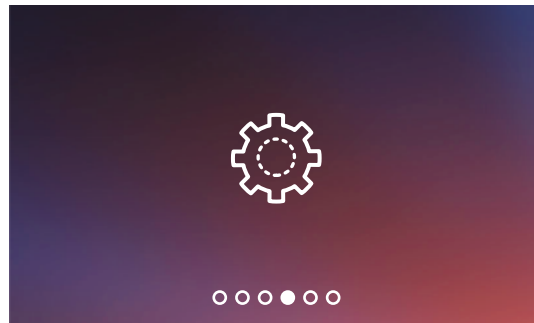

[Wi-Fi settings page](#), where it is possible to enable/disable/reset the Wi-Fi, perform the first association to the app and reset the device.

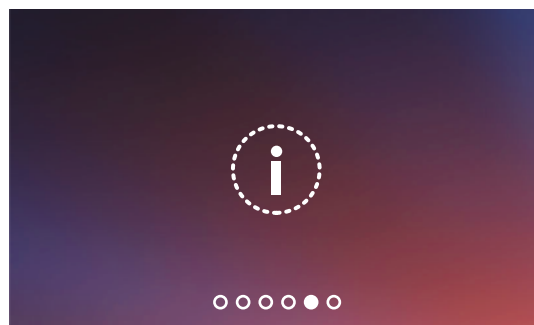

[Device info.](#)

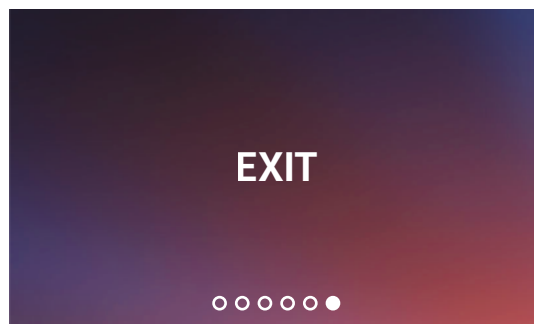

Exit the menu.

## Ringtone volume adjustment

From stand-by press the joystick to activate the display and select the corresponding page.

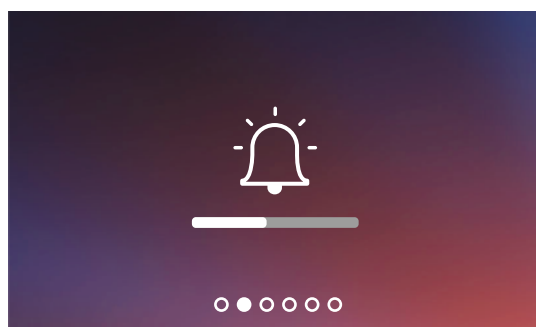

- 1 Press the joystick to adjust the volume.  
The ringtone is played at the set volume level.

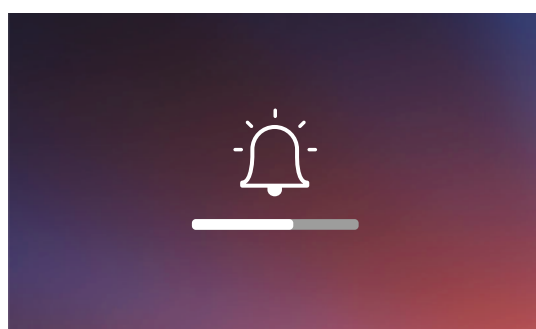

- 2 Move the joystick up/down to select the volume level (1 – 8).

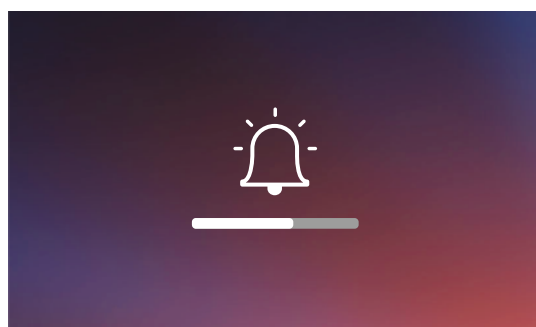

- 3 Press the joystick to confirm the setting or wait for the timeout.

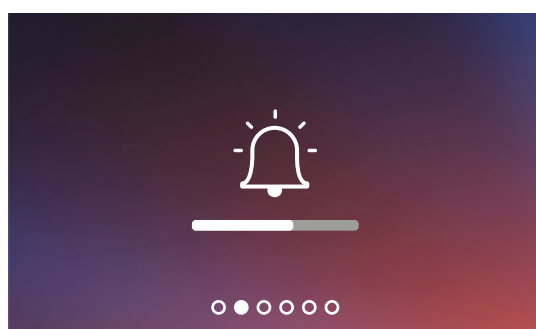

- 4 Move the joystick up/down to select another setting or the last page to exit.



The minimum level corresponds to the exclusion of the ringtone. The corresponding LED flashes red.

## Activate/deactivate the professional studio-office function

When a call is received from the entrance panel, this function automatically activates the associated door lock without the need for pressing the door lock control key.

To enable this function, Classe100 X16E must be configured as shown in the [Programming of the programmable keys](#).

Moreover, the function must be enabled as follows:

From stand-by press the joystick to activate the display and select the corresponding page

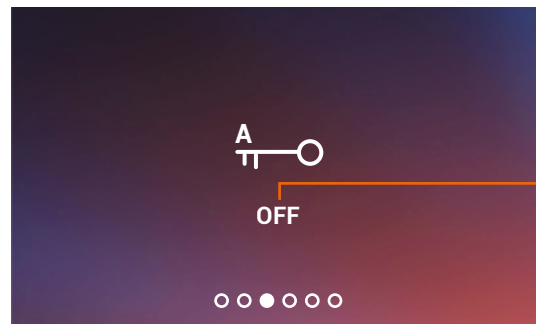

A Function status notification (ON = enabled, OFF = disabled).

1 Press the joystick to change mode.

**Note:** it cannot be activated together with the Safe Door Lock and the Door Status function.

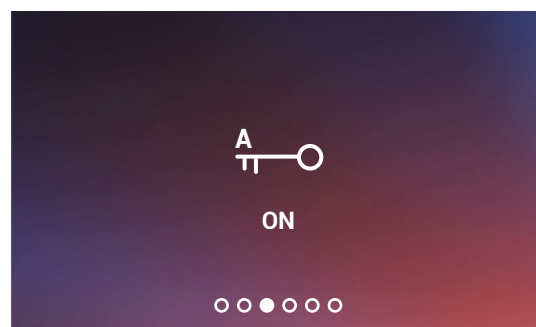

2 Move the joystick up/down to select another setting or the last page to exit.

## WI-FI settings

From stand-by press the joystick to activate the display and select the corresponding page.

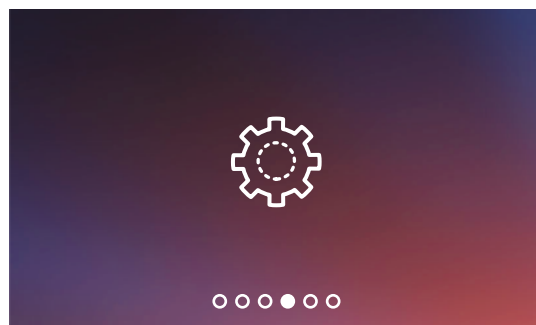

Press the joystick to select the page of interest.

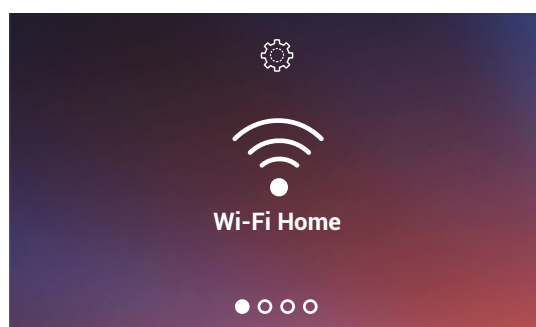

[Enable/disable the Wi-Fi Network](#)

Move the joystick up/down to select the page among



**Note:** to connect the device to the Wi-Fi network and to the app, you must first associate the Classe100 X16E to the Door Entry CLASSE100X app

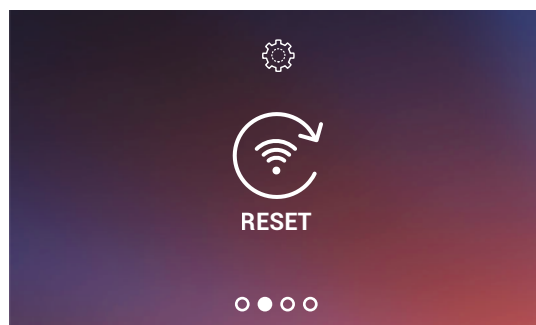

[Reset the Wi-Fi network](#)



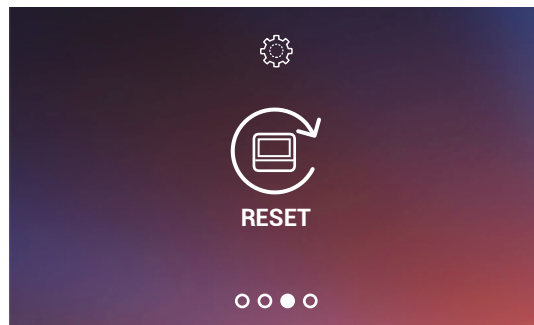

**Device reset**

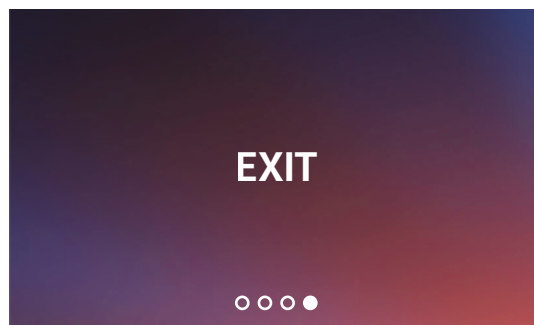

Exit the menu.

### Enable/disable the Wi-Fi Network

In this page you can display the Wi-Fi network to which the device is connected and if necessary disable the connection.

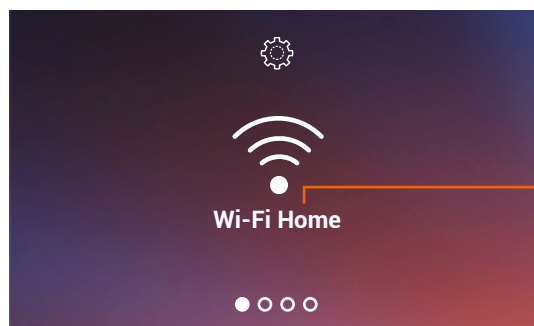

- A Wi-Fi network name to which the device is connected;
1. press the joystick to disable the Wi-Fi network.

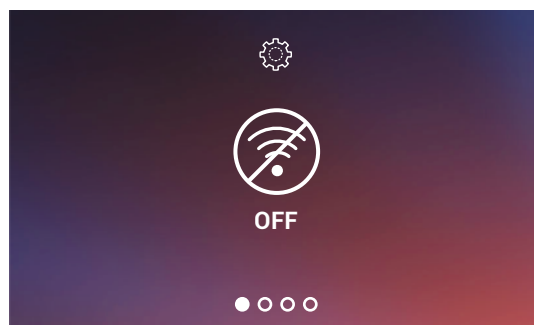

Now the Wi-Fi network is no longer active, but the device is still authenticated to it.

**Note:** to disconnect the Wi-Fi network from the device, the device must be **reset** following the appropriate procedure.

## Reset the Wi-Fi network

In this section it is possible to change the Wi-Fi network to which the device is connected, or the network password.

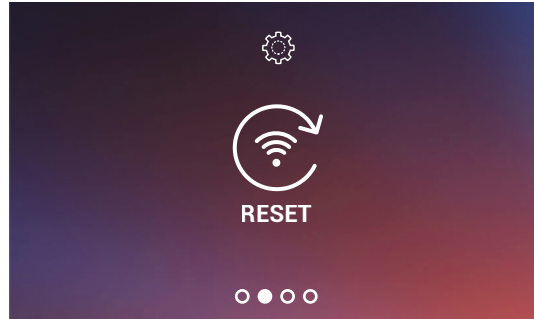

1. Press the joystick to reset the Wi-Fi network.

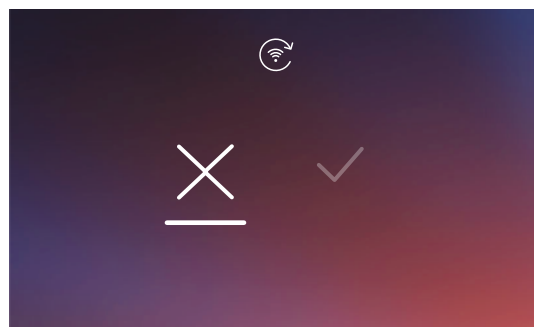

2. Move the joystick down to select the confirmation icon.

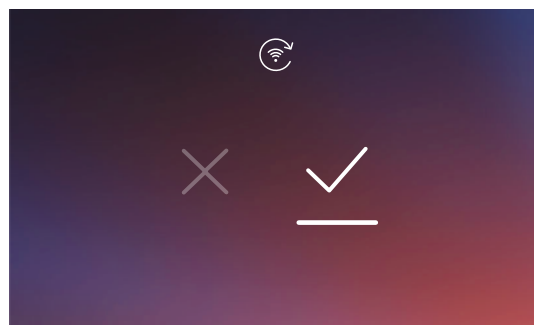

3. Press the joystick to confirm.

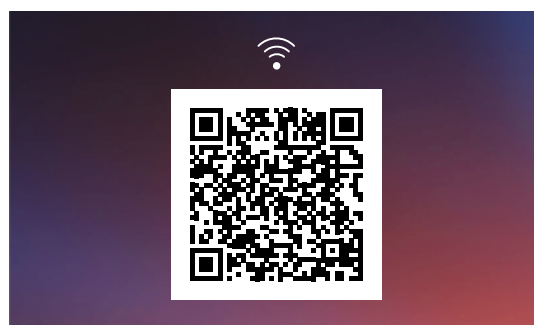

Now the device is no longer connected to the Wi-Fi network.  
To reconnect the device to the same network or to a new one, you must complete the guided procedure from the Door Entry CLASSE100X app in the [Settings/Set the video internal unit Wi-Fi](#).

**Note:** if the procedure is not completed, after a few seconds the connection is restored.

## Device reset

This page can be used to reset the device.

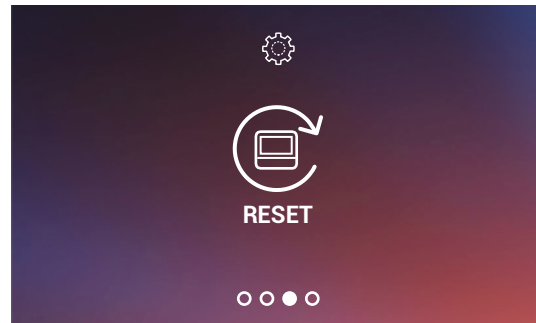

1. Press the joystick to reset the device.

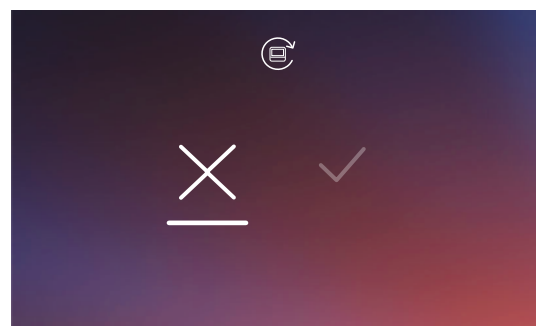

2. Move the joystick down to select the confirmation icon.

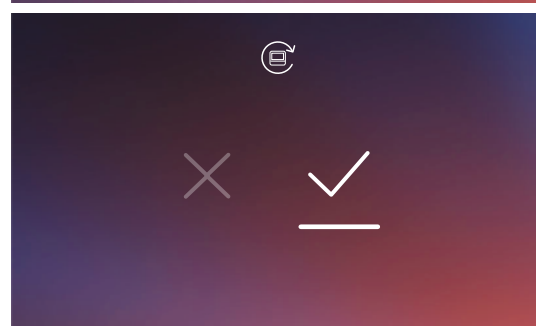

3. Press the joystick to confirm.



**Note:** all the data concerning associated accounts and the Wi-Fi connection will be deleted.

**Note:** this procedure resets the device, to complete the system reset, refer to the [Settings/Reset video internal unit section](#).

## Device info

From stand-by press the joystick to activate the display and select the corresponding page.

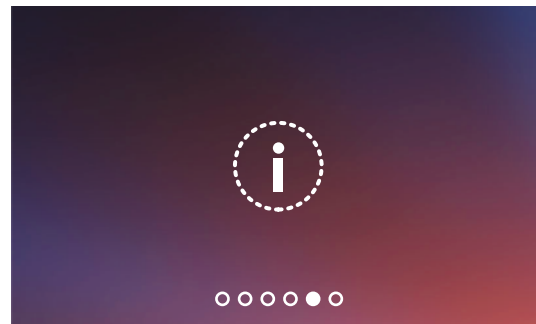

1. Press the joystick to display the information.

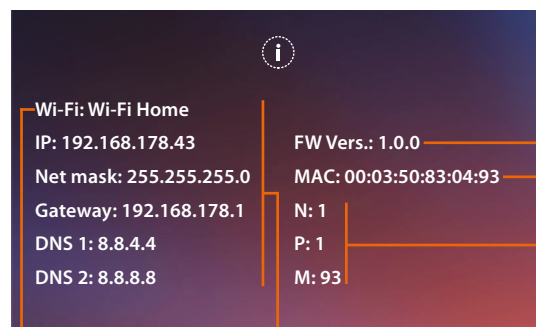

A

B

- A Wi-Fi network name to which the Classe100 X16E is connected.
- B Network parameters.
- C Firmware version.
- D MAC address.
- E E Configurator value (see [Configuration](#)).

### Audio/video parameter adjustments (function not available for the NETATMO cameras)

During a connection to an Internal Unit, Entrance Panel or when using the Call home function with Door Entry CLASSE100X app, it is possible to modify the speaker volume and, in case of video connection, the colour, contrast and brightness of the image.







- 1 During a connection press the joystick to modify the parameters



The page shows the type of parameter (A) and the set level (B)

- 2 Move the joystick up/down to select the type of parameter for which you want to modify the value (see the following table)

ICON	TYPE OF PARAMETER
	Speaker volume (Parameter that can be adjusted only with active audio)
	Image brightness
	Image contrast
	Image colour

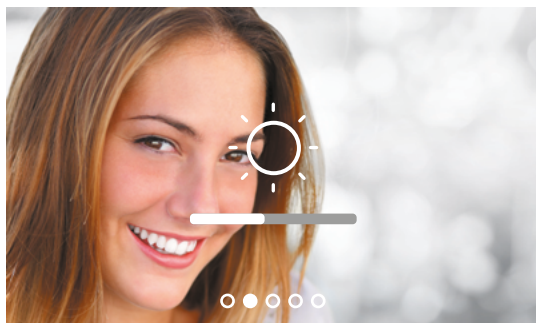

3 Press the joystick to modify the level.

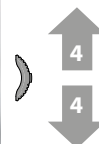
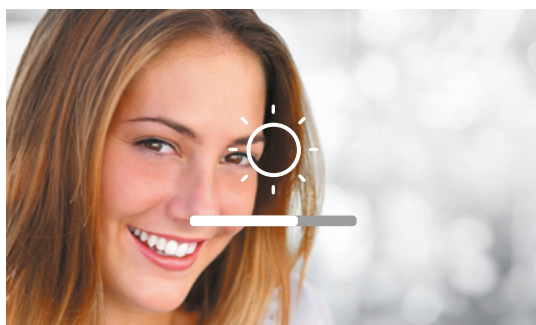

4 Move the joystick up/down to select the desired level.

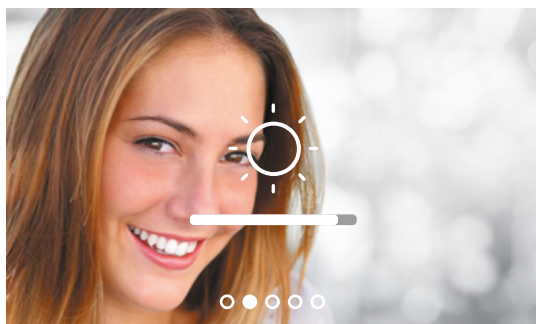

5 Press the joystick to confirm or wait for the timeout.

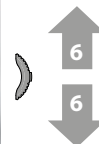
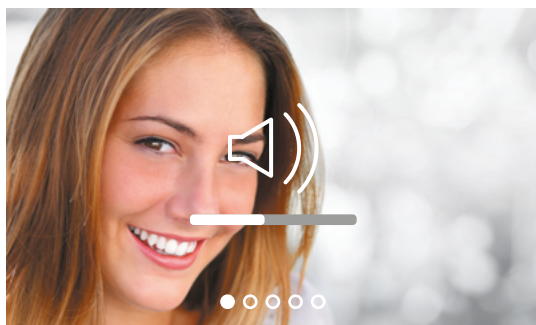

6 Move the joystick up/down to select another parameter or the last page to exit.

## Settings

### Settings menu

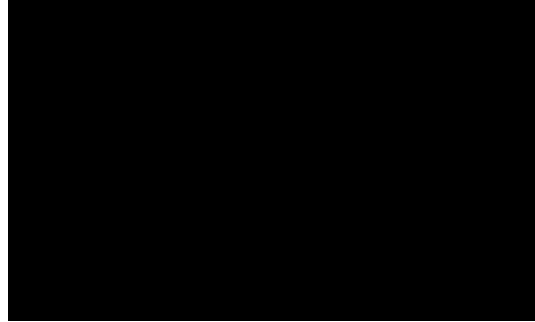

From stand-by, press and hold down the joystick for **about 5 seconds** to activate the display and access the Settings menu

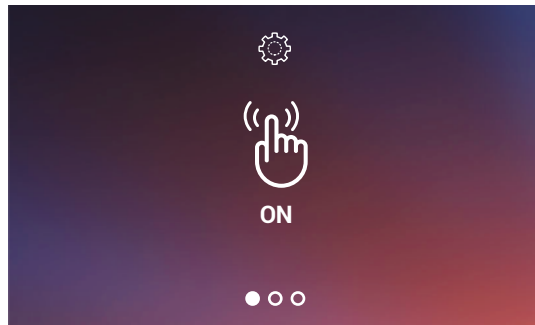

Move the joystick up/down to select the page among:

[Enable/disable the key sound](#)

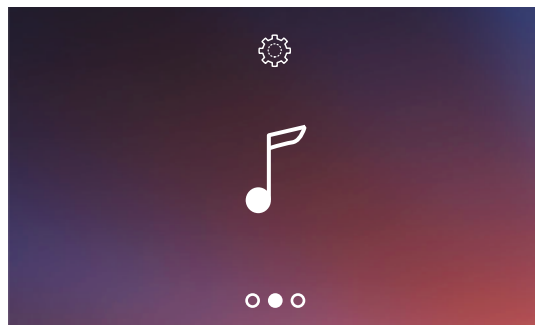

[Associate a ringtone to an event](#)

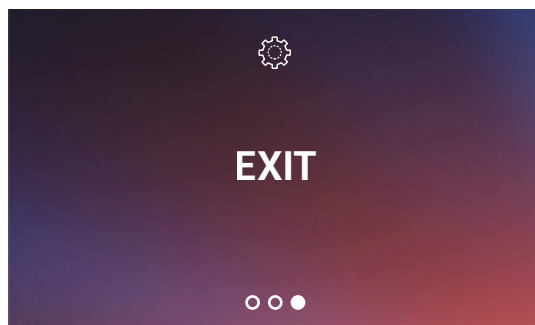

Exit the menu

### Enable/disable the key sound

This function enables/disables the BEEP when the keys are pressed. The function is disabled by default, to enable it follow the procedure below:

From stand-by, **press and hold down the joystick for 5 seconds** to access the advanced menu and select the corresponding page.

A Function status notification (ON = enabled, OFF = disabled)

- 1 Press the joystick to change mode.
- 2 Move the joystick up/down to select another setting or the last page to exit.

### Associate a ringtone to an event (call)





This page can be used to modify the ringtones associated to the different types of call. The ringtones played for calls from EP configured with S=2 and S=3 are set by default and cannot be changed (check the Entrance Panel configuration with your installer).

From stand-by **press and hold down the joystick for 5 seconds** to access the advanced menu and select the corresponding page.

- 1 Press the joystick to associate the first event.
- 2 Move the joystick up/down to select the type of call for which you want to set the ringtone (see the following table)

The page shows the type of call (A) and the current ringtone number (B).



ICON	TYPE OF CALL
	Selection of the call ringtone from the MAIN ENTRANCE PANEL
	Selection of the call ringtone from the SECONDARY ENTRANCE PANEL
	FLOOR CALL ringtone selection
	INTERCOM CALL ringtone selection
	EXTERNAL INTERCOM CALL ringtone selection (interface 346850 only)

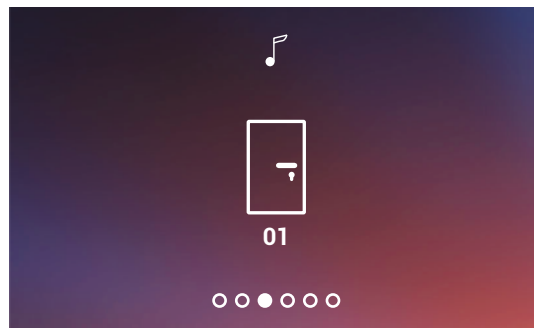

3 Press the joystick to continue

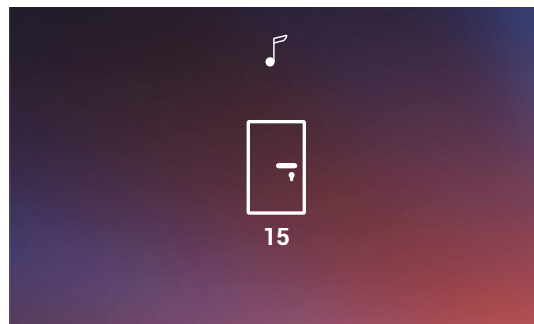

4 Move the joystick up/down to select the ringtone to be associated (the ringtone is played)

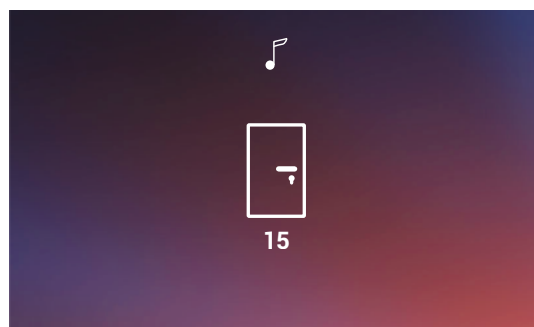

5 Press the joystick to confirm or wait for the timeout

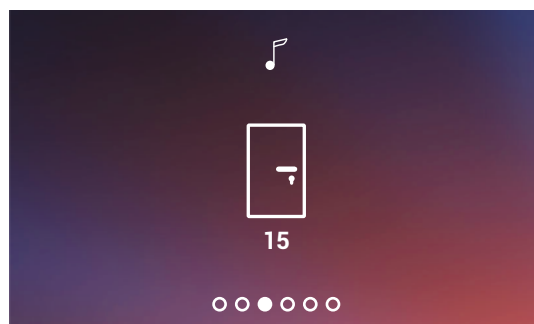

6 Move the joystick up/down to select another call or the last page to exit

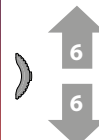

## Use with the Door entry Classe100X App

### Introduction

You can interact with your Classe100 X16E using the free Door Entry CLASSE100X app. After registering and authenticating, you must make the association with the device; at this point you can

- answer a video door entry call from the Entrance Panel;
- Call home (call your Classe100 X16E);
- display the images from the entrance panels and cameras;
- open the door lock of the Entrance Panels;
- update the firmware of your Classe100 X16E.



To download the Door Entry CLASSE100X app (for iOS devices from App Store, for Android devices from Play Store), scan the QR code with your smartphone:

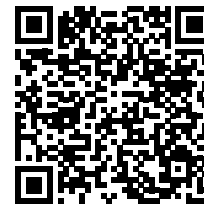
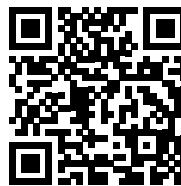

## Account registration

You must first register to be able to use the Door Entry CLASSE100X app and thus use the interface functions with your Classe100 X16E.

After opening the app follow the registration instructions:

When the account has been created it will be common to all the connected Legrand/BTicino device app

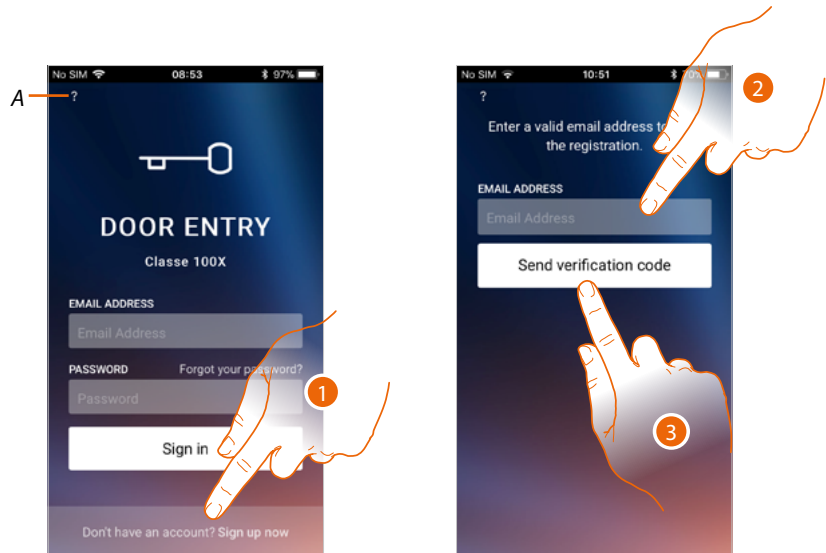

A Access the [Help](#) section

1. Touch to register and create an account
2. Enter the email address where the system can send a verification code
3. Touch to confirm the forwarding of the verification code

After confirming, the system will send the data (verification code) to the email address indicated by you in the registration phase for the first access.

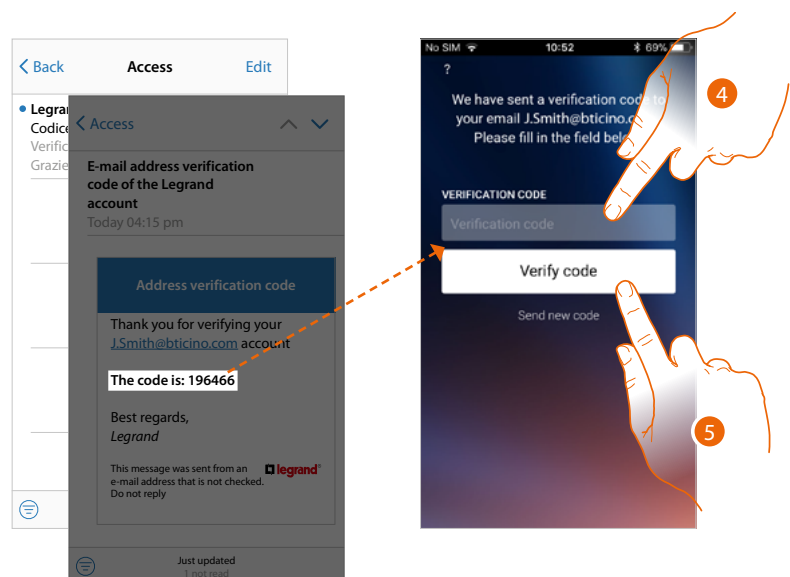

4. Enter the verification code received by e-mail
5. Touch to confirm

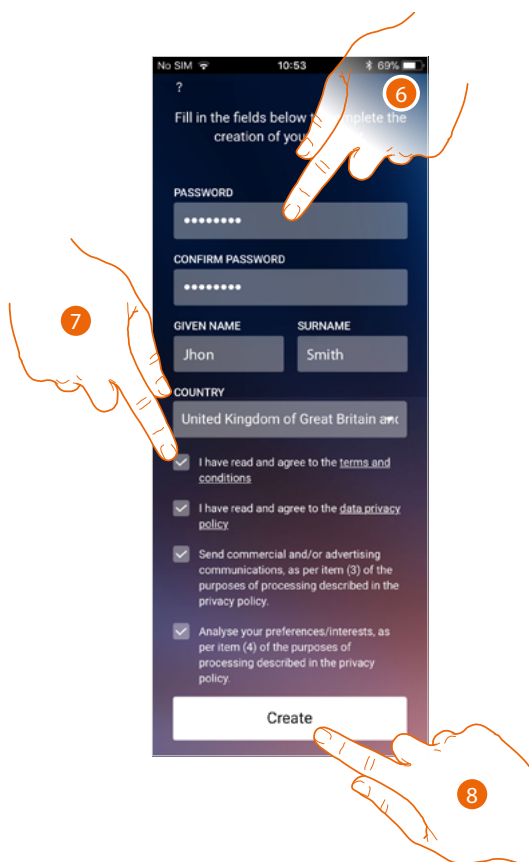

6. Enter a password and fill the fields with your details.
7. Tick to accept the terms and conditions of use laid down in the associated text (obligatory).
8. Touch to continue.

## Authentication

After registering with the portal, you can authenticate by entering email and password.

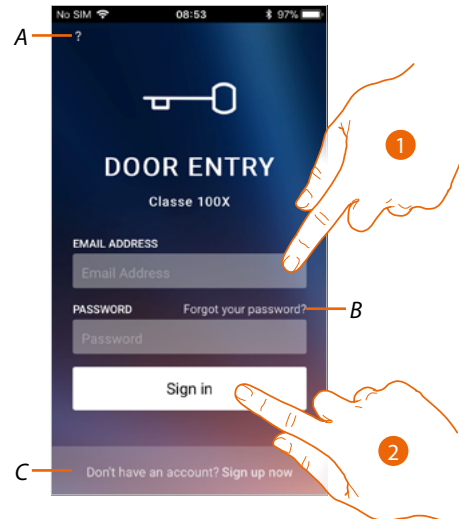

A Access the [Help](#) section

B Touch to start the [password recovery](#) procedure

C Touch to [create a new account](#)

1. Enter email and password.

2. Touch to access.

**Note:** after three failed access attempts (wrong password) in an hour, the system blocks the account for 15 minutes.

## Forgotten password

When you have forgotten the password:

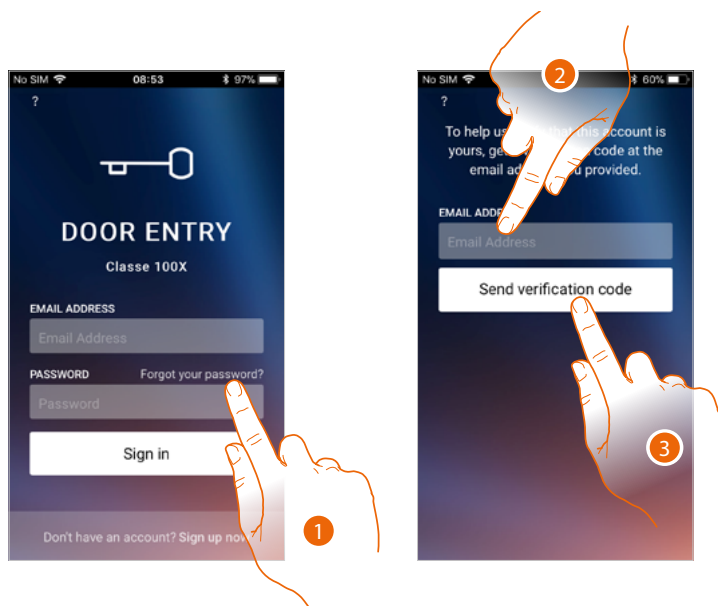

1. Touch to activate the password recovery procedure.
2. Enter the email address where the system can send a verification code.
3. Touch to confirm the forwarding of the verification code.

After confirming, the system will send the data (verification code) to the email address indicated by you for the first access.

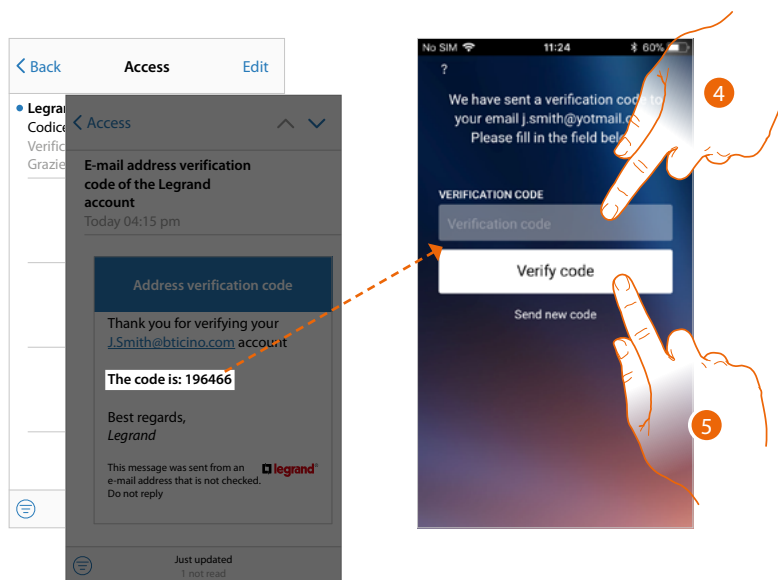

4. Enter the verification code received by e-mail.
5. Touch to verify the code.

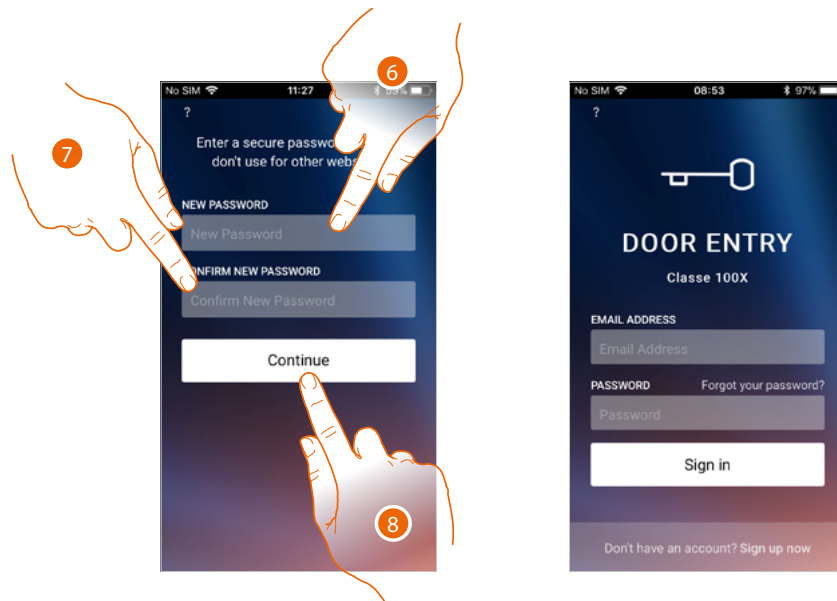

6. Enter the new password.  
For security reasons enter a new password with these features:
  - minimum length 8 characters;
  - must contain at least one letter and one number;
  - it must be different from the last 5 passwords used.
7. Enter the password again.
8. Touch to confirm. The Home Page will be displayed so that the authentication procedure can be completed.

## Help

In this section you can display the FAQ and send a notification about a problem you have found.

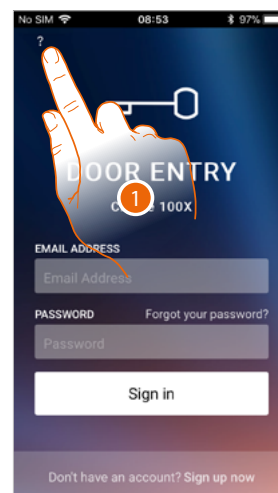

1. Touch to enter the HELP section.

## FAQ

In this section it is possible to display FAQ (and their answers) regarding the use of the Door entry Classe100X App.

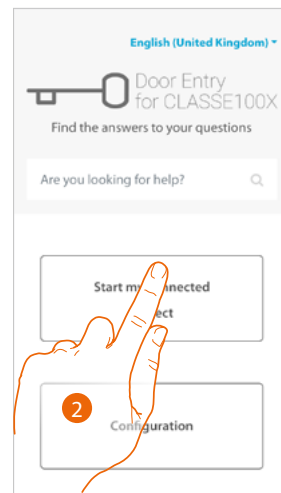
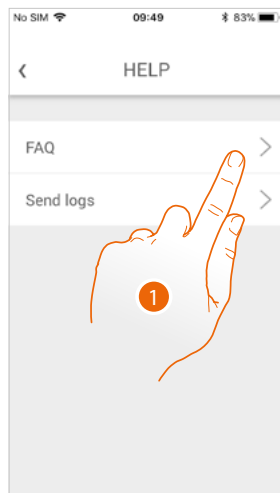

1. Touch to enter the FAQ section
2. Select the topic on which you require clarifications.

## Sending log

In this section you can send a notification about a problem you have found.

**Note:** you will not receive a direct answer, but your signal will be used by developers to improve the service.

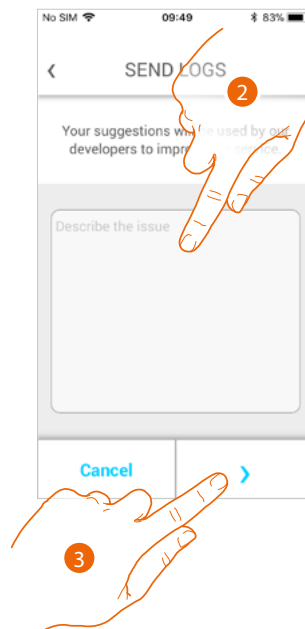
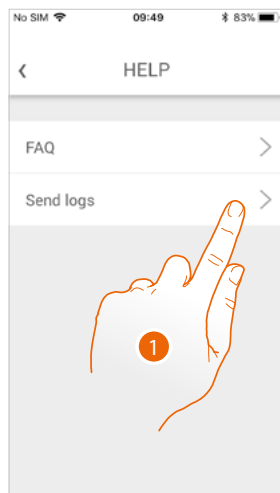

1. Touch to enter the Sending log section
2. Describe the problem you want to point out in the correct field.
3. Touch to send the message to the after-sales service.



## Association of the device

After registering and authenticating for the first time (the first smartphone) you will be shown a tutorial. Follow this to associate your account to the Classe100 X16E. This operation is only necessary on the first access and allows you to connect the Classe100 X16E to your home Wi-Fi network and activate the connection between the two devices. You can also invite other users so that they can use the connected Classe100 X16E functions.

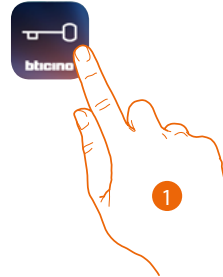

### 1. Open the app

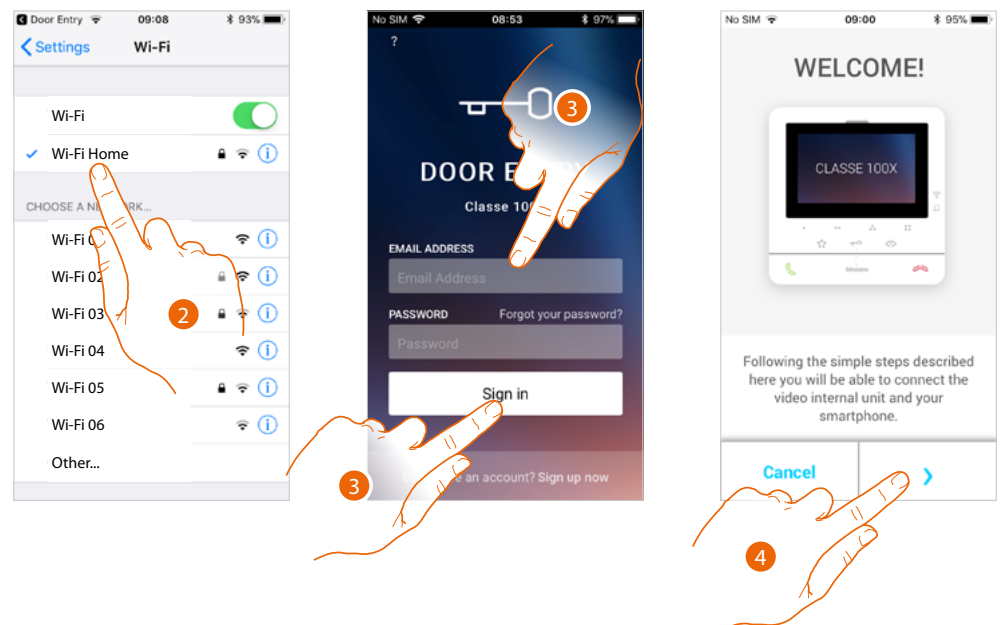

2. First of all connect your smartphone to the home Wi-Fi network
3. Authenticate after registering.
4. As the smartphone has not yet been associated to the C100X16E, this screen appears. Touch to start the association procedure.

**Note:** if the association procedure is interrupted before it is completed, it is necessary to reset the Classe100 X16E following the procedure.

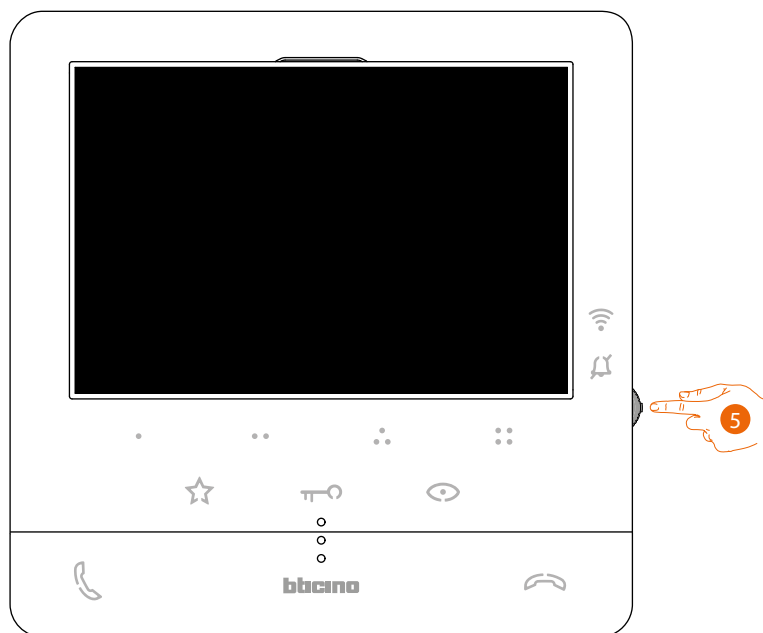

5. From stand-by press the joystick to activate the display.

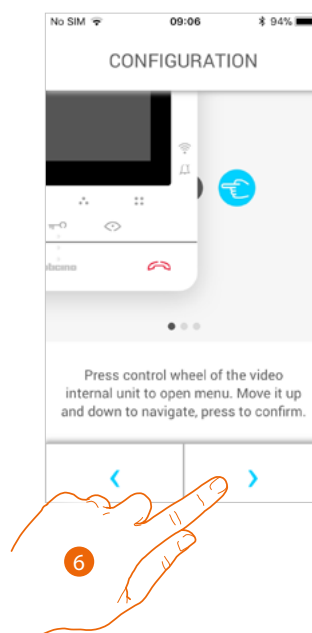

6. Touch to continue.

This screen is displayed to indicate that your Classe100 X16E has never been associated. The screen will disappear once the procedure has been completed successfully.



7. Move the joystick down to select the Wi-Fi settings page.

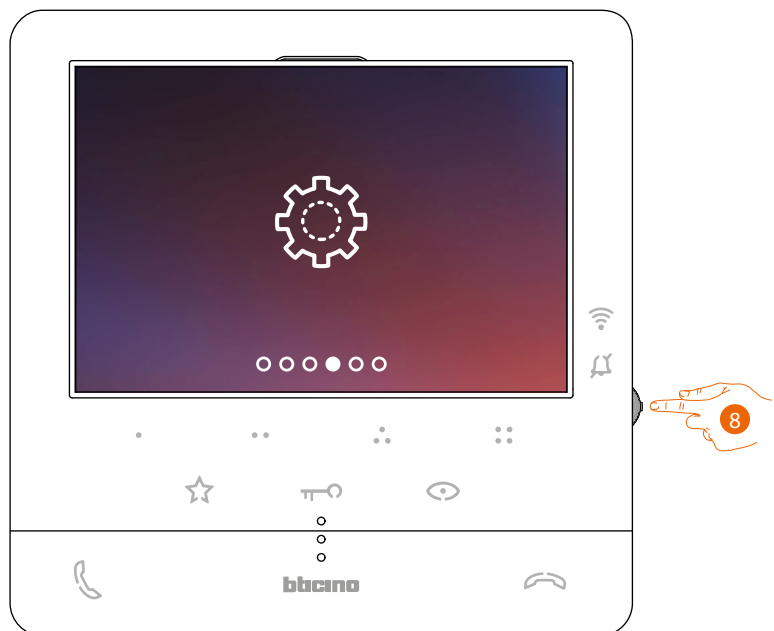

8. Press the joystick to access the page



9. Touch to activate the temporary Wi-Fi network created by your C100X16E.  
This screen appears, followed by a qrcode.

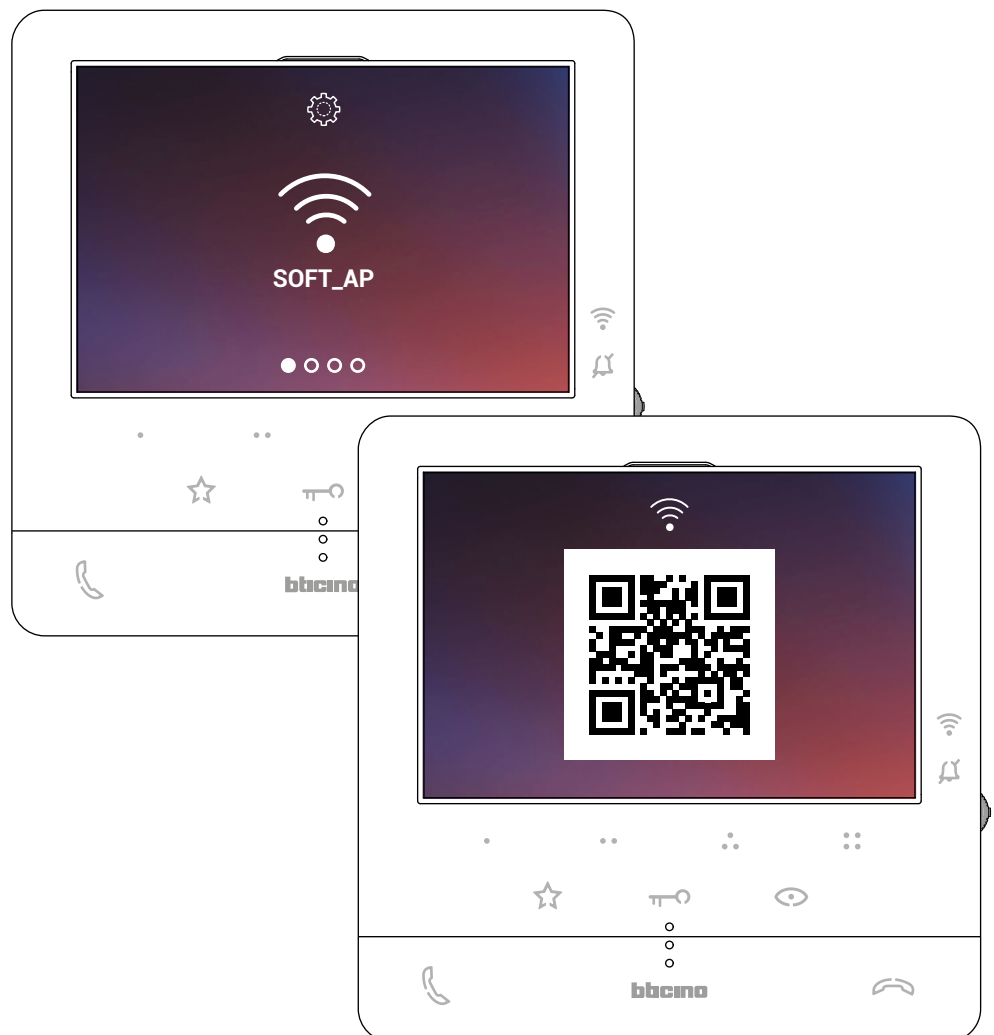

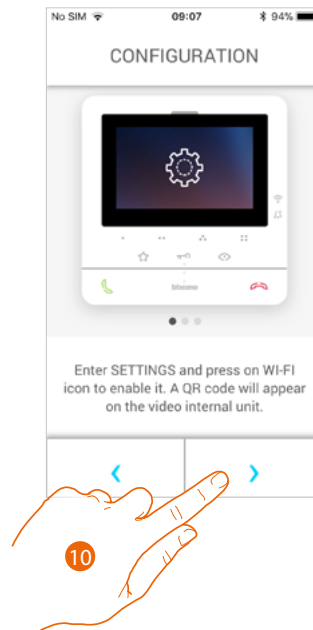

10. Touch to continue.



11. Using the smartphone, scan the QR Code.

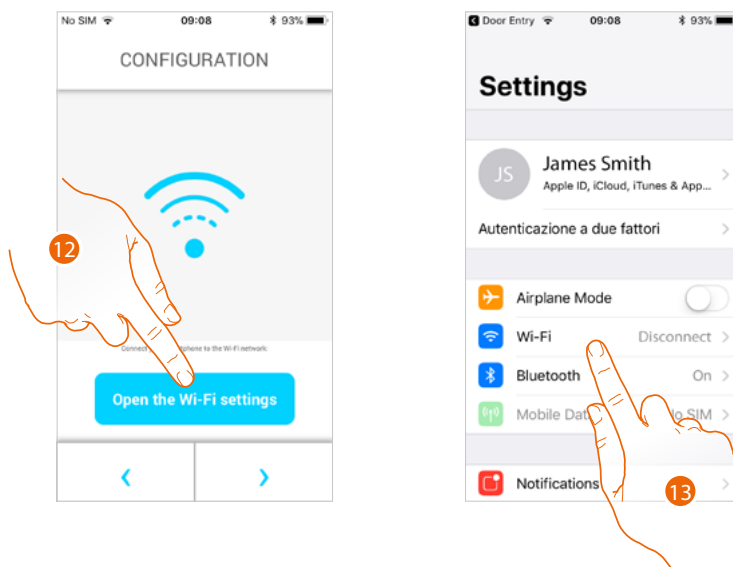

12. Touch to access your smartphone settings

13. Touch to access the Wi-Fi network settings

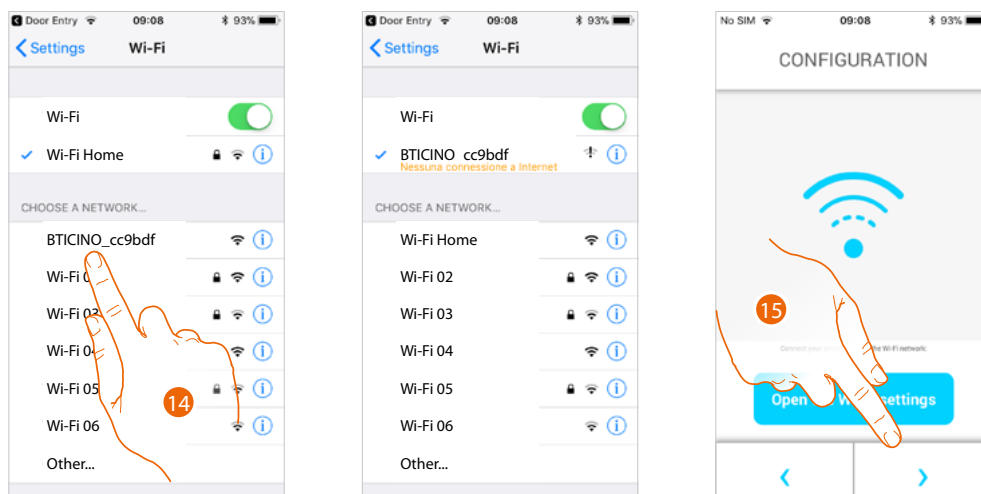

14. Select the temporary network which the C100X16E creates to connect to the smartphone (e.g. "BTICINO\_cc9bdf").

**Note:** this procedure could vary based on the smartphone used.

15. Your C100X16E is now connected to the temporary network (A); touch to continue

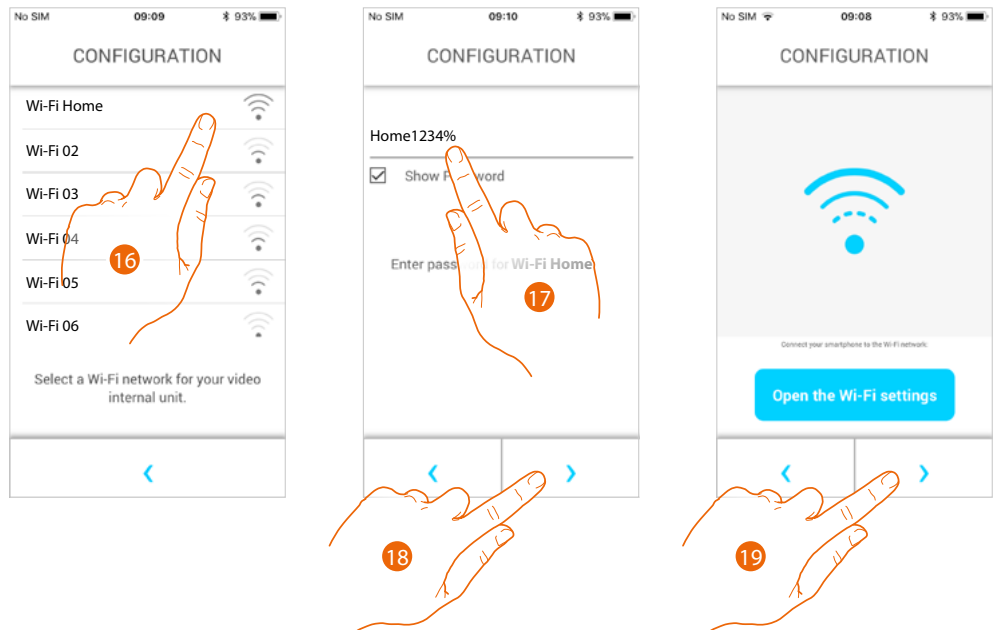

16. Now select the home Wi-Fi network to which the C100X16E will be connected.

17. Enter the home Wi-Fi network password

18. Touch to confirm

19. Touch to continue.

C100X16E and the smartphone now start to exchange data. This procedure may take a few minutes.

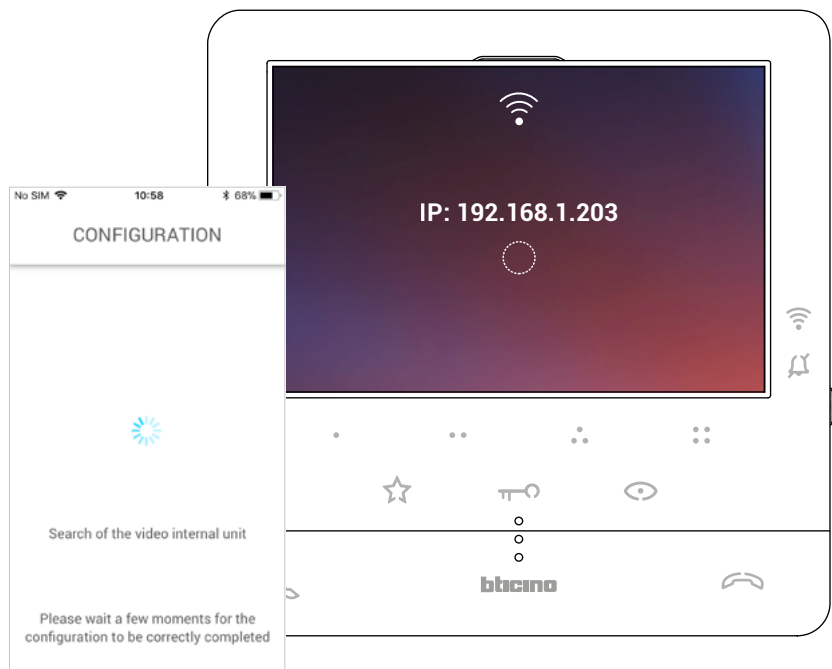

The completion of the association is confirmed by the confirmation screen.

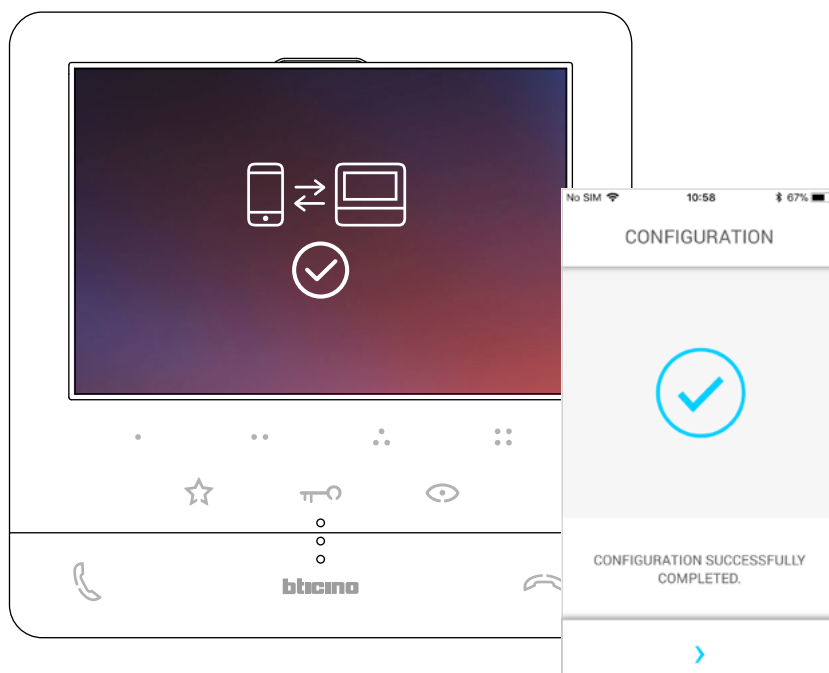

Classe100 X16E is now connected to the home Wi-Fi network

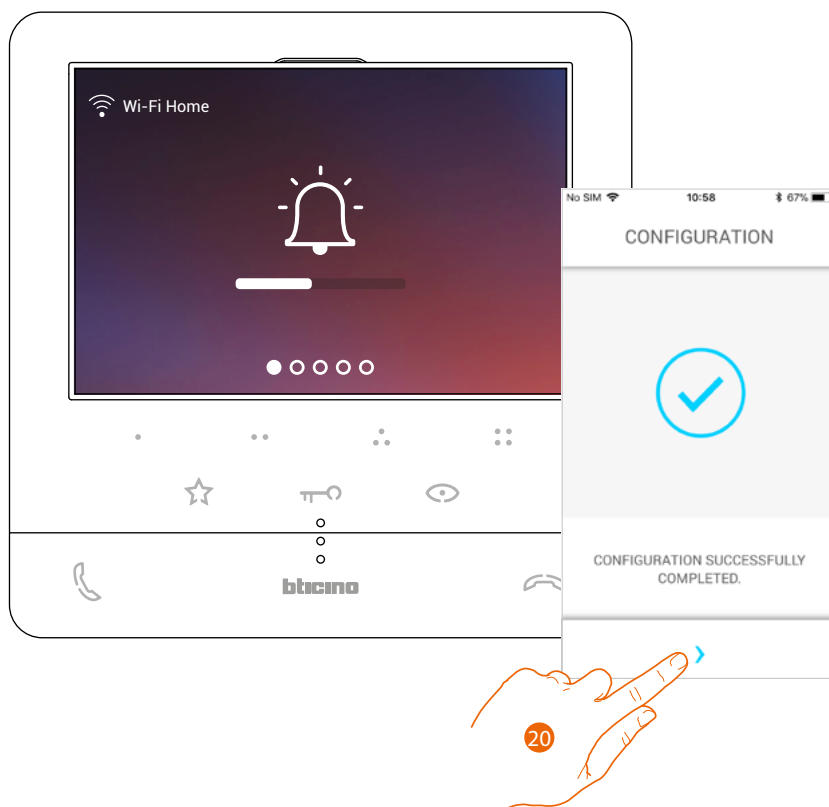

20. Touch to continue.

**Note:** The disconnection of Classe100 X16E from the Wi-Fi network, or the reset of the Wi-Fi network to change the password, are possible using the specific menu, [Wi-Fi settings](#).



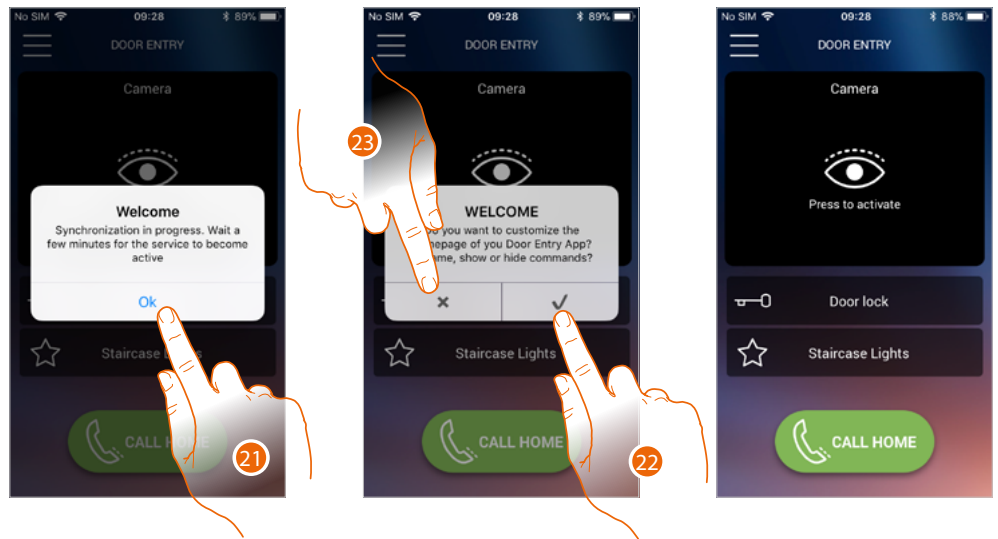

21. Touch to continue.

22. Touch to immediately customise the Home Page (see [Home Page customisation](#)).

Or

23. Touch to delay it to a later date. You will be directed to the [Home page](#).

## Home page

The Home Page of the Door entry Classe100X App can be **customised** based on personal needs. **After being authenticated**, from this page you can interact with your Classe100 X16E and with the video door entry system.

You can also make various settings via the pull-down menu.

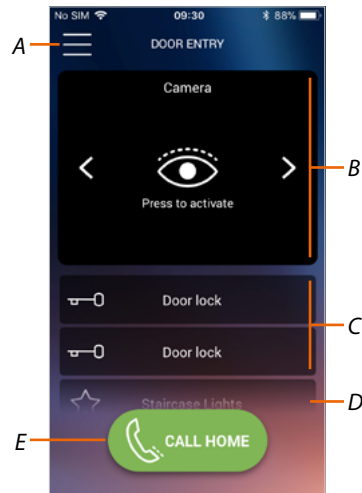

A Pull-down menu.

B Selection and display the cameras or Entrance Panels.

C Door lock activation.

D Staircase light activation.

E Call your Classe100 X16E.

**Note:** the DOOR ENTRY APP operation with screen off (background) may be compromised by the applications installed on the smartphone that:

- optimise the use of the battery and the energy saving;
- protect the smartphone (antivirus or similar programs).

**Note:** the appearance of the Home Page and the functions available depend on:

- the devices installed on your system;
- the configuration of your Classe100 X16E;
- how you have customised the Home Page of your Door entry Classe100X App.

## Display the cameras or Entrance Panels

By means of this function you can display the cameras and Entrance Panels configured by your installer (see [Configuration](#)).

You can also display the associated NETATMO cameras as indicated in the [Netatmo Cameras](#) section

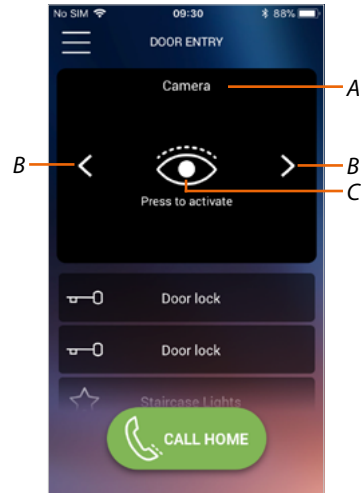

A Name of camera or Entrance Panel.

B Scroll the cameras or Entrance Panels.

C Display the camera or Entrance Panel.

- NETATMO camera 
- Camera 

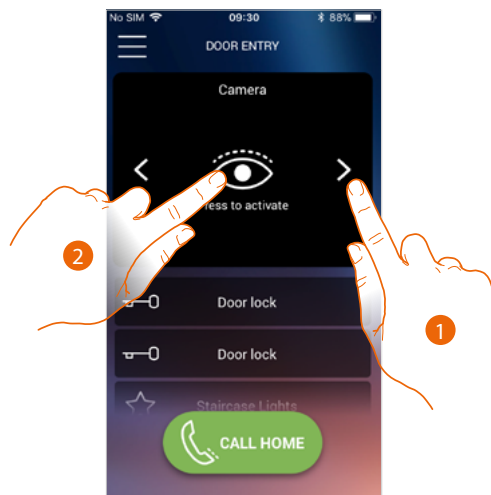

1. Select the desired camera or Entrance Panel.

2. Touch to display.

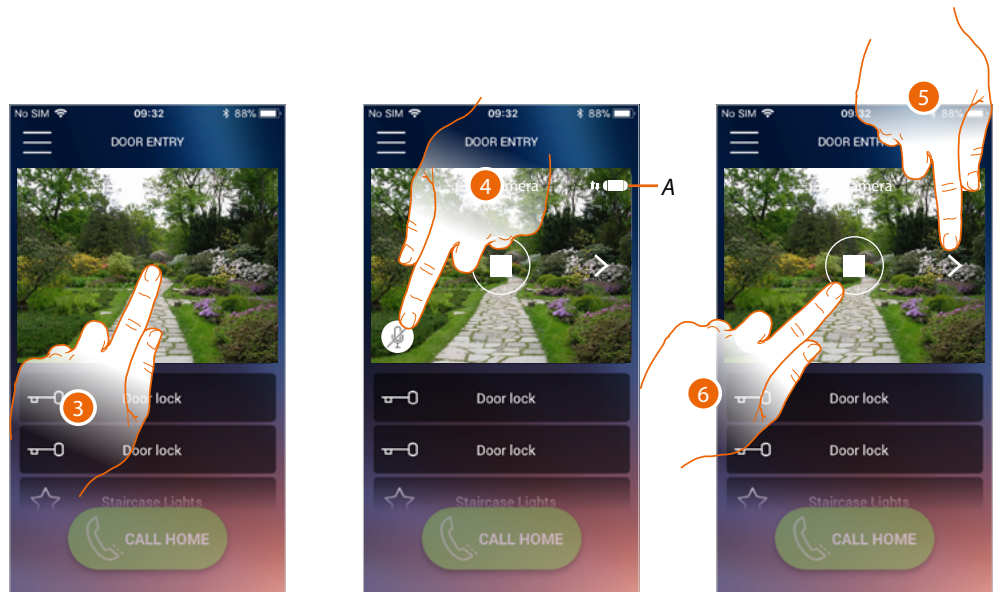

3. Touch to make the management keys appear

A Call quality indicator: indicates if the conditions are good enough (Cloud, Wi-Fi and 3G/4G connection) for the communication.

 Good quality

 Average quality

 Poor quality

4. Touch to activate the microphone and communicate with the Entrance Panel.

5. Touch to cycle to the next camera.

**Note:** NETATMO cameras are not included in the cycling function, and therefore will not be displayed. To display a Netatmo camera refer to the [Netatmo Cameras](#) section

6. Touch to stop the image capturing

## Open door locks

By means of this function you can open the door locks of the Entrance Panels configured on the device by your installer.

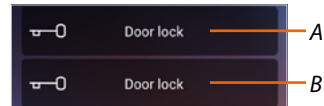

A Door lock of the associated Entrance Panel.

B Other door locks.

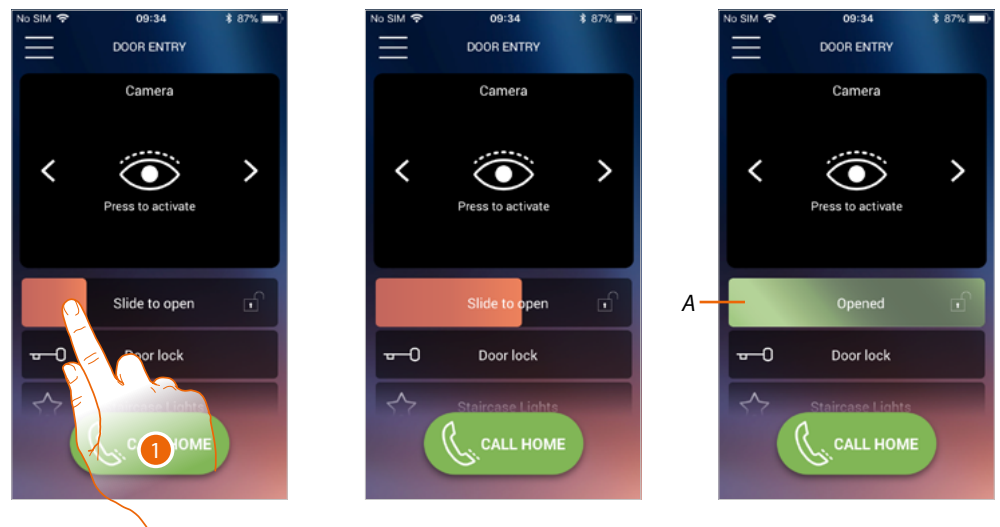

1. Drag to the right to activate the door lock.

A When it becomes green the door lock has been activated. If it remains red, the command has not been performed correctly.

## Staircase Lights

This function can be used to switch the Staircase Lights on.

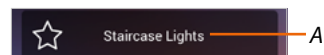

A Staircase light activation.

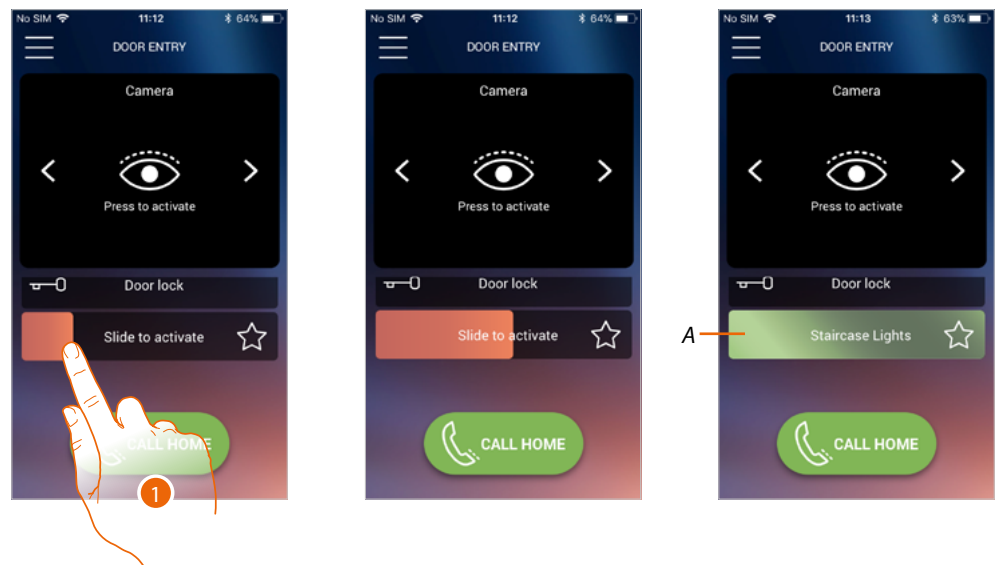

1. Drag to the right to switch the staircase light on.

A When it becomes green the light has been switched on. If it remains red, the command has not been performed correctly.

## To receive a video door entry call

Via this function you can receive the calls from the Entrance Panel.

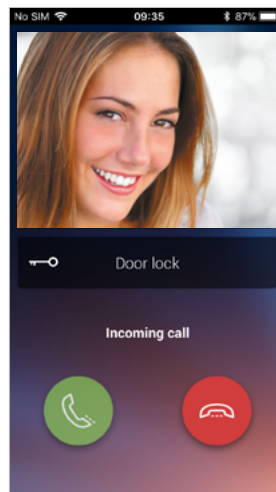

With smartphone in stand-by, following a call from the Entrance Panel:

- on Android, the image taken with the call\* management icons appears;
- on iOS, the call notification appears;
- both systems will receive a push notification.

*\*The first three smartphones which receive the call will see the video image directly before answering, the others instead only after answering. The answer from one smartphone excludes all the others.*

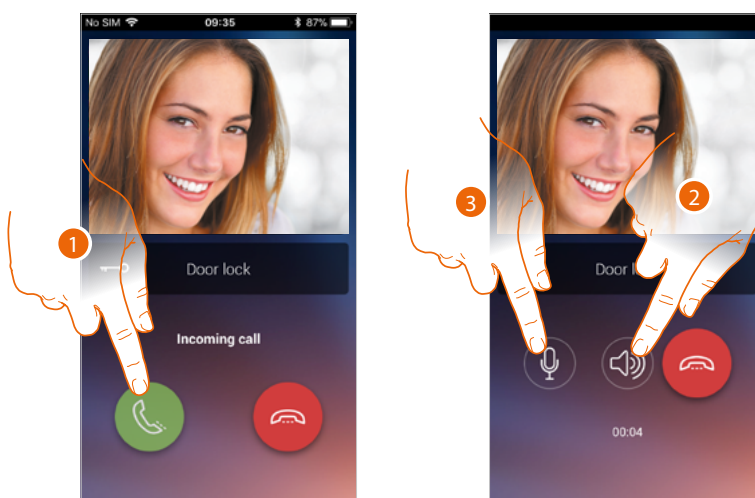

1. Touch to activate the audio and answer, the call audio is played automatically hands free.
2. Touch to change from hands-free mode to telephone mode.
3. If necessary touch to silence the microphone.

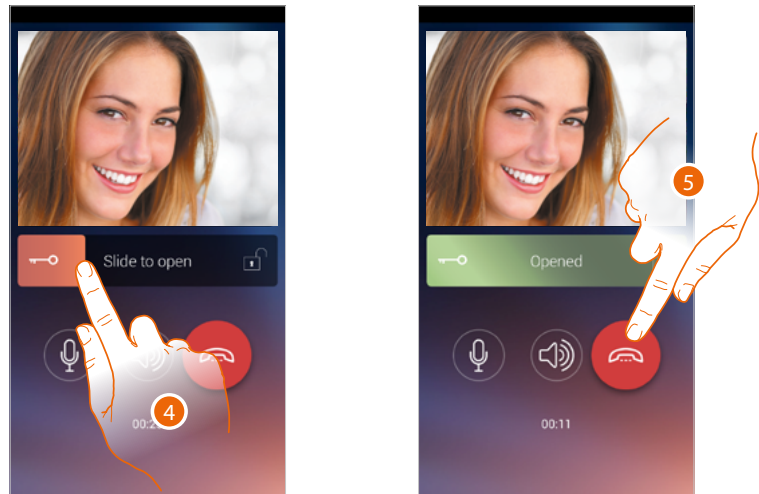

4. You can also open the door lock of the Entrance Panel from which the call comes, by dragging the switch. When it becomes green the door lock has been activated. If it remains red, the command has not been performed correctly.
5. Touch to end the call.

In case of installation of a Welcome NETATMO camera, which then detects a presence in your home, when a call is received from the Entrance Panel, or in case of automatic switching on, using the face recognition function the Door Entry CLASSE100x will be able to show you if there is anyone in your home ("At home" function of the NETATMO Security App.) capable of managing the received call.

**Note:** this function is only available if monitoring is active in the NETATMO Security App, and if the **NETATMO camera has been enabled** in Classe100 X16E.



A. Entrance Panel image display

B. Name of the individual detected in the home by the Welcome NETATMO camera

**Note:** if the camera detects unknown individuals, their number is displayed

By interfacing with the "At home" function of the NETATMO Security App, the Door Entry CLASSE100X App shows if anyone who can manage the call from the Entrance Panel is in the home. When the Welcome NETATMO camera detects a known face, this is inserted in the "At home" section.

After a certain period of time (customisable in the NETATMO Security App) with the camera no longer detecting the face, this is moved to the "Out" section.

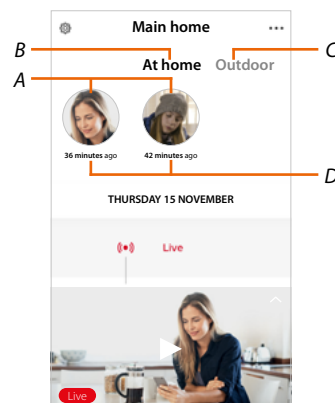
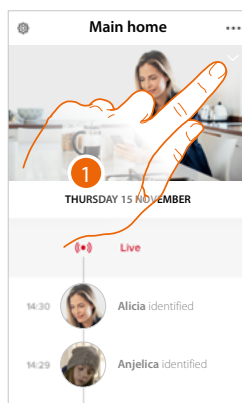

1. Touch to display who is in the "At home" section.

A. Individuals in the "At home" section

B. "At home" section

C. "Outdoor" section

D. Indication of the time since the face was last detected.



When the NETATMO Security App detects a face, it always includes it in the “At home” section. After a certain amount of time (1h minimum and 12h maximum) with the camera no longer detecting the face, this is moved to the “Out” section.

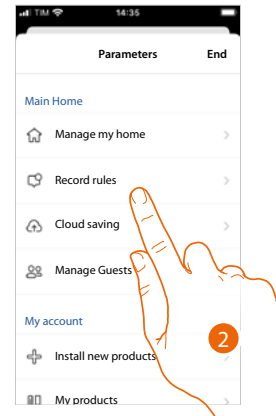
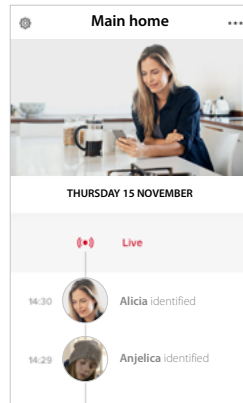

1. Touch to open the Settings menu.
2. Touch to set the rules for the recordings

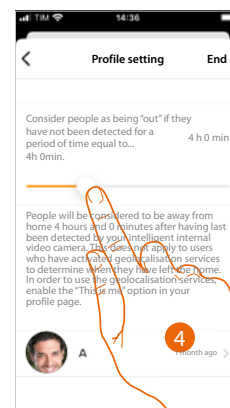
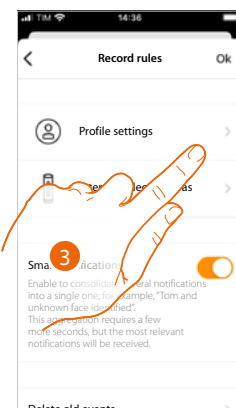

3. Touch to set the rules for the profiles
4. Touch to set the time after which the face will be moved to the “Out” section.

It is also possible to manually move the face from the “Out” to the “At home” section.

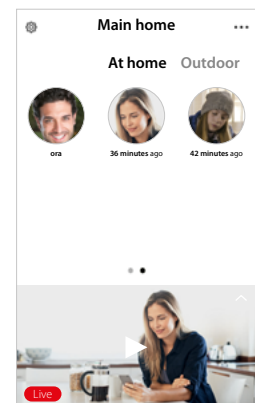
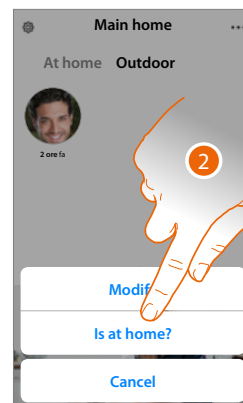
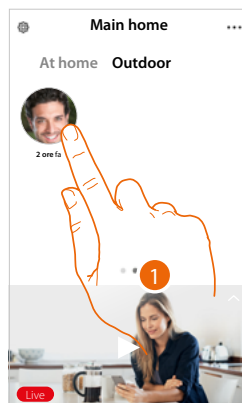

1. Touch and hold the finger on the face of the person to move to the “At home” section.
2. Touch to move to the “At home” section.

## Call home: Call your Classe100 X16E

You can communicate with your Classe100 X16E by means of this function.

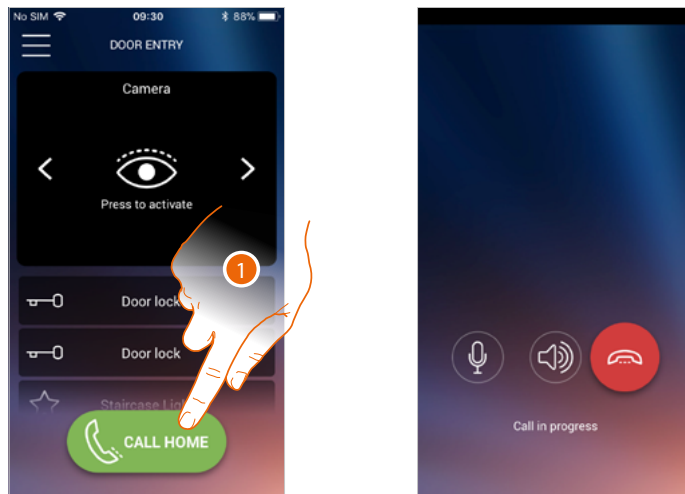

1. Touch to call the Classe100 X16E.

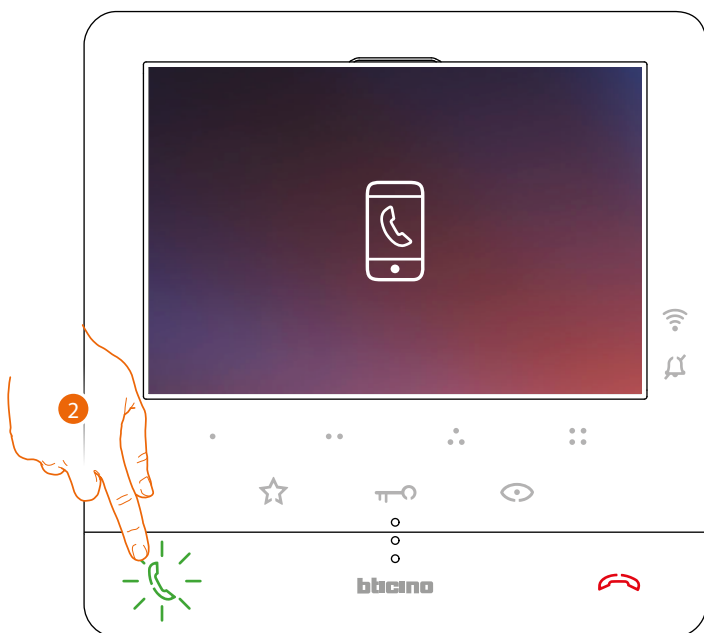

2. When the Classe100 X16E call answers the audio communication is activated.

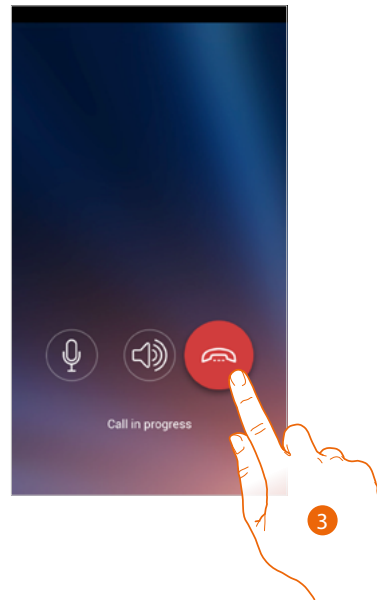

3. Touch to end the call.

## Menu

This pull-down menu can be used to manage the associated users, customise the Home Page, set the Wi-Fi connection, reset and update your Classe100 X16E.

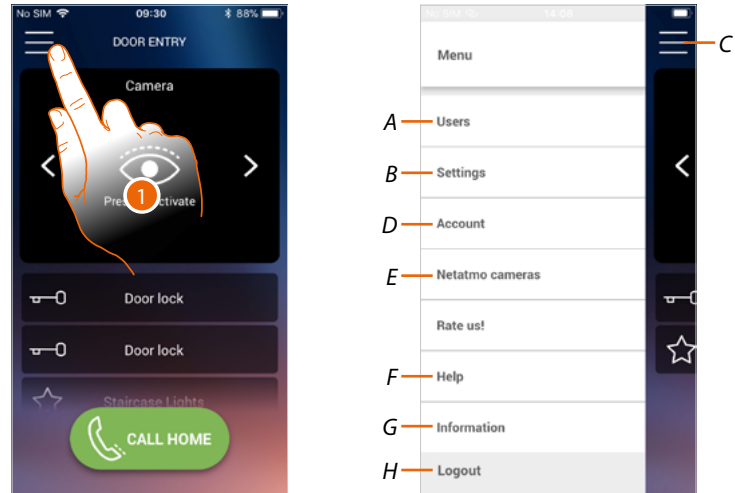

1. Touch to open the pull-down menu.
- A Opens the Users section.
- B Opens the Settings section.
- C Closes the pull-down menu.
- D Opens the Account section.
- E *Netatmo cameras*
- F Opens the FAQ and Sending log page
- G Opens a screen with some information on the APP (version etc.).
- H Log out.

## Users

This section can be used:

- display the associated users and the devices with which you want to interact using your Classe100 X16E.
- dissociate users or devices;
- to invite other users to associate their accounts to your Classe100 X16E, so that they can use the connected Classe100 X16E functions.

If the main user is dissociated (★), it will be necessary to indicate a replacement.

The main user is the first to have made the association, he can dissociate all accounts, while other users can only dissociate themselves.

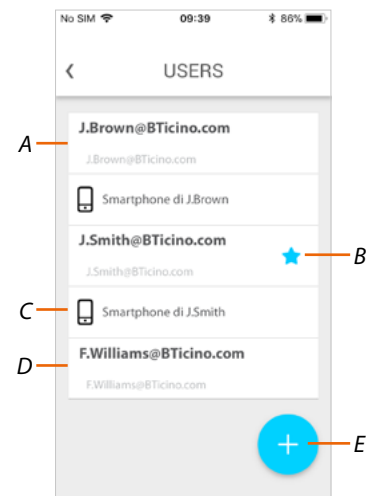
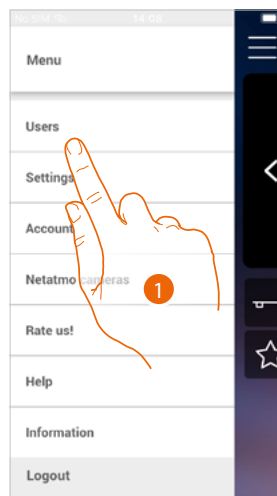

1. Touch to open the user section.
- A Invited and associated user.
  - B Main user
  - C Smartphone associated to the user.
  - D Invited user but not yet associated.
  - E And start the procedure to invite another user.

## Invites a user

With this procedure you can invite other users to use the functions of your Classe100 X16E. In this way they can use the connected Classe100 X16E functions.

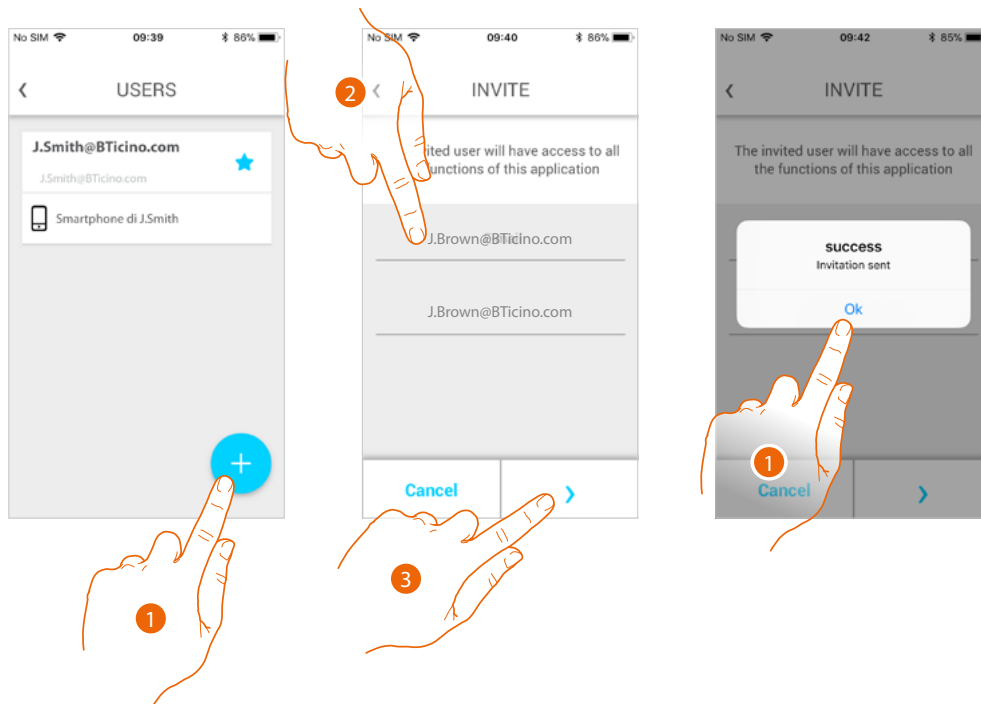

1. Touch to invite another user.
2. Enter the email of the user to associate and confirm it.
3. Touch to confirm the invitation.
4. Invite sent; touch to close.

The invited user will receive an e-mail with the invitation to check your system. Invited users that already **have a Legrand account** will automatically be authorised to access the system after completing the authentication procedure. Those **who don't already have a Legrand account** will be included in the list of invited users (A).

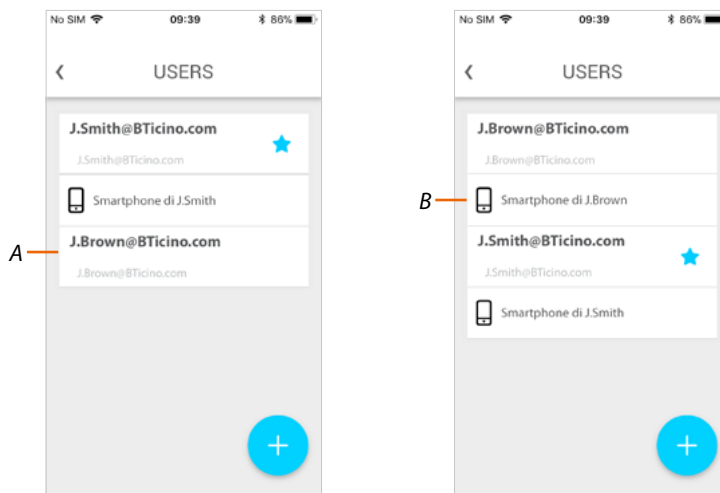

After completing the registration and authentication procedures, the user will be associated to the system, and the device associated to their account will also appear (B).

## Dissociate a smartphone

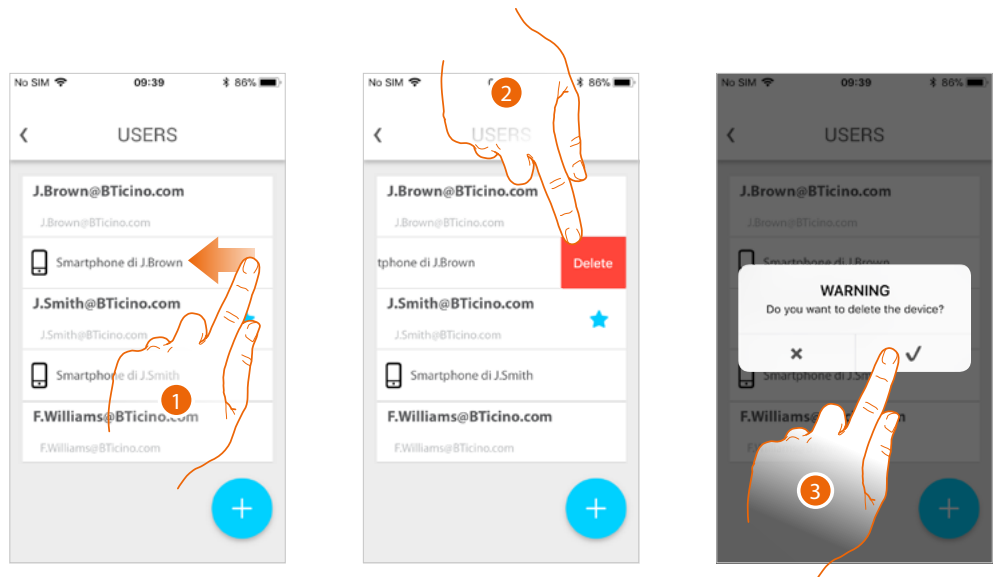

1. Scroll to dissociate a smartphone.
2. Touch to continue.
3. Touch to confirm

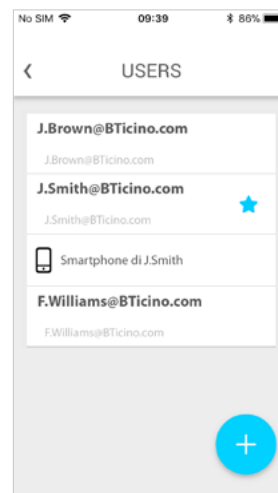

The user will no longer be able to manage the system using that smartphone.  
To re-associate the smartphone simply repeat the [authentication](#) process.

## Dissociate an user

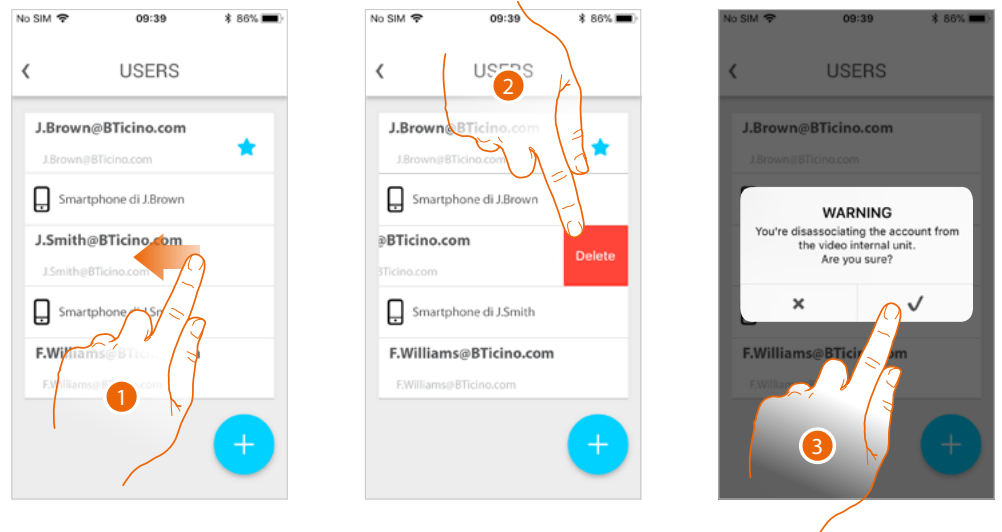

1. Scroll to dissociate a user, and therefore all the devices associated with the same.
2. Touch to continue.
3. Touch to confirm

If your user is the main user, and you want to delete it, it will be necessary to indicate a replacement as main user.

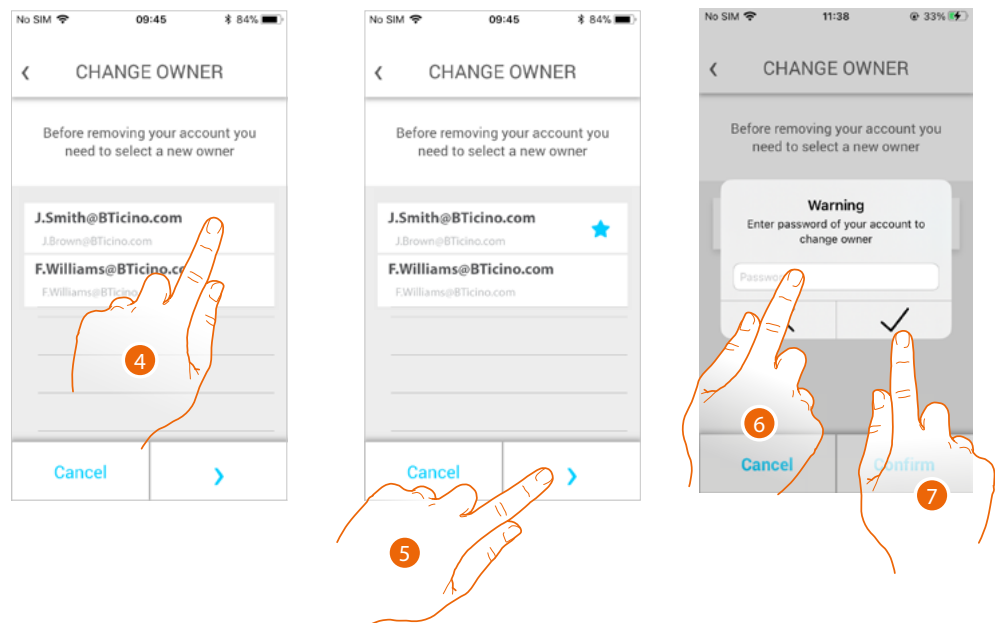

4. Touch to indicate the new main user.
5. Touch to continue.
6. Enter the password of your user.
7. Touch to confirm. You will be redirected to the home page.



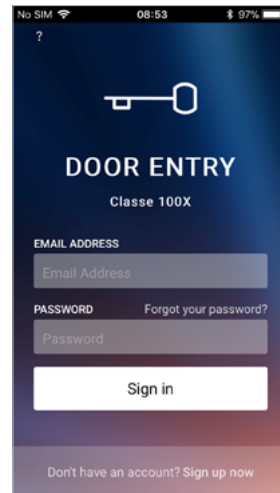

Now you have been dissociated. To return to manage the system, you must be invited again.

**Warning:** if the user to dissociate is the only one left, the system will suggest a tutorial to reset the device.

## Settings

This section can be used to update the firmware, customise the Home Page, set the Wi-Fi connection, reset and update your Classe100 X16E.

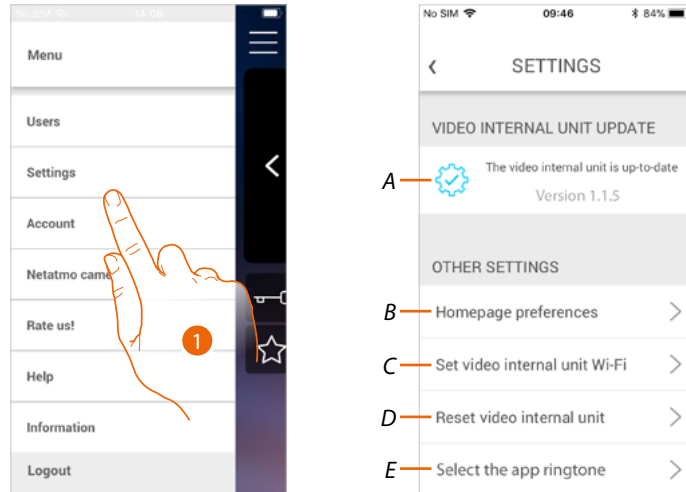

1. Touch to open the setting section.
- A **Update** the Classe100 X16E **firmware**
- B **Customise the Home page.**
- C completes the procedure for **setting the Classe100 X16E Wi-Fi connection.**
- D completes the procedure for **resetting Classe100 X16E.**
- E Opens the page for the selection of the **ringtones from the App.**

## Classe100 X16E firmware update (only if connected to the same Wi-Fi network of the Classe100 X16E)

When a new firmware is released, you will receive a notification on your smartphone, indicating that an update is available. Alternatively, it is also possible to access this section at any time to update the firmware of your Classe100 X16E.

On entering the section, if an update is available, a key will be displayed to install it, otherwise the version currently in the Classe100 X16E appears.

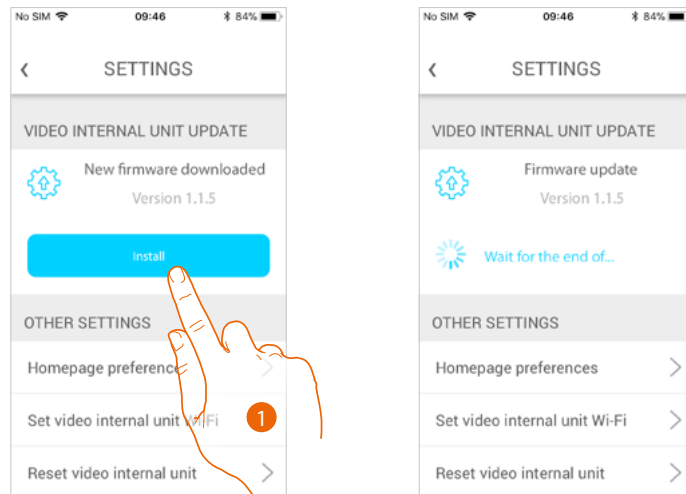

1. Touch to install it.

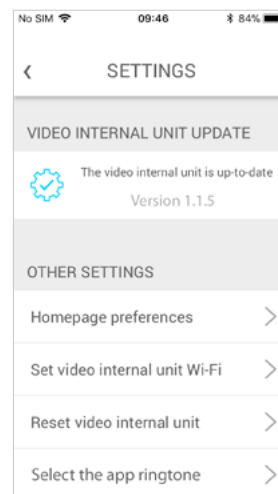

At the end of the installation you can display the firmware version installed in your Classe100 X16E.

## Customise the Home page

This section can be used to rename the Entrance Panel/Camera and Door Lock object in the Home Page.

It is also possible to rename and display the Staircase Lights object and the objects corresponding to the programmable keys of your Classe100 X16E.

**Note:** The number and the types of objects available for customisation depend on the way your installer has configured Classe100 X16E (see [Programming of the programmable keys](#)).

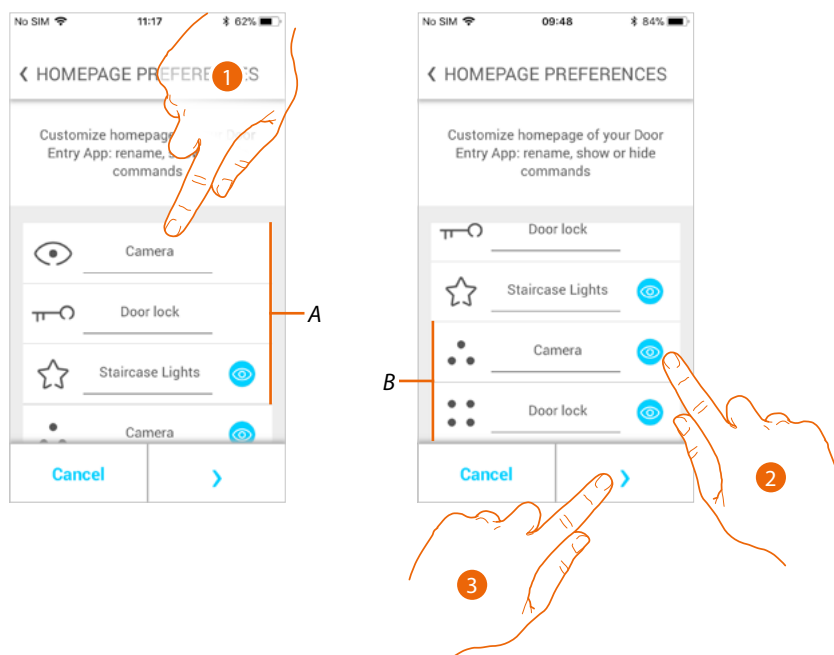

1. Touch to rename the object.
2. Touch to display the object in the Home Page.
3. Touch to confirm the setting and return to the Home Page.

A Video door entry objects.

B Programmable keys.

## Set the video internal unit Wi-Fi

In this section, it is possible to set the Wi-Fi connection of your Classe100 X16E with the home Wi-Fi network.

This procedure can be used to:

- reset the connection on another network (e.g. router replacement)
- reset the connection with the home network changing the password (e.g. new network password).

When accessing the section, a tutorial will guide you through the procedure.

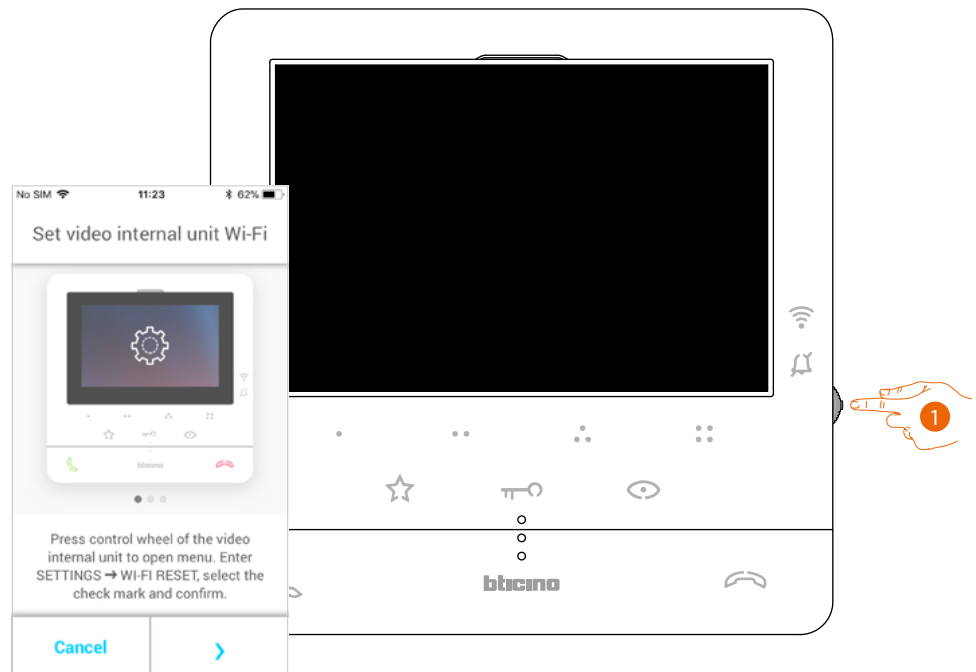

1. From stand-by press the joystick to activate the display.



2. Move the joystick to select the Settings page.

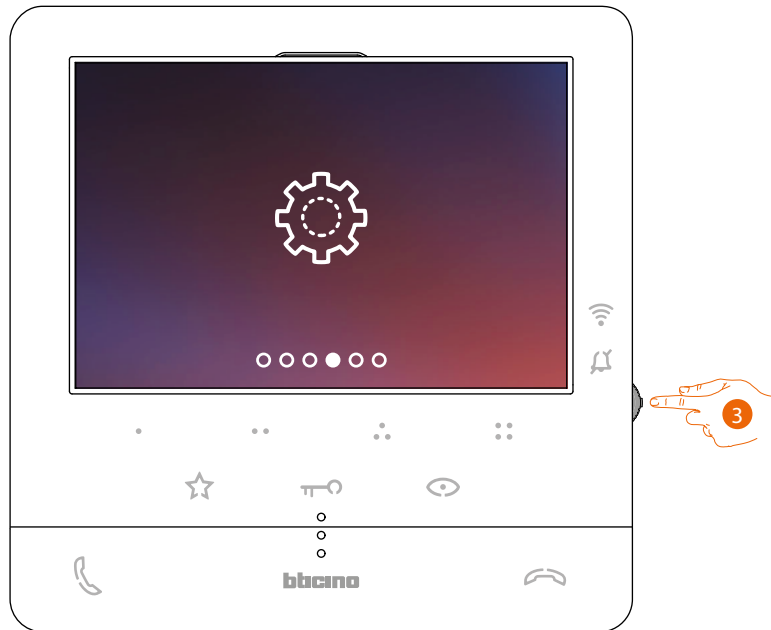

3. Press the joystick to access the page.



4. Move the joystick to select the Reset page.

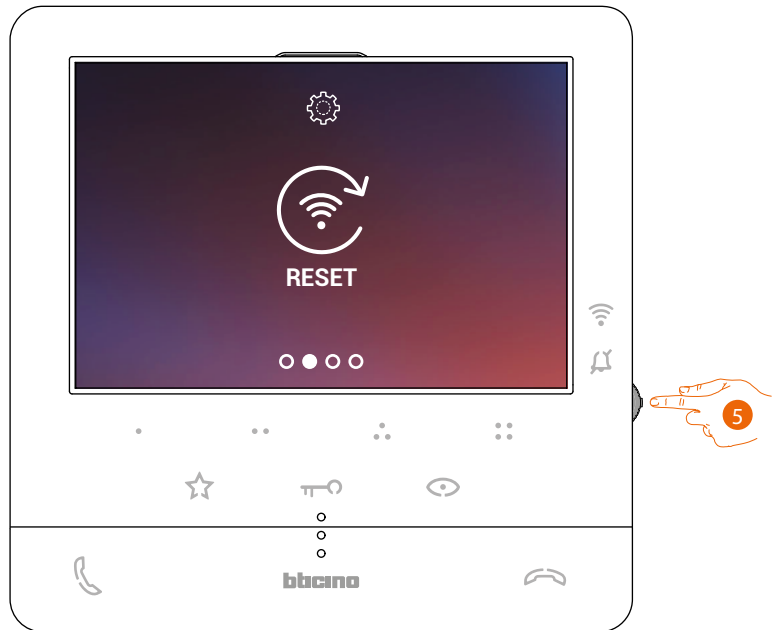

5. Press the Joystick to reset the Wi-Fi network and connect Classe100 X16E to another network, or to the same network with a different password.



6. Move the joystick down to select the confirmation icon.

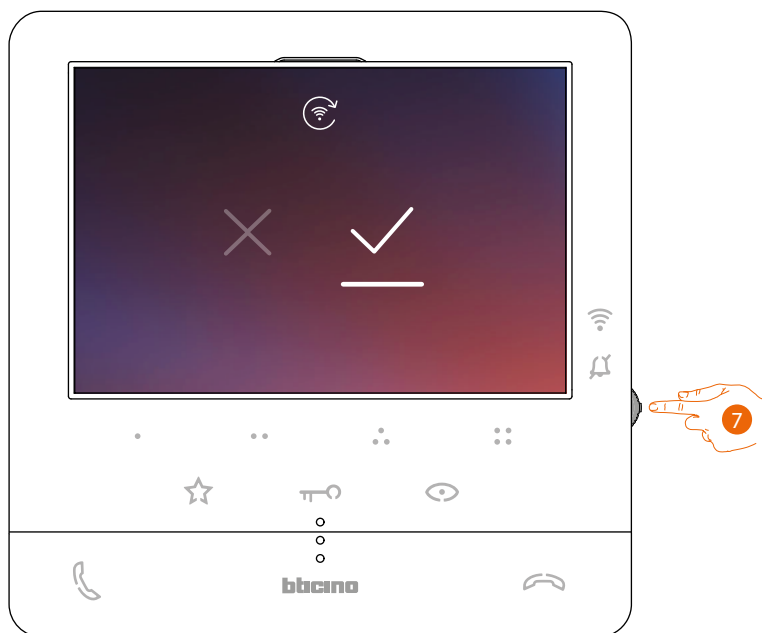

7. Press the joystick to confirm.

The device can now be connected to the Wi-Fi network. The page will show the QR-code to create a new connection



8. Touch to continue.





9. Frame the QR-code with your smartphone and continue the procedure as shown in [Association of the device, item 12.](#)

## Reset the video internal unit

This section can be used to reset Classe100 X16E at the end of the procedure:

- all the accounts (association of accounts to Classe100 X16E) will be deleted;
- the connection of Classe100 X16E to the Wi-Fi network will be deleted;
- all the Home Page customisations set through the App will be deleted;
- the system configuration will be kept for correct operation of the Classe100 X16E.

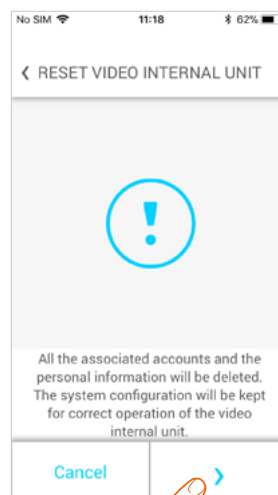

1. Touch to start the procedure.

A tutorial will guide you through the procedure.

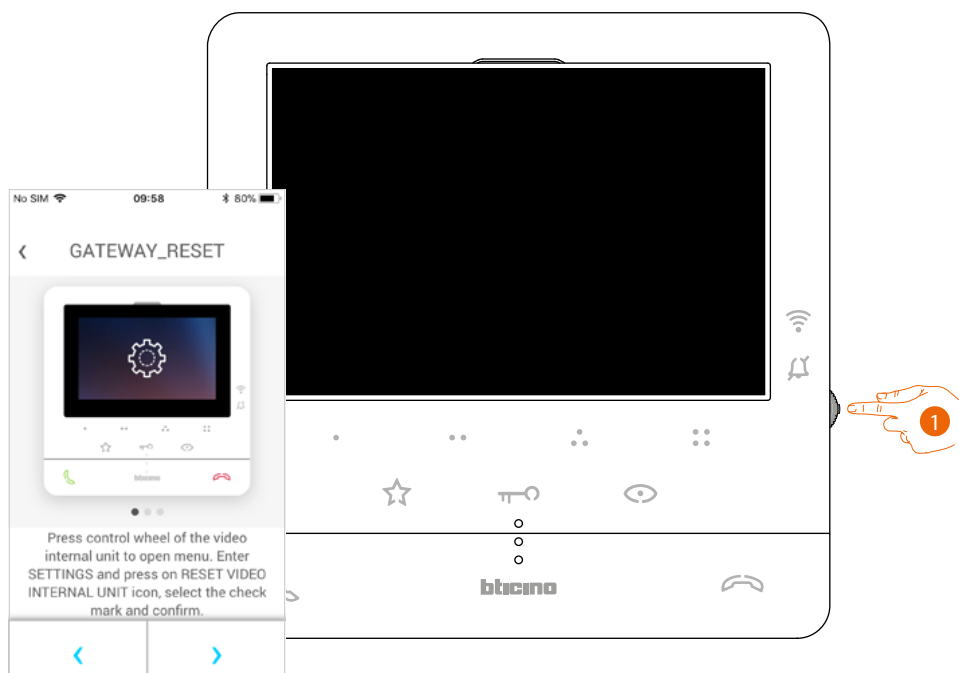

1. From stand-by press the joystick to activate the display.



2. Move the joystick to select the Settings page.

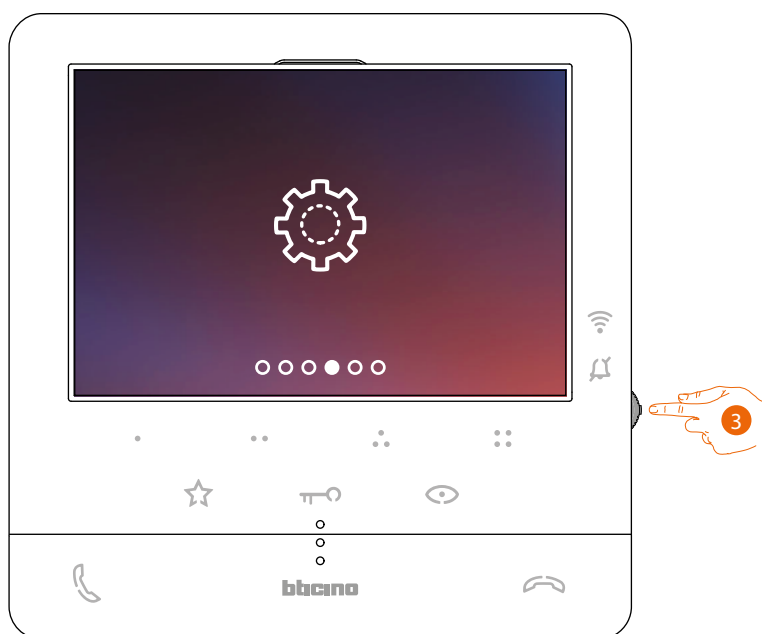

3. Press the joystick to access the page



4. Move the joystick to select the device Reset page.



5. Press the joystick to reset the Classe100 X16E.



6. Move the joystick down to select the confirmation icon.

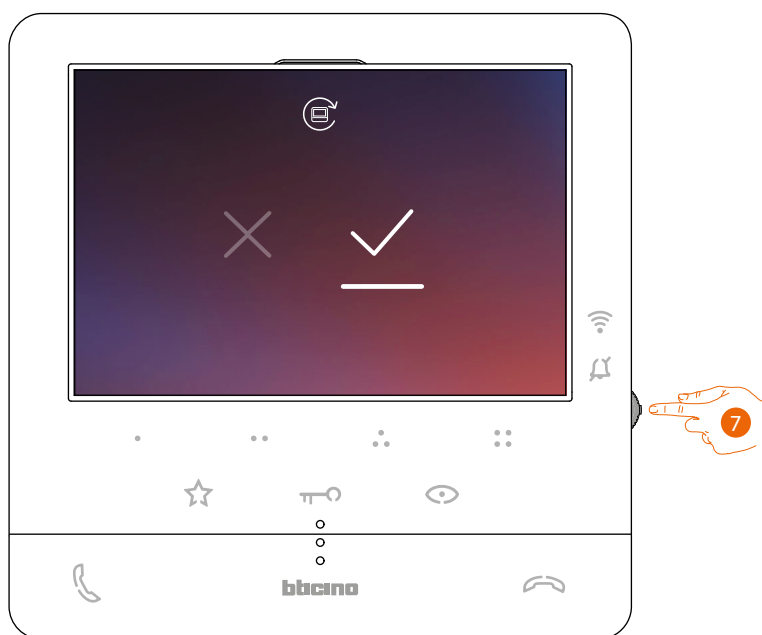

7. Press the joystick to confirm.

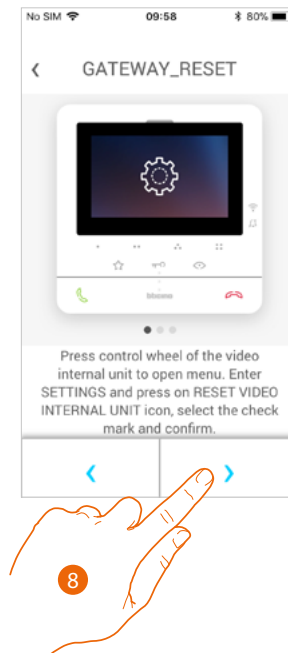

8. Press to perform the reset.

At the end of the procedure the authentication page appears.

It is possible to use your Classe100 X16E for functions that do not require **association** with the Door entry Classe100X App.

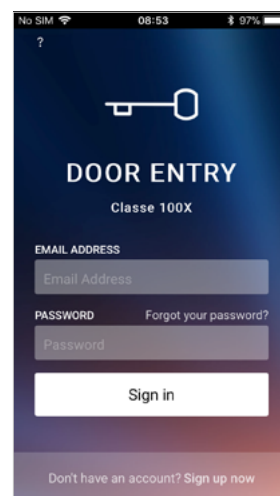

## Select the App ringtone

This section can be used to select the ringtone to associate to the Door Entry CLASSE100x App.

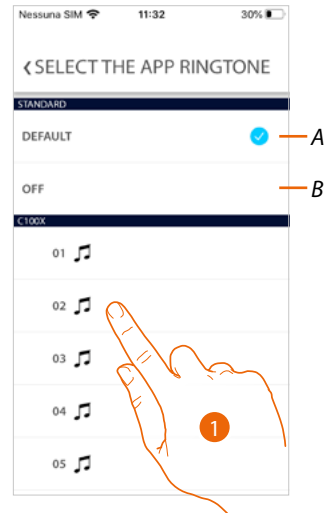

*A Set the default ringtone corresponding to the one set on your smartphone*

*B Disable the ringtone*

1. Touch to select the ringtone among the ones available on CLASSE100 X16E

## Account

The account is common to the connected Legrand/BTicino devices APP

**Note:** the changes to the parameters of this section will be transferred to all the devices with Apps using the Legrand account installed.

In this section you can display and modify your account data and/or cancel it. It is also possible to manage the partner apps.

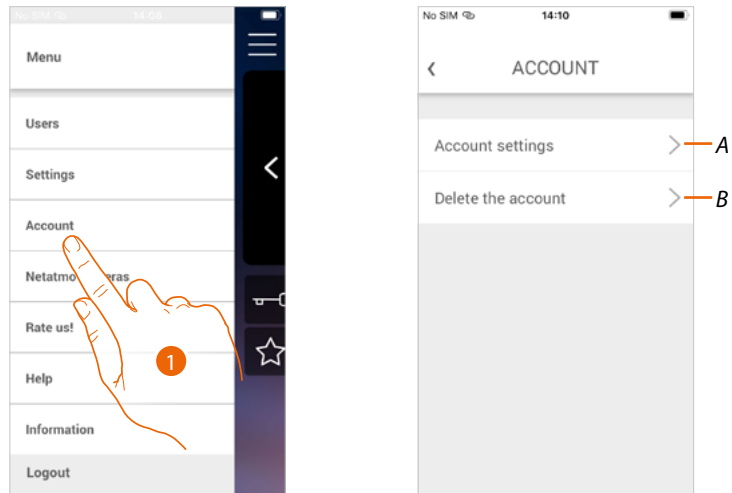

1. Touch to open the Account settings section

A Opens the **Settings** section

B **Delete your account**

## Account settings

This section can be used to change the various parameters of your Legrand account.

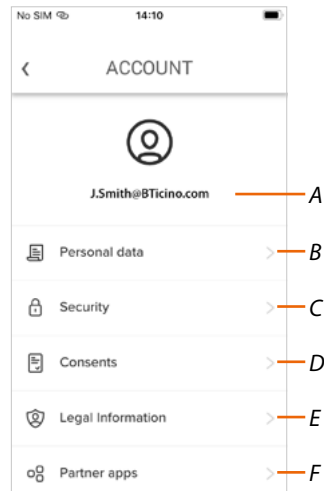

A Account Login/Email address

B Display/modify your Legrand account **registration details**

C Modify some **security parameters** of your account, such as password and disconnection from all devices

D Manage your communication **authorisations** and other aspects of your personal details

E Display **contract terms and conditions** regarding the Legrand Apps that you are using

F Manage **partner Apps** to which your account is connected (e.g. Google Home etc.)



## Personal data

This section may be used to change some data of the account currently managing the device, or to replace it with another registered Legrand account.

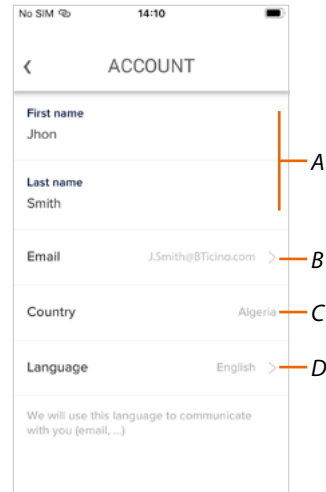

A Account name/surname, touch to change and then touch the key to confirm

B Nation of residence

C Current account

D Communication language

Email (device management account change)

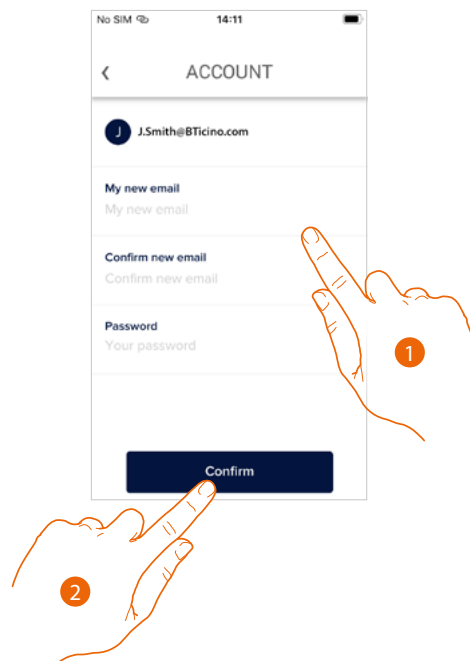

1. Enter the login details (email and password) of the new registered Legrand account to be used to manage the device

2. Touch to confirm

## Language

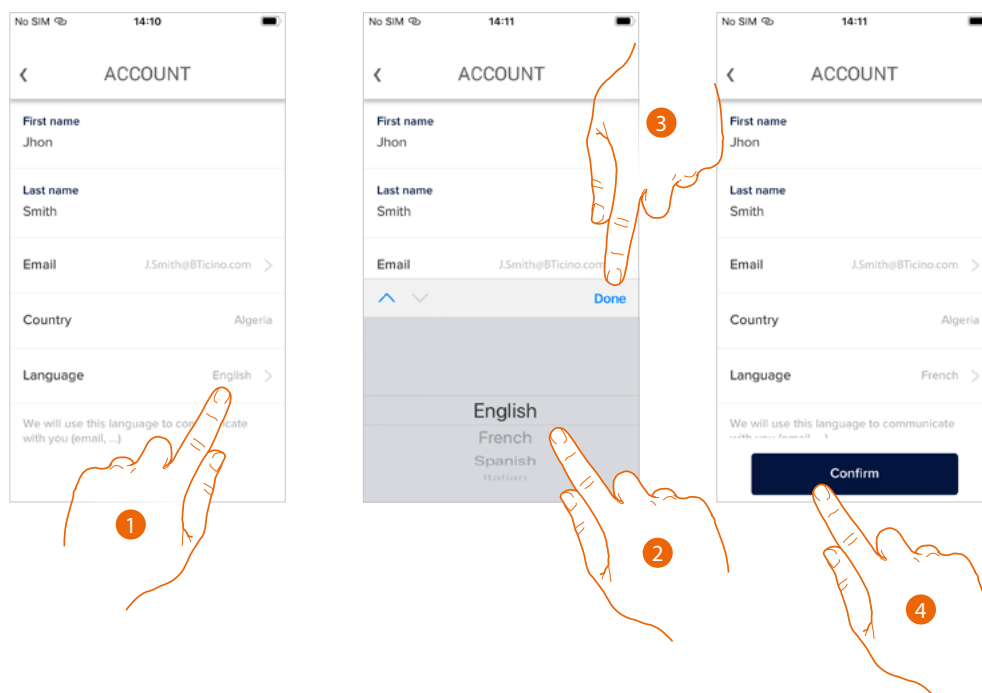

1. Touch to change the language used by the App to send you mail notifications,etc.
2. Select the language
3. Touch to end
4. Touch to confirm

## Security

This section can be used to change the password of your account and to disconnect it from all devices.

The disconnection of your account from all devices is useful in case one of your devices is lost or stolen.

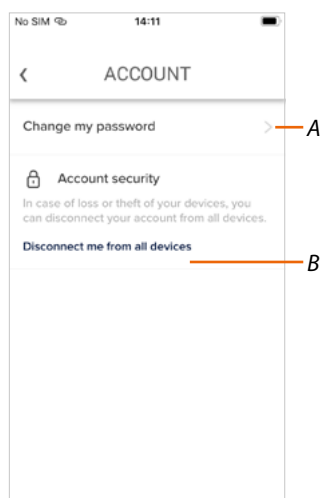

A Complete the password change procedure

B Disconnect from all devices

## Change the password

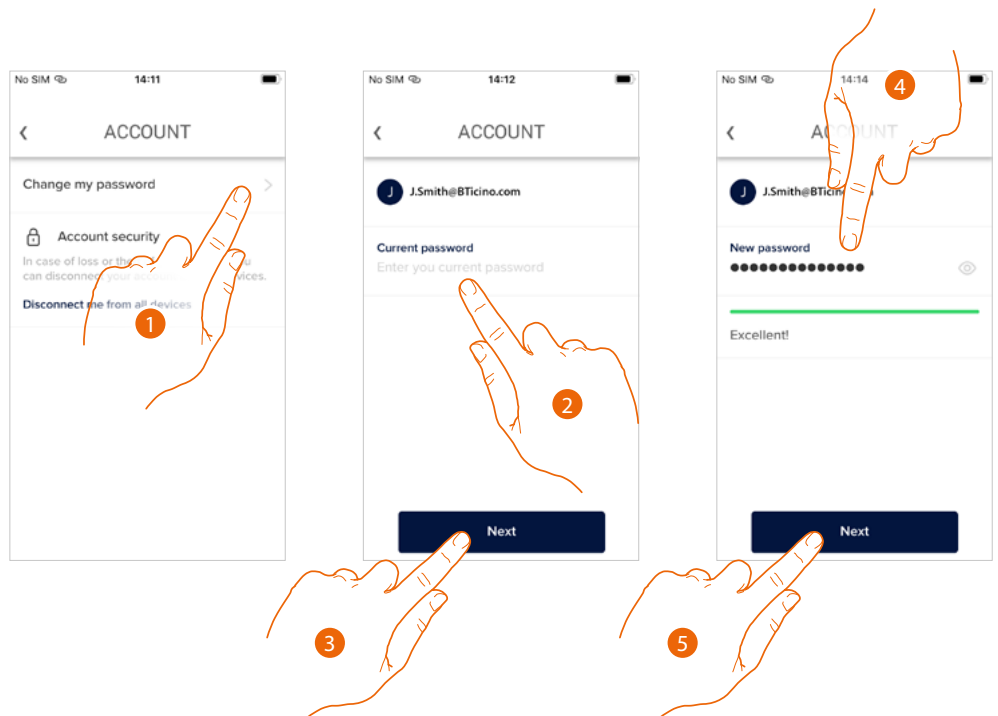

1. Touch to change the password
2. Enter the current password
3. Touch to continue.
4. Enter the new password, which must meet the following requirements:
  - at least 8 characters;
  - at least one lower case letter (e.g. a);
  - at least one upper case letter (e.g. A);
  - at least one number (e.g. 1);
  - at least one special character (e.g. \$);
5. Touch to confirm

### Disconnect from all devices

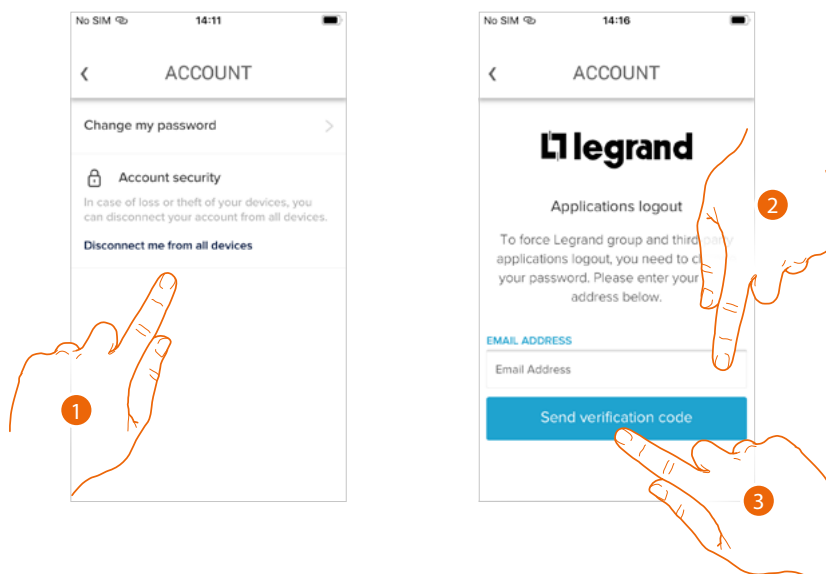

1. Touch to activate the procedure In order to disconnect your account from all devices, the password must be changed.
2. Enter the email address where the system can send a verification code
3. Touch to confirm the forwarding of the verification code

After confirming, the system will send a verification code to the e-mail address

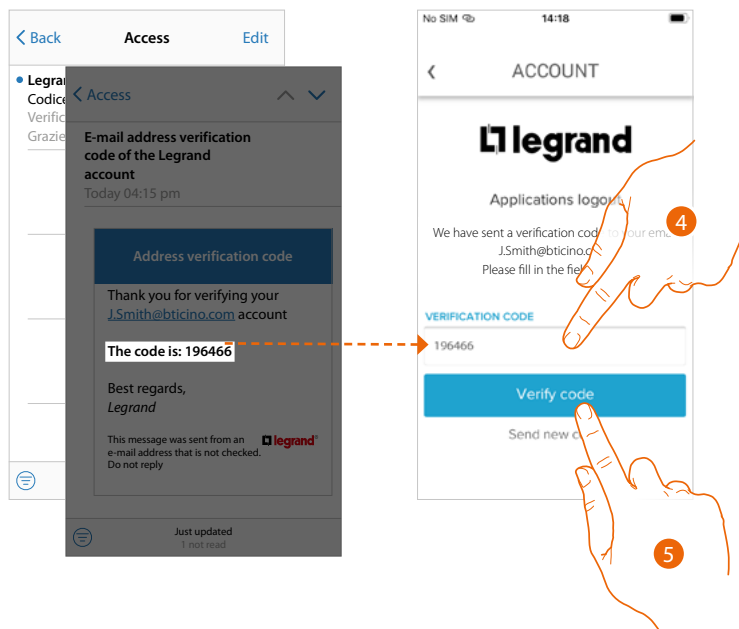

4. Enter the verification code received by e-mail
5. Touch to confirm

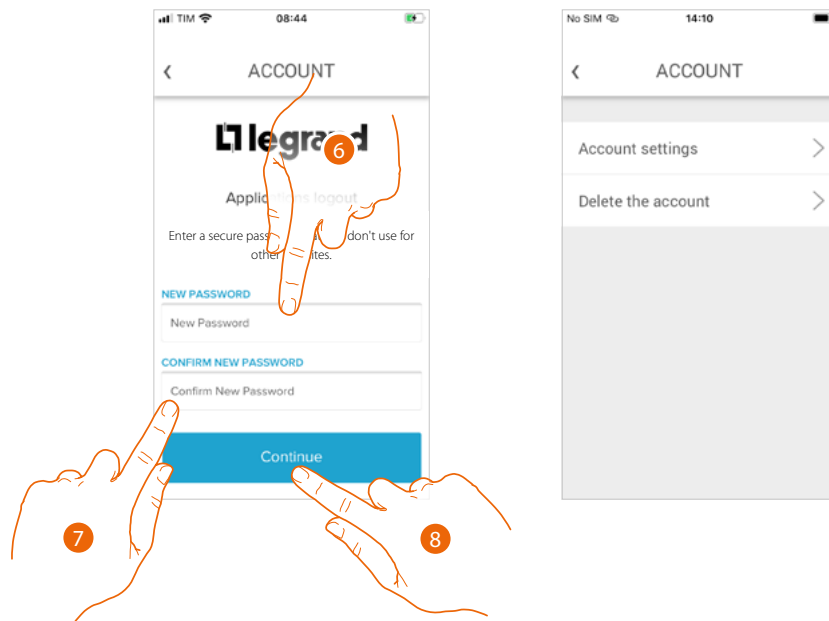

6. Enter the new password
  7. Re-enter it for confirmation
  8. Touch to continue
- Your account is now disconnected from all the devices to which it was associated.

### Authorisations

This section can be used to enable the reception of communications from Legrand and the sharing of the App usage data.

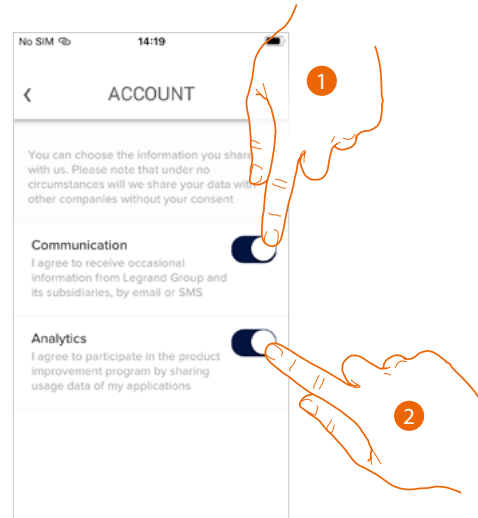

1. Touch to enable communications.
2. Touch to enable data sharing.

### Legal information

Using this section you will be able to view terms and conditions of use and privacy information for each App to which your Legrand account is associated

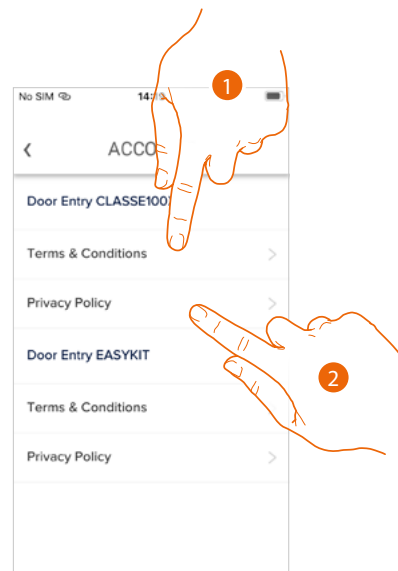

1. Touch to display Terms and Conditions
2. Touch to view Privacy information

## Partner apps

In this section you can display all the third parties to whom you granted rights to operate on your connected devices. (E.g.: Homekit, Google home etc.)

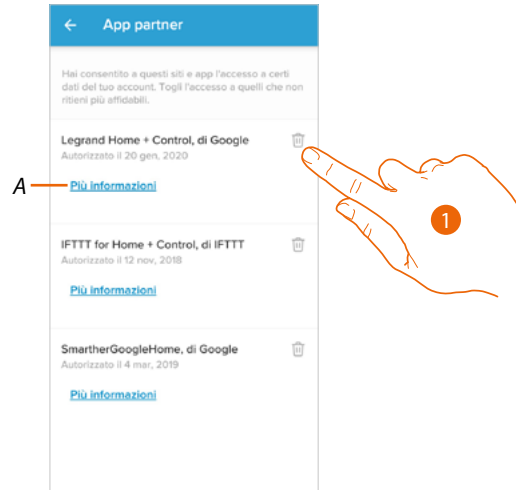

1. Touch to remove the access of sites or Apps to some of your account data
- A Display more information regarding the access to your system by partner Apps.

## Delete the account

This section can be used to permanently delete your Legrand account, which can therefore no longer be used for the Applications to which it was associated.

**Note:** when deleting your account, all the data associated with the Applications will also be lost.

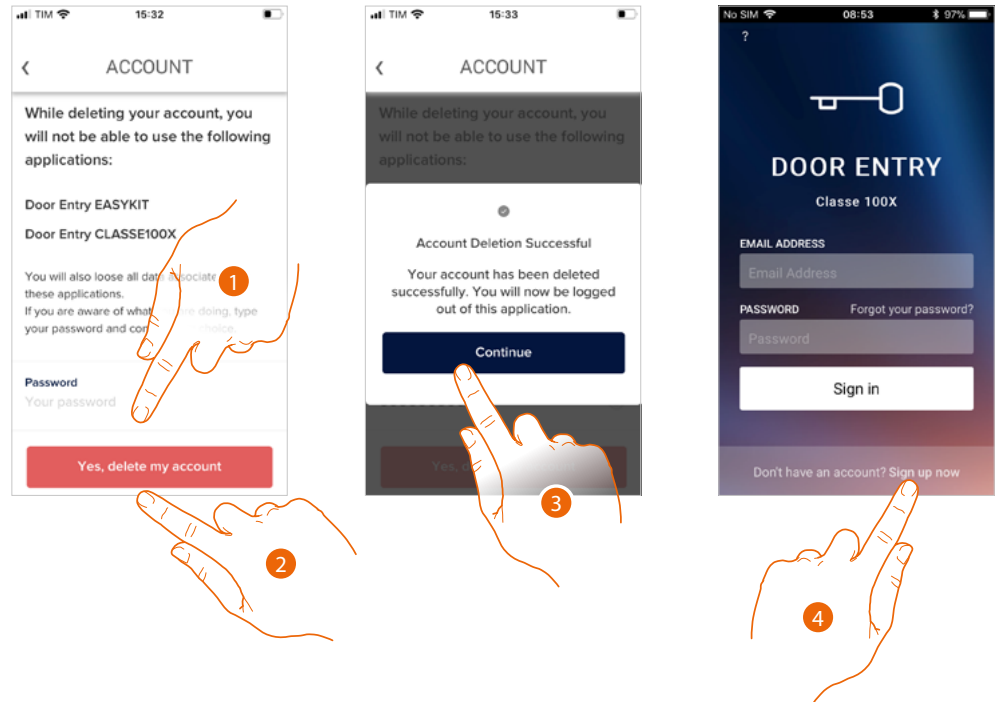

1. Enter the password
2. Touch to delete the account.
3. Touch to confirm
4. At the end of the procedure, the authentication page will allow you to complete a new registration.



## NETATMO cameras

In this section, it is possible to connect the Netatmo cameras of your system to the Door Entry CLASSE100X App.

In this way, you will be able to display the cameras both **from the device** and the **App**, and take advantage of the **Presence function** of the Netatmo control system.

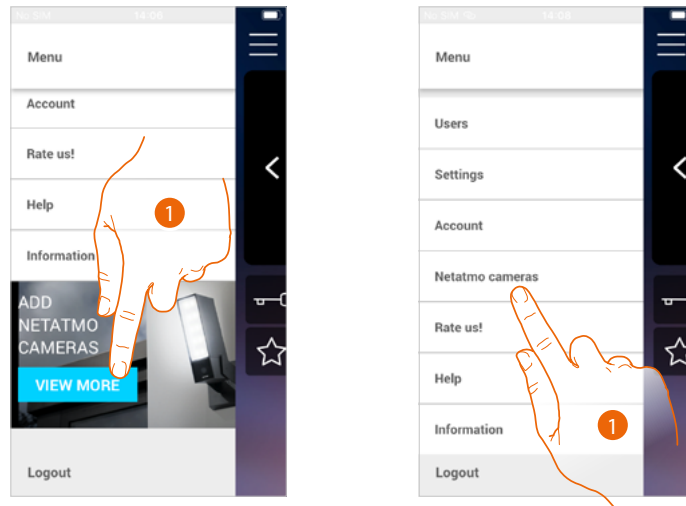

When opening the App for the first time, a banner will allow you to start the procedure for the connection of a Netatmo camera to the Door Entry CLASSE100X App. The banner will then disappear, and will be replaced by a menu item

1. Touch to add a camera

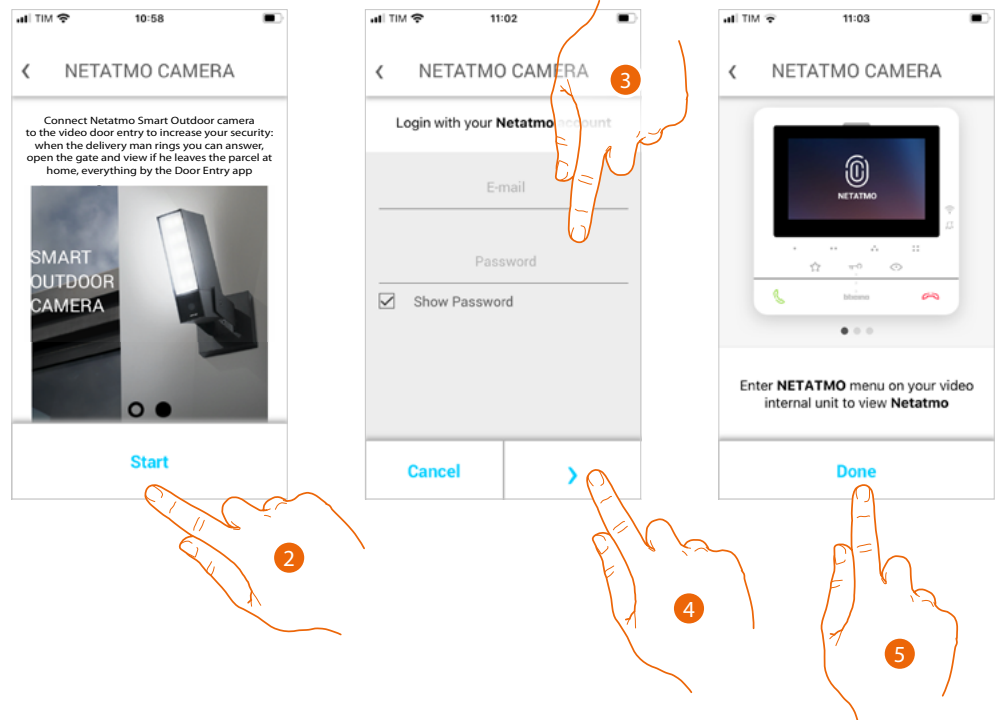

The display shows the cameras of the Netatmo range.

2. Touch to start the procedure
3. Enter your Netatmo account credentials
4. Touch to continue
5. Touch to confirm. It will now be possible to view the Netatmo cameras using the device

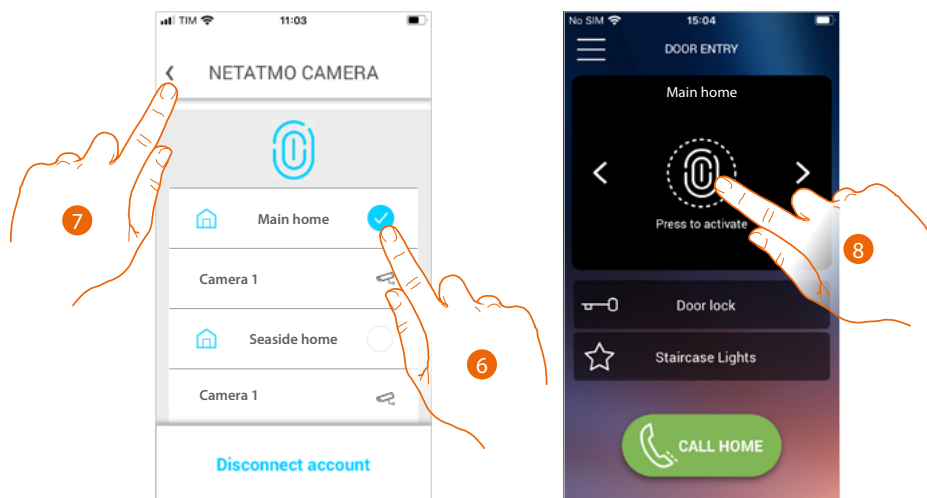

6. Select the home for which you wish to view the cameras in the home page
7. Touch to continue.
8. You can now use the home page to also view the Netatmo cameras of the previously selected home.

When viewing any 2 wires or Netatmo cameras, a "Presence" function allows you to know who is inside the home.

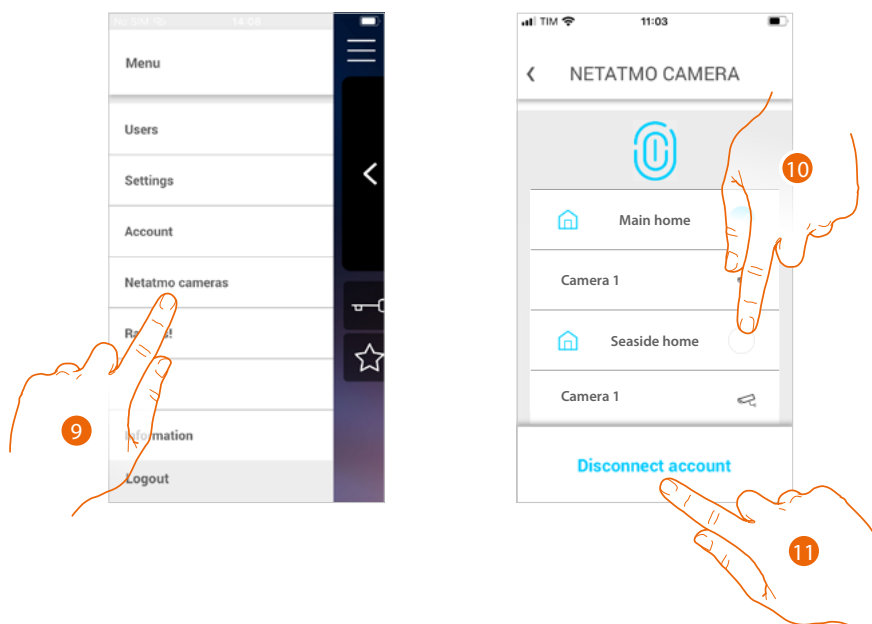

After the first association, touching the Netatmo Cameras in the drop-down menu will display the management page

9. Touch to display the page
- The page shows the homes in which Netatmo cameras are installed
10. Touch to change the home for which you wish to display the cameras
  11. Touch to disconnect the Netatmo account. The App will return to the conditions of item 1; repeat the procedure to connect the cameras



BTicino SpA  
Viale Borri, 231  
21100 Varese  
[www.bticino.com](http://www.bticino.com)

---