

Keor MOD RI

EN

ENGLISH

3

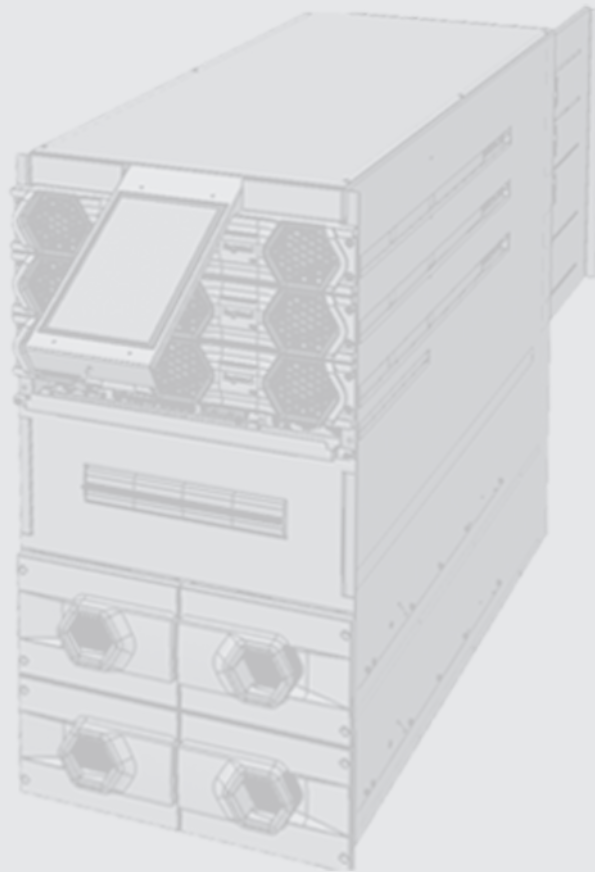

Table of Contents

1. Introduction	5
1.1 Overview	5
1.2 Purpose of the manual	5
1.3 Symbols in the manual	5
1.4 Where and how to keep the manual	6
1.5 Update of the manual	6
1.6 Manufacturer's liability and guarantee	6
1.6.1 Guarantee terms	6
1.6.2 Extension of the guarantee and maintenance contracts	7
1.7 Copyright	7
2. Regulatory and Safety requirements	8
2.1 General notes	8
2.2 Definitions of "Skilled Technician" and "Operator"	8
2.2.1 Skilled Technician	8
2.2.2 Operator	8
2.3 Personal Protective Equipment	8
2.4 Hazard signs in the workplace	9
2.5 Signs on the equipment	9
2.6 General warnings	10
2.7 How to proceed in an emergency	11
2.7.1 First-aid procedures	11
2.7.2 Fire procedures	11
3. Control panel	14
3.1 Synoptic area	14
3.1.1 Input line	15
3.1.2 Rectifier	16
3.1.3 Charger - Booster	16
3.1.4 Batteries	17
3.1.5 Inverter	17
3.1.6 Bypass	18
3.2 System area	19
3.3 Status bar	20
3.4 Menu bar	21
4. Operations	22
4.1 Switching ON the UPS	22
4.1.1 Power Module LED indication	23
4.2 Setting the UPS in forced bypass mode	23
4.3 Turning off the UPS	25
4.4 Display Sleep Mode	26
4.5 Loss of redundancy alarm	27
5. SSS Interface	28

Table of Contents

6. Installation and maintenance	29
6.1 Installation	29
6.2 Preventive maintenance	29
6.3 Periodical checks	29
6.4 Ordinary maintenance	29
6.5 Extraordinary maintenance	29
7. Warehousing	30
7.1 UPS 30	
7.2 Batteries	30
8. Dismantling	31
8.1 Battery disposal	31
8.2 UPS dismantling	31
8.3 Electronic component dismantling	31
9. Technical data	32

1. Introduction

1.1 Overview

LEGRAND is specialized in designing and producing UPS units. Keor MOD RI is unique in its kind: it is modular, redundant and belongs to the latest generation of high power UPS units.

High reliability, low running costs and excellent electrical performance are only some of its characteristics. The high quality standards of LEGRAND in design and production allows Keor MOD RI to pass the strictest quality tests.

The UPS has been designed in compliance with the existing European community directives, with the technical standards that include their requirements and with the eco-design guidelines.

The equipment is produced at an ISO14001 certified factory.

This publication, simply defined “user manual” herein, contains all the information for the use of the Keor MOD RI UPS, also referred to as “equipment” in this manual.

The contents of the user manual are intended mainly for an operator (see paragraph 2.2.2) or for people, generically defined as “users”, who have the need and/or obligation to provide instructions or work directly on the equipment for their assigned tasks.

These people can be the following:

- managers;
- heads of operating areas;
- department heads;
- direct private users.

1.2 Purpose of the manual

The purpose of this manual is to provide the operator with instructions for safely using the equipment after the installation performed by a skilled technician.

Extraordinary maintenance operations are not dealt with because they are the sole preserve of the LEGRAND Technical Support Service.

The reading of this manual is essential but does not substitute the skill of technical personnel who must have received adequate preliminary training.

The intended use and configurations envisaged for the equipment as shown in this manual are the only ones allowed by the Manufacturer.

Any other use or configuration must be previously agreed with the Manufacturer in writing and, in this case, the written agreement will be attached to the installation and user manuals.

This manual also refers to laws, directives and standards that the skilled technician is required to be aware of and consult.

The original text of this publication, drafted in English, is the only reference for the resolution of disputes of interpretation linked to translations into other languages.

1.3 Symbols in the manual

Some operations are shown in graphic symbols that draw the attention of the reader to the danger or the importance they imply:



DANGER

This indication shows a danger entailing a high degree of risk that, if not avoided, will lead to death or serious injury or considerable damage to the equipment and things around it.



WARNING

This indication shows a danger entailing a medium degree of risk that, if not avoided, could lead to death or serious injury or considerable damage to the equipment and the things around it.



CAUTION

This indication shows a danger entailing a low level of risk that, if not avoided, could lead to minor or moderate injury or material damage to the equipment and the things around it.

1. Introduction

INDICATION

This symbol indicates important information which should be read carefully.

1.4 Where and how to keep the manual

This manual must be kept in a safe, dry place and must always be available for consultation.

It is recommended to make a copy of it and file it away.

If information is exchanged with the Manufacturer or the authorized assistance personnel, it is essential to refer to the equipment's rating plate data and serial number.

INDICATION

The manuals provided with the equipment are an integral part of it and must therefore be kept for its entire lifetime. In case of need (for example in case of damage that even partially compromises its consultation) the operator is required to get a new copy from the Manufacturer, quoting the publication code on the cover.

1.5 Update of the manual

The manual reflects the state of the art when the equipment was put onto the market. The publication conforms to the directives current on that date. The manual cannot be considered inadequate when new standards come into force or modifications are made to the equipment.

Any addition to the manual the Manufacturer considers appropriate to send to the users, must be kept together with the manual of which they will become an integral part.

The version of the manual updated to its latest release is available on the Internet at <https://ups.legrand.com>

1.6 Manufacturer's liability and guarantee

The skilled technician and the operator shall scrupulously comply with the precautions and installation instructions indicated in the manuals. They must:

- always work within the operating limits of the equipment;
- always carry out constant and careful maintenance through a skilled technician who complies with all the procedures indicated in the installation and maintenance manual.

The Manufacturer declines all indirect or direct responsibility arising from:

- assembly and cabling made by personnel not fully qualified according to national standards to work on equipment presenting electrical hazards;
- assembly and cabling made without using safety equipment and tools required by national safety standards;
- failure to observe the installation and maintenance instructions and use of the equipment which differs from the specifications in the manuals;
- use by personnel who have not read and thoroughly understood the content of the user manual;
- use that does not comply with the specific standards used in the country where the equipment is installed;
- modifications made to the equipment, software, functioning logic unless they have been authorized by the Manufacturer in writing;
- repairs that have not been authorized by the LEGRAND Technical Support Service;
- damage caused intentionally, through negligence, by acts of God, natural phenomena, fire or liquid infiltration;
- damage caused using batteries and protections not specified in the manuals;
- accidents caused by a wrong assembly of the safety protections or due to the lack of application of the safety labels specified in the installation manual.

The transfer of the equipment to others also requires to hand over all the manuals. Failure to do it will automatically nullify any right of the buyer, including the terms of the guarantee where applicable.

If the equipment is sold to a third party in a country where a different language is spoken, the original owner shall be responsible for providing a faithful translation of this manual in the language of the country where the equipment will be used.

1.6.1 Guarantee terms

The guarantee terms may vary depending on the country where the UPS is sold. Check the validity and duration with LEGRAND's local sale representative.

If there should be a fault in the product, contact the LEGRAND Technical Support Service which will provide all the instructions on what to do.

Do not send anything back without LEGRAND's prior authorization.

The guarantee becomes void if the UPS has not been brought into service by a properly trained skilled technician (see paragraph 2.2.1).

If during the guarantee period the UPS does not conform to the characteristics and performance laid down in this manual, LEGRAND at its discretion will repair or replace the UPS and relative parts.
All the repaired or replaced parts will remain LEGRAND's property.

LEGRAND is not responsible for costs such as:

- losses of profits or earnings;
- losses of equipment, data or software;
- claims by third parties;
- any damage to persons or things due to improper use, unauthorized technical alterations or modifications;
- any damage to persons or things due to installations where the full compliance with the standard regulating the specific usage applications have not been guaranteed.

1.6.2 Extension of the guarantee and maintenance contracts

The standard guarantee can be consolidated in a single extension contract (maintenance contract).

Once the guarantee period has passed, LEGRAND is available for giving a technical assistance service able to meet all requirements, maintenance agreements, 24/7 availability and monitoring.

Please, contact the LEGRAND Technical Support Service for further information.

1.7 Copyright

The information contained in this manual cannot be disclosed to any third party. Any partial or total duplication of the manual by photocopying or other systems, including electronic scanning, which is not authorized in writing by the Manufacturer, violates copyright conditions and may lead to prosecution.

LEGRAND reserves the copyright of this publication and prohibits its reproduction wholly or in part without previous written authorization.

2. Regulatory and Safety requirements



Before carrying out any operation on the equipment, it is necessary to read the entire manual carefully, especially this chapter.

Look after this manual carefully and consult it repeatedly during installation and maintenance by a skilled technician.

2.1 General notes

The equipment has been made for the applications given in the manual. It may not be used for purposes other than those for which it has been designed, or differently from those specified in this manual.

The various operations must be carried out according to the criteria and the chronology described in this manual.

2.2 Definitions of "Skilled Technician" and "Operator"

2.2.1 Skilled Technician

The figure that will carry out the installation, start up and ordinary maintenance is called "Skilled Technician".

This definition refers to people who have the specific technical qualification and are aware of the method of installing, assembling, repairing, bringing online and using the equipment safely.

In addition to the requirements listed in the section below for a general operator, the Skilled Technician is qualified according to national safety standards to work under dangerous electrical voltage and uses the personal protective equipment required by national safety standards for all the operations indicated in this manual (see the examples listed in paragraph 2.3).

INDICATION

The safety manager is responsible for protection and company risks prevention according to what is indicated in European directives 2007/30/EC and 89/391/EEC regarding safety in the workplace.

The safety manager must ensure that all the people working on the equipment have received all the instructions concerning them in the manual, especially those contained in this chapter.

2.2.2 Operator

The figure assigned to the equipment for normal use is called "Operator".

This definition refers to people who know how to operate the equipment defined in the user manual and have the following requisites:

1. technical education, which enables them to operate according to safety standards in relation to the dangers linked to the presence of electric current;
2. training on the use of personal protective equipment and basic first aid interventions.

The company safety manager, in choosing the person (operator) who uses the equipment, must consider

- the person's work fitness according to the laws in force;
- the physical aspect (not disabled in any way);
- the psychological aspect (mental stability, sense of responsibility);
- the educational background, training and experience;
- the knowledge of the standards, regulations and measures for accident prevention.

He shall also provide training in such a way as to provide thorough knowledge of the equipment and its component parts.

Some typical activities the operator is expected to carry out are:

- the use of the equipment in its normal functioning state and the restore of the functioning after it shuts down;
- the adoption of the necessary provisions for maintaining the quality performance of the UPS;
- the cleaning of the equipment;
- cooperation with personnel responsible for ordinary maintenance activities (Skilled Technicians).

2.3 Personal Protective Equipment



The UPS poses a considerable risk of electric shocks and a high short circuit current. During installation, use and maintenance operations, the equipment mentioned in this section must be used.

People responsible for operating this equipment and/or passing close to it must not wear garments with flowing sleeves, nor may laces, belts, bracelets or other metal pieces that might cause a danger.

The following list sum up the minimum Personal Protective Equipment to wear always. Additional requirements may be needed according to national safety standards.



Anti-accident and non-sparking shoes with rubber sole and reinforced toe



Protective gloves for handling operations



Isolated rubber gloves for operations of connection and work under hazardous voltage



Protective garments for electrical work



Protective face and head shield



1000 V Isolated tools

INDICATION

The skilled technician must work on electrical insulated carpet and he must not wear any kind of metal objects like watches, bracelets, etc.

2.4 Hazard signs in the workplace

The following signs must be exhibited at all points of access to the room where the equipment is installed:



Electric current
This sign indicates the electrical live parts.



How to proceed in an emergency
Do not use water to quench fires but just the extinguishers specially designed for putting out fires in electrical equipment.



No smoking
This sign indicates that smoking is not allowed.

2.5 Signs on the equipment

Displayed on the UPS are explanatory plates that can vary depending on the country the equipment is intended for and constructional standards applied.

Make sure the instructions are adhered to. Removing these plates and working in a way that differs from what written there, is strictly prohibited.

The plates must always be clearly read and they must be cleaned periodically.

If a plate deteriorates and/or it is no longer legible, even partially, the Manufacturer must be contacted for another one.



CAUTION

The plates must not be removed or covered. Signs in different languages are provided along with the equipment to replace those in English. No other plates may be affixed to the equipment without the Manufacturer's prior written authorisation

2. Regulatory and Safety requirements

WARNING

Potential risks can be drastically reduced by wearing the Personal Protective Equipment listed in this chapter, which are indispensable. Always operate with due care around dangerous areas marked by the appropriate warning notices on the equipment.

2.6 General warnings

DANGER

The UPS works with dangerous voltages. Only Skilled Technicians must perform the installation and ordinary maintenance operations. No part of the UPS can be repaired by the operator.

Extraordinary maintenance operations must be carried out by LEGRAND Technical Support Service personnel.

DANGER

Before beginning any installation and/or maintenance operation, make sure that all the DC and AC power sources are disconnected.

The UPS and the external battery cabinet, if present, must be installed with an earth connection to avoid high leakage currents. First connect the earthing cable.

Check during each installation and/or maintenance operation the continuity of the earthing system.

DANGER

The UPS is powered by its own DC energy source (batteries). The output terminals may have a dangerous voltage even if the UPS is not connected to the AC power network.

Disconnect all battery drawers and external battery cabinets before performing any installation and/or maintenance operation.

WARNING

A battery can present a risk of electrical shock and burns by high short-circuit current. Failed batteries can reach temperatures that exceed the burn thresholds for touchable surfaces. The following precautions should be observed when working on batteries:

- a) remove watches, rings or other metal objects.
- b) use tools with insulated handles.
- c) wear rubber gloves and boots.
- d) do not lay tools or metal parts on top of batteries.
- e) disconnect the charging source prior to connecting or disconnecting battery terminals.
- f) determine if battery is inadvertently grounded. If inadvertently grounded, remove source from ground.
Contact with any part of a grounded battery can result in electrical shock. The likelihood of such shock can be reduced if such grounds are removed during installation and maintenance (applicable to equipment and remote battery supplies not having a grounded supply circuit).
- g) never leave live cable terminals without an insulated protection.
- h) When replacing batteries, replace with the same type and number of batteries or battery packs. There is the risk of explosion if batteries are replaced by an incorrect type.

Do not dispose of batteries in a fire. The batteries may explode.

Do not open or mutilate batteries. Released electrolyte is harmful to the skin and eyes. It may be toxic. The batteries installed inside the cabinet must be disposed of correctly. For the disposal requirements refer to local laws and relevant standards.

INDICATION

The UPS functions with TT, IT, TN-C and TN-S systems. Input and output neutral are referenced to the same neutral potential: the output neutral status is the same as the input neutral status.

When the output load needs a different neutral status, it is necessary to place downstream of the UPS a suitably scaled isolation transformer that must be protected in compliance with the standards in force.

CAUTION

Do not open the battery fuse holders while the UPS is powering the loads in battery mode.

 **WARNING**

To reduce the risk of fire or electric shock, the UPS must work in closed, clean environments with controlled temperature and humidity. It must be kept away from inflammable liquids and corrosive substances. The room temperature must not be above +40°C (+104°F) and the relative humidity must be a maximum of 95% not condensing.

INDICATION

The equipment generates, uses and can radiate radio frequency energy. If it is not installed and used in accordance with the instructions, it may cause harmful interference with radio communications.

Keor MOD RI is a category C3 UPS according to the standard EN62040-2

The UPS can be used in commercial and industrial environments; nevertheless, restrictions or adequate countermeasures might be necessary to avoid radio interference.

 **CAUTION**

- The equipment must be maintained and used according to the instructions of this manual.
- The departmental manager must instruct the operating and maintenance personnel on the safe use and maintenance of the equipment.
- Only specifically-trained, highly skilled personnel are allowed access to the equipment in order to perform maintenance. While the maintenance operation is being carried out, signs saying "Maintenance work in progress" must be affixed in the department in such a way that they can be easily seen from any access area.
- The connection of the equipment (and of any accessory devices) must always be perfectly grounded to discharge short-circuit currents and electrostatic voltages. The input voltage must correspond with the value shown on the rating plate. Current adapters must not be used under any circumstances. Pay attention to polarity when connecting.
- Any intervention on the equipment must be done only after it has been disconnected from the power supply network by means of a switch disconnecter and must be locked with an appropriate padlock.
- The UPS must not be turned on if liquid is leaking from the batteries.
- The equipment used for any maintenance operations (pliers, screwdrivers etc.) must be electrically insulated.
- Depositing flammable material near the equipment is strictly forbidden. The equipment should always be locked, and only specifically trained personnel are allowed access to it.
- Do not disable any safety, notification or warning device and do not ignore any alarm, warning message or notice, no matter whether they are generated automatically or represented by plates fixed to the equipment.
- Do not run the equipment with fixed protections not installed (panels etc.).
- In case of breaking, buckling or malfunctioning of the equipment or parts of it, repair or replace immediately.
- For no reason can the structure of the equipment, the devices mounted on it, the operation sequence etc., be modified, manipulated or tampered with in any way, without prior consultation with the Manufacturer.
- When replacing fuses, only use ones of the same type.
- The replacement of the batteries is an operation intended to be carried out by a skilled technician.
- Keep a register in which to enter the date, time, type, performer's name and any other useful information about each and any routine and extraordinary maintenance operation.
- Do not use oils or chemical products for cleaning because they could scratch, corrode or damage certain parts of the equipment.
- The equipment and workplace must be kept completely clean.
- Upon completion of the maintenance operations, before connecting the power supply, carefully check that no tools and/or material of any kind have been left next to the equipment.

INDICATION

The skilled technician must not leave at the disposal of the operator:

- the keys for opening the rack cabinet;
- the installation and maintenance manual.

2.7 How to proceed in an emergency

The following information are general. For the specific interventions consult the regulations in force in the country where the equipment is installed.

2.7.1 First-aid procedures

When administering first aid, adhere to the company rules and the usual procedures.

2.7.2 Fire procedures

Do not use water to quench fires but just the extinguishers specially designed for putting out fires on electrical equipment.

3. Control panel

 **WARNING**

The control panel allows to change some functional settings of the UPS.
Only a skilled technician (paragraph 2.2.1) is authorized to modify the configuration set during the installation. Wrong settings could lead to injury or material damage to the equipment and the things around it.

The control panel is made up of a 10" touch-screen colored display that must be pulled out from his drawer.

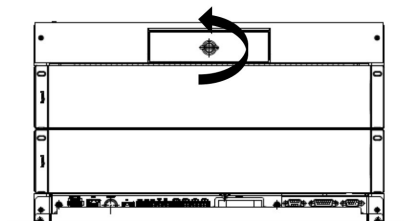
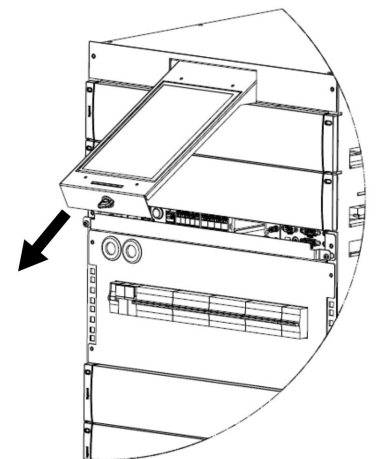
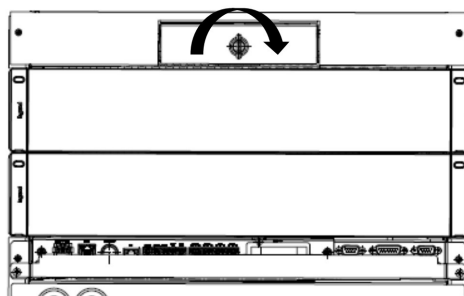

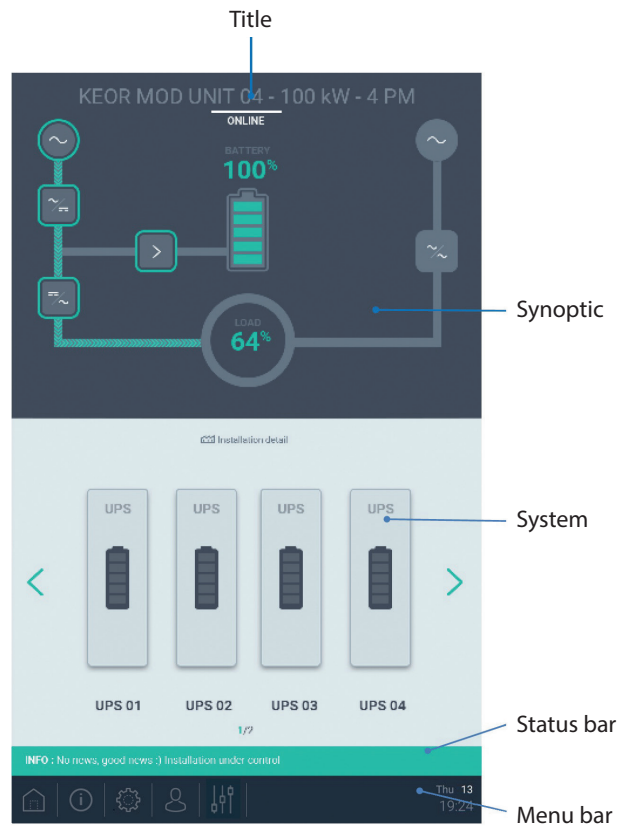

Each screen is made up by five parts:

- TITLE: it describes the element selected in the bottom area (SYSTEM);
 - "System": the page shows the system view;
 - "UPS name": the page shows the UPS view;
 - "UPS name / Module name": the page shows the UPS modules.
- SYNOPTIC (top area): it includes details of the element selected in the bottom area.
- SYSTEM (bottom area): it shows all the UPS that make up the system and each UPS Status Bar. The user can navigate through the modules that build up each UPS.
- UPS STATUS BAR: it shows the status of the UPS installed on the selected cabinet.
- MENU BAR: it contains links to other sections such as the system view, service, settings, log in, traditional menu, date and time and actions control.

3. Control panel

3.1 Synoptic area

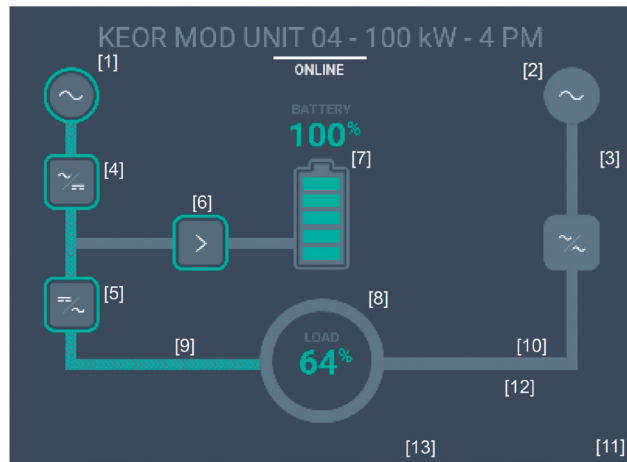





The SYNOPTIC area is strictly connected to the SYSTEM area. It shows the details of what is selected in the bottom area. The SYNOPTIC may include the following blocks:

- [1] - [2] Input
- [3] Bypass
- [4] Rectifier
- [5] Inverter
- [6] Booster-charger
- [7] Batteries
- [8] Output-Load rate: the minimum load rate displayed is 5%. If the load rate is inferior, the value is not shown.
- [9] Active flow
- [10] Inactive flow
- [11] Fan icon
- [12] Mute alarm icon
- [13] Temperature icon

It is possible to see which blocks are active or not by the graphical flow indication:

	DESCRIPTION
	Active flow
	Inactive flow





When an icon in the SYNOPTIC area is tapped, a popup window is displayed close to the icon. The popup window contains 4 elements:

	DESCRIPTION
	Measurements
	Settings
	Historical data
	Additional info

By tapping on one of these elements, a new popup window with more details is displayed in the SYSTEM area.

3.1.1 Input line





The icons regarding the input line are the following ones:

	INPUT ICON COLOR	DESCRIPTION
	Fixed light white icon and green stroke	The input line is present. Normal behavior.
	Fixed dark grey icon	The input line is not present
	Flashing light yellow icon	Some warnings of medium gravity are occurring
	Flashing light red icon	Some warnings of high gravity are occurring

3. Control panel









3.1.2 Rectifier

The icons regarding the rectifier are the following ones:

	RECTIFIER ICON COLOR	DESCRIPTION
	Fixed light white icon and green stroke	The rectifier is active. Normal behavior.
	Fixed dark grey icon	The rectifier is not active
	Flashing light yellow icon	Some warnings of medium gravity are occurring
	Flashing light red icon	Some warnings of high gravity are occurring





3.1.3 Charger - Booster

The icons regarding the charger and the booster are the following ones:

		CHARGER-BOOSTER ICON COLOR	DESCRIPTION
		Fixed light white icon and green stroke	The charger is active. Normal behavior.
		Fixed dark grey icon	The charger is not active
		Flashing light yellow icon	Some warnings of medium gravity are occurring
		Flashing light red icon	Some warnings of high gravity are occurring

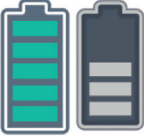
3.1.4 Batteries





The icons regarding the batteries are the following ones:

	BATTERIES ICON COLOR	DESCRIPTION
	Fixed light grey icon	Normal behavior. The LED bar indicates the level of charge.
	Fixed dark grey icon	The batteries are not present/active
	Flashing light yellow icon	The level of charge is low
	Flashing light red icon	Some warnings of high gravity are occurring

The batteries icon does not open any popup window with data and information.

3.1.5 Inverter





The icons regarding the inverter are the following ones:

	INVERTER ICON COLOR	DESCRIPTION
	Fixed light white icon and green stroke	The rectifier is active.
	Fixed dark grey icon	The rectifier is not active
	Flashing light yellow icon	Some warnings of medium gravity are occurring
	Flashing light red icon	Some warnings of high gravity are occurring

3. Control panel





3.1.6 Bypass

The icons regarding the bypass are the following ones:

	BYPASS ICON COLOR	DESCRIPTION
	Fixed light white icon and green stroke	The bypass is active
	Fixed dark grey icon	The bypass is not active
	Flashing light yellow icon	Some warnings of medium gravity are occurring
	Flashing light red icon	Some warnings of high gravity are occurring





3.2 System area

The icons regarding the UPS are the following ones:

	UPS ICON COLOR	DESCRIPTION
	Light grey	The UPS is active. Normal behavior.
	Dark grey	The UPS is inactive or switched off.
	Yellow	Some warnings are occurring: the corresponding UPS Status Bar becomes yellow and the text explains the situations of warning.
	Red	The UPS has serious problems (alarm): the corresponding UPS Status Bar becomes red and the text explains the situations causing the alarm. In the synoptic area, the involved icons light up red.

3. Control panel

The icons regarding the power modules are the following ones:

	PM ICON COLOR	DESCRIPTION
	Roundish rectangular with a pale grey filling	PM absent
	Roundish rectangular with three fan icons inside	PM present
	Roundish rectangular with a pale blue filling	PM in stand-by
	Roundish rectangular with a pale yellow filling	Warnings related to the PM
	Roundish rectangular with a pale red filling	PM with alarms

3.3 Status bar

The Status Bar is a graphical line that describes the actual status of the UPS.

It can assume different states and sizes:





- Green and thin lane: normal situation (no alarm neither warning)
- Yellow and thin lane with text: warning is occurring. The text explains the warning.
- Red and bigger lane with text: alarm is occurring. The text explains the alarm.

3.4 Menu bar

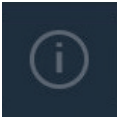

The menu bar, at the bottom of the interface, contains the section icons related to:

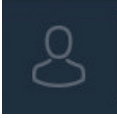
- [1] UPS View
- [2] Info
- [3] Settings
- [4] Login
- [5] General Commands
- [6] Date

	ITEM	DESCRIPTION
	UPS View	Open the UPS view (main screen)
	Info	General info of the HW and SW
	Settings	Set the System Mode and its options. It can also show the login popup for some special settings.
	Login	Open the login popup and the keyboard. Two level access: user ID and password
	General Commands	

4. Operations

4.1 Switching ON the UPS

1. Insert the battery fuses into the appropriate fuse breakers of the external battery cabinets (if present).
2. Press for at least 5 seconds the COLD START button of the SSS interface. The display turns on and the UPS boot starts. The UPS boot ends when the LEDs on the power modules turn to steady blue.
3. Provide the mains supply to the UPS by closing the external mains input/bypass input disconnectors (ON position).
4. Tap on the *General Command* icon of the menu bar at the bottom of the display.



5. Tap on the icon > of the item *COMMANDS*

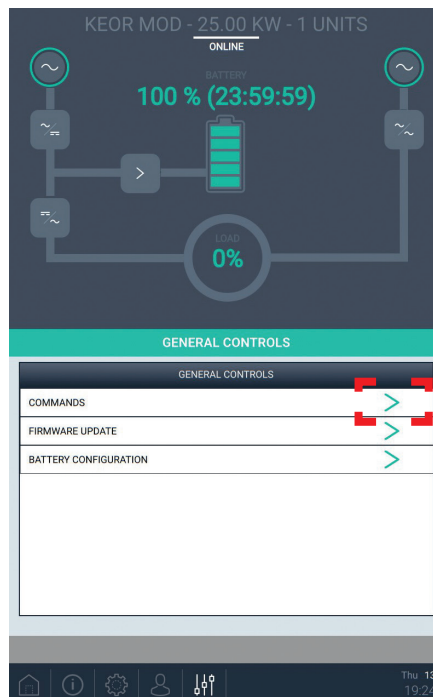

- Tap on the *ON* button of the item *System Power On*.

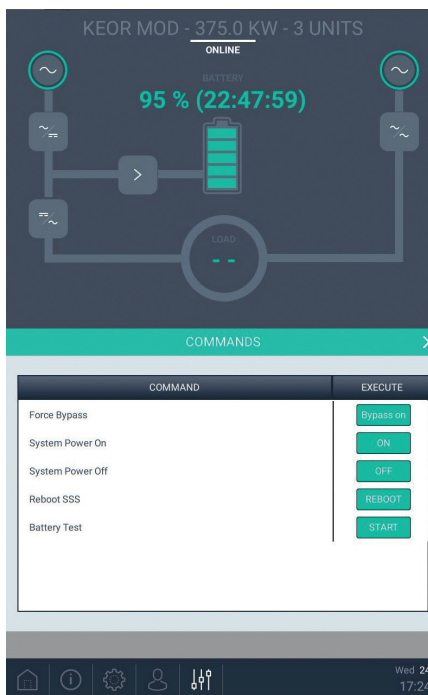





- The LEDs on the power modules turn to steady yellow while they are powered from the batteries. When they are powered from the mains and the UPS is on-line, the LEDs turn to steady green.
- Provide the power supply to the load by closing the external output disconnector (ON position).

INDICATION

If the UPS is in battery mode and runs to the end of autonomy, it will turn to bypass mode if the bypass is present. If the bypass is not present, the UPS goes to stand-by mode.

4.1.1 Power Module LED indication

Each color shown by the LED bar of the power modules indicates the status of the UPS:

	PM LED color	Description
	steady GREEN	UPS in Normal mode. The input line is present
	steady ORANGE	UPS in Battery mode
	blinking ORANGE	UPS in Bypass mode
	steady BLUE	UPS in Stand-by mode
	steady RED	Alarm on the PM

4.2 Setting the UPS in forced bypass mode

- Tap on the *Settings* icon of the menu bar at the bottom of the display.



4. Operations

2. Check on the tab *System* that the item *Bypass Enable* is set to YES. If not, tap on the item and enable the bypass.

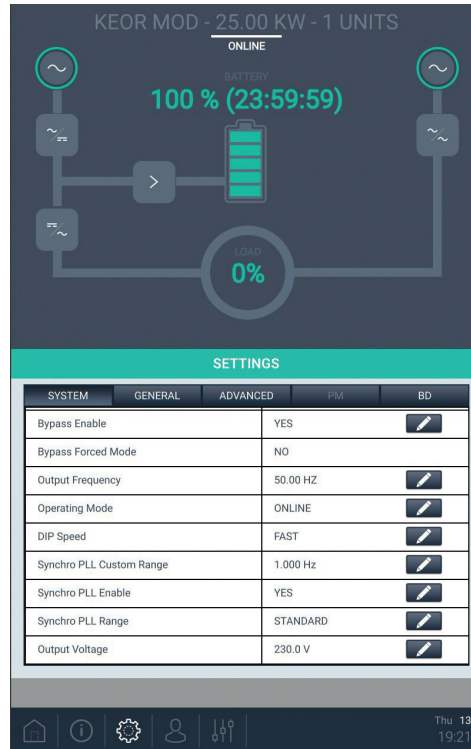

3. Tap on the *General Commands* icon of the menu bar at the bottom of the display.



4. Tap on the icon > of the item *COMMANDS*.

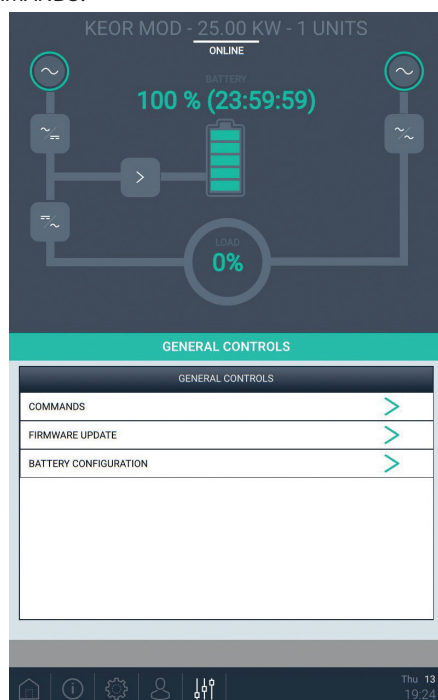

- Tap then on the *Bypass ON* button of the item *Force Bypass*. The LEDs of the PM blink fast in orange.

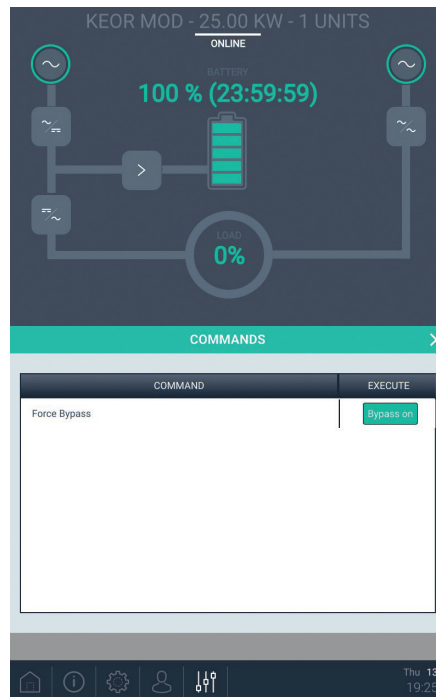

4.3 Turning off the UPS

- Tap on the *General Commands* icon of the menu bar at the bottom of the display.
- Then locate the item *System Power Off* and tap on the button *OFF* to turn off the UPS.

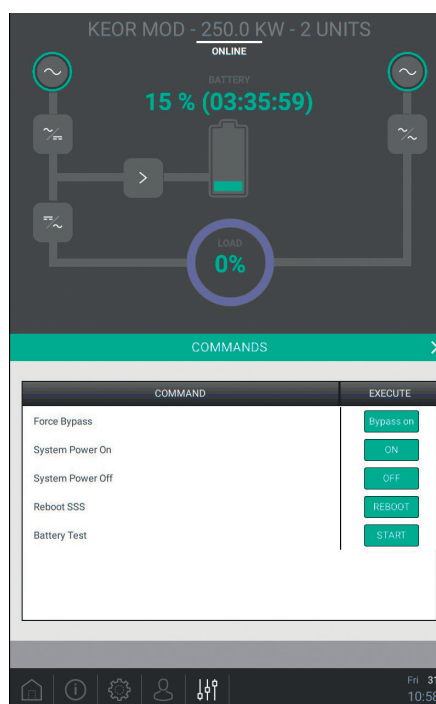

- The LEDs on the power modules turn to steady blue when they are in stand-by mode and the UPS is no longer supplying the load

4. Operations

DANGER

In this stand-by condition there are still hazardous voltages on the UPS.

To disconnect the UPS from all sources of supply:

- open the external mains input/bypass input disconnectors (ON position);
- open all the fuse breakers of the external battery cabinets (if present);
- remove at least one battery drawer for every shelf present to interrupt the battery string.

4.4 Display Sleep Mode

It is possible to automatically turn off the display after 30 minutes from the last touch. The default setting is to keep the display always on. To enable the display sleep mode:

1. Tap on the *Setting* icon of the menu bar at the bottom of the display.



2. Tap on the GENERAL tab.
3. Tap on the *Pencil* icon of the item *Display Sleep Mode*.
4. Tap on the *ON* button and then on the *CONFIRM* button.

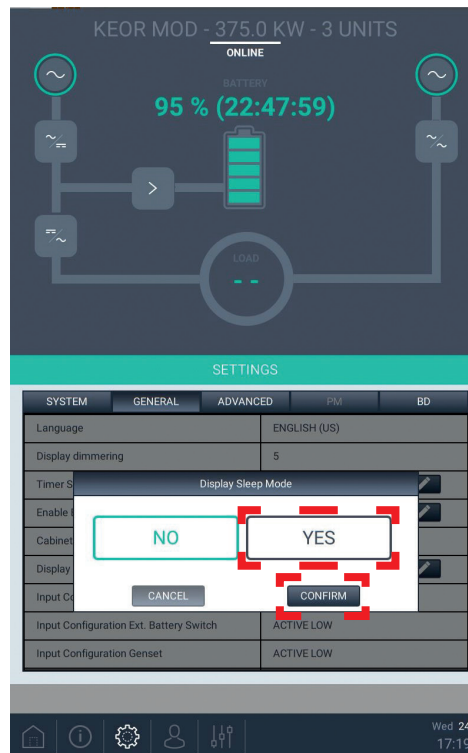

4.5 Loss of redundancy alarm

The UPS has a modular architecture. It can be configured as an N+x redundant simply by choosing a proper number of power modules to be installed in the UPS cabinet. Each module is rated for N capacity and share the load. If the load remains at or below N, the system is redundant. Even in the case of a fault in one or more modules, the equipment continues to function avoiding any downtime.

It is possible to set an alarm in case of loss of redundancy. To enable it:

- 1. The UPS must be in stand-by mode.
- 2. Tap on the *Setting* icon of the menu bar at the bottom of the display.



- 3. Tap on the *SYSTEM* tab.
- 4. Tap on the *Pencil* icon of the of the item *PM redundancy*.

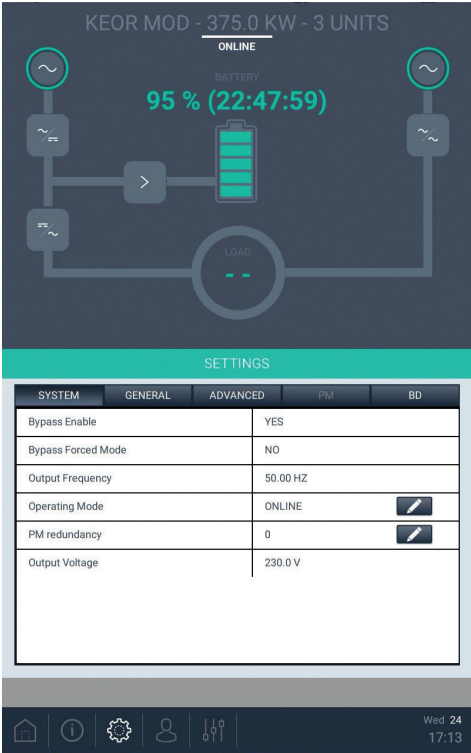

- 5. Select the number of modules more than needed to power the load N. The default value is 0 and the number can be set up to 3.

5. SSS Interface

The UPS is equipped with an SSS interface (Supervisor Sub System Interface).

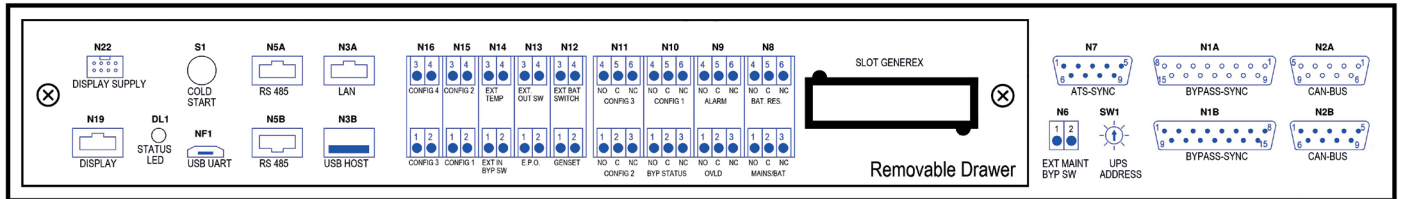

This interface includes:

- terminals for connecting the EPO (Emergency Power Off button);
- 8 outputs contacts to be set NC or NO by display;
- 10 input contacts to be set NC or NO by display;
- slot for an SNMP interface that allows the UPS diagnostics, remote control via the network and computer remote shut-down within the battery runtime;
- USB HOST port for firmware updates;
- USB UART port for maintenance purposes;
- an input contact GENSET which allows the UPS to know if there is an external generator.

The cabling must be performed by a skilled technician according to the instructions given in the installation manual.

6. Installation and maintenance



DANGER

INSTALLATION and ORDINARY MAINTENANCE operations must be carried out only by SKILLED TECHNICIANS (paragraph 2.2.1).

EXTRAORDINARY MAINTENANCE operations must be carried out only by LEGRAND TECHNICAL SUPPORT SERVICE.

6.1 Installation

The operator (paragraph 2.2.2) is not authorized to install and connect electrically the UPS. These operations are the sole preserve of a skilled technician (paragraph 2.2.1) who must follow the instructions addressed to him in the installation and maintenance manual.



DANGER

The operator is not authorized to carry out the activities listed in the installation and maintenance manual.

LEGRAND declines all liability for any injury or damage caused by activities carried out differently from the instructions written in this manual or by a skilled technician who does not follow the requirements written in the installation and maintenance manual.

6.2 Preventive maintenance

The UPS does not contain parts for preventative maintenance by the operator.

The operator must regularly perform:

- a general external cleaning;
- a check to verify there is no alarm indication on the display;
- a check to verify the correct functioning of the ventilating fans on each power module.

6.3 Periodical checks

The correct functioning of the UPS must be guaranteed by periodical maintenance inspections. These are essential to safeguard the reliability of the equipment.

These inspections should also be made to determine if components, wiring, and connections exhibit evidence of overheating.



WARNING

The periodical checks involve operations inside the UPS in presence of dangerous voltages. Only maintenance personnel trained by LEGRAND are authorized to intervene.

6.4 Ordinary maintenance

Contact a skilled technician if it is necessary to replace or add power modules, battery drawers or external battery cabinets.

6.5 Extraordinary maintenance

Contact the LEGRAND Technical Support Service if there are failures that require the access to internal parts of the UPS.

7. Warehousing



DANGER

All storage operations must be carried out only by a **SKILLED TECHNICIAN** (paragraph 2.2.1)



DANGER

A SKILLED TECHNICIAN must check that there is no voltage present before disconnecting the cables. All the battery isolator switches on the UPS and on the external battery cabinet must be open. The battery drawers of the UPS and of the external battery cabinet (if present) must be removed.

7.1 UPS

The UPS must be stored in an environment with a room temperature between -25°C (-13°F) and +55°C (+131°F) and humidity less than 95% (not condensing).

7.2 Batteries

It is possible to store batteries without recharging them in the following conditions:

- up to 6 months if the temperature is between +20°C (+68°F) and +30°C (+86°F);
- up to 3 months if the temperature is between +30°C (+86°F) and +40°C (+104°F);
- up to 2 months if the temperature is over +40°C (+104°F).



CAUTION

Batteries must never be stored if partially or totally discharged.

LEGRAND is not liable for any damage or bad functioning caused to the UPS by wrong warehousing of the batteries.

8. Dismantling



DANGER

Dismantling and disposal operations must be carried out only by a **SKILLED TECHNICIAN** (paragraph 2.2.1). The instructions in this chapter are to be considered indicative: in every country there are different regulations regarding the disposal of electronic or hazardous waste such as batteries. It is necessary to strictly adhere to the standards in force in the country where the equipment is used.
Do not throw any component of the equipment in the ordinary rubbish.

8.1 Battery disposal

Batteries must be disposed of in a site intended for the recovery of toxic waste. Disposal in the traditional rubbish is not allowed.

Apply to the competent agencies in your countries for the proper procedure.



Pb



WARNING

A battery may constitute a risk of electric shock and high short-circuit current. When working on batteries, the prescriptions indicated in chapter 2 must be adhered to.

8.2 UPS dismantling

The dismantling of the UPS must occur after the dismantling of the various parts it consists of.

For the dismantling operations, it is necessary to wear the Personal Protective Equipment mentioned in paragraph 2.3. Sub-divide the components separating the metal from the plastic, from the copper and so on according to the type of selective waste disposal in the country where the equipment is dismantled.

If the dismantled components must be stored before their disposal, be careful to keep them in a safe place protected from atmospheric agents to avoid soil and groundwater contamination.

8.3 Electronic component dismantling

For the disposal of electronic waste, it is necessary to refer to the relevant standards.



This symbol indicates that in order to prevent any negative effects on the environment and on people, this product should be disposed of separately from other household waste, by taking it to authorised collection centres, in accordance with the EU countries local waste disposal legislations. Disposing of the product without following local regulations may be punished by law. It is recommended to check that this equipment subject to WEEE legislations in the country where it is used.

9. Technical data

Main features

	3 111 34 Keor MOD RI 25	3 111 35 Keor MOD RI 50
Nominal Power (kVA)	25	50
Active Power (kW)	25	50
Number of power modules	1 (1 free slot for redundancy)	2 (1 free slot for redundancy)
Technology	online, double conversion VFI-SS-111 (EN IEC 62040-3)	
IN/OUT configuration	Three-phase / Three-phase	
Dual Input	Available	
UPS system	Modular, expandable and redundant	
Neutral system	Neutral passing straight from input to output (not isolated)	
Bypass	Automatic (static) Manual (for maintenance)	
Overvoltage category	OVC II	
AC power distribution system compatibility	TN, TT	

Input electrical characteristics

	3 111 34 Keor MOD RI 25	3 111 35 Keor MOD RI 50
Rated input current (A) (full load and 400V input voltage)	38	76
Maximum input current (A) (full load and 320V input voltage)	47	94
Input voltage (V)	400 + 15% - 20% (3P+N+PE)	
Input frequency (Hz)	50 / 60 ± 2% or 50 / 60 +14% - 6% (autosensing and/or selectable by the user)	
Input Power Factor	> 0.99	
Total harmonic distortion of the input current	THDi < 4% (at full load)	
I _{cp} Prospective short-circuit current (kA)	10	

Output electrical characteristics (normal mode)

	3 111 34 Keor MOD RI 25	3 111 35 Keor MOD RI 50
Rated output current (A) (full load and 400V input voltage)	36	72
Maximum output current (A) (full load and 380V input voltage)	38	76
Output voltage (V)	380/400/415 ± 1% (3P+N+PE)	
Output frequency (Hz)	50 / 60 (selectable by the user)	
Range of the output frequency	If synchronized with the bypass frequency: adjustable range from +14% to -6% If not synchronized (free run): ± 0.1 Hz	
Crest factor admitted on the output current	3:1	
Total harmonic distortion of the output voltage	THDv < 3.3% (measured according to EN IEC 62040-3)	
Efficiency in Normal Mode	up to 96.5%	
Efficiency in Eco Mode	up to 98.8%	
Overload capacity	125% for 10 minutes without automatic bypass intervention 150% for 60 seconds without automatic bypass intervention	

Output electrical characteristics (battery mode)

	3 111 34 Keor MOD RI 25	3 111 35 Keor MOD RI 50
Output voltage (V)	380/400/415 ± 1%	
Output frequency (Hz)	50 / 60 Hz ± 1%	
Total harmonic distortion of the output voltage	THDv < 3.2% (measured according to IEC 62040-3)	
Overload capacity	115% for 10 minutes	
Shortcircuit	Icc = 3 In for 50 ms	

9. Technical data

Batteries and battery charger characteristics

	3 111 34 Keor MOD RI 25	3 111 35 Keor MOD RI 50
Nominal battery voltage (V)	± 264 (44 blocks)	
Battery voltage range (V)	± 264 to ± 312 (44-52 blocks)	
Battery wiring	Internal batteries string made up of 2 drawers (one drawer has 22 batteries: 4 blocks of 4 batteries and 2 blocks of 3 batteries) External batteries	
Battery type	VRLA 12 Vdc - 9 Ah 12 Vdc - 11 Ah	
Type of battery charger	High performance PWM, one for each power module Smart charge technology (3-stage advanced cycle)	
Maximum recharge current (A)	5 (for each power module)	

Features

	3 111 34 Keor MOD RI 25	3 111 35 Keor MOD RI 50
Display	10-inch colour touchscreen	
Communication ports	2 x RS485 ports (one for external accessories) 10 input floating contacts 8 output floating contacts 1 interface slot USB host port	
Protections	Backfeed protections (NC/NO auxiliary contact) Emergency Power Off (EPO) Electronic against overloads, short-circuit and excessive battery discharge Block of functions due to the end of autonomy In-rush limiter on start up Internal battery circuit fuses (for internal battery drawers)	
Remote management	available	

Mechanical characteristics

	3 111 34 Keor MOD RI 25	3 111 35 Keor MOD RI 50
Net weight (kg)	67	72
Dimensions H x W x D (mm)	663 (15U) x 447 x 874	930 (21U) x 447 x 874
Installable power modules PM25 3 106 75	up to 2 (1 only for redundancy)	up to 3 (1 only for redundancy)
Installable battery drawers	2	4
PM25 net weight (kg)	22.5	
Weight of one battery drawer (kg)	63 (9Ah batteries) 71 (11Ah batteries)	

Environmental conditions

	3 111 34 Keor MOD RI 25	3 111 35 Keor MOD RI 50
Operating temperature (°C)	0 ÷ +40	
Relative humidity during operation	0% ÷ 95% non-condensing	
Storage temperature (°C)	-25 ÷ +55 (excluding batteries)	
Noise level at 1 metre (dBA)	50 ÷ 65 (one PM 25)	
Pollution degree	PD2	
Climatic class (60721-3-3)	3K22	
Special climatic class (60721-3-3)	3Z2	
Biological class (60721-3-3)	3B2	
Mechanical active substances class (60721-3-3)	3S5	
Mechanical class (60721-3-3)	3M11	
Ingress Protection Marking	IP 20	
Operating height	up to 1000 metres above sea level without derating	
Heat dissipation with full load (BTU/h)	3560	7120

Reference directives and standards

	3 111 34 Keor MOD RI 25	3 111 35 Keor MOD RI 50
Marks	CE, CMIM, UKCA	
Safety	2014/35/EU Directive EN IEC 62040-1	
EMC	2014/30/EU Directive EN IEC 62040-2	
Performance and test requirements	EN IEC 62040-3	

LEGRAND
Pro and Consumer Service
BP 30076 - 87002
LIMOGES CEDEX FRANCE
www.legrand.com

┌ Installer stamp ───────────┐

└───────────────────────────┘