

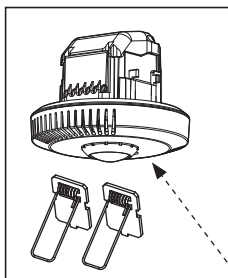

- Documentation technique disponible dans votre langue => Scanner le QR code
- Technical documentation available in your language => Scan the QR code
- Documentación técnica disponible en su idioma => Escanear el código QR
- Documentazione tecnica disponibile nella vostra lingua => Scansionare il codice QR
- Technische documentatie beschikbaar in jouw taal. => Scan de QR-code



Legrand Close Up



	110 - 230 V~	
	50 / 60 Hz	
	2 x 1.5 mm ² of 1 x 2.5 mm ²	
	+5°C / +30°C	
		PIR
	300 lux	
	15 mn	
	Doorgangsmodus	
	Hoogte 2.5 m 1.7 m min Ø 12 m (2.5 m)	
Bluetooth®	5.0 compatibel 4.2	Outreach : 10 m
Radio	2.4 - 2.483 GHz	
	Gegarandeerd -V- 16 V -A- 100 mA	Maximum -V- 16 V -A- 130 mA
Verbruik in de wachtstand	Belasting OFF → 1.15 W	Belasting ON → 2.27 W
Lichtsensör	5 → 1275 lux	
Vochtigheidssensör	20 % → 80 %	
Geluidssensör	38 → 120 dB SPL	
Temperatuursensör	0°C / +50°C	
VOST-sensör	0 → 10 000 ppb	
Luchtkwaliteitsniveau	1.0 → 5.0	
Geschat CO2-gehalte	400 → 5000 ppm	

- F (frequentie): 2,4 tot 2,483 GHz
- P (vermogen): <100 mW

LEGRAND verklaart dat de radioapparatuur van het type ref. **0 485 73** aan richtlijn **2014/53/EU** voldoet. De volledige tekst van de EU-verklaring van overeenstemming kan worden aangevraagd op het volgende adres: www.legrand.com/ecatalogue

LIGHT UP DALI 3-zonedetectoren sturen 3 verlichtingszones aan:

- dimmen aan de raanzijde
- dimmen aan de gangkant
- AAN/UIT aan de paneelzijde

De draadloze, batterijloze drukknop regelt alleen de AAN/UIT-uitgang aan de paneelzijde.

De bedrade knop dimt de andere twee zones.

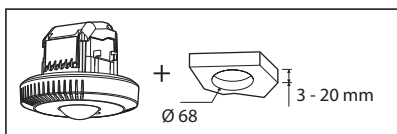

De montage en de bedrading moeten zonder spanning worden uitgevoerd.

Neem de veiligheidsinstructies nauwgezet in acht.

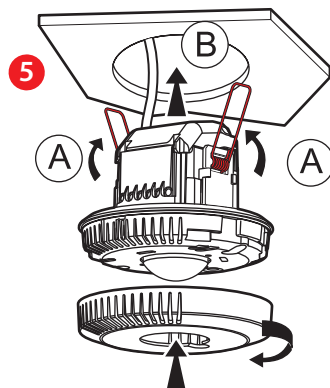
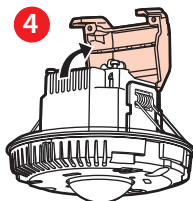
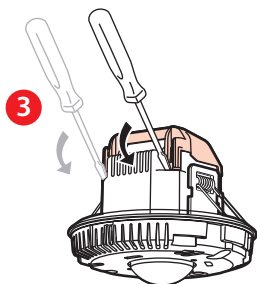
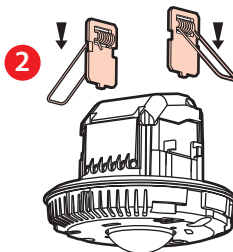
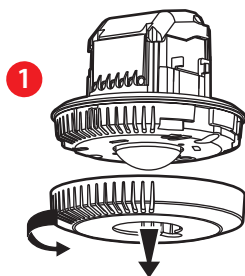

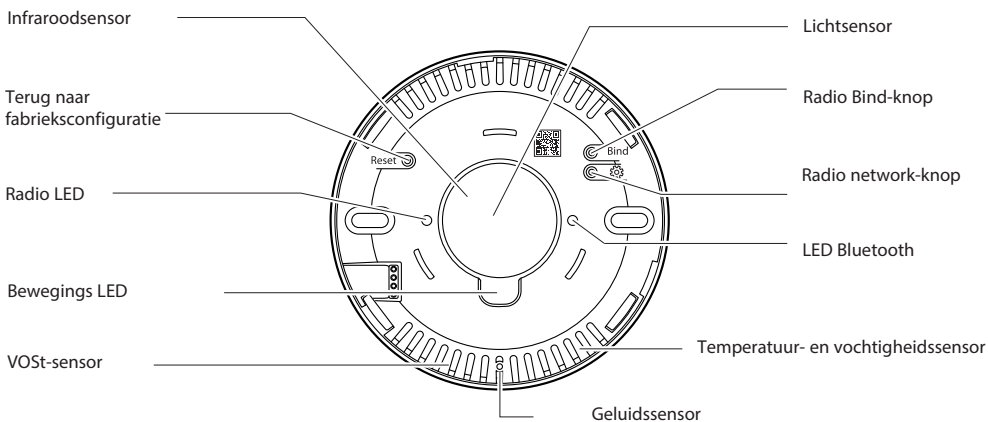

• **Bedrading**

• **Zelfstandig**

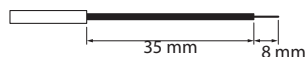

- (*) Dit product kan worden aangestuurd met:
- Een draadloze bediening zonder batterijen (ON/OFF zonder dimmen)
 - Of
 - Een bedrade bediening (ON/OFF en dimmen)
- En het kan een geconnecteerde contactdoos (draadloos) aansturen.

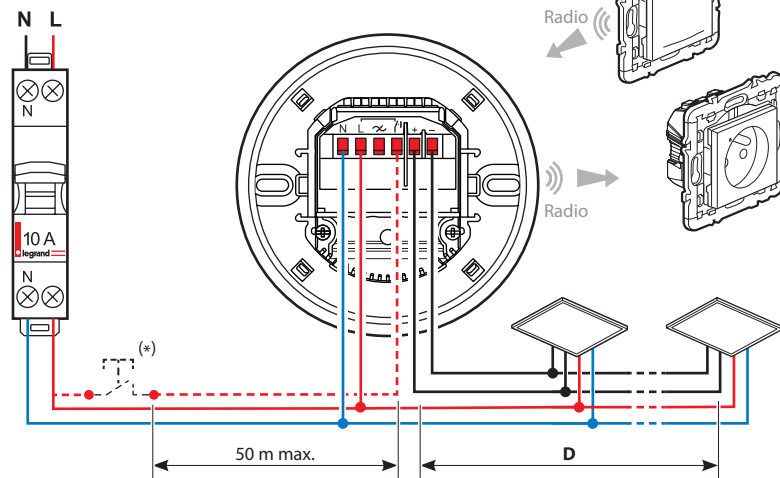

De maximumafstand van de bediening tot de hulpingang bedraagt 50 m.

Om aan dit product een bedieningspunt en/of een contactdoos te koppelen, raadpleegt u de beschrijving van de procedures in de **Technische gids voor LIGHT UP.**

• **Bedrading**

• **Type belasting 'DIMBAAR'**

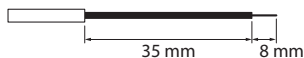

Het relais is bedoemd om het voorschakelapparaat van stroom te voorzien om het energieverbruik te verlagen, en de uitschakeling van de voorschakelapparaten wordt met 5 minuten vertraagd.

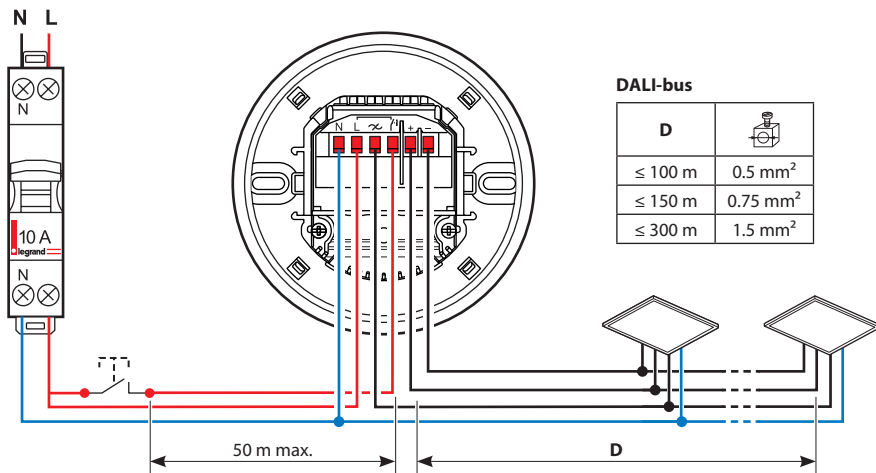

De maximumafstand van de bediening tot de hulpingang bedraagt 50 m.

• **Type belasting 'NIET-DIMBAAR'**

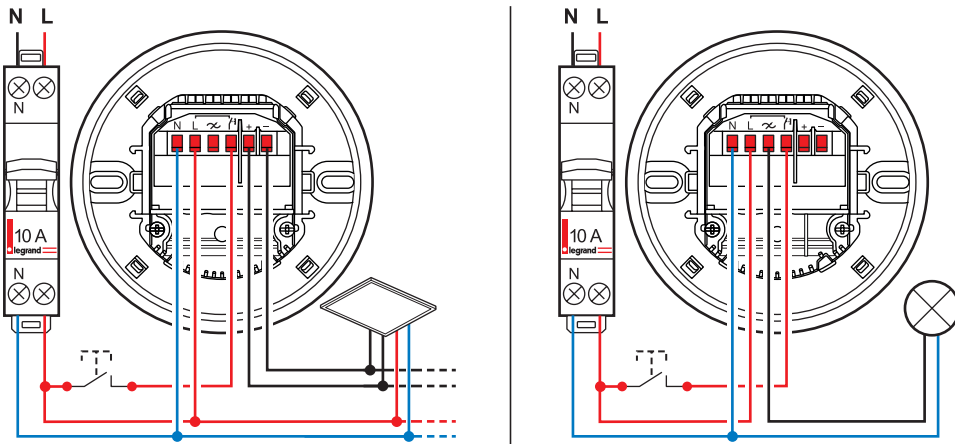

Detector 0 485 73 is geconfigureerd om Dimbare DALI-voorschakelapparaten aan te sturen; het is mogelijk om er DALI-actuatoren (ON/OFF) aan te koppelen. Gebruik hiervoor de app 'Legrand Close Up' op uw smartphone om het gebruikte type belasting te wijzigen, in dit geval 'Niet-dimbaar'.

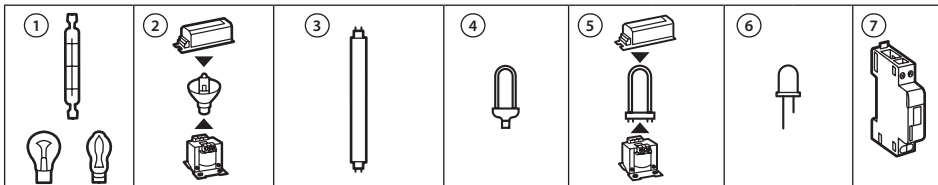

230 V~	1500 W	6.5 A	1000 VA	4.3 A	10x(2x36 W)	4.3 A	500 VA	2.1 A	1000 VA	4.3 A	350 VA	2.1 A	I max. ≤ 2A
110 V~	750 W		500 VA		5x(2x36 W)		250 VA		500 VA		175 VA		

- 1 - Gloei- en halogeenlamp
- 2 - Halogeenlamp met aparte gewikkelde of elektronische transformator
- 3 - Fluorescentiebuis
- 4 - Compacte fluorescentielamp met geïntegreerd voorschakelapparaat
- 5 - Compacte fluorescentielamp met aparte gewikkelde of elektronische transformator
- 6 - Ledlamp
- 7 - Contactor

• **Master/Slave**

Het product is standaard geconfigureerd als **Master**.

Om het als **Slave** te configureren, volg de beschrijving in de **Technische Gids van LIGHT UP**.

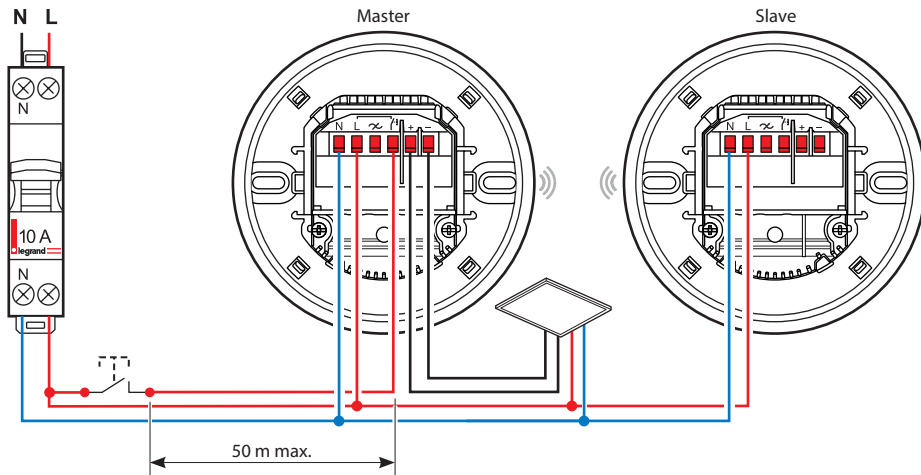

Als slave kan het product het detectiegebied vergroten. Er zal geen belasting aan worden gekoppeld.

Bij gebruik als **'Master/Slave'** mag de drukknop alleen op de 'Master'-detector worden aangesloten.



Auto ON/OFF



Handmatig ON / Auto OFF

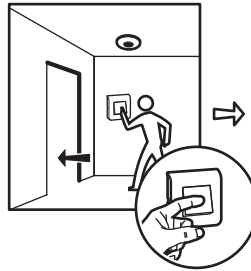
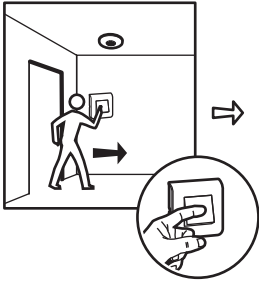

Axiale benadering

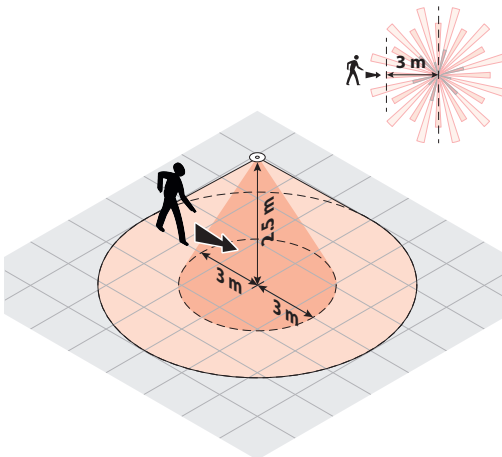

Transversale benadering

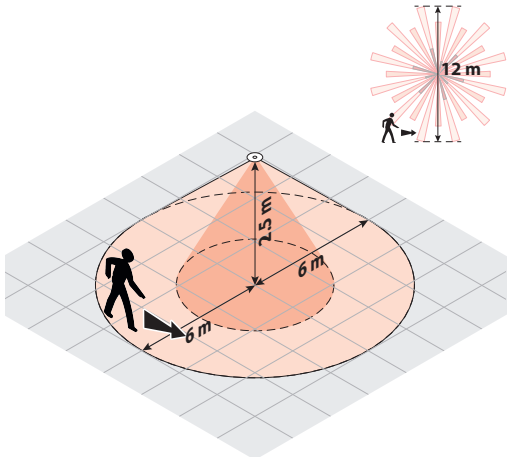

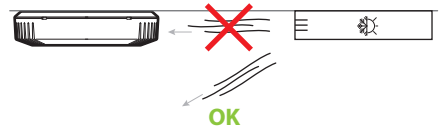
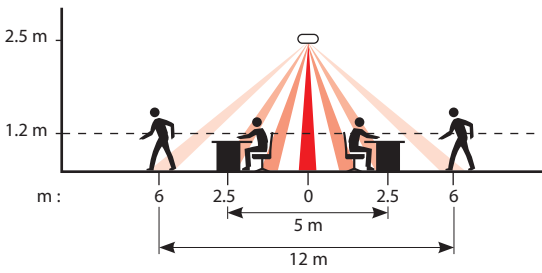

Vermijd een directe lichtstroom over de ventilatieopeningen van het product. Plaats de detector op een afstand van meer dan 1,5 m van een glazen wand om reflectie van het infrarood te voorkomen.

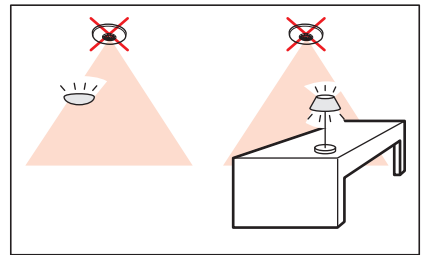
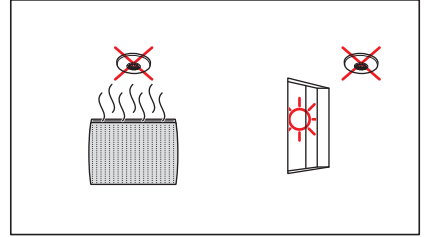
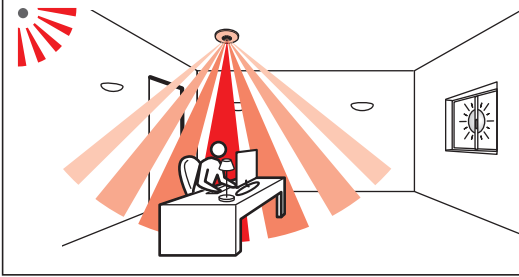

Accessoire om het detectiegebied te beperken

