

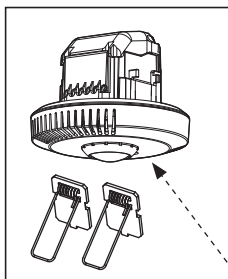

- Documentation technique disponible dans votre langue => Scanner le QR code
- Technical documentation available in your language => Scan the QR code
- Documentación técnica disponible en su idioma => Escanear el código QR
- Documentazione tecnica disponibile nella vostra lingua => Scansionare il codice QR
- Technische documentatie beschikbaar in jouw taal. => Scan de QR-code



Legrand Close Up



| | | |
|---|--|--|
| | 110 - 230 V~ | |
| | 50 / 60 Hz | |
| | 2 x 1.5 mm ² ou/or 1 x 2.5 mm ² | |
| | +5°C / +30°C | |
| | PIR | |
| | 300 lux | |
| | 15 mn | |
| | <ul style="list-style-type: none"> • Mode Passage • Walkthrough mode | |
| Hauteur/Height 2.5 m ↑ 1.7 m min ↓ | Ø 12 m (2.5 m) | |
| Bluetooth [®] | 5.0 compatible 4.2 | <ul style="list-style-type: none"> • Portée : 10 m • Reach: 10 m |
| Radio | 2.4 - 2.483 GHz | |
| | Garantie/ Guaranteed -V- 15 V -A- 100 mA | Maximum -V- 15 V -A- 130 mA |
| <ul style="list-style-type: none"> • Consommation en veille : • Standby consumption: | Charge/Load OFF → 1.15 W | Charge/Load ON → 2.27 W |
| <ul style="list-style-type: none"> • Capteur de luminosité • Daylight sensor | 5 → 1275 lux | |
| <ul style="list-style-type: none"> • Capteur d'humidité • Humidity sensor | 20 % → 80 % | |
| <ul style="list-style-type: none"> • Capteur sonore • Sound sensor | 38 → 120 dB SPL | |
| <ul style="list-style-type: none"> • Capteur de température • Temperature sensor | 0°C / +50°C | |
| <ul style="list-style-type: none"> • Capteur COVt • VOCt sensor | 0 → 10 000 ppb | |
| <ul style="list-style-type: none"> • Niveau Qualité de l'air • IAQ level | 1.0 → 5.0 | |
| <ul style="list-style-type: none"> • Niveau de CO₂ estimé • Estimated CO₂ level | 400 → 5000 ppm | |

F (Fréquence) : 2,4 à 2,483 GHz
 P (Puissance) : <100 mW

F (Frequency) : 2.4 to 2.483 GHz
 P (Power) : <100 mW

• Le soussigné, **LEGRAND**, déclare que l'équipement radioélectrique du type réf. **0 485 71** est conforme à la directive **2014/53/UE**. Le texte complet de la déclaration UE de conformité est disponible à l'adresse suivante : www.legrandoc.com

• **LEGRAND** declares that radio equipment of the type Cat. no. **0 485 71** complies with Directive **2014/53/EU**. The full text of the EU declaration of conformity can be found at: www.legrandoc.com

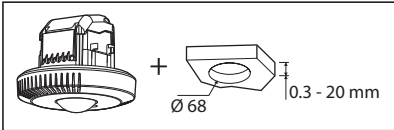
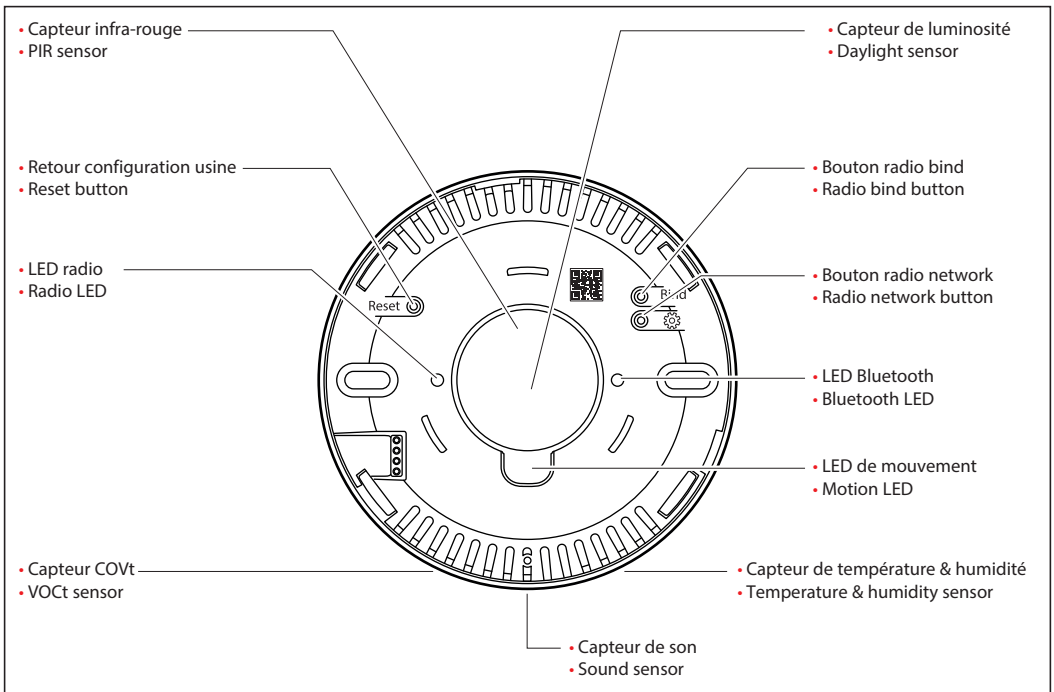

• Le montage et le câblage doivent être réalisés hors tension.
 • **Merci de suivre scrupuleusement les Consignes de Sécurité.**
 • Installation and wiring must be carried out with the power off.
 • **Please follow the Safety Instructions carefully.**

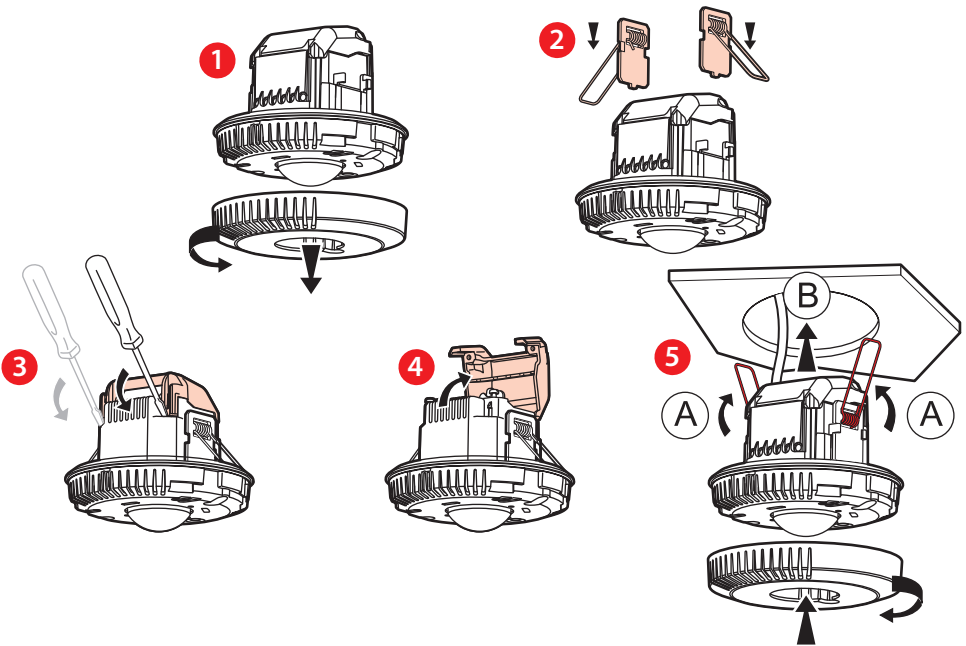

- **Câblage**
- **Autonome**

- **Wiring**
- **Stand-alone**

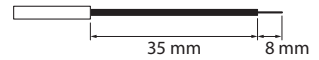

- (*) Ce produit peut être commandé par :
 - Une commande sans fils sans pile (ON/OFF sans variation)
 - Ou
 - Une commande filaire (ON/OFF et variation)
 Et il peut piloter (sans fils) une prise connectée.

- (*) This product can be controlled by:
 - A wireless batteryless control (ON/OFF without dimming)
 - Or
 - A wired control (ON/OFF and dimming)
 And it can control (in wireless mode) a connected outlet.

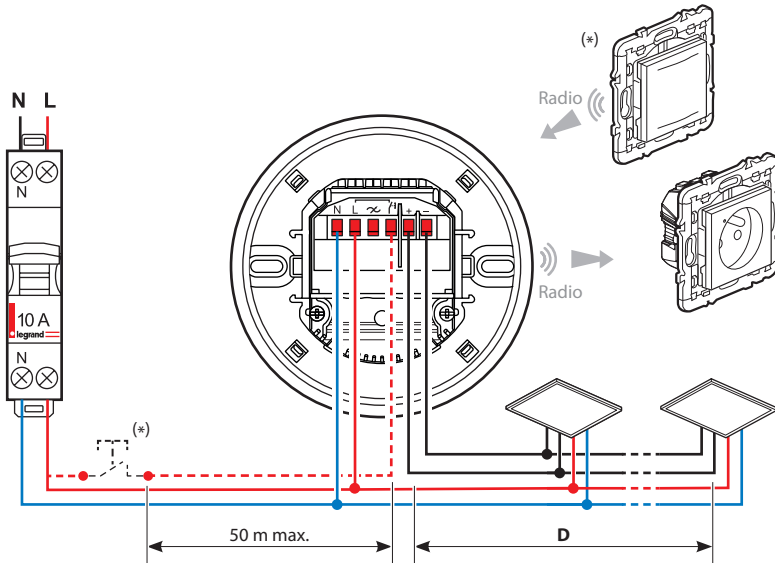

Bus DALI / DALI Bus

| D |  |
|---------|---|
| ≤ 100 m | 0.5 mm ² |
| ≤ 150 m | 0.75 mm ² |
| ≤ 300 m | 1.5 mm ² |

- La distance maximum de la commande à l'entrée auxiliaire est de 50 m.

- The maximum distance from the control to the auxiliary input is 50 m.

- Pour associer à ce produit, un point de commande et/ou une prise, veuillez suivre la description des procédures du **Guide technique Light Up**.

- To associate this product with a control point and/or outlet, please follow the procedures described in the **Light Up Technical Guide**.

- Câblage
- Type de charge "VARIATION"

- Wiring
- Type of load "DIMMING"



Le relais est dédié à l'alimentation du ballast pour réduire la consommation d'énergie, la mise hors tension des ballasts est retardée de 5 minutes.

The relay is dedicated to powering the ballast to reduce energy consumption, and there is a 5 minute delay before the ballasts switch off.

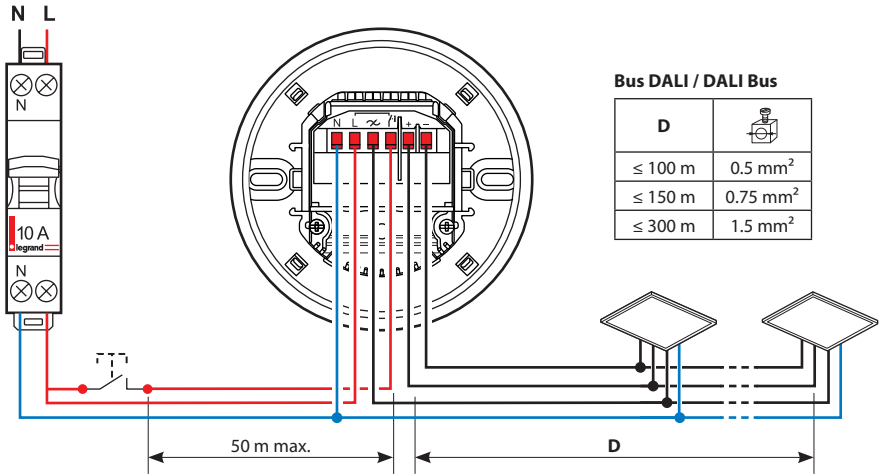

La distance maximum de la commande avec l'entrée auxiliaire est de 50 m

The maximum distance from the control to the auxiliary input is 50 m

- Type de charge "NON DIMMING"

- Type of load "NO DIMMING"

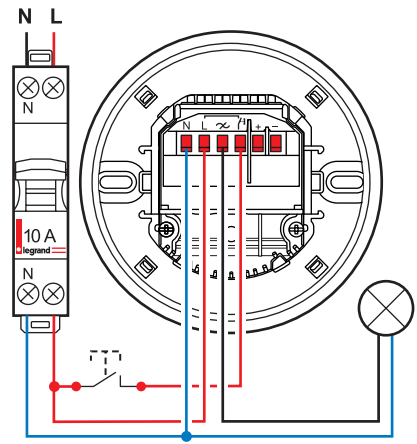
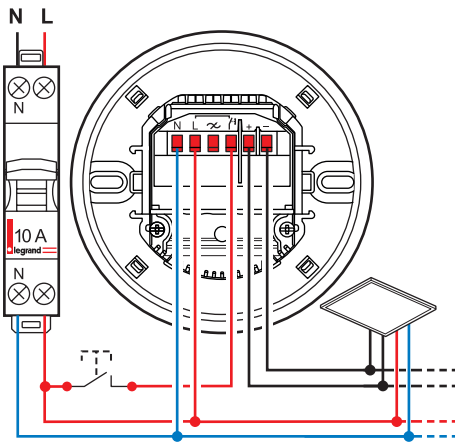

Le détecteur 0 485 71 est configuré pour piloter des ballasts DALI Dimmables ; il est possible de lui associer des actionneurs DALI (ON/OFF) pour cela il faut à partir de votre smartphone en utilisant l'application "Legrand Close Up" modifier le type de charge utilisée, dans ce cas "Non Dimming"



The 0 485 71 detector is configured to control dimmable DALI ballasts; it is possible to link DALI actuators (ON/OFF) to it. To do this, use the "Legrand Close Up" application on your smartphone to change the type of load used, in this case "No Dimming".

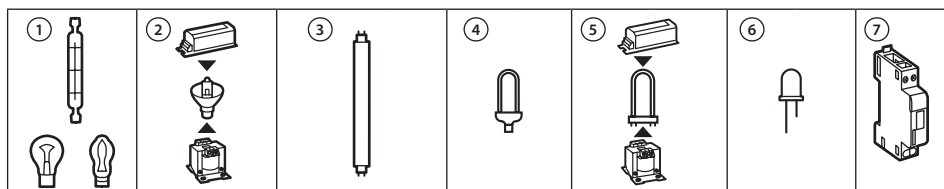

| | | | | | | | | | | | | | |
|--------|--------|-------|---------|-------|-------------|-------|--------|-------|---------|-------|--------|-------|-------------|
| 230 V~ | 1500 W | 6.5 A | 1000 VA | 4.3 A | 10x(2x36 W) | 4.3 A | 500 VA | 2.1 A | 1000 VA | 4.3 A | 350 VA | 2.1 A | I max. ≤ 2A |
| 110 V~ | 750 W | | 500 VA | | 5x(2x36 W) | | 250 VA | | 500 VA | | 175 VA | | |

- 1 - Lampe à incandescence et halogène
 - 2 - Lampe halogène à transformateur ferromagnétique ou électronique séparé
 - 3 - Tube fluoescents
 - 4 - Lampe fluocompacte à ballast intégré
 - 5 - Lampe fluocompacte à transformateur ferromagnétique ou électronique séparé
 - 6 - Lampe à LEDs
 - 7 - Contacteur
- 1 - Incandescent and halogen lamps
 - 2 - Halogen lamp with separate ferromagnetic or electronic transformer
 - 3 - Fluorescent tubes
 - 4 - Compact fluorescent lamp with integrated ballast
 - 5 - Compact fluorescent lamps with transformer ferromagnetic or separate electronic
 - 6 - LED lamp
 - 7 - Contactor

• **Maitre/Esclave**

- Le produit est configuré par défaut en **Maitre**. Pour le passer en **Esclave**, suivre la description dans le **Guide technique Light Up**.

• **Master/Slave**

- The product is configured as **Master** by default. To change it to **Slave**, follow the description in the **Light Up Technical Guide**.

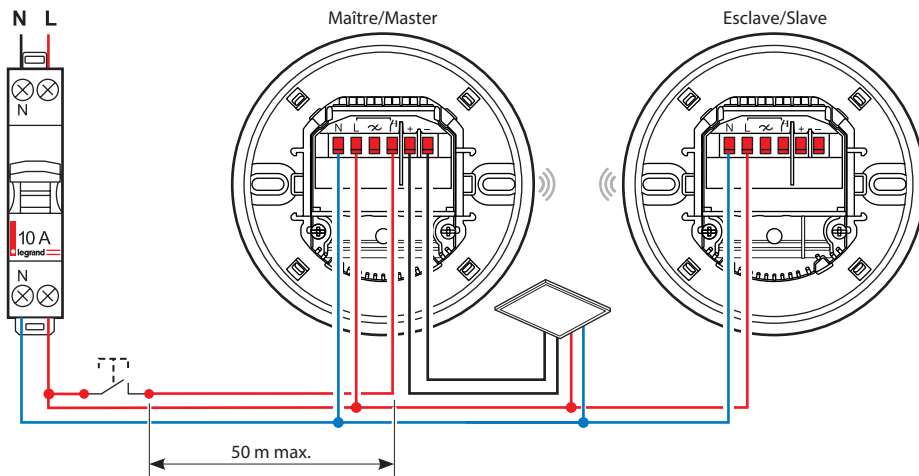

- L'esclave permet d'étendre la zone de détection. Aucune charge ne lui sera associée.
- Dans le cas d'une utilisation en "**Maitre/Esclave**", le poussoir devra être uniquement connecté au détecteur "**Maitre**".
- The slave extends the detection area. No load will be associated with it.
- If used in "**Master/Slave**" mode, the push-button should only be connected to the "**Master**" detector.



Auto ON/OFF



Manual ON / Auto OFF

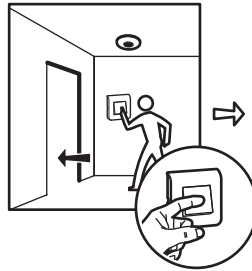
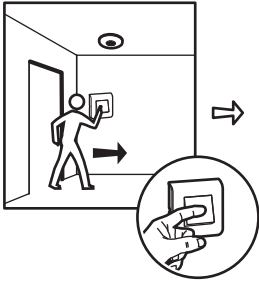

- Approche axiale
- Walk towards

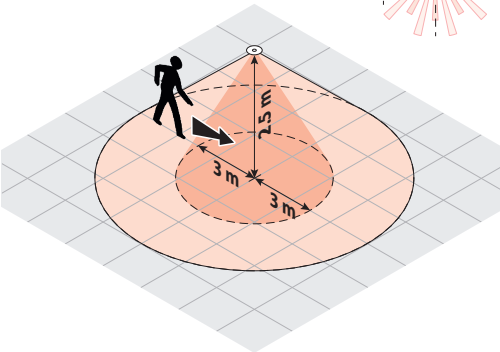
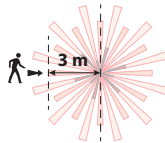

- Approche transversale
- Walk across

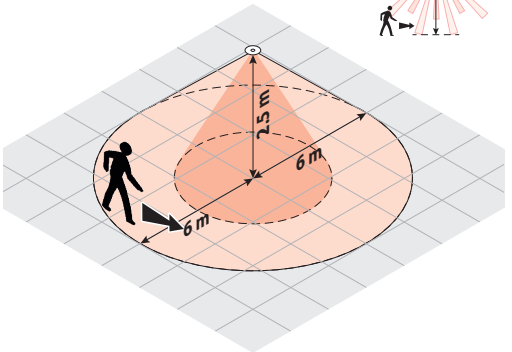
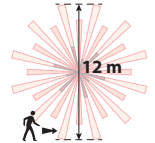

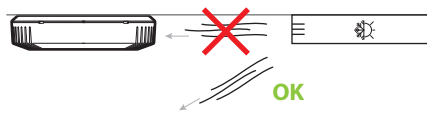
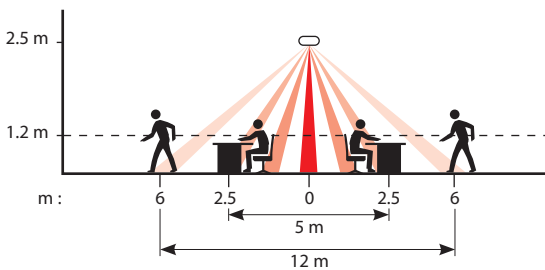

- Éviter les flux d'air direct sur les aérations du produits. Placer le détecteur à une distance supérieure à 1,5m d'une paroi vitrée afin d'éviter la réflexion de l'infrarouge.
- Avoid direct airflow over product vents. Place the detector at a distance of over 1.5m from a glass surface to avoid infra-red reflection.

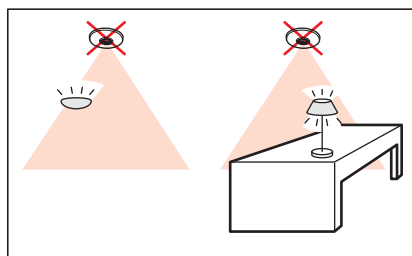
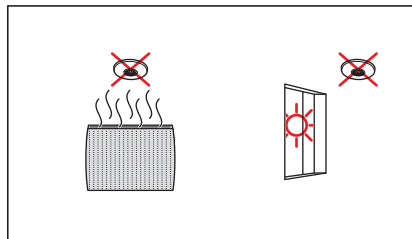
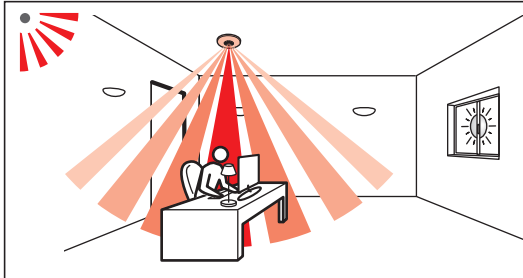

• Accessoires pour limiter la zone de détection

• Accessories to limit the detection area

