

 35° C 0° C 100-240 V 50/60 Hz	 2 x 2,5 mm ²
--	-----------------------------

Technologie	Radiofréquence 2,4GHz (16 canaux) - Débit : 250 kbits/s Réseau sans fil maillé, auto-adaptatif et sécurisé (AES128), selon la norme IEEE 802.15.4 (LR-WPAN); Puissance RF max : < 20 dBm/100 mW
Performance	Portée : 150 m en champ libre point à point

Technology	Radio frequency 2.4GHz (16 channels) - Data rate : 250kbits/s Meshed wireless network self-adapting and secure (AES128), in accordance with IEEE 802.15.4 standard (LR-WPAN); Max. RF power: < 20 dBm/100 mW
Performance	Range: 150 m free field point to point

Tecnología	Radiofrecuencia 2,4 GHz (16 canales) - Velocidad: 250 Kbits/s Red inalámbrica mallada, auto-adaptativa y segura (AES 128), según la norma IEEE 802.15.4 (LR-WPAN); Potencia RF máx.: < 20 dBm/100 mW
Rendimiento	Alcance: 150 m en campo abierto entre dos puntos

Tecnologia	Frequenza radio 2,4 GHz (16 canali) - Velocità dati: 250 kbit/s Rete wireless meshed autoadattante e sicura (AES128), secondo lo standard IEEE 802.15.4 (LR-WPAN); Potenza RF max: < 20 dBm/100 mW
Performance	Portata: 150 m in campo libero punto a punto

	①	②	③	④	⑤	⑥	⑦	⑧
240 V~ - Max.	2 x 1000 W	2 x 1000 W	2 x 1000 VA	2 x 1000 VA	2 x 500 VA	2 x 500 VA	2 x 30 W	2 x 100 VA
100 V~ - Max.	2 x 500 W	2 x 500 W	2 x 500 VA	2 x 500 VA	2 x 250 VA	2 x 250 VA	2 x 15 W	2 x 50 VA

- ① • Lampe incandescente
• Incandescent lamp
• Lámpara incandescente
• Lampada a incandescenza

- ② • Lampe halogène
• Halogen lamp
• Lámpara halógena
• Lampada alogena

- ③ • Transformateur électronique
• Electronic transformer
• Transformador electrónico
• Trasformatore elettronico

- ④ • Transformateur ferromagnétique
• Ferromagnetic transformer
• Transformador ferromagnético
• Trasformatore ferromagnetico

- ⑤ • Tube fluorescent
• Fluorescent tube
• Tubo fluorescente
• Tubo fluorescente

- ⑥ • Fluocompact
• Compact fluorescent
• Fluocompacto
• Fluorescente compatta

- ⑦ • Lampe à LED
• Led lamp
• Lámpara Led
• Lampada a led

- ⑧ • Moteur de ventilateur
• Fan motor
• Motor de ventilador
• Motore del ventilatore

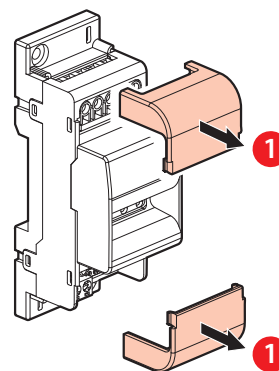
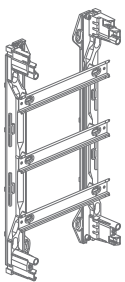

Ou/Or

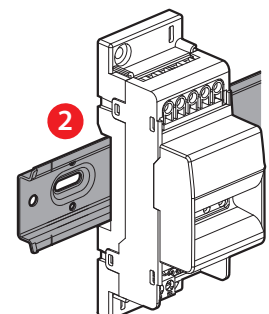
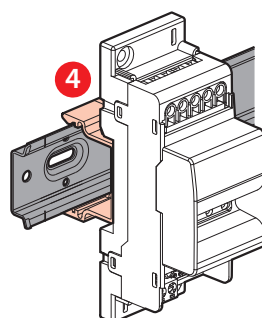
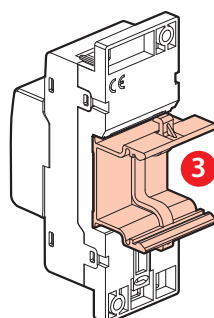
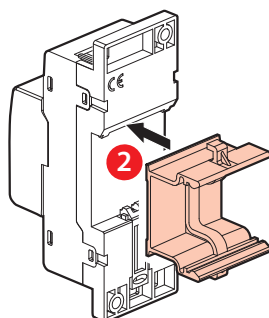

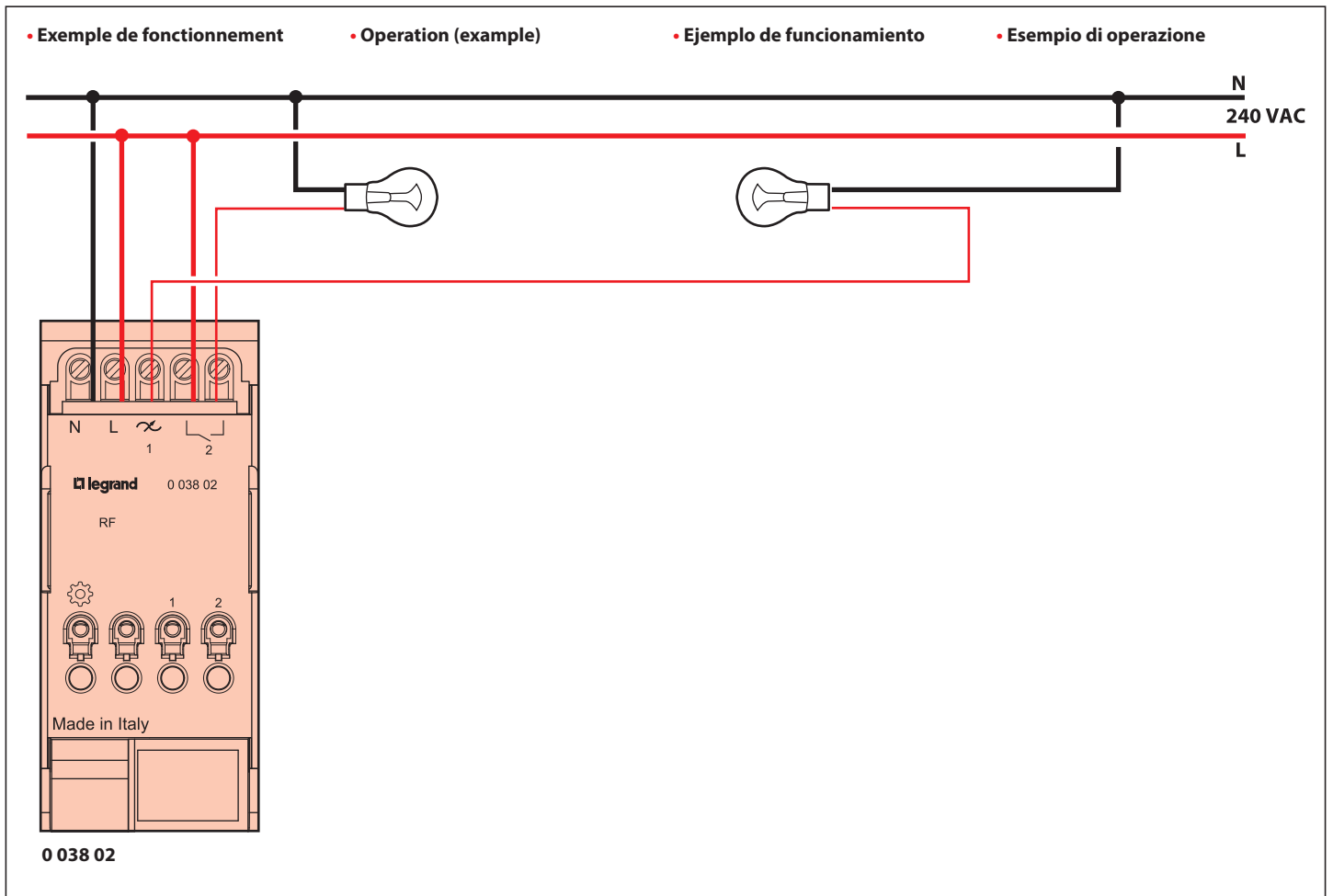
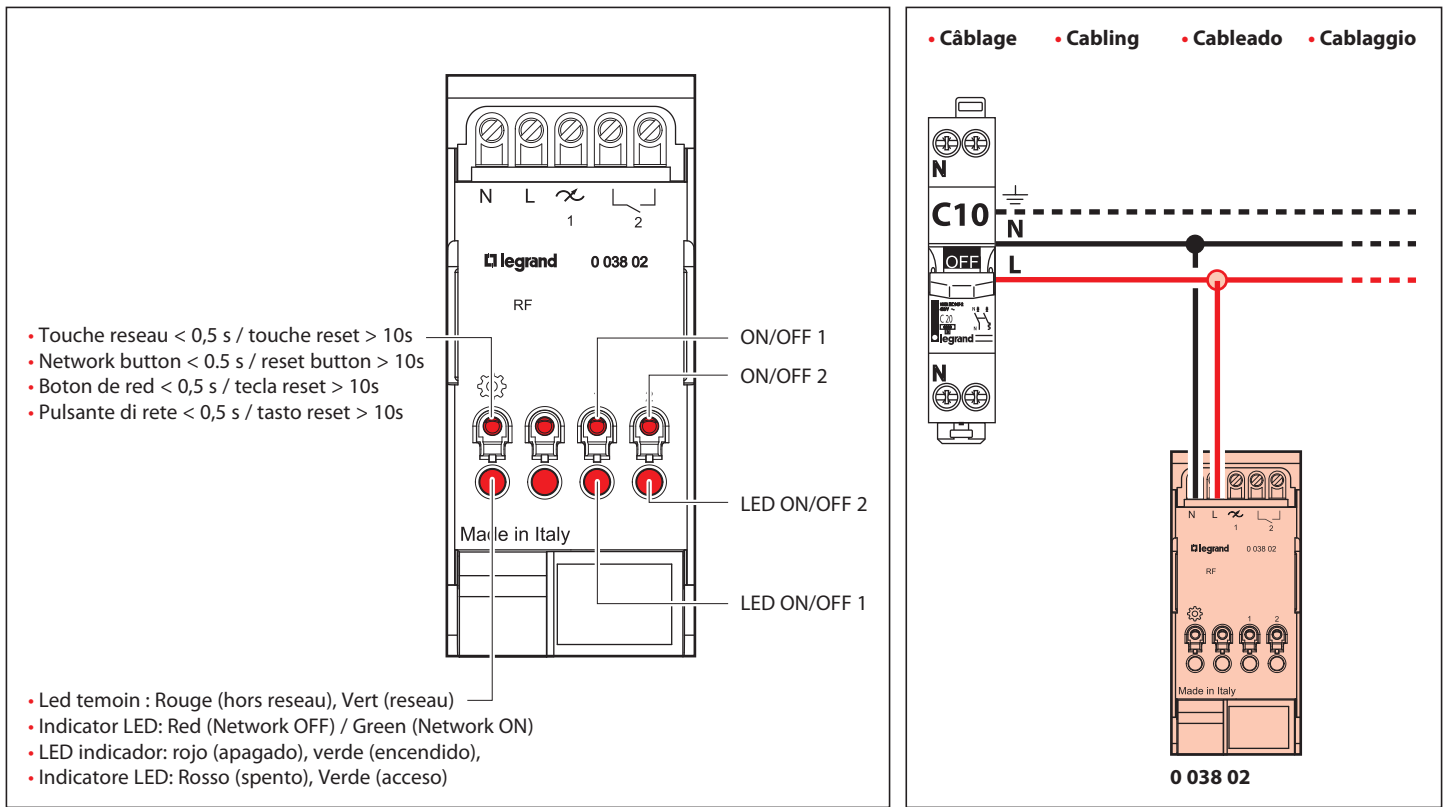

• Le soussigné, LEGRAND, déclare que l'équipement radioélectrique du type (0 038 02) est conforme à la directive 2014/53/UE. Le texte complet de la déclaration UE de conformité est disponible à l'adresse suivante : www.legrandoc.com

• The undersigned, LEGRAND, declares that radio equipment of the type (0 038 02) complies with Directive 2014/53/EU. The full text of the EU declaration of conformity can be found at: www.legrandoc.com

• El abajo rmante, LEGRAND, declara que el equipo radioeléctrico de tipo (0 038 02) cumple con la directiva 2014/53/UE. El informe completo de la declaración UE de conformidad se encuentra disponible en: www.legrandoc.com

• Il sottoscritto, LEGRAND, dichiara che l'apparecchiatura radio di tipo (0 038 02) è conforme alla direttiva 2014/53/UE. Il testo completo della dichiarazione di conformità UE è disponibile su www.legrandoc.com