

Requires you to buy and install the «... with Netatmo» connected starter pack

Gateway power outlet control and Home/away wireless Master control

Control Module

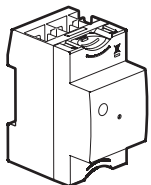

OR

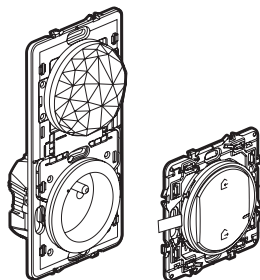

Pack Contents

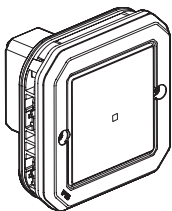

Connected switch with neutral (with dimmer option)

⚠ Safety instructions

This product should be installed in compliance with installation rules, preferably by a qualified electrician. Incorrect installation and/or incorrect use can lead to risk of electric shock or fire. Before carrying out the installation, read the instructions and take account of the product's specific mounting location. Do not open up, dismantle, alter or modify the device except where specifically required to do so by the instructions. All **Legrand** products must be opened and repaired exclusively by personnel trained and approved by **Legrand**. Any unauthorised opening or repair completely cancels all liabilities and the rights to replacement and guarantees. Use only **Legrand** brand accessories.

LE12816AA

Characteristics

In default operating mode (on/off), this switch works with the following bulbs :



Do not use a smart bulb with the connected switch with neutral (with dimmer option).

 +45°C +5°C 110-240 VAC 50/60 Hz	 2 x 2,5 mm ²		LED 		
240 VAC	Maxi.	150 W	^(*) 150 VA	150 VA	150 VA
110 VAC	Maxi.	75 W	^(*) 75 VA	75 VA	75 VA

^(*) or 15 bulbs max. For comfortable lighting, we recommend using bulbs of the same type and make.

Product NOT COMPATIBLE with ferromagnetic transformer
 Risk of product breaking



In dimmer option operating mode (which can be activated via the App), this switch functions only with dimmable bulbs (identifiable by the logo on packaging).



Tip if replacing a twoway switch :

old flush-mounted switch replaced by the wireless switch.

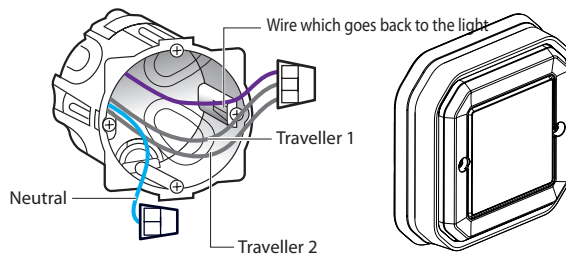

Use a connector to connect all 3 wires together (travellers 1 and 2 and lamp return wire).
 Use an other connector for neutral wire.

Before starting : wiring precautions

If you plan to install two-way light switches, read the following precautions :
To control a light with **two or more switches**, only use the following products :

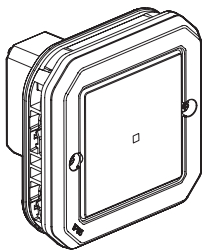

Connected switch with neutral (with dimmer option)

AND

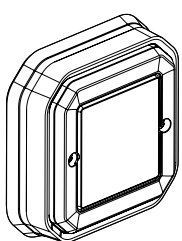

X1 or many

AND/OR

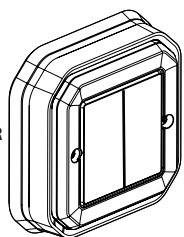

X1 or many

AND/OR

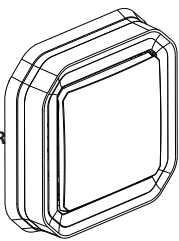

X1 or many

Wireless switches for all control points (not included in this pack) up to 5 push buttons (not included in this pack)



Do not use: two connected switches (with dimmer option) to control the same lighting point.

① Necessary safety precautions

1



OFF

Switch off the power at the main circuit breaker

2



Make sure that the power is off before continuing with the installation.

② Make sure that the power is off before continuing with the installation.

1

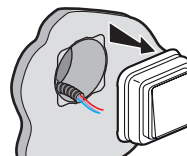

Remove the old switch

② Wire the connected switch

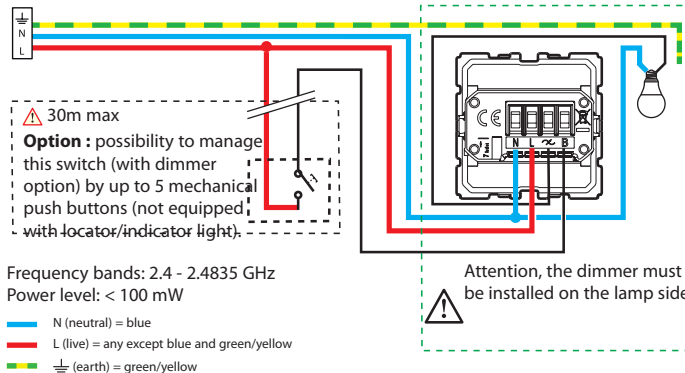

Frequency bands: 2.4 - 2.4835 GHz
Power level: < 100 mW

- N (neutral) = blue
- L (live) = any except blue and green/yellow
- ⊕ (earth) = green/yellow



The connected light switch (with dimmer option) works with standard bulbs or dimmable bulbs including LEDs. Using dimmable LEDs is mandatory if dimmer mode is activated.



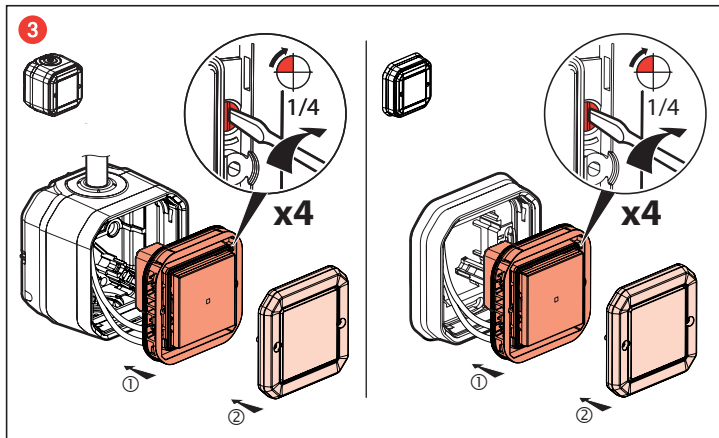

③ To add a connected product to your connected installation, you should follow the instructions:

- in the **Legrand Home + Control** application (Settings/Add a new product section)
- or consult the user manual on **legrand.com**



www.legrand.com

LEGRAND - Pro and Consumer Service - BP 30076
87002 LIMOGES CEDEX FRANCE • www.legrand.com

SIMPLIFIED **EU** DECLARATION OF CONFORMITY

The undersigned, **Legrand**

declares that the radio-electric equipment referred to in these instructions complies with directive 2014/53/EU. The full text of the EU declaration of conformity is available on the following website :

www.legrandoc.com