

# Step light motion detector

2 810 96xx

xx:MW MB MG DS DB CH BA BB BC

2 810 96xx yy

yy:MY SG



## ⚠ Safety instructions

GB CA IN IE US SG

This product should be installed in compliance with installation rules, preferably by a qualified electrician. Incorrect installation and/or incorrect use can lead to risk of electric shock or fire.

Before carrying out the installation, read the instructions and take account of the product's specific mounting location.

Do not open up, dismantle, alter or modify the device except where specifically required to do so by the instructions.

All Legrand products must be opened and repaired exclusively by personnel trained and approved by Legrand. Any unauthorised opening or repair completely cancels all liabilities and the rights to replacement and guarantees.

Use only Legrand brand accessories.

## Presentation

					 100-240V~ 50/60Hz
	-20°C...+70°C	-5°C ...+35°C	≥40mm	8 mm 1...4mm <sup>2</sup>	Pmax. = 1.0 W

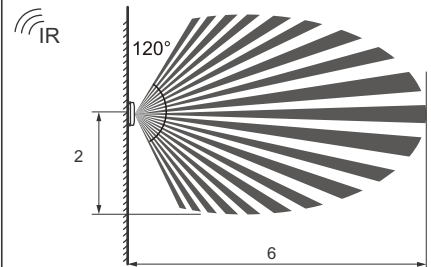
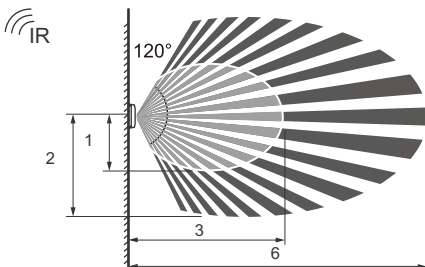
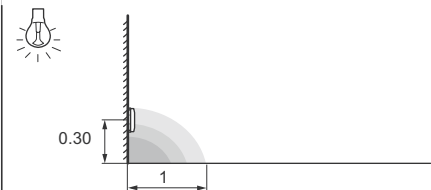
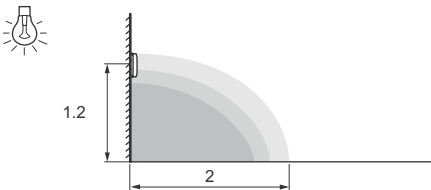
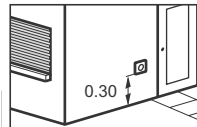
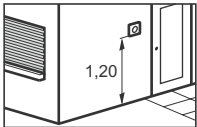
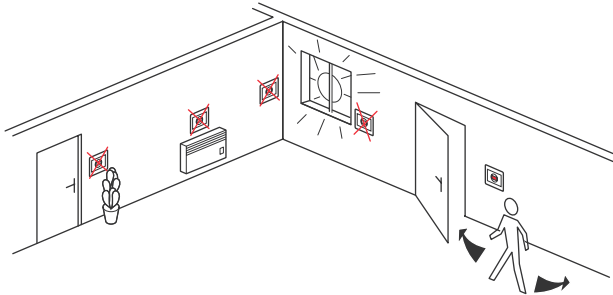

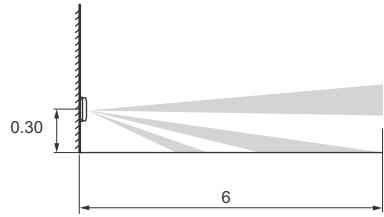
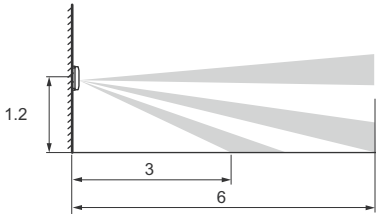

## Wiring

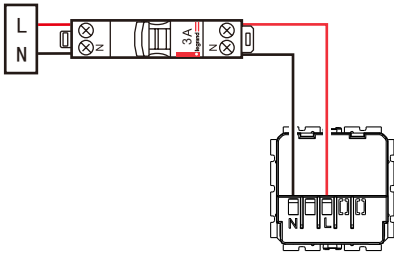

## Installation

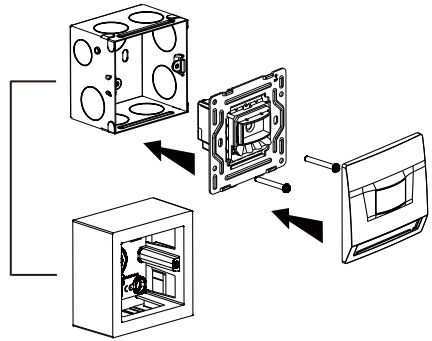

## Configuration

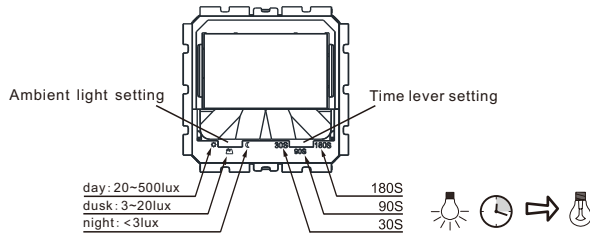

## Operation

