

⚠ Safety instructions

GB CA IN IE US SG

This product should be installed in compliance with installation rules, preferably by a qualified electrician. Incorrect installation and/or incorrect use can lead to risk of electric shock or fire.
 Before carrying out the installation, read the instructions and take account of the product's specific mounting location.
 Do not open up, dismantle, alter or modify the device except where specifically required to do so by the instructions.
 All Legrand products must be opened and repaired exclusively by personnel trained and approved by Legrand. Any unauthorised opening or repair completely cancels all liabilities and the rights to replacement and guarantees.
 Use only Legrand brand accessories.

Presentation

	 -20°C...+70°C	 -5°C...+35°C	 ≥40mm	 100-240V~ 50/60Hz
	 PIR	 day/dusk/night	 30S/90S/180S	 8 mm 1...4mm ²

Technical characteristics

	①		②		③		④		⑤		⑥		⑦	
240V~	400W	1.7A	200VA	0.85A	200VA	0.85A	200VA	0.85A	200VA	0.85A	100VA	0.42A	100VA	0.42A
100V~	200W		100VA	0.85A	100VA	0.85A	100VA	0.85A	100VA	0.85A	50VA	0.42A	50VA	0.42A

- ① Incandescent lamp
- ② Electronic step-down converter for extra low-voltage incandescent lamps(e.g.halogen)
- ③ Iron core transformer for extra low-voltage incandescent lamps(e.g.halogen)
- ④ Fluorescent lamp
- ⑤ Self-ballasted fluorescent compact lamp(CFL)
- ⑥ Self-ballasted LED lamp
- ⑦ Inductive ballast fluorescent lamp with compensator

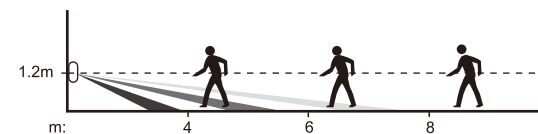

Test Temperature is 25°C.
 The detect range will be smaller when temperature is higher than 25°C.

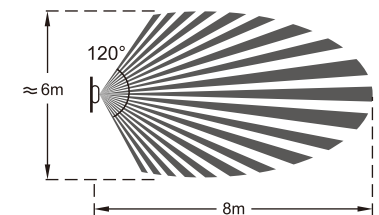

Wiring

- 1 Wire the connected switch.

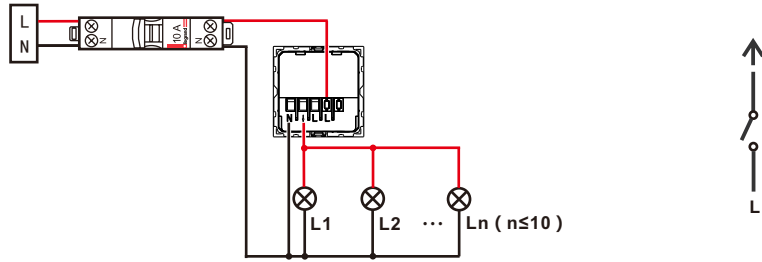

- 2 Several product control one lamp.

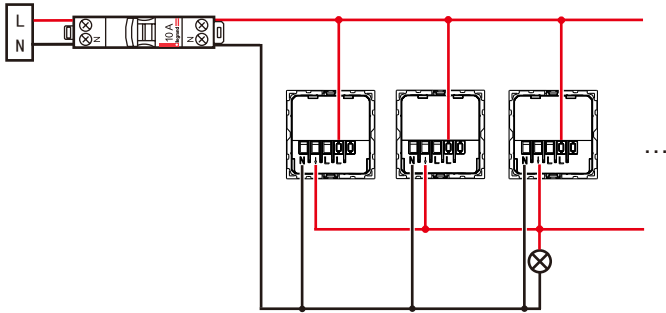

Installation

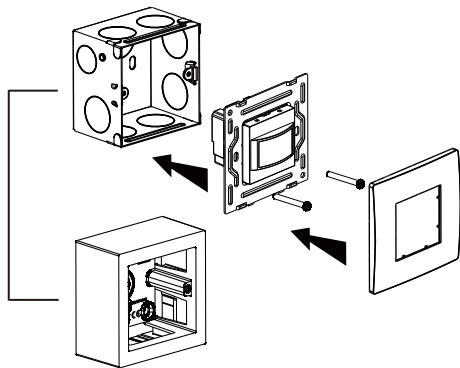

Configuration

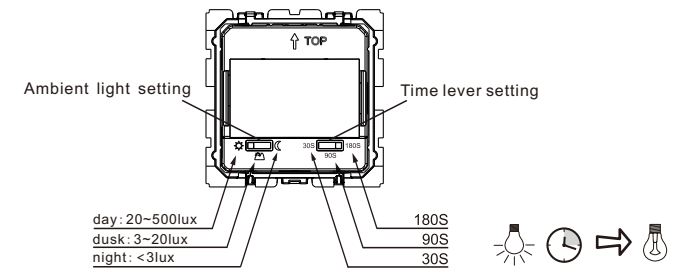
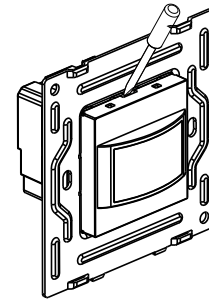

Operation

