

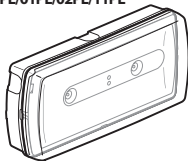

URA21^{LED}

6616 00PL/01PL/02PL/11PL

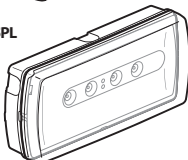
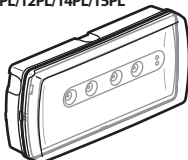

6616 05PL

6616 03PL/06PL/07PL/08PL/
09PL/10PL/12PL/14PL/15PL230 VAC 50/60 Hz -  - IP 42 / IK 07

Réf.	Lumens		NP/NM	P/M
6 616 00PL	50 lm	1h	X	
6 616 01PL	70 lm	1h	X	
6 616 02PL	100 lm	1h	X	
6 616 03PL	100 lm	1h	X	X
6 616 05PL	160 lm	1h	X	
6 616 06PL	200 lm	1h	X	X
6 616 07PL	350 lm	1h	X	X
6 616 08PL	200 lm	1h	X	
6 616 09PL	350 lm	1h	X	
6 616 10PL	100 lm	3h	X	X
6 616 11PL	90 lm	3h	X	
6 616 12PL	200 lm	2h	X	X
6 616 14PL	500 lm	1h	X	
6 616 15PL	500 lm	1h	X	X

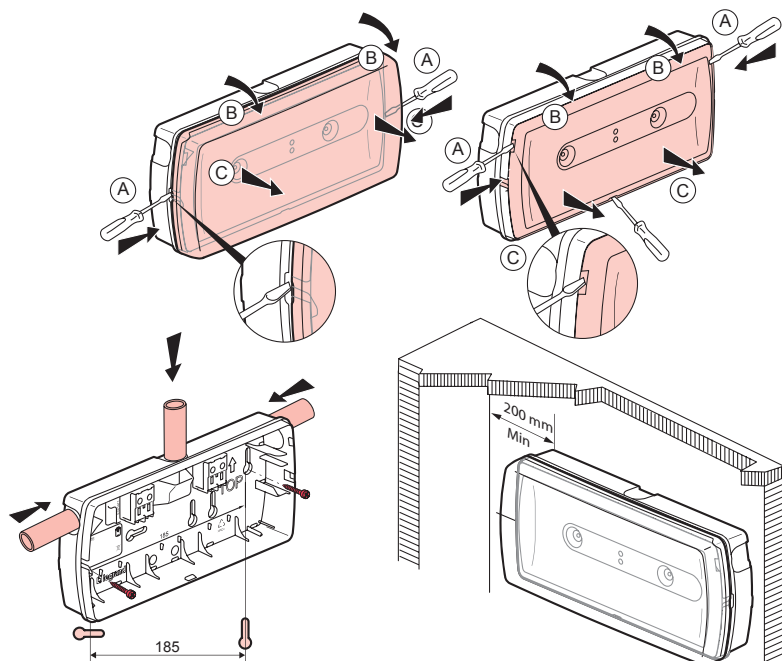

6 616 00PL/01PL/02PL/05PL/08PL/09PL/11PL/14PL

NP (NM)

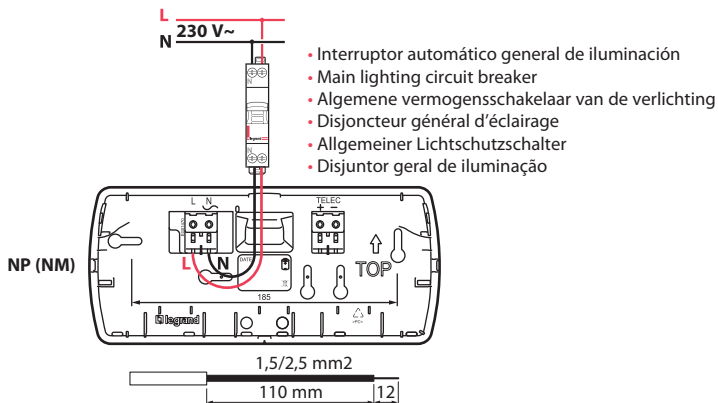

6 616 03PL/06PL/07PL/10PL/12PL/15PL

P-NP (M-NM)

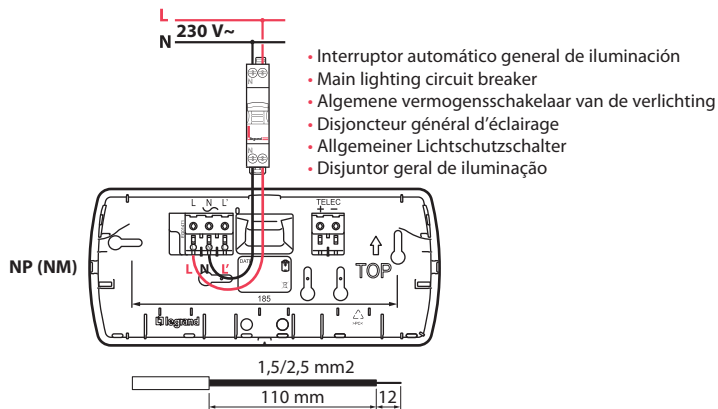
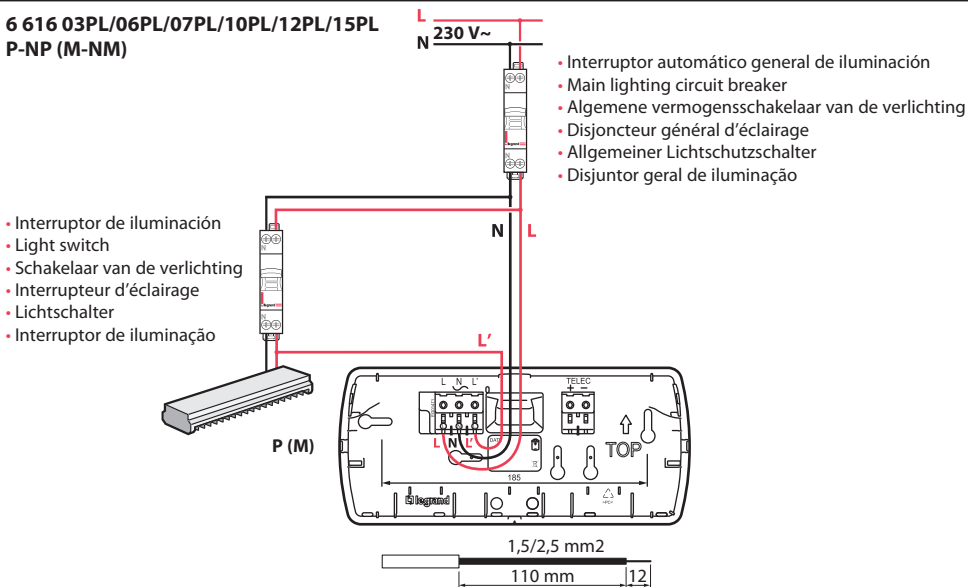

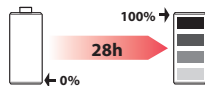
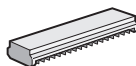
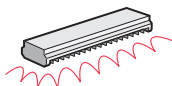

6 616 00PL/01PL/02PL/05PL/11PL



ON

NP (NM)

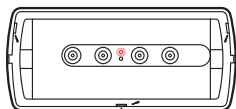
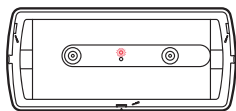

OFF

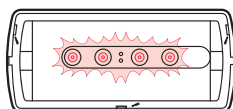
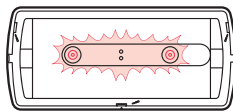

6 616 03PL/06PL/07PL/08PL/09PL/10PL/12PL/13PL/14PL/15PL



ON

P (M)

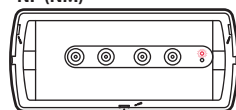
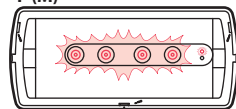

OFF

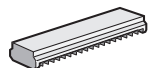
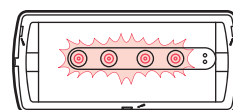
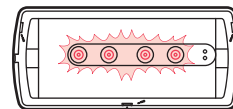

1h => 6 616 00PL/01PL/02PL/05PL
3h => 6 616 11PL



OFF

NP (NM)

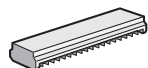
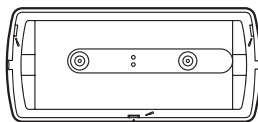
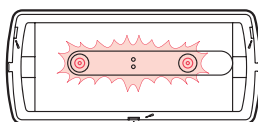
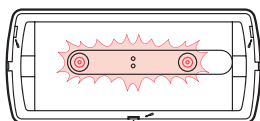

1h => 6 616 03PL/06PL/07PL/08PL/09PL/14PL/15PL
2h => 6 616 12PL
3h => 6 616 10PL



OFF

P-NP
(M-NM)

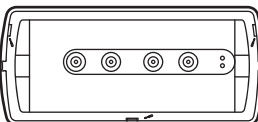
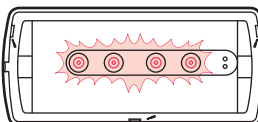
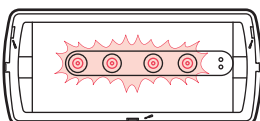

0 039 00/01

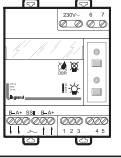

- Luminarias de emergenda en estado de reposo durante periodos de no funcionamiento del edificio
- Rest mode of the emergency lighting luminaires out of building's opening periods
- Rusttoestand van de veiligheidsverlichting buiten de operationele periode van het gebouw

- Mise à l'état de repos des luminaires d'éclairage de secours en dehors des périodes d'exploitation du bâtiment
- Ruhezustand der Einzelbatterieleuchten ausserhalb der Nutzungszeiten des Gebäudes
- Modo estado de reposo dos blocos de iluminação de emergência, quando o edifício não está no periodo de atividade

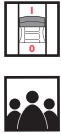

ON

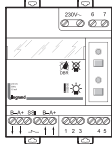

6 616 00PL/01PL/02PL/05PL/11PL

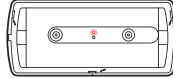

NP (NM)

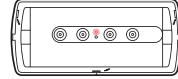

6 616 03PL/06PL/07PL/08PL/09PL/10PL/12PL/13PL/14PL/15PL

P (M)

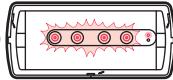

NP (NM)

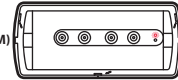

1



OFF

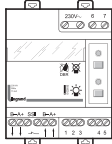

6 616 00PL/01PL/02PL/05PL/11PL

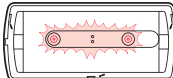

NP (NM)

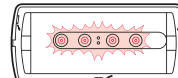

6 616 03PL/06PL/07PL/08PL/09PL/10PL/12PL/13PL/14PL/15PL

P (M)

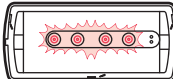

NP (NM)

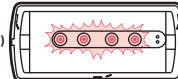

OFF

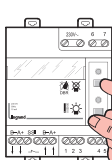

2

6 616 00PL/01PL/02PL/05PL/11PL

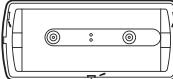

NP (NM)

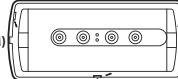

6 616 03PL/06PL/07PL/08PL/09PL/10PL/12PL/13PL/14PL/15PL

P (M)

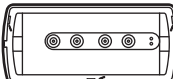

NP (NM)

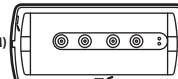

- Apagado general de luminarias de emergencia
- Complete switching off the emergency lighting

- Volledige uitschakeling van de veiligheidsverlichting
- Extinction complète des luminaires d'éclairage de secours

- Komplettes Erlöschen der Einzelbatterieleuchten
- Extinção completa da iluminação de emergência

3



ON



6 616 00PL/01PL/02PL/05PL/11PL

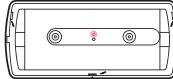

NP (NM)

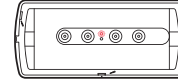

6 616 03PL/06PL/07PL/08PL/09PL/10PL/12PL/13PL/14PL/15PL

P (M)

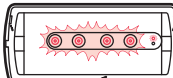

NP (NM)

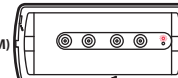

TEST



ON



6 616 00PL/01PL/02PL/05PL/11PL

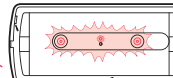

NP (NM)

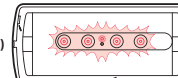

6 616 03PL/06PL/07PL/08PL/09PL/10PL/12PL/13PL/14PL/15PL

P (M)

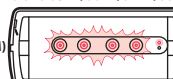

NP (NM)

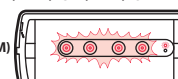

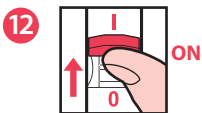
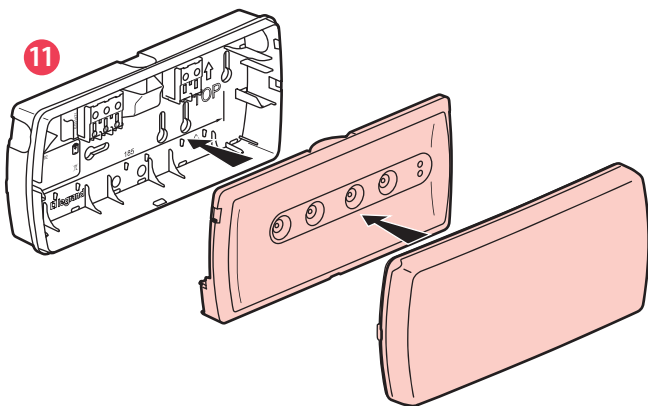
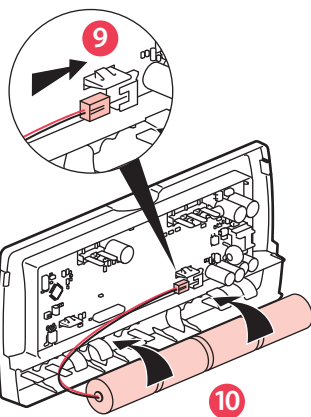
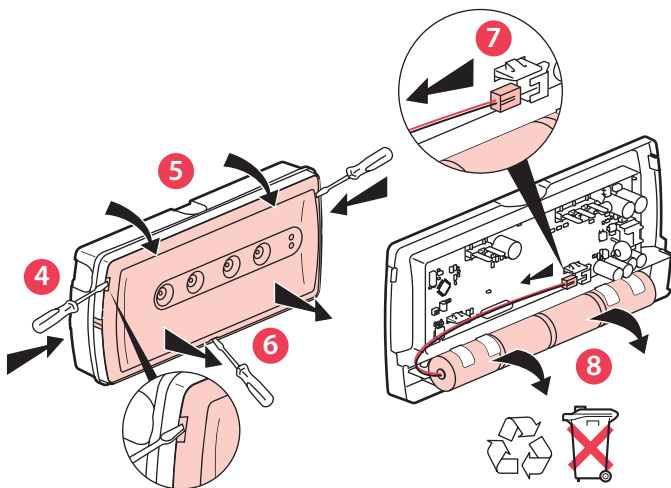
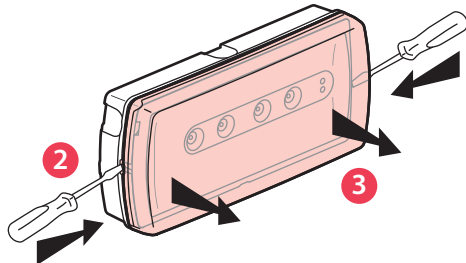
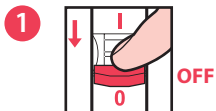
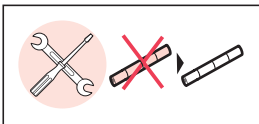

- **Nota:** Los leds no se pueden sustituir
- **Note:** LEDs can not be replaced
- **Nota:** De leds kunnen niet worden vervangen

- **Nota :** Les LEDs ne peuvent être remplacées
- **Nota:** Die LED können nicht getauscht werden
- **Nota:** As luzes LED não podem ser substituídas

⚠️ **Consignas de seguridad**

ES CL CO CR MX PE US VE

Este producto debe instalarse conforme a las normas de instalación y preferiblemente por un electricista cualificado. Una instalación incorrecta y/o una utilización incorrecta pueden entrañar riesgos de choque eléctrico o de incendio. Antes de efectuar la instalación, leer las instrucciones, tener en cuenta el lugar de montaje específico del producto. No abrir, desmontar, alterar o modificar el aparato salvo que esto se indique específicamente en las instrucciones. Todos los productos Legrand deben ser abiertos y reparados exclusivamente por personal formado y habilitado por Legrand. Cualquier apertura o reparación no autorizada anula la totalidad de las responsabilidades, derechos a sustitución y garantías. Utilizar exclusivamente los accesorios de la marca Legrand.

⚠️ **Safety instructions**

GB CA IN IE US SG

This product should be installed in compliance with installation rules, preferably by a qualified electrician. Incorrect installation and/or incorrect use can lead to risk of electric shock or fire. Before carrying out the installation, read the instructions and take account of the product's specific mounting location. Do not open up, dismantle, alter or modify the device except where specifically required to do so by the instructions. All Legrand products must be opened and repaired exclusively by personnel trained and approved by Legrand. Any unauthorised opening or repair completely cancels all liabilities and the rights to replacement and guarantees. Use only Legrand brand accessories.

⚠️ **Veiligheidsvoorschriften**

NL BE

Dit product moet in overeenstemming met de installatievoorschriften en bij voorkeur door een vakbekwame elektricien worden geïnstalleerd. Bij een onjuiste installatie en/of een onjuist gebruik bestaat het risico van elektrische schokken of brand. Lees alvorens de installatie uit te voeren de handleiding door en houd rekening met de specifieke montageplaats van het product. U mag het apparaat niet openen, demonteren of wijzigen, tenzij dat specifiek in de handleiding wordt vermeld. Alle Legrand-producten mogen uitsluitend worden geopend en gerepareerd door personeel dat door Legrand is opgeleid en bevoegd verklaard. In geval van ongeoorloofd openen of repareren wordt geen enkele aansprakelijkheid aanvaard, vervalt het recht op vervanging en zijn de garanties niet meer geldig. Gebruik uitsluitend accessoires van het merk Legrand.

⚠️ **Consignes de sécurité**

FR BE CA LU CH

Ce produit doit être installé conformément aux règles d'installation et de préférence par un électricien qualifié. Une installation incorrecte et/ou une utilisation incorrecte peuvent entraîner des risques de choc électrique ou d'incendie. Avant d'effectuer l'installation, lire la notice, tenir compte du lieu de montage spécifique au produit. Ne pas ouvrir, démonter, altérer ou modifier l'appareil sauf mention particulière indiquée dans la notice. Tous les produits Legrand doivent exclusivement être ouverts et réparés par du personnel formé et habilité par Legrand. Toute ouverture ou réparation non autorisée annule l'intégralité des responsabilités, droits à remplacement et garanties. Utiliser exclusivement les accessoires de la marque Legrand.

⚠️ **Sicherheitshinweise**

DE

Dieses Produkt darf nur durch eine Elektro-Fachkraft eingebaut werden. Bei falschem Einbau und/oder Umgang besteht Stromschlag- bzw. Brandgefahr. Vor der Installation die Anleitung lesen, den produktspezifischen Montageort beachten. Das Gerät vorbehaltlich besonderer, in der Betriebsanleitung angegebener Hinweise nicht öffnen, zerlegen, beschädigen oder abändern. Alle Produkte von Legrand dürfen ausschließlich von durch Legrand geschultes und anerkanntes Personal geöffnet und repariert werden. Durch unbefugte Öffnung oder Reparatur erlöschen alle Haftungs-, Ersatz- und Gewährleistungsansprüche. Ausschliesslich Zubehör der Marke Legrand benutzen.

⚠️ **Instruções de segurança**

PT

Este produto deve ser instalado de acordo com as regras de instalação e de preferência por um electricista qualificado. Uma instalação incorreta e/ou uma utilização incorreta podem provocar riscos de choque eléctrico ou de incêndio. Antes de efetuar a instalação, ler as instruções e ter em conta a localização adequada para a montagem do produto. Não abrir, desmontar, alterar ou modificar o aparelho salvo especificação em contrário nas instruções do produto. Todos os produtos Legrand só devem ser abertos e reparados exclusivamente por pessoal formado e autorizado pela Legrand. Qualquer abertura ou reparação não autorizada cancela todas as responsabilidades, direitos de substituição e garantias. Utilizar exclusivamente os acessórios da marca Legrand.

⚠️ **إرشادات الأمان:**

يجب تركيب هذا المنتج طبقاً لقواعد التركيب ويفضل أن يقوم بالتركيب كهربائي مؤهل. فقد يؤدي التركيب الخاطئ و/أو الاستخدام الخاطئ إلى مخاطر التعرض لصدمة كهربائية أو نشوب حريق. اقرأ النشرة قبل التركيب، وأقر مكاناً لتركيب المنتج خاصاً به. لا تفتح أو تفك أو تعدّل أو تحوّر المنتج ما لم يُشر إلى ذلك بشكل محدد في النشرة. فكل منتجات Legrand يجب فتحها وإصلاحها حصراً من قبل فنيين مدربين ومؤهلين لدى Legrand. وكل فتح أو إصلاح غير مسموح به يُبطل المسؤوليات وحقوق الاستبدال والضمانات.

لا تستخدم سوى إكسسوارات من ماركة Legrand حصراً.