

# NEMO D4-EC Multifunction Easy Connect

Manuale d'installazione • *Installation manual* • Manuel d'installation  
• *Installationsanweisungen* • Manual de instalación





### Sommario

Pericoli e avvertenze	4
Operazioni preliminari	6
Presentazione	7
Installazione	8
Utilizzo	11
Programmazione	17
Funzione di prova	27
Caratteristiche tecniche	33
Elenco abbreviazioni	48
Assistenza	48

### Contents

<i>Dangers and warnings</i>	4
<i>Preliminary operations</i>	6
<i>Presentation</i>	7
<i>Installation</i>	8
<i>Use</i>	11
<i>Programming</i>	17
<i>Connection test function</i>	27
<i>Technical characteristics</i>	36
<i>Glossary of abbreviations</i>	48
<i>Assistance</i>	48

### Sommaire

Danger et avertissement	4
Opérations préalables	6
Présentation	7
Installation	8
Utilisation	11
Programmation	17
Function de test du raccordement	27
Caractéristiques techniques	39
Lexique des abréviations	49
Assistance	49

### Summary

<i>Gefahren und Warnungen</i>	5
<i>Vorarbeiten</i>	6
<i>Presentation</i>	7
<i>Installieren</i>	8
<i>Verwendung</i>	11
<i>Programmierung</i>	17
<i>Verbindungstestfunktion</i>	27
<i>Technische Daten</i>	42
<i>Abkürzungsliste</i>	49
<i>Unterstützung</i>	49

### Resumida

Advertencia	5
Operaciones previas	6
Presentación	7
Instalación	8
Utilización Programación	11
Programación	17
Función de prueba de las conexiones	27
Características técnicas	45
Lèxico de las abreviaciones	50
Assistance	50

## • Pericoli e avvertenze

Questi apparecchi devono essere montati esclusivamente da professionisti.  
Il mancato rispetto delle indicazioni contenute nelle presenti istruzioni solleva il fabbricante da ogni responsabilità.

### **Rischi di folgorazione, ustioni o esplosione**

- L'installazione e la manutenzione di questo apparecchio devono essere effettuate esclusivamente da personale qualificato.
  - Prima di qualsiasi intervento sull'apparecchio, escludere gli ingressi di tensione.
  - Utilizzare sempre un opportuno dispositivo di rilevamento di tensione per confermare l'assenza di tensione.
  - Rimontare tutti i dispositivi, i portelli e i coperchi prima di mettere l'apparecchio sotto tensione.
  - Per alimentare questo apparecchio, utilizzare sempre la tensione nominale indicata.
- In caso di mancato rispetto di queste precauzioni, si potrebbero subire gravi ferite.

### **Rischi di deterioramento dell'apparecchio**

Attenzione a rispettare:

- Una tensione ai morsetti degli ingressi di tensione (V1,V2,V3 e N) secondo i valori indicati nella sezione "Caratteristiche tecniche".
- La frequenza di rete a 50 o 60 Hz.

## • Dangers and warnings

*This equipment must only be mounted by professionals.*

*The manufacturer shall not be held responsible for failure to comply with the instructions in this manual.*

### **Risk of electrocution, burns or explosion**

- *The device must only be installed and serviced by qualified personnel.*
  - *Prior to any work on or in the device, isolate the voltage inputs.*
  - *Always use an appropriate voltage detection device to confirm the absence of voltage.*
  - *Put all mechanisms, door and covers back in place before energising the device.*
  - *Always supply the device with the indicated rated voltage.*
- Failure to take these precautions could cause serious injuries.*

### **Risk of damaging the device**

*Chek the following:*

- *The voltage to the voltage-input terminals, (V1,V2,V3 and N) according to the values indicated in the "Technical characteristics" section.*
- *The frequency of the distribution system (50 or 60 Hz).*

## • Danger et avertissement

Le montage de ce produit ne peut être effectué que par des professionnels.

Le non respect des indications de la présente notice ne saurait engager la responsabilité du constructeur.

### **Risque d'électrocution, de brûlures ou d'explosion**

- L'installation et l'entretien de cet appareil ne doivent être effectués que par du personnel qualifié.
  - Avant toute intervention sur l'appareil, coupez les entrées tensions.
  - Utilisez toujours un dispositif de détection de tension approprié pour confirmer l'absence de tension.
  - Remplacez tous les dispositifs, les portes et les couvercles avant de mettre cet appareil sous tension.
  - Utilisez toujours la tension assignée appropriée pour alimenter cet appareil.
- Si ces précautions n'étaient pas respectées, cela pourrait entraîner des blessures graves.

### **Risque de détérioration de l'appareil**

Veillez à respecter

- Une tension aux bornes des entrées tensions (V1,V2,V3 et N) selon les valeurs indiquées dans la section "Caractéristiques techniques".
- La plage de fréquence du réseau 50 ou 60 Hz.

## • Gefahren und Warnungen

*Diese Geräte dürfen nur von Fachleuten montiert werden.  
Die Nichtbeachtung der vorliegenden Anweisungen entbindet den Hersteller von jeglicher Haftung.*

### **Stromschlag-, Verbrennungs- und Explosionsgefahr**

- Die Installation und Wartung dürfen nur von qualifizierten Fachleuten vorgenommen werden.
  - Vor jedem Eingriff in das Gerät sind die Spannungseingänge auszuschließen.
  - Verwenden Sie immer ein geeignetes Spannungsmessgerät, um die Spannungsfreiheit zu überprüfen.
  - Alle Geräte, Türen und Abdeckungen wieder montieren, bevor Sie das Gerät unter Spannung setzen.
  - Verwenden Sie immer die angegebene Nennspannung, um das Gerät mit Strom zu versorgen.
- Die Nichtbeachtung dieser Vorsichtsmaßnahmen kann zu schweren Verletzungen führen.*

### **Beschädigungsgefahr des Gerätes**

*Bitte beachten:*

- Eine Spannung an den Klemmen der Spannungseingänge (V1, V2, V3 und N) entsprechend den im Kapitel "Technische Daten" angegebenen Werten.
- Netzfrequenz 50/60 Hz

## • Advertencia

El montaje de esto materiales sólo puede ser efectuado por profesionales.  
No respetar las indicaciones del presente manual exime de responsabilidad al fabricante.

### **Riesgo de electrocución, de quemaduras o de explosión**

- La instalación y mantenimiento de este aparato debe ser efectuado por personal cualificado.
- Antes de cualquier intervención en el aparato, cortar sus entradas de tensión.
- Utilizar siempre un dispositivo de detección de tensión apropiado para asegurar la ausencia de tensión.
- Volver a colocar todos los dispositivos, tapas y puertas antes de poner el aparato en tensión.
- Utilizar siempre la tensión asignada apropiada para alimentar el aparato.

No respetar estas precauciones podría entrañar un serio riesgo de producir heridas graves.

### **Riesgo de deterioros de aparato**

Se ha de respetar:

- Una tensión en los bornes de las entradas de tensión (V1, V2, V3 y N) según los valores indicados en la sección "Características técnicas".
- La frecuencia de red a 50/60 Hz

## • Operazioni preliminari

Per la sicurezza del personale e del materiale, è indispensabile leggere attentamente il contenuto del presente libretto prima della messa in servizio.

Al momento del ricevimento della scatola contenente il dispositivo, è necessario verificare i seguenti punti:

- lo stato dell'imballo;
- l'assenza di danneggiamenti o rotture dovuti al trasporto;
- la rispondenza tra codice dell'apparecchio e codice ordinato;
- la presenza nell'imballo sia dell'articolo che del foglio istruzioni.

## • Preliminary operations

*For personnel and product safety read the contents of these operating instructions carefully before connecting.*

*Check the following points as soon as you receive the box containing the device:*

- the packing is in good condition;*
- the product has not been damaged or broken during transport;*
- the product reference number conforms to your order;*
- the package contains both the item and the operating instructions.*

## • Opérations préalables

Pour la sécurité du personnel et du matériel, il est impératif de bien s'imprégner du contenu de cette notice avant la mise en service.

Au moment de la réception du colis contenant le produit, il est nécessaire de vérifier les points suivants :

- l'état de l'emballage ;
- le produit n'a pas eu de dommage pendant le transport ;
- la référence de l'appareil est conforme à votre commande
- l'emballage comprend le produit ;
- une notice d'utilisation.

## • Vorarbeiten

*Für die Sicherheit von Personen und Material ist es unerlässlich, den Inhalt dieser Anleitung vor der Inbetriebnahme aufmerksam zu lesen. Nach Erhalt der Schachtel mit dem Gerät sind die folgenden Punkte zu überprüfen:*

- Zustand der Verpackung;*
- Das Fehlen von Beschädigungen oder Bruch durch den Transport;*
- die Übereinstimmung zwischen Gerätecode und bestelltem Code;*
- Vorhandensein in der Verpackung sowohl des Artikels als auch der Gebrauchsanweisung.*

## • Operaciones previas

Para la seguridad del personal y del material, será imperativo conocer perfectamente el contenido de este manual antes de su puesta en funcionamiento.

Al recibir el paquete que contiene el producto será necesario verificar los aspectos siguientes:

- estado del embalaje;
- que el producto no se haya dañado durante el transporte;
- que la referencia del aparato esté conforme con su pedido;
- el embalaje incluye el producto;
- el manual de utilización.

### • Presentazione

1. Display LCD retroilluminato
2. Valori
3. Fase
4. Ingresso connessione rapida per sonde Rogowski
5. Morsetti di collegamento uscita impulsi o connessione Modbus/Mbus
6. Morsetto d'ingresso per il conteggio dell'energia su doppia tariffa
7. Unità di misura
8. Tastiera composta da 4 pulsanti a doppia funzionalità (visualizzazione/configurazione)
9. Visualizzatore del contatore orario e delle energie

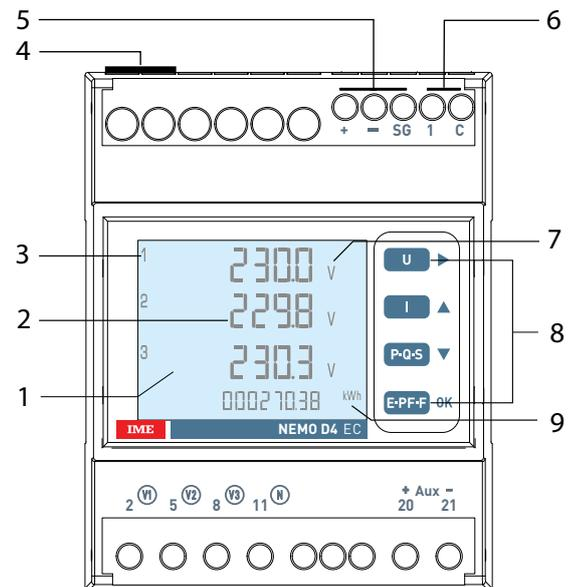

### • Presentation

1. Backlighted LCD display
2. Values
3. Phase
4. Quick-connection input for Rogowski probes
5. Pulse output connection terminal or Modbus/Mbus connection
6. Input terminal for energy metering on double tariff
7. Measurements units
8. Keypad made up of 4 double function pushbuttons (display/configurations)
9. Hour meter and energy display

### • Presentation

1. LCD-Display mit Hintergrundbeleuchtung
2. Werte
3. Phase
4. Schnellanschluss für Rogowski-Sonden
5. Anschlussklemmen Impulsausgang oder Ausgang Modbus/Mbus
6. Eingangsklemme zum Zählen von Energie im Doppetarif
7. Maßeinheit
8. Tastatur bestehend aus 4 Tasten mit Doppelfunktion (Display/Konfiguration)
9. Anzeige des Zeitzählers und der Energien

### • Présentation

1. Afficheur LCD rétroéclairé
2. Valeurs
3. Phase
4. Connexion rapide pour les sondes Rogowski
5. Bornier sortie impulsions ou branchement Modbus/Mbus
6. Bornier entrée pour le comptage de l'énergie en double tarif
7. Unité de mesure
8. Clavier constitué de 4 boutons à deux fonctions (visualisation/configuration)
9. Compteurs d'énergie et horaire

### • Presentación

1. Pantalla LCD retroiluminada
2. Valores
3. Fase
4. Conexión rápida para sondas Rogowski
5. Borne de conexión de la salida de impulsos o Modbus/Mbus
6. Borne de entrada para contabilizar la energía en doble tarifa
7. Unidad de medida
8. Teclado compuesto por 4 botones con doble función (visualización/configuración)
9. Visualización del contador horario y de las energías

## • Installazione • Installation • Installation • Installieren • Instalación

### • Prescrizioni

- Evitare la vicinanza con sistemi generatori di perturbazioni elettromagnetiche.

### • Recommendations

- Avoid proximity to systems which generate electromagnetic interference.

### • Recommendations

- Éviter la proximité avec des systèmes générateurs de perturbations électromagnétiques

### • Collegamento

Per la coppia di serraggio massima dei morsetti vedere la tabella

### • Connection

For the maximum terminal torque see the table

### • Raccordement

Pour le couple de serrage maximal des bornes voir le tableau

### • Anschluss

Das maximale Anzugsmoment der Klemmen finden Sie in der Tabell

### • Conexión

Para el par de apriete máximo de los bornes, consultar la tabla

### • Rezepte

- Nähe zu Generatorsystemen vermeiden elektromagnetische Störungen.

### • Prescripciones

- Evitar la proximidad con sistemas que generan interferencias electromagnéticas.

U	3x230/3x400Vac ±15%	CAT III
 Only MBus	6,5 / 7 mm MAX 1 x 2,5 mm <sup>2</sup> Rigid 1 x 2,5 mm <sup>2</sup> Flexible 1 x 1,5 mm <sup>2</sup> 1 x 4 mm <sup>2</sup>	Recommended torque 0,5Nm max. 0,6Nm 2,5mm PH0 
	$I_{min} = 0,5 A$ $I_n = 10 A$ $I_{max} = 63 A$ $I_{min} = 1 A$ $I_n = 20 A$ $I_{max} = 125 A$	
I	<b>MKD4R63DT - MKD4R63MT</b> 1,5...10 mm <sup>2</sup> / Ø 4,8 mm MAX 1,5...16 mm <sup>2</sup> / Ø 4,8 mm	
	<b>MKD4R125DT - MKD4R125MT</b> 16...50 mm <sup>2</sup> / Ø 6,4...12,4 mm MAX 25...70 mm <sup>2</sup> / Ø 6,4...12,4 mm	
	<b>MKD4R63DT - MKD4R63MT</b> 16 mm <sup>2</sup> / Ø 9,3 mm 25 mm <sup>2</sup> / Ø 9,3 mm	
	<b>MKD4R125DT - MKD4R125MT</b> 50 mm <sup>2</sup> / Ø 15,3 mm 70 mm <sup>2</sup> / Ø 15,3 mm	
	350 mm	
cl.	Wh(E <sub>a</sub> ):1 (IEC/EN 62053-21) varh(E <sub>v</sub> ):2 (IEC/EN 62053-23)	
	(-20°C) - (60°C)	

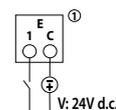
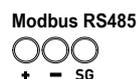
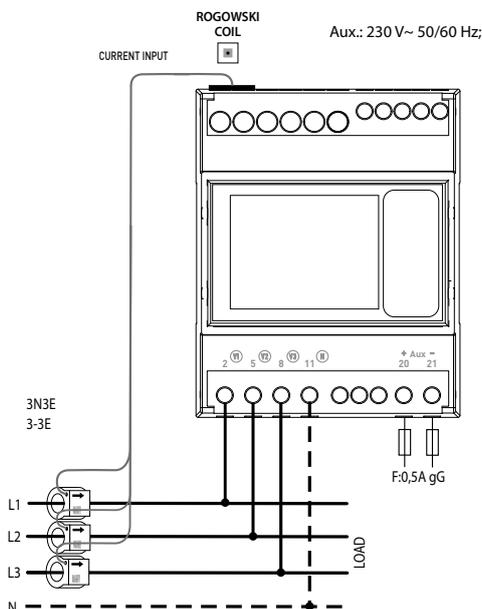

• **Installazione • Installation • Installation • Installieren • Instalación**

• **Schema di collegamento • Wiring diagram • Schéma de câblage • Anschlussbilder**  
• **Esquema de conexión**

- Nei cablaggi rispettare scrupolosamente lo schema di inserzione; una inesattezza nei collegamenti può pregiudicare il corretto funzionamento o causare danni allo strumento.
- *During wiring carefully comply with the connection diagram; a connection error may affect proper operation, or cause damage to the device.*
- Veuillez respecter scrupuleusement le schéma de connexion; une erreur de connexion peut nuire au bon fonctionnement, ou causer des dommages à l'appareil.
- *Beachten Sie bei der Verdrahtung unbedingt das Anschlusschema; Ungenauigkeiten in den Anschlüssen können zu Fehlbedienungen oder Schäden am Gerät führen.*
- En los cableados, se ha de respetar rigurosamente el esquema de inserción; si las conexiones no son precisas, se puede perjudicar el funcionamiento correcto o causar daños al instrumento.

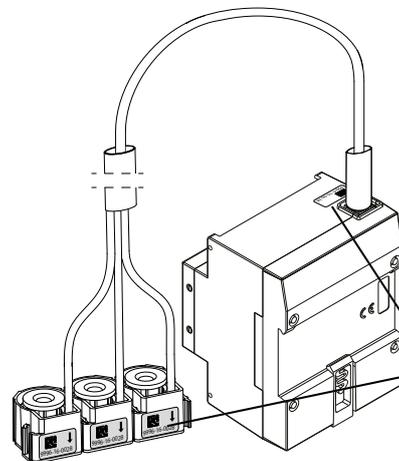
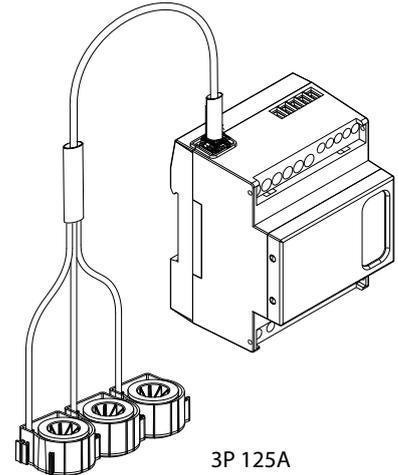
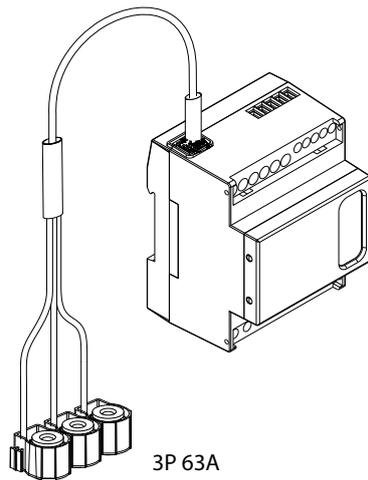

XXXX-yy-zzzz = XXXX-yy-zzzz

- Nota:** Il numero seriale identifica unicamente la coppia, Sonda + Dispositivo  
**Note:** The serial number identifies only the pair, Probe + Device  
**Note:** Le numéro de série identifie uniquement la paire, sonde + appareil  
**Note:** Die Seriennummer identifiziert nur das Paar Probe + Device  
**Nota:** El número de serie identifica solo el par, Sonda + Dispositivo

Aux.: 230 V AC 50/60 Hz;  
F: 0,5 A gG

• **Installazione • Installation • Installation • Installieren • Instalación**

- **Schema di collegamento RS485 • RS485 wiring diagram • Schéma de branchement RS485**
- **Anschlussbilder RS485 • Esquema de conexión RS485**

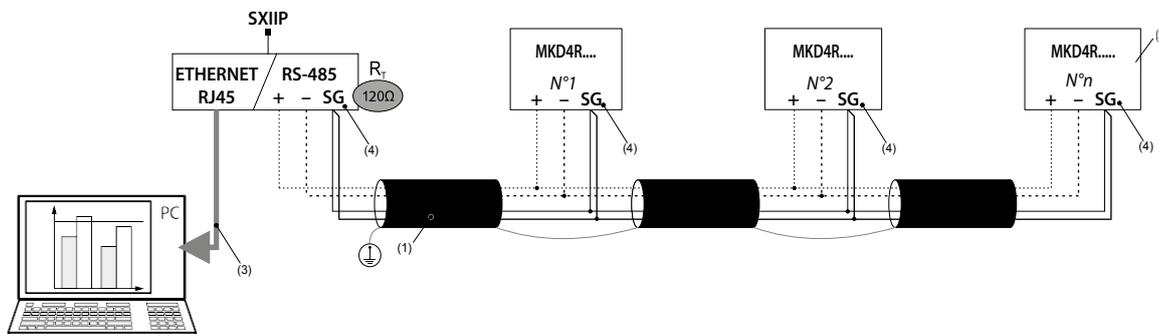

- (1) BELDEN 9842, BELDEN 3106A (or/equivalent) max. 1000 m, Cat. 6 (FTP/UTP) max. 50 m
- (2) Resistenza di terminazione da 120Ω interna allo strumento (impostabile dal menù di SETUP)
  - 120Ω terminating resistor inside the instrument (it can be set in the SETUP menu)
  - Résistance de terminaison de 120 Ω intégrée à l'instrument (réglable dans le menu de RÉGLAGE)
  - 120Ω Abschlusswiderstand intern im Gerät (einstellbar über das SETUP-Menü)
  - Resistencia de terminación de 120Ω interna en el instrumento (ajustable en el menú SETUP)
- (3) Ethernet: Cat. 6 (FTP/UTP)
- (4) Il morsetto "SG" non va assolutamente collegato a terra
  - The terminal "SG" must never be earthed
  - La borne "SG" ne doit jamais être reliée à la terre
  - Die Klemme "SG" darf niemals geerdet werden
  - El terminal "SG" nunca debe estar conectado a tierra

- **Schema di collegamento RS485 Modbus con Mini Web Server**
- **RS485 Modbus wiring diagram with Mini web Server**
- **Schéma de branchement RS485 Modbus avec Mini Web Server**
- **Anschlussbilder RS485 Modbus Mini Web Server**
- **Esquema de conexión RS485 Modbus con Mini Web Server**

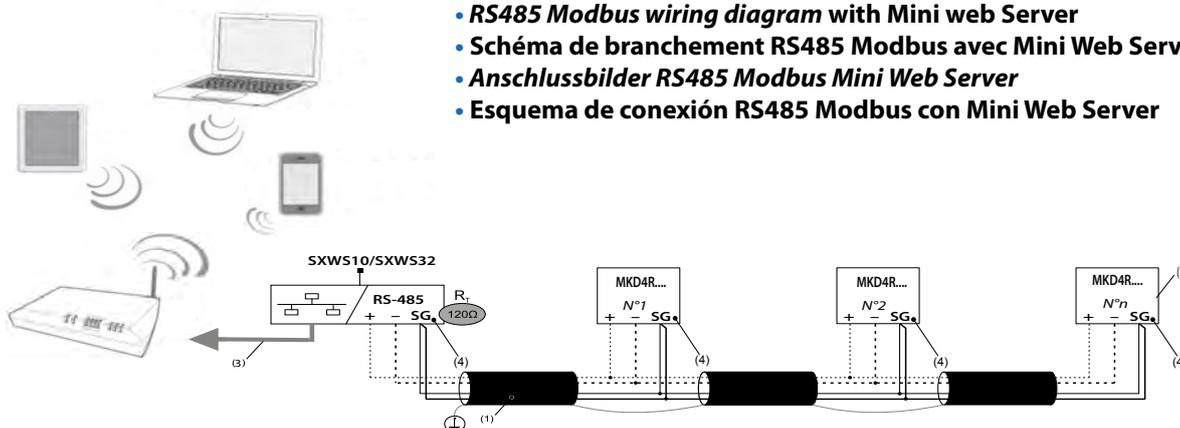

- **Schema di collegamento Mbus**
- **Mbus Modbus wiring diagram**
- **Schéma de branchement Mbus**
- **Anschlussbilder Mbus**
- **Esquema de conexión Mbus**

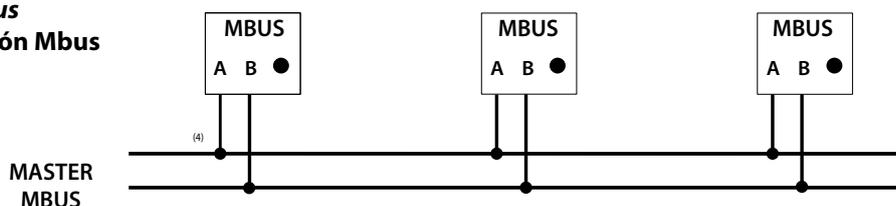

- (4) Collegamenti non polarizzati. Un cavo telefonico standard a due fili (JYStY N°2\*0.8 mm)  
Non-polarized connections. A two-wire standard telephone cable (JYStY N°2\*0.8 mm)  
Connexions non polarisées. Un câble téléphonique standard à deux fils (JYStY N°2\*0.8 mm)  
Nicht polarisierte Verbindungen. Ein zweidrahtiges Standardtelefonkabel (JYStY N°2\*0.8 mm)  
Conexiones no polarizadas. Un cable telefónico estándar de dos hilos (JYStY N°2\*0.8 mm)

**• Utilizzo • Use • Utilisation • Verwendung • Utilización**

**• Navigazione pagine di visualizzazione**

Il dispositivo è dotato di una tastiera frontale a 4 tasti a doppia funzionalità (visualizzazione/configurazione) e di un display LCD retroilluminato, su cui è riportata la funzione eseguita dal tasto corrispondente.

**• Navigation display pages**

The device is equipped of the keypad with 4 double-function keys (display/configurations) and a backlighted LCD display, that showing the function performed by the corresponding key.

**• Pages d'affichage de navigation**

L'appareil est équipé du clavier frontal à 4 touches à deux fonctions (visualisation/configuration) et d'un afficheur LCD rétroéclairé indiquant la fonction remplie par la touche correspondante.

**• Durchsuchen von Anzeigeseiten**

Das Gerät ist mit eine 4-Tasten-Tastatur mit Doppelfunktion (Display/Konfiguration) und ein hintergrundbeleuchtetes LCD Display ausgestattet. Hier wird die von der entsprechenden Taste ausgeführte Funktion angezeigt.

**• Navegando por páginas de visualización**

El dispositivo está equipado un teclado frontal de 4 teclas con doble función (visualización/configuración) y una pantalla LCD retroiluminada, que muestra la función realizada por la tecla correspondiente.

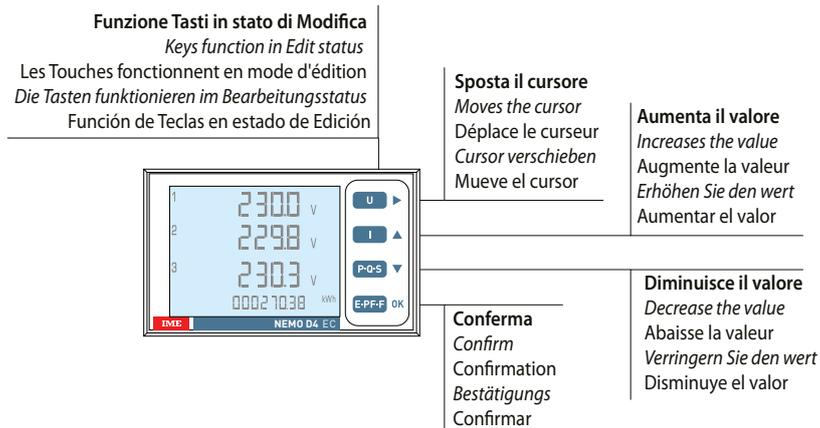

- **Azzeramento**
- **Reset**
- **Remise à zéro**
- **Rücksetzen**
- **Volver a cero**

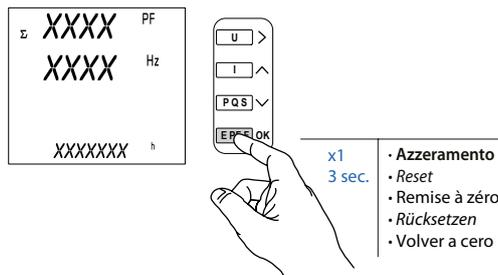

## • Utilizzo • Use • Utilisation • Verwendung • Utilización

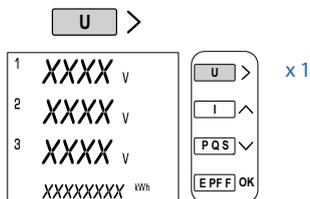

Tensione di fase - Energia attiva  
*Phase voltage - Active energy*  
 Tension simple - Energie active  
*Phasenspannung - Wirkenergie*  
 Tensión de fase - Energía activa

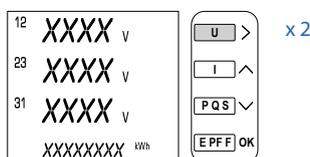

Tensione concatenata - Energia attiva  
*Linked voltage - Active energy*  
 Tension composée - Energie active  
*Verkettete Spannung - Wirkenergie*  
 Tensión concatenada - Energía activa

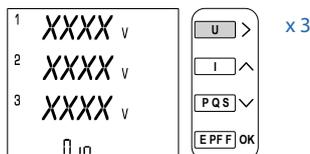

Tensione - valore minimo  
*Voltage - minimum value*  
 Tension - valeur minimale  
*Spannung - Mindestwert*  
 Tensión - valor mínimo

**EPFF OK** x 1  
 3sec

Reset  
*Reset to zero*  
 Remise à zéro  
 Rücksetzen  
 Volver a cero

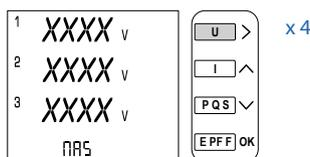

Tensione - valore massimo  
*Voltage - maximum value*  
 Tension - valeur maximale  
*Spannung - Maximalwert*  
 Tensión - valor máximo

**EPFF OK** x 1  
 3sec

Reset  
*Reset to zero*  
 Remise à zéro  
 Rücksetzen  
 Volver a cero

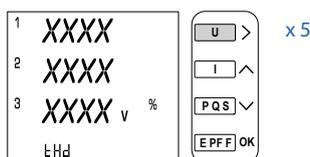

THD di Tensione  
*Voltage THD*  
 THD de Tension  
*THD de Tensión*  
 THD Tensão

• Utilizzo • Use • Utilisation • Verwendung • Utilización

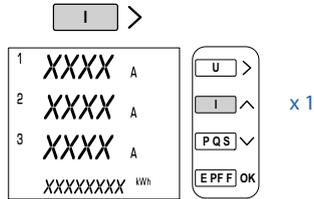

Corrente di fase - Energia attiva  
Phase current - Active energy  
Courant de phase - Energie active  
Phasenstrom - Wirkenergie  
Corriente de fase - Energia activa

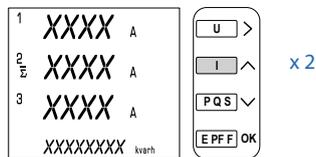

Corrente media di fase - Energia reattiva  
Average phase current - Reactive energy  
Courant moyen de phase - Energie réactive  
Phasenmittelstrom - Blindenergie  
Corriente media de fase - Energia reactiva

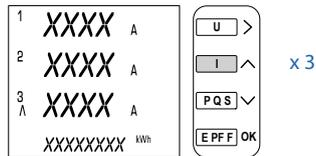

Picco corrente media di fase - Energia attiva  
Max. average phase current - Active energy  
Val. Maxi. courant moyen de phase - Energie active  
Mittlere Phasenstromspitze - Reaktive Energie  
Corriente máxima media de fase - Energia activa

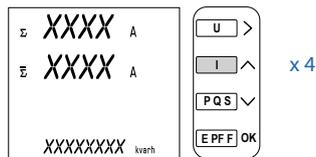

Correte di neutro - Media delle 3 correnti - Energia reattiva  
Neutral current - Average of the 3 currents - Reactive energy  
Courant du neutre - Moyenne des 3 courants - Energie réactive  
Neutralstrom - Durchschnitt der 3 Ströme - Blindarbeit  
Corriente de neutro - Promedio de las 3 corrientes - Energia reactiva

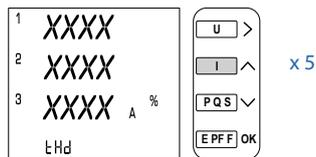

THD corrente di fase  
Phase currents THD  
THD des courants de phase  
THD-Phasenstrom  
THD de las corrientes de fase

EPFF OK x 1  
3sec  
Reset  
Reset to zero  
Remise à zéro  
Rücksetzen  
Volver a cero

## • Utilizzo • Use • Utilisation • Verwendung • Utilización

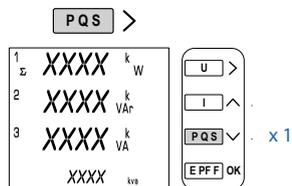

Potenza trifase attiva, reattiva, apparente e distortente  
*Active, reactive, apparent and deforming three-phase power*  
 Puissance triphasée active, réactive, apparente et déformante  
*Aktive, reaktive, scheinbare und verzerrende dreiphasige Leistung*  
 Potencia trifásica activa, reactiva, aparente y deformante

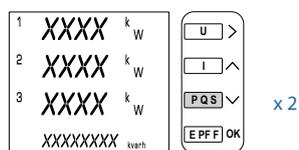

Potenza attiva di fase - Energia reattiva  
*Phase active power - Reactive energy*  
 Puissance active de phase - Energie réactive  
*Wirkphasenleistung - Blindarbeit*  
 Potencia activa de fase - Energía reactiva

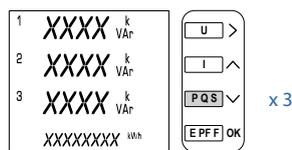

Potenza reattiva di fase - Energia attiva  
*Phase reactive power - Active energy*  
 Puissance réactive de phase - Energie active  
*Phasenblindleistung - Wirkenergie*  
 Potencia reactiva de fase - Energía activa

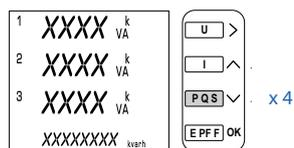

Potenza apparente di fase - Energia reattiva  
*Phase apparent power - Reactive energy*  
 Puissance apparente de phase - Energie réactive  
*Scheinphasenleistung - Blindenergie*  
 Potencia aparente de fase - Energía reactiva

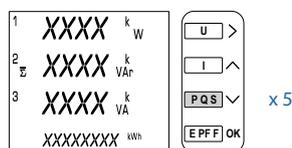

Potenza media attiva, reattiva e apparente - Energia attiva  
*Active, reactive and apparent average power - Active energy*  
 Puissance moyenne active, réactive et apparente - Energie active  
*Mittlere Wirk-, Blind- und Scheinleistung - Wirkarbeit*  
 Potencia media activa, reactiva y aparente - Energía activa

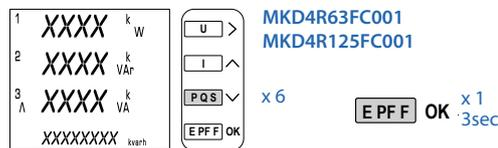

Picco potenza media attiva, reattiva e apparente  
 - Energia reattiva  
*Max. active, reactive and apparent average power*  
 - Reactive energy  
 Val. Maxi. puissance moyenne active, réactive et apparente  
 - Energie réactive  
*Spitzendurchschnitt der Wirk-, Blind- und Scheinleistung*  
 - Reaktive Energie  
 Potencia máxima media activa, reactiva y aparente  
 - Energía reactiva

Reset  
 Reset to zero  
 Remise à zéro  
 Rücksetzen  
 Volver a cero

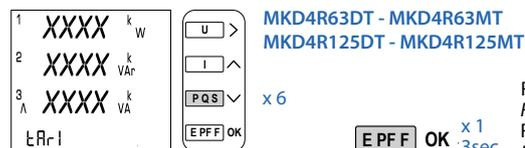

Picco di potenza media T1  
*Power Max. demand T1*  
 Pointe de puissance moyenne T1  
*Mittlere Leistungsspitze T1*  
 Pico de potencia promedio T1

Reset  
 Reset to zero  
 Remise à zéro  
 Rücksetzen  
 Volver a cero

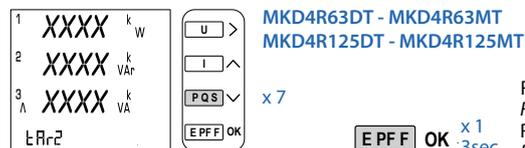

Picco di potenza media T2  
*Power Max. demand T2*  
 Pointe de puissance moyenne T2  
*Mittlere Leistungsspitze T2*  
 Pico de potencia promedio T2

Reset  
 Reset to zero  
 Remise à zéro  
 Rücksetzen  
 Volver a cero

• Utilizzo • Use • Utilisation • Verwendung • Utilización

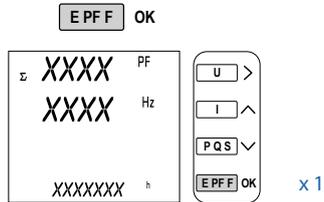

**EPFF OK** x 1  
3sec  
Reset  
Reset to zero  
Remise à zéro  
Rücksetzen  
Volver a cero

Fattore di potenza trifase - Frequenza - Contatore  
Three-phase power factor - Frequency - Hour counter  
Facteur de puissance triphasée - Fréquence - Compteur horaire  
Dreiphasen-Leistungsfaktor - Frequenz - Betriebsstundenzähler  
Factor de potencia trifásico - Frecuencia - Contador horario

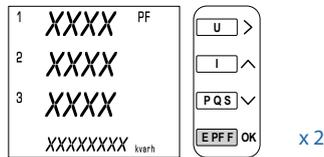

Fattore di potenza di fase - Energia reattiva  
Phase power factor - Reactive energy  
Facteur de puissance de phase - Energie active  
Phasenleistungsfaktor - Blindenergie  
Factor de potencia de fase - Energía reactiva

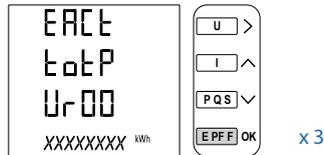

Energia attiva totale positiva - Numero azzeramenti contatore  
Total positive active energy - Number of counter resets  
Energie active totale positive - Nombre de remises à zero du compteur  
Positive Gesamtwirkleistung - Anzahl der Nullen  
Energía activa total positiva - Número de restablecimientos del contador

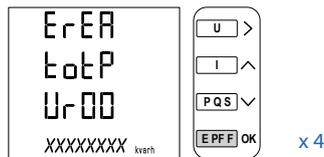

Energia reattiva totale positiva - Numero azzeramenti contatore  
Total positive reactive energy - Number of counter resets  
Energie réactive totale positive - Nombre de remises à zero du compteur  
Positive Gesamtblindenergie - Anzahl der Nullen  
Energía reactiva total positiva - Número de restablecimientos del contador

## • Utilizzo • Use • Utilisation • Verwendung • Utilización



Energia attiva totale negativa - Numero azzeramenti contatore  
*Total negaive active energy - Number of counter resets*  
 Energie active totale negative - Nombre de remises à zero du compteur  
*Negative Gesamtenergie - Anzahl der Nullen des Zählers*  
 Energía activa total negativa - Número derestablecimientos del contador



Energia reattiva totale negativa - Numero azzeramenti contatore  
*Total negaive reactive energy - Number of counter resets*  
 Energie réactive totale negative - Nombre de remises à zero du compteur  
*Negative Gesamtblindenergie - Anzahl der Nullen*  
 Energía reactiva total negativa - Número de restablecimientos del contador



MKD4R63DT - MKD4R63MT  
 MKD4R125DT - MKD4R125MT

Energia attiva positiva T1  
*Positive active energy T1*  
 Energie active positive T1  
*Positive Wirkleistung T1*  
 Energía activa positiva T1



MKD4R63DT - MKD4R63MT  
 MKD4R125DT - MKD4R125MT

Energia attiva positiva T2  
*Positive active energy T2*  
 Energie active positive T2  
*Positive Wirkleistung T2*  
 Energía activa positiva T2

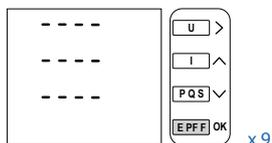

Pagina personalizzata  
*Custom page*  
 Page personnalisée  
*Eigene Seite*  
 Página personalizada

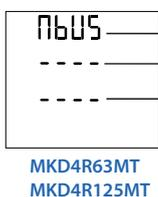
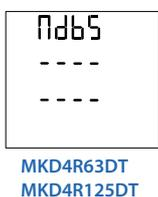
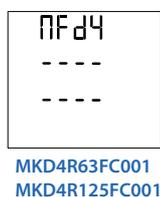

Comunicazione / *Communication* / *Communication* / *Kommunikation* / *Comunicación*  
 Connessione / *Connection* / *Connexion* / *Anschluss* / *Conexión*  
 Versione / *Version* / *Versión* / *Versión* / *Versión*

## • Programmazione • Programming • Programmation • Programmierung • Programación

- Modalità visualizzazione dei Parametri Programmabili già impostati
- Display mode of the Programmable Parameters already Set
- Mode d'affichage des Paramètres Programmables déjà définis
- Anzeigemodus der bereits eingestellten Programmierbare Parameter
- Modo de visualización de los Parámetros Programables ya configurados

- Premendo contemporaneamente i tasti **I** **PQS** x 3 sec, si entra in modalità di visualizzazione dei Parametri di Programmazione già impostati
- Pressing the keys simultaneously **I** **PQS** x 3 sec, you enter the display mode of the programming parameters already set
- En appuyant simultanément sur les touches **I** **PQS** x 3 sec, vous entrez dans le mode d'affichage des paramètres de programmation déjà définis
- Durch Drücken der Tasten gleichzeitig **I** **PQS** x 3 sec, Sie gelangen in den Anzeigemodus der bereits eingestellten Programmierparameter
- Presionando las teclas simultáneamente **I** **PQS** x 3 sec, ingresa al modo de visualización de los parámetros de programación ya configurados

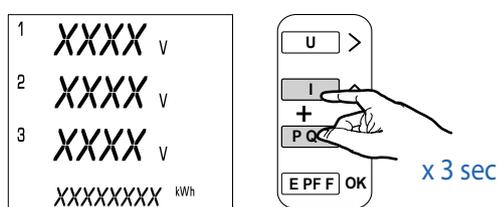

- **Nota:**  
- Non si deve essere nelle pagina di "Logo"
- **Note:**  
- You don't have to be on the "Logo" page
- **Note:**  
- Vous ne devriez pas être dans le « Logo »
- **Note:**  
- Sie müssen nicht auf der Seite "Logo" sein
- **Nota:**  
- No tiene que estar en la página "Logo tipo"

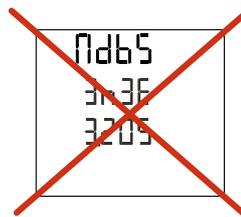

- I Parametri Programmabili sono • The Programmable Parameters are • Les Paramètres Programmables sont
- Die Programmierbare Parameter sind • Los Parámetros Programables son

### Modbus/Mbus

Pagina visualizzazione personale / Rete / Tempo d'integrazione delle Correnti e Potenze / Contatore orario  
*Customized display page / Network / Integration time of Currents and Power / Hour run meter*  
 Page d'affichage personnalisée / Réseau / Temps d'intégration des Courants et Puissances / Compteur horaire  
*Kundenspezifische anzeigeseite / Netzwerk / Integrationszeit für Strommittelwert und Leistungsmittelwert / Stundenzähler*  
 Página de visualización personalizada / Red / Tiempo de integración de la Corriente eléctrica y Potencias / Contador Horario

### Modbus

Indirizzo di comunicazione / Velocità di comunicazione / Bit di Parità / Resistenza di terminazione  
*Communication address / Communication speed / Parity Bit / Termination resistance*  
 Adresse de communication / Vitesse de communication / Bit de parité / Résistance de terminaison  
*Kommunikation adresse / Übertragungswindigkeit / Paritätsbit / Abschlusswiderstand*  
 Dirección de comunicación / Velocidad de comunicación / Bit de paridad / Resistencia de terminación

### Mbus

Indirizzo Primario / Velocità di comunicazione / Indirizzo Secondario  
*Primary address / Communication speed / Secondary address*  
 Adresse Principale / Vitesse de communication / Adresse Secondaire  
*Primäre Adresse / Übertragungswindigkeit / Sekundäre Adresse*  
 Domicilio primario / Velocidad de comunicación / Domicilio secundario

## • Programmazione • Programming • Programmation • Programmierung • Programación

- Modifica dati di SETUP
- Changing SETUP data
- Modification des données SETUP
- Ändern der Setup-Daten
- Modificación de los datos de configuración



- Premendo contemporaneamente i tasti   x 3 sec, si accede alla PASSWORD
- Pressing the keys simultaneously   x 3 sec, the PASSWORD is accessed
- En appuyant simultanément sur les touches   x 3 sec, vous accédez au MOT DE PASSE
- Durch Drücken der Tasten gleichzeitig   x 3 sec, wird auf das PASSWORD zugegriffen
- Presionando las teclas simultáneamente   x 3 sec, se accede a la CONTRASEÑA.

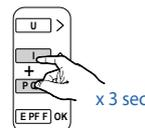

- La PASSWORD è richiesta solo al primo accesso di SETUP
- PASSWORD is required only at the first SETUP access
- MOT DE PASSE n'est requis qu'au premier accès SETUP
- PASSWORD wird nur beim ersten SETUP-Zugriff benötigt
- La CONTRASEÑA se requiere solo en el primer acceso de CONFIGURACIÓN

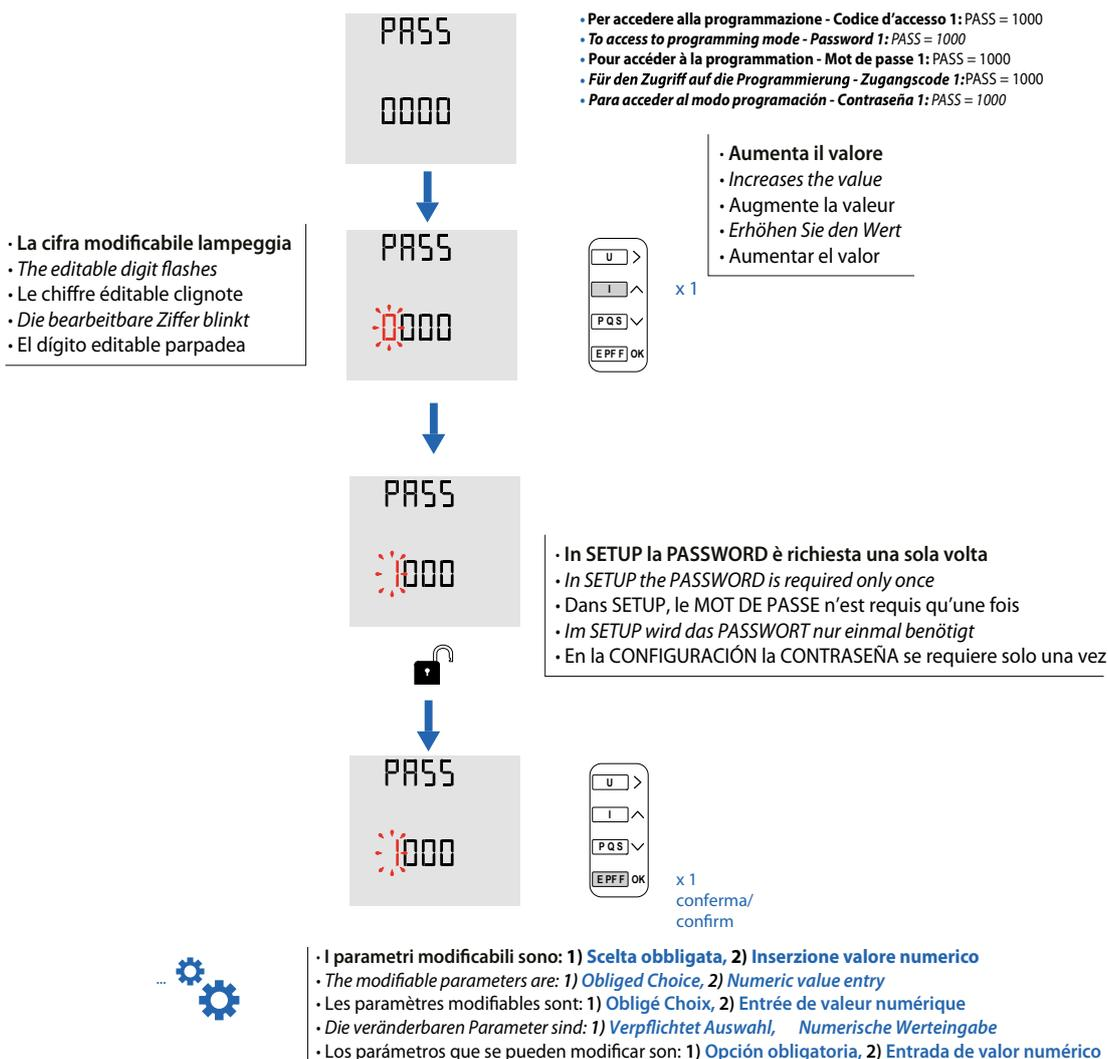

## • Programmazione • Programming • Programmation • Programmierung • Programación

- Come configurare i Parametri Modificabili
- How to configure the Editable Parameters
- Comment configurer les paramètres modifiables
- So konfigurieren Sie Parameter Editierbare
- Cómo configurar los parámetros editables



- 1 • Scelta obbligata**
- Obligated Choice
  - Obligé Choix
  - Verpflichtet Auswahl
  - Opción obligatoria

- Il valore modificabile lampeggia
- The editable digit flashes
- La valeur modifiable clignote
- Der bearbeitbare Wert blinkt
- El valor editable parpadea

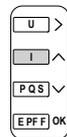

x 1

- Cambia la scelta
- Change the choice
- Changer le choix
- Ändern Sie die Auswahl
- Cambiar la elección

x 1  
confirma  
confirm

- Salva la modifica e sposta al setup successivo
- Save the change and move to the next setup
- Enregistrez la modification et passez à la configuration suivante
- Speichern Sie die Änderung und fahren Sie mit dem nächsten Setup fort
- Guardar el cambio y pase a la siguiente configuración

- 2 • Inserzione valore numerico**
- Numeric value entry
  - Entrée de valeur numérique
  - Numerische Werteingabe
  - Entrada de valor numérico

- La cifra modificabile lampeggia
- The editable digit flashes
- Le chiffre éditabile clignote
- Die bearbeitbare Ziffer blinkt
- El dígito editable parpadea

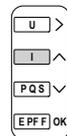

x 1

- Sposta alla cifra modificata successiva
- Move to the next digit modified
- Déplacer vers le chiffre suivant modifié
- Bewegen Sie zur nächsten Stelle geändert
- Mover a la siguiente figura modificada

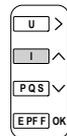

x 1

- Aumenta il valore
- Increases the value
- Augmente la valeur
- Erhöhen Sie den Wert
- Aumentar el valor

x 1  
confirma  
confirm

- Salvare
- Save
- Sauver
- Speichern
- Salvar

**• Nota importante:**

Ad ogni parametro che si vuole modificare, bisogna sempre premere contemporaneamente i tasti x 3 sec.

**• Important note:**

To each parameter you want to modify, always press the x 3 sec keys simultaneously.

**• Note importante:**

Pour chaque paramètre que vous souhaitez modifier, appuyez toujours simultanément sur les touches x 3 sec.

**• Wichtiger Note:**

Zu jedem Parameter, den Sie ändern möchten, drücken Sie immer gleichzeitig die Tasten x 3 Sekunden.

**• Nota importante:**

Para cada parámetro que desea modificar, presione siempre las teclas x 3 segundos simultáneamente.

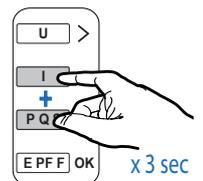

x 3 sec

## • Programmazione • Programming • Programmation • Programmierung • Programación

- Pagina visualizzazione personalizzata
- Customized display page
- Page d'affichage personnalisée
- Kundenspezifische anzeigeseite
- Página de visualización personalizada

- Linea 1- Esempio: Lin1 = V12
- Line 1 - Example: Lin1 = V12
- Ligne 1 - Exemple: Lin1 = V12
- Zeile 1 - Beispiel : Lin1 = V12
- Línea 1 - Ejemplo: Lin1 = V12

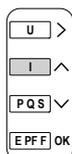

x 1 (V12)    x 6 (ΣVA)  
 x 2 (A1)    x 7 (W1)  
 x 3 (ΣA)    x 8 (VAr1)  
 x 4 (ΣW)    x 9 (VA1)  
 x 5 (ΣVAr) x 10 (ΣPF)

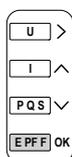

x 1  
 conferma/  
 confirm



- Linea 2- Esempio: Lin2 = V23
- Line 2 - Example: Lin2 = V23
- Ligne 2 - Exemple: Lin2 = V23
- Zeile 2 - Beispiel : Lin2 = V23
- Línea 2 - Ejemplo: Lin2 = V23

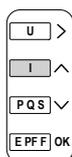

x 1 (V23)    x 6 (W2)  
 x 2 (A2)    x 7 (VAr2)  
 x 3 (ΣW)    x 8 (VA2)  
 x 4 (ΣVAr) x 9 (Hz)  
 x 5 (ΣVA)    x 10 (A1)

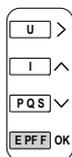
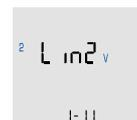

x 1  
 conferma/  
 confirm



- Linea 3- Esempio: Lin3 = V31
- Line 3 - Example: Lin3 = V31
- Ligne 3 - Exemple: Lin3 = V31
- Zeile 3 - Beispiel : Lin3 = V31
- Línea 3 - Ejemplo: Lin3 = V31

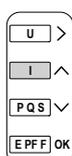

x 1 (V31)    x 6 (W3)  
 x 2 (A3)    x 7 (VAr3)  
 x 3 (ΣW)    x 8 (VA3)  
 x 4 (ΣVAr) x 9 (W1)  
 x 5 (ΣVA)    x 10 (A1)

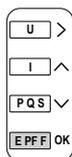

x 1  
 conferma/  
 confirm



• **Nota:**

- La pagina personalizzata, diventerà la visualizzazione standard all'accensione dello strumento

• **Note:**

- The custom page, will become the standard display when the instrument is turned on

• **Note:**

- La page personnalisée, deviendra l'affichage standard à l'allumage du dispositif

• **Note:**

- Die vom Anwender konfigurierte Seite, zeigt sie als Standardanzeigeseite nach dem Einschalten des Geräts an

• **Nota:**

- La página personalizada se convertirá en la vista por defecto cuando el instrumento está encendido

• Programmazione • Programming • Programmation • Programmierung  
• Programación

- **Rete** - Esempio: SyS = 3-3E
- **Network** - Example: SyS = 3-3E
- **Réseau** - Exemple : SyS = 3-3E
- **Netzwerk** - Beispiel: SyS = 3-3E
- **Red** - Ejemplo: SyS = 3-3E

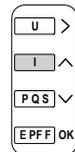

x 1 (3n3E)  
x 2 (3-3E)

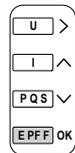

x 1  
conferma/  
confirm

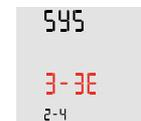

- **Tempo di integrazione delle Correnti e Potenze** - Esempio: tIME = 15 min
- **Integration time of Currents and Powers** - Example: tIME = 15 min
- **Temps d'intégration des Courants et Puissances** - Exemple : tIME = 15 min
- **Integrationszeit für Strommittelwert und Leistungsmittelwert** - Beispiel: tIME = 15 min
- **Tiempo de integración de Corrientes y Potencias** - Ejemplo: tIME = 15 min

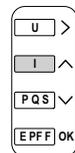

x 1 (8 min)    x 4 (20 min)  
x 2 (10 min)    x 5 (30 min)  
x 3 (15 min)    x 6 (60 min)

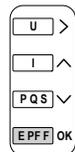

x 1  
conferma/  
confirm



## • Programmazione • Programming • Programmation • Programmierung • Programación

- **Contatore orario**, associato alla soglia percentuale di potenza nominale  
(se la soglia é a 0% il conteggio si avvia con tensione > 20V)
- **Hour run meter**, associated with the nominal power percentage threshold  
(if the threshold is 0% counting starts with voltage > 20V)
- **Compteur horaire**, associé au seuil de pourcentage de la puissance nominale  
(si le seuil est de 0% comptage commence avec une tension > 20V)
- **Stundenzähler**, der dem Schwellenwert für den Nennleistungsprozentsatz zugeordnet ist  
(wenn der Schwellenwert bei 0% liegt, beginnt der Zähler mit einer Spannung > 20 V)
- **Contador horario**, asociado con el umbral de porcentaje de potencia nominal  
(si el umbral está al 0%, el recuento comienza con un voltaje > 20 V)



• Programmazione • Programming • Programmation • Programmierung  
• Programación

- **Indirizzo di comunicazione**  
- Esempio: Addr = 115
- **Communication address**  
- Example: Addr = 115
- **Adresse de communication**  
- Exemple: Addr = 115
- **Kommunikation adresse**  
- Beispiel: Addr = 115
- **Dirección de comunicación**  
- Ejemplo: Addr = 115

MODBUS

MKD4R63DT / MKD4R125DT

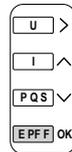
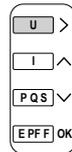
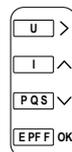
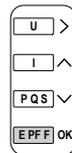
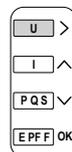
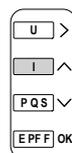
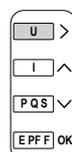
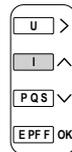
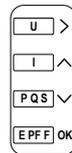

x 1

x 1

x 1

x 1

x 1  
conferma/  
confirm

x 1 (38,40 k)  
x 2 (4,800 k)  
x 3 (9,600 k)

x 1  
conferma/  
confirm



- **Velocità di comunicazione**  
- Esempio: bAUd = 19.2 kbps
- **Communication speed**  
- Example: bAUd = 19.2 kbps
- **Vitesse de communication**  
- Exemple: bAUd = 19.2 kbps
- **Übertragungswindigkeit**  
- Beispiel: bAUd = 19.2 kbps
- **Velocidad de comunicación**  
- Ejemplo bAUd = 19.2 kbps

## • Programmazione • Programming • Programmation • Programmierung • Programación

- **Bit Parità** - Esempio: PAR = odd
- **Parity Bit** - Example: PAR = odd
- **Parité Bit** - Exemple: PAR = odd
- **Paritätsbit** - Beispiel: PAR = odd
- **Bit de Paridad** - Ejemplo: PAR = odd

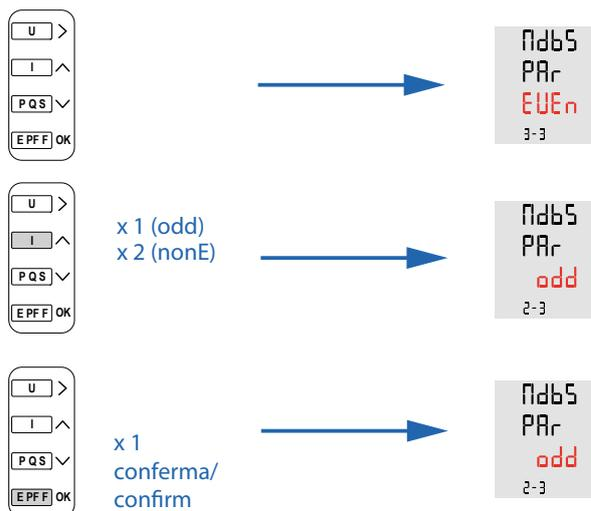

- **Resistenza di terminazione**
- **Termination resistance**
- **Résistance de terminaison**
- **Abschlusswiderstand**
- **Resistencia de terminación**

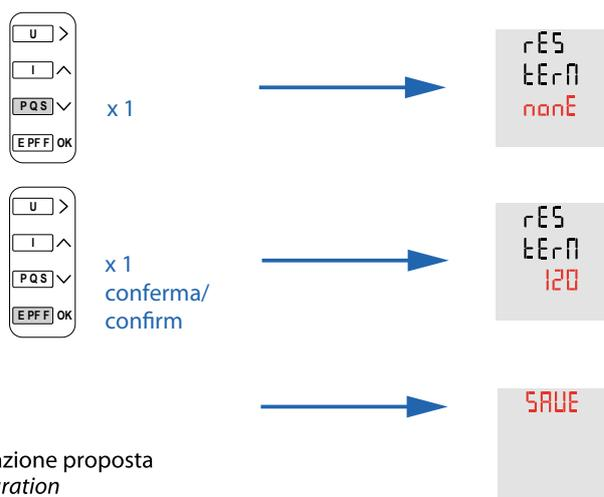

- Salvataggio della configurazione proposta
- *Saving the proposed configuration*
- Sauvegarde de la configuration proposée
- *Speichern der vorgeschlagenen Konfiguration*
- Guardar la configuración propuesta

• Programmazione • Programming • Programmation • Programmierung  
• Programación

- **Indirizzo Primario**  
- Esempio: Addr = 115
- **Primary address**  
- Example: Addr = 115
- **Adresse principale**  
- Exemple: Addr = 115
- **Primäradresse**  
- Beispiel: Addr = 115
- **Dirección principal**  
- Ejemplo: Addr = 115

MBUS

MKD4R63MT / MKD4R125MT

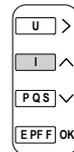
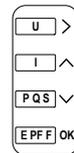

x 1

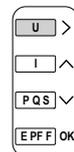

x 1

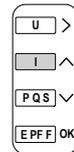

x 1

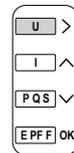

x 1

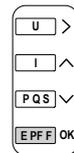

x 1  
conferma/  
confirm



- **Velocità di comunicazione**  
- Esempio: bAUd = 19.2 kbps
- **Communication speed**  
- Example: bAUd = 19.2 kbps
- **Vitesse de communication**  
- Exemple: bAUd = 19.2 kbps
- **Übertragungswindigkeit**  
- Beispiel: bAUd = 19.2 kbps
- **Velocidad de comunicación**  
- Ejemplo bAUd = 19.2 kbps

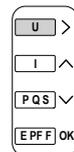
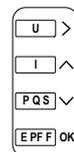

x 1 (4,8k)  
x 2 (9,6k)  
x 3 (19,2k)

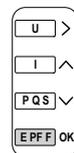

x 1  
conferma/  
confirm



## • Programmazione • Programming • Programmation • Programmierung • Programación

- **Indirizzo Secondario**  
- Esempio: Addr = 100
- **Secondary address**  
- Example: Addr = 100
- **Adresse secondaire**  
- Exemple: Addr = 100
- **Sekundäre Adresse**  
- Beispiel: Addr = 100
- **Dirección Secundaria**  
- Ejemplo: Addr = 100

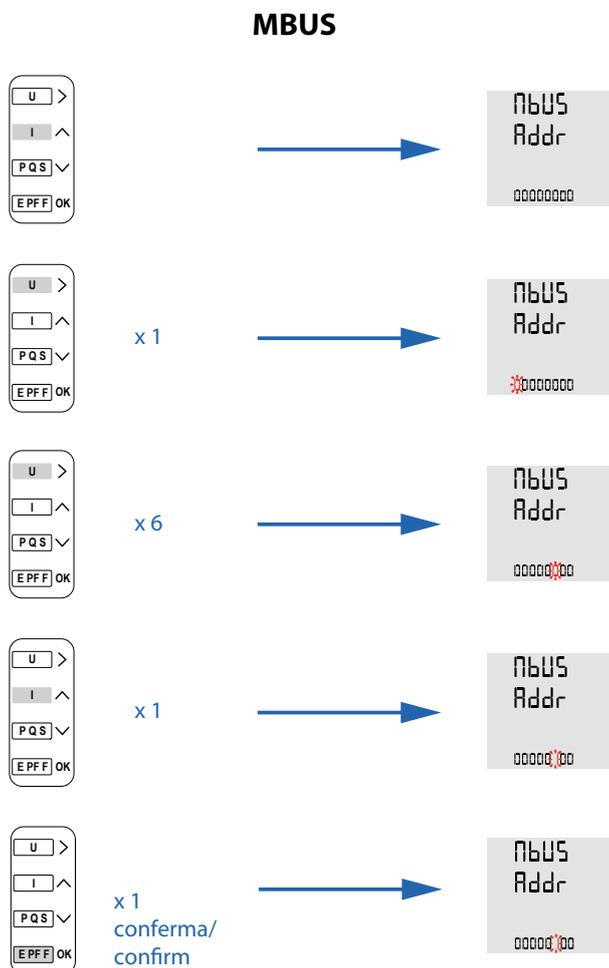

- **Funzione di prova dei collegamenti • Connection test function**
- **Fonction de test du raccordement • Verbindungstestfunktion**
- **Función de prueba de las conexiones**

Per decidere se sia necessario utilizzare la funzione di prova dei collegamenti è sufficiente controllare i segni delle potenze attive di fase che, in situazioni di carico ordinarie, sono positive. Viceversa avviare la procedura di test.

*To decide whether it is necessary to use connection test function is sufficient to check the signs of the phase active powers which, in ordinary load conditions, are positive. Vice versa start the test procedure.*

Pour décider si il est nécessaire d'utiliser la fonction de test des raccordements est suffisante vérifier les signes des puissances actives de phase active qui, dans les situations de charge ordinaires, sont positifs. Si non, lancer la procédure

*Um zu entscheiden, ob die Verbindungstestfunktion verwendet werden muss, ist es ausreichend, die Vorzeichen der Wirkphasenleistungen zu überprüfen, die in normalen Lastsituationen positiv sind. Starten Sie andererseits den Testvorgang.*

Para decidir si es necesario el uso de la función de prueba es suficiente verificar los signos de las potencias activas de fase que, en las condiciones de carga ordinarias, son positivas. Vice versa iniciar el procedimiento de prueba.

- Esempio di errore per una connessione di tipo 3N3E. I valori misurati sono: I1 = 0,850A; I2 = 1,700A; I3 = 1,750A
- Example of error for a connection type 3N3E. The measured values are: I1 = 0,850A; I2 = 1,700A; I3 = 1,750A
- Exemple d'erreur pour une connexion de type 3N3E. Les valeurs mesurées sont les suivantes: I1 = 0,850A; I2 = 1,700A; I3 = 1,750A
- Beispiel für eine Verbindung vom typ 3N3E. Die gemessenen Werte sind: I1 = 0,850A; I2 = 1,700A; I3 = 1,750A
- Ejemplo de error de una conexión de tipo 3N3E. Los valores medidos son: I1 = 0,850A; I2 = 1,700A; I3 = 1,750A

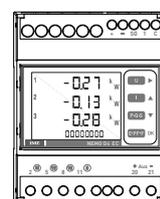
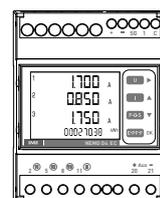
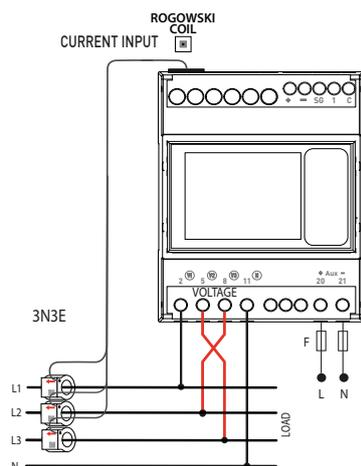

- Correnti I1 e I2 sono scambiate tra di loro
- Tensioni V2 e V3 sono scambiate tra di loro
- Currents I1 and I2 are exchanged between them
- Voltages V2 and V3 are exchanged between them
- Les courants I2 et I1 sont échangés entre eux
- Les tensions V2 et V3 sont échangées entre elles
- Die Ströme I1 und I2 werden zwischen ihnen ausgetauscht
- Die Spannungen V2 und V3 werden zwischen ihnen ausgetauscht
- Las corrientes I2 y I1 se intercambian entre ellos
- Los voltajes V2 y V3 se intercambian entre ellos

- Potenza attiva sulla fase negativa
- Active power on phase is negative
- Puissance active sur la phase négative
- Wirkleistung bei Phase negativ
- Potencia activa en la fase negativa

## • Funzione di prova dei collegamenti • *Connection test function* • Fonction de test du raccordement • *Verbindungstestfunktion* • Función de prueba de las conexiones

Al momento del test, la centrale di misura **MKD4R...** deve avere corrente e tensione su ciascuna fase ed il neutro, se presente, deve essere collegato al terminale corrispondente "N".

**Inoltre, la funzione test richiede:**

- Un sistema Trifase a 120° elettrici.
- Il fattore di potenza deve essere compreso fra 0.9 cap e 0.7 ind per ognuna delle fasi.  
Se il PF dell'impianto non è compreso in questi intervalli, la funzione non può essere utilizzata.

**Prima di iniziare la procedura:**

Misurare le correnti di fase sul lato primario delle sonde Rogowski con una pinza amperometrica ed annotare i valori

**Codici di accesso alle funzioni:**

- 3333 - Avvio della procedura di prova dei collegamenti
- 4444 - Visualizzazione della configurazione attuale
- 5555 - Ripristino della configurazione di fabbrica

*During the test, the **MKD4R...** product must have current and voltage for each of the phases and the neutral, if present, must be connected to the corresponding terminal "N".*

**In addition to this, the function requires:**

- A 120° electrical degrees three-phase system
- The power factor must be between 0.9 cap and 0.7 ind for each phase.  
If the PF of the installation is not within this range, this function cannot be used

**Before starting the procedure:**

Measure the phase currents on the primary side of the Rogowski probes with a current clamp, and annotate the values

**Access codes:**

- 3333 - Starting the connections test procedure
- 4444 - Display of current configuration
- 5555 - Restoring of the factory configuration

Lors du test, le produit **MKD4R...** doit avoir du courant et de la tension sur chacune des phases et le neutre, si est présente, doit être reliée à la borne correspondant "N".

**De plus, cette fonction nécessite:**

- Un système triphasé de 120° électriques.
- Le facteur de puissance doit être compris entre 0.9 cap et 0.7 ind pour chacune des phases.  
Si le PF n'est pas compris dans cette zone, cette fonction ne peut pas être utilisée.

**Avant de commencer le procédé:**

Mesurer les courants de phase sur le côté primaire du sondes de Rogowski avec une pince ampèremétrique et annoter les valeurs

**Codes d'accès aux fonctions:**

- 3333 - Démarrage de la procédure d'essai des connexions
- 4444 - Affichage de la configuration actuelle
- 5555 - Restauration de la configuration d'usine

*Zum Zeitpunkt der Prüfung muss das **MKD4R...**-Messgerät in jeder Phase Strom und Spannung aufweisen. Falls vorhanden, muss der Neutralleiter an die entsprechende Klemme "N" angeschlossen werden.*

**Darüber hinaus erfordert die Testfunktion:**

- Ein 120° elektrisches Dreiphasensystem.
- Der Leistungsfaktor muss für jede Phase zwischen 0,9 kap und 0,7 ind liegen.  
Wenn das Implantat PF nicht in diesen enthalten ist Intervalle kann die Funktion nicht verwendet werden.

**Bevor Sie mit dem Verfahren beginnen:**

Messen Sie die Phasenström auf der Primärseite der Rogowski-Sonden mit einer Stromzange und notieren Sie die Werte

**Zugangscodes für die Funktionen:**

- 3333 - Start des Verbindungstestverfahrens
- 4444 - Anzeige der aktuellen Konfiguration
- 5555 - Werkskonfiguration wiederherstellen

Durante la prueba, el producto **MKD4R...** debe recibir corriente y tensión en cada una de las fases y el neutro, si está presente, debe estar conectado a la terminal correspondiente "N".

**Además de esto, la función requiere:**

- Un sistema trifásico a 120 grados eléctricos
- El factor de potencia ha de estar comprendido entre 0.9 cap y 0.7 ind para cada fase.  
Si el FP de la instalación no está en este intervalo, no se podrá utilizar la función.

**Antes de iniciar el procedimiento:**

Medirlas corrientes de fase en el lado primario de las sondas Rogowski con una pinza de corriente, y anotar los valores.

**Códigos de acceso:**

- 3333 - Inicio del procedimiento de prueba de las conexiones
- 4444 - Visualización de la configuración actual
- 5555 - Restauración de la configuración de fábrica

• **Funzione di prova dei collegamenti • Connection test function**  
 • **Fonction de test du raccordement • Verbindungstestfunktion**  
 • **Función de prueba de las conexiones**

- **Codice per lanciare la funzione di prova • Code to run the test function • Code pour exécuter la fonction de test**
- **Code zum Starten der Testfunktion • Código para ejecutar la función de prueba : PASS = 3333**

- Premere più volte il tasto "EPFF OK" fino a visualizzare la pagina "Protocollo di comunicazione - Tipo di rete - Versione firmware" (vedi esempio):
- Press several times the key "EPFF OK" until you display the "Communication protocol - Network type - Firmware version" page (see example):
- Appuyez plusieurs fois sur la touche « EPFF OK » jusqu'à la page « Protocole de communication - Type de réseau - Version firmware » est affiché (voir l'exemple):
- Drücken Sie mehrmals die Taste "EPFF OK", bis Sie anzeigen Seite "Kommunikationsprotokoll - Netzwerktyp - Firmware-Version" (siehe Beispiel):
- Pulse varias veces la tecla "EPFF OK" hasta que aparezca la página "Protocolo de comunicación - Tipo de red - Versión del firmware" (ver ejemplo):

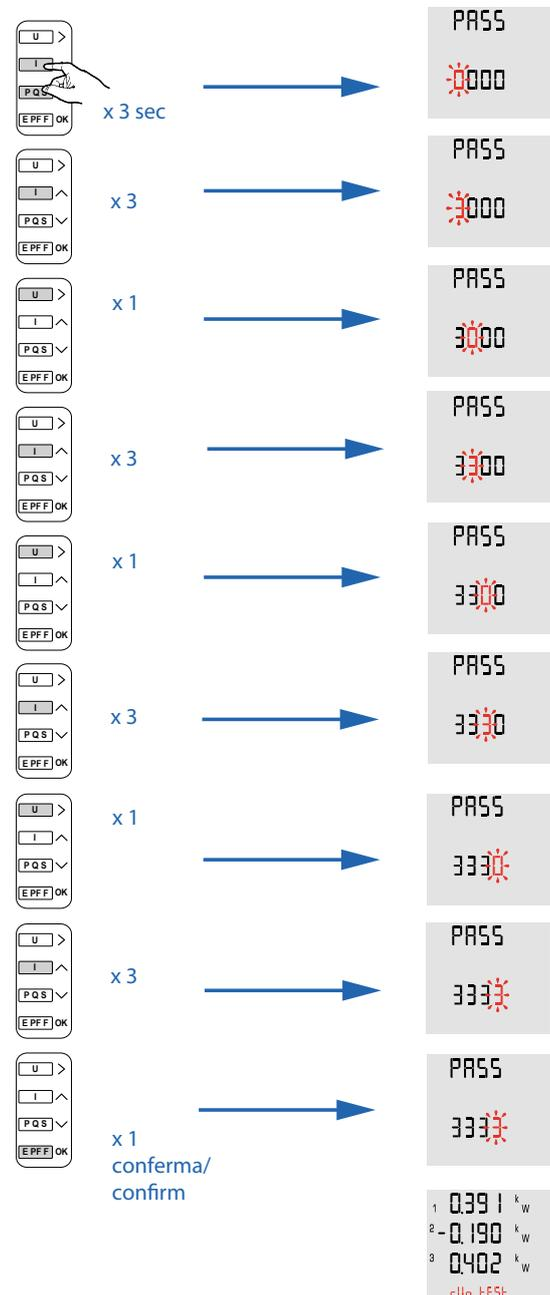

- \* **Nota:**  
- Se non si conosce la password, è necessario attendere 1min. prima che il dispositivo ritorni in visualizzazione
- Note:**  
- If you don't know the password, you need to wait 1min. before that the device returns to display
- Note:**  
- Si vous ne connaissez pas le mot de passe, vous devez attendre 1 min. avant qui revient au dispositif d'affichage
- Note:**  
- Wenn Sie das Passwort nicht kennen, müssen Sie 1 Minute warten. zuerst dass das Gerät zur Anzeige zurückkehrt
- Note:**  
- Si no conoce la contraseña, debe esperar 1 min. primero que vuelva al dispositivo de visualización



## • Funzione di prova dei collegamenti • Connection test function

## • Fonction de test du raccordement • Verbindungstestfunktion

## • Función de prueba de las conexiones

- Completamento della procedura
- Completion of procedure
- Achèvement de la procédure
- Abschluss des Verfahrens
- Finalización del procedimiento

- Spostamento delle correnti nelle posizioni corrette, allineamento della visualizzazione alla misura delle correnti annotata
- Shifting currents in the correct locations, alignment of the current measurement display noted
- Déplacement des courants dans les positions correctes, alignement de l'affichage de mesure actuel noté
- Die Strömungen an die richtigen Positionen bringen, Ausrichtung der aktuellen Messanzeige notiert
- Desplazamiento de las corrientes en las posiciones correcta, alineación de la pantalla de medición actual observada

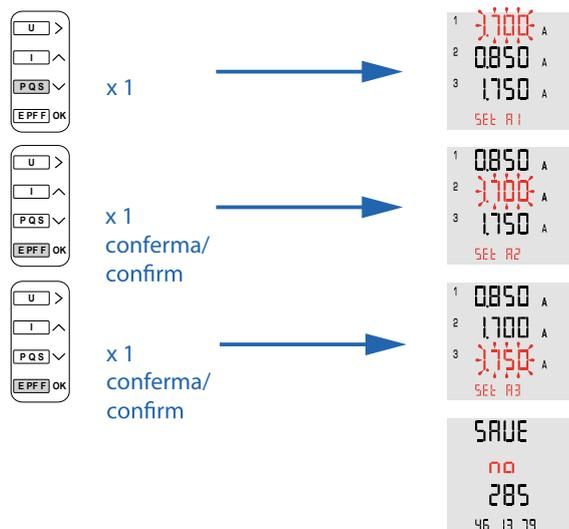

### Interpretazione dell'errore:

Per ottenere le misure corrette, il dispositivo ha eseguito le scelte conseguenti gli errori di cablaggio:

1. Le tensioni di impianto V2 e V3 sono state scambiate tra di loro
  2. Le correnti di impianto I1 e I2 sono state scambiate tra di loro
- Se l'utilizzatore ha scelto "SAVE no" dovrà procedere nel modo seguente:
1. Scambiare le sonde di corrente I1 e I2
  2. Scambiare i cavi ai terminali V3 e V2
  3. Inserire la configurazione di fabbrica (password 5555)
  4. Per sicurezza rilanciare l'autodiagnostica

### Error interpretation:

In order to obtain correct measurements, the device has performed the following choices to correct wiring errors:

1. System voltages V2 and V3 are exchanged between them
2. System currents I1 and I2 are exchanged between them

If the user has chosen "SAVE no" must proceed as follows:

1. To exchange the I1 and I2 current probes
2. To exchange the cables to the terminals V3 and V2
3. Insert the factory configuration (password 5555)
4. For safety relaunch the test procedure

### Interprétation de l'erreur:

Afin d'obtenir des mesures correctes, le dispositif a effectué les choix suivants pour corriger les erreurs de câblage:

1. Les tensions du système V2 et V3 sont échangés entre elles
2. Les courants du système I1 et I2 sont échangés entre eux
3. Le courant I1 a été inversé de 180°:

Si l'utilisateur a choisi "SAVE no", il doit faire ce qui suit:

1. Échangez les sondes I1 et I2 de courant
2. Échangez les câbles aux bornes V3 et V2
3. Insérez la configuration d'usine (mot de passe 5555)
4. Pour la sécurité relancer la procédure de test

### Interpretation des Fehlers:

Um die korrekten Messungen zu erhalten, hat das Gerät nach den Verdrahtungsfehlern die Auswahl getroffen:

1. Die Spannungen V2 und V3 werden zwischen ihnen ausgetauscht
  2. Die Ströme I1 und I2 werden zwischen ihnen ausgetauscht
- Wenn der Benutzer "SAVE no" gewählt hat, muss er wie folgt vorgehen:
1. Tauschen Sie die Stromsonden I1 und I2 aus
  2. Tauschen Sie die Kabel an den V3- und V2-Terminals aus
  3. Geben Sie die Werkskonfiguration ein (Kennwort 5555).
  4. Starten Sie zur Sicherheit die Eigendiagnose erneut

### Interpretación de error:

Para obtener las medidas correctas, el dispositivo ha realizado las siguientes opciones para corregir los errores de cableado:

1. Los voltajes V2 y V3 se intercambian entre ellos
  2. Las corrientes I1 e I2 se intercambian entre ellos
- Si el usuario ha seleccionado "SAVE no", debe proceder de la siguiente manera:

1. Intercambiar las sondas corrientes I1 e I2
2. Intercambiar los cables a los terminales V3 y V2
3. Introduzca la configuración de fábrica (contraseña 5555)
4. Por razones de seguridad relanzar el procedimiento de prueba

- **Funzione di prova dei collegamenti • Connection test function**
- **Fonction de test du raccordement • Verbindungstestfunktion**
- **Función de prueba de las conexiones**

- **Completamento della procedura**
- **Completion of procedure**
- **Achèvement de la procédure**
- **Abschluss des Verfahrens**
- **Finalización del procedimiento**

- Salvataggio della configurazione proposta
- *Saving the proposed configuration*
- Sauvegarde de la configuration proposée
- *Speichern der vorgeschlagenen Konfiguration*
- Guardar la configuración propuesta

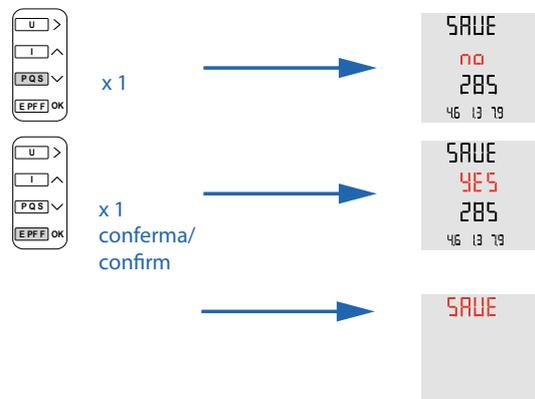

- **Test non riuscito**
- **Test failed**
- **Test échoué**
- **Test fehlgeschlagen**
- **Fallo en la prueba**

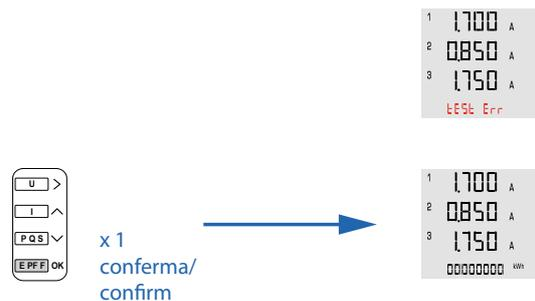

- **Nota:**
  - La procedura termina con errori se non ci sono le condizioni elettriche imposte.  
Cercare manualmente l'errore di cablaggio
- **Note:**
  - *The procedure ends with errors if there aren't the imposed electrical conditions.  
Search manually wiring errors*
- **Note:**
  - La procédure termine avec des erreurs si il n'y a pas les conditions électriques imposées.  
Rechercher manuellement les erreurs de câblage
- **Note:**
  - *Das Verfahren endet fehlerhaft, wenn keine elektrischen Bedingungen auferlegt werden.  
Suchen Sie den Verdrahtungsfehler manuell*
- **Note:**
  - El procedimiento termina con errores si no hay las condiciones eléctricas impuestas.  
Buscar manualmente los errores de cableado

- **Funzione di prova dei collegamenti • Connection test function**
- **Fonction de test du raccordement • Verbindungstestfunktion**
- **Función de prueba de las conexiones**

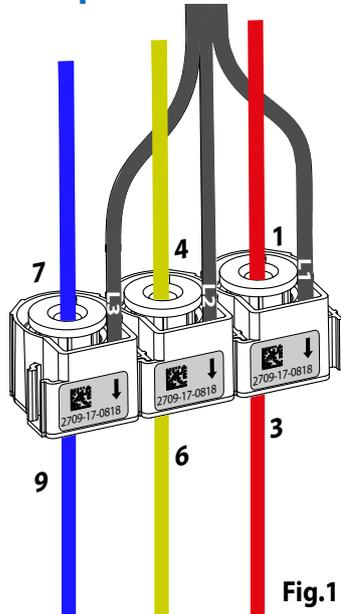

**Fig.1**

La sequenza corretta delle Fasi di Tensione è: **2 5 8** (V1 al morsetto 2); (V2 al morsetto 5); (V3 al morsetto 8) Dopo il lancio della funzione di prova di collegamento viene indicato **2 8 5**, questo indica che la V2 e V3 sono state scambiate tra loro.

La sequenza corretta delle Fasi di Corrente è: **1.3 4.6 7.9** come indicato in Fig.1

Dopo il lancio della funzione di prova di collegamento viene indicato **4.6 1.3 7.9**, questo indica che la I1 e I2 sono state scambiate tra loro.

**Nota:**

**1.3** indica anche il verso corretto della corrente, nel caso venisse indicato **3.1** significherebbe che la corrente I1 ha il verso sbagliato, come indicato in Fig.2

**The correct sequence of the Voltage Phases is: 2 5 8**

(V1 at terminal 2); (V2 at terminal 5); (V3 at terminal 8)

After the launch of the test connection function comes indicated **2 8 5**, this indicates that the V2 and V3 were exchanged between them.

**The correct sequence of the Current Phases is: 1.3 4.6 7.9**, as shown in Fig.1

After the launch of the test connection function comes indicated **4.6 1.3 7.9**, this indicates that I1 and I2 have been exchanged between them.

**Note:**

**1.3** also indicates the correct direction of the current, in the case if **3.1** was indicated it would mean that the current I1 has the wrong direction, as shown in Fig.2

**La séquence correcte des Phases de Tension est: 2 5 8**

(V1 à la borne 2); (V2 au terminal 5); (V3 au terminal 8)

Après le lancement de la fonction de connexion de test, indiqué **2 8 5**, cela indique que les V2 et V3 étaient échangés entre eux.

**La séquence correcte des Phases Actuelles est: 1.3 4.6 7.9**, comme indiqué sur la Fig.1

Après le lancement de la fonction de connexion de test, indiqué **4.6 1.3 7.9**, cela indique que I1 et I2 ont été échangés entre eux.

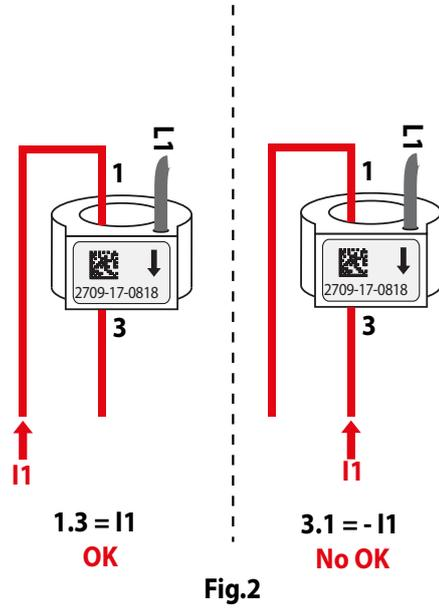

**Fig.2**

**Remarque:**

**1.3** indique également la direction correcte du courant, dans le cas si 3.1 était indiqué, cela signifierait que le courant I1 a le mauvaise direction, comme indiqué sur la Fig.2

**Die korrekte Reihenfolge der Spannungsphasen lautet: 2 5 8**

(V1 an Klemme 2); (V2 an Klemme 5); (V3 an Klemme 8)

Nach dem Start der Testverbindung kommt die Funktion angezeigt **2 8 5**, dies zeigt an, dass die V2 und V3 waren zwischen ihnen ausgetauscht.

**Die korrekte Reihenfolge der aktuellen Phasen lautet:**

**1.3 4.6 7.9**, wie in Fig.1

Nach dem Start der Testverbindung kommt die Funktion angezeigt **4.6 1.3 7.9**, dies zeigt an, dass I1 und I2 gewesen sind zwischen ihnen ausgetauscht.

**Note:**

**1.3** gibt in diesem Fall auch die richtige Richtung des Stroms an Wenn **3.1** angezeigt würde, würde dies bedeuten, dass der Strom I1 die hat falsche Richtung, wie in Fig.2

**La secuencia correcta de las Fases de Voltaje es: 2 5 8**

(V1 en la terminal 2); (V2 en la terminal 5); (V3 en la terminal 8)

Después del lanzamiento de la función de conexión de prueba viene indicado **2 8 5**, esto indica que V2 y V3 fueron intercambiado entre ellos.

**La secuencia correcta de las Fases Corriente es: 1.3 4.6 7.9**, como se muestra en la Fig.1

Después del lanzamiento de la función de conexión de prueba viene indicado **4.6 1.3 7.9**, esto indica que I1 y I2 han sido intercambiado entre ellos.

**Nota:**

**1.3** también indica la dirección correcta de la corriente, en el caso si se indicó **3.1** significaría que el I1 actual tiene el dirección incorrecta, como se muestra en la Fig.2

**• Caratteristiche tecniche**

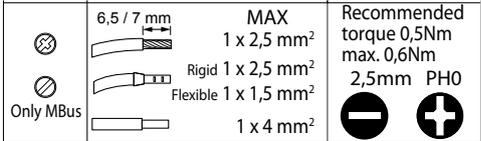
Involucro		
Dimensioni (l x h x p)	71,2 x 90 x 65mm	
Collegamenti		
Grado di protezione:	Frontale IP54, Morsetti IP20	
Peso:	MKD4R63FC001 MKD4R63DT - MKD4R63MT	250 gr.
	MKD4R125FC001 MKD4R125DT - MKD4R125MT	270 gr.
Display		
Tipo:	LCD retroilluminato	
Alimentazione ausiliaria:		
Valore Uaux ca:	230V ± 15%	
Misura		
Rete trifase 3 e 4 fili		
<b>Tensione (TRMS)</b> Misura diretta		
Tensione trifase nominale Un:	3x230V~ / 3x400V~ ± 15%	
Autoconsumo circuito di tensione:	Max. 1,5VA trifase	
Classe di precisione delle tensioni:	0,5	
<b>Corrente (TRMS)</b> Misura diretta	MKD4R63FC001 MKD4R63DT - MKD4R125DT	$I_{min} 0,5A - I_n 10A - I_{max} 63A$
	MKD4R125FC001 MKD4R125DT - MKD4R125MT	$I_{min} 1A - I_n 20A - I_{max} 125A$
Classe di precisione delle correnti:	1	
Sovraccarico di breve durata (IEC/EN 62053-21, IEC/EN 62053-23):	$30 I_{max} / 10ms$	
<b>Frequenza</b>		
Frequenza nominale	$F_n 50Hz; 60Hz$	
Variazione ammessa	45...65Hz	
<b>Energie</b>		
Classe di precisione Energia Attiva:	1 (EN/IEC 62053-21)	
Classe di precisione Energia Reattiva:	2 (EN/IEC 62053-21)	

## • Caratteristiche tecniche

Ingressi digitali	
Tensione:	12-24V DC
Corrente:	Max. 10 mA
Condizioni di utilizzo	
Temperatura di funzionamento:	(-20°C) ÷ (60°C)
Temperatura di immagazzinamento:	(-25°C) ÷ (70°C)
Umidità:	Adatto all'utilizzo in clima tropicale
Massima potenza dissipata:	< 5 W
Ambiente meccanico:	M1
Ambiente elettromagnetico:	E2
Umidità relativa:	95% senza condensa (EN50472-1)
Installazione:	Montaggio del contatore all'interno di un quadro IP51
Utilizzo:	Uso interno

Marcatura CE	
<p>I dispositivi sono conformi:</p> <ul style="list-style-type: none"> <li>• Alle disposizioni della Direttiva Europea sulla compatibilità elettromagnetica (EMC) n° 2014/30/EU</li> <li>• Alla Direttiva bassa tensione n° 2014/35/UE.</li> <li>• Alla Direttiva 2011/65/EU modificata dalla direttiva 2015/863 (RoHS 2).</li> </ul>	
Compatibilità elettromagnetica	
Prove in accordo con IEC/EN 62052-11 - EN 61326-1	
Isolamento (EN 61010-1)	
Categoria di misura:	III
Grado d'inquinamento:	2
Tensione d'isolamento, Ui:	300V Fase-Terra
Tenuta all'impulso:	-Ingressi di misura / Ingressi digitali I/O: onda 1,2 / 50µs 0,5 J: 6kV tensione alternata 50Hz / 1 min.: 3kV -Tutti i circuiti / Massa tensione alternata 50Hz / 1 min.: 4kV
Superficie frontale:	Classe II

## • Caratteristiche tecniche

Conformità alla IEC 61557-12 Edizione 1 (08/2007)			
Caratteristiche del PMD			
Tipo di caratteristica	Valore della caratteristica	Altre caratteristiche complementari	
Funzione di valutazione della Qualità dell'alimentazione	-	-	
Classificazione del PMD	SD / SS	-	
Temperatura	K55	-	
Umidità + Altitudine	Condizioni Standard	-	
Caratteristiche delle funzioni			
Simboli delle funzioni	Classe di prestazione della funzione, secondo la norma IEC 61557-12	Intervallo di misura (Precisione)	Altre caratteristiche complementari
<b>P</b>	1	0,5 ÷ 63 A	
<b>Q<sub>v</sub></b>	2	1 ÷ 63 A	
<b>S<sub>A</sub></b>	1	0,5 ÷ 63 A	
<b>E<sub>a</sub></b>	1 (EN/IEC 62053-21)	0,5 ÷ 63 A	
<b>E<sub>rV</sub></b>	2 (EN/IEC 62053-23)	1 ÷ 63 A	
<b>E<sub>apA</sub>, E<sub>apV</sub></b>	-	-	
<b>f</b>	± 0,1 Hz	45 ÷ 65 Hz	
<b>I</b>	1	0,5 ÷ 63 A	
<b>I<sub>N</sub>, I<sub>NC</sub></b>	3	0,5 ÷ 63 A	
<b>U</b>	0,5	50 ÷ 290 V (Ph/N)	
<b>P<sub>FA</sub>, P<sub>FV</sub></b>	1	0,5 ind ÷ 0,8 cap	
<b>P<sub>st</sub>, P<sub>It</sub></b>	-	-	
<b>U<sub>dip</sub></b>	-	-	
<b>U<sub>swl</sub></b>	-	-	
<b>U<sub>tr</sub></b>	-	-	
<b>U<sub>int</sub></b>	-	-	
<b>U<sub>nba</sub></b>	-	-	
<b>U<sub>nb</sub></b>	-	-	
<b>U<sub>h</sub></b>	-	-	
<b>THD<sub>u</sub></b>	5	> 1,5 %	
<b>THD - R<sub>u</sub></b>	-	-	
<b>I<sub>h</sub></b>	-	-	
<b>THD<sub>i</sub></b>	5	> 3 %	
<b>THD-R<sub>i</sub></b>	-	-	
<b>M<sub>sv</sub></b>	-	-	

## • Technical characteristics

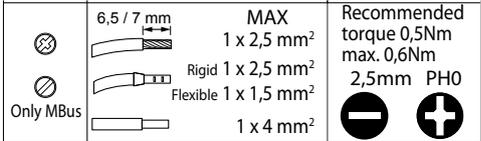
Case		
Dimension (w x h x d)	71,2 x 90 x 65mm	
Connections		
Degree of protection	Front face IP54, Terminals IP20	
Weight:	MKD4R63FC001 MKD4R63DT - MKD4R63MT	250 gr.
	MKD4R125FC001 MKD4R125DT - MKD4R125MT	270 gr.
Display		
Type:	Backlighted LCD display	
Auxiliary supply		
Value $U_{aux\ ac}$ :	230V $\pm$ 15%	
Measurement		
Three-phase 3 and 4-wire network		
<b>Voltage (TRMS)</b> Direct measurement		
Three-phase rated voltage $U_n$ :	3x230V~ / 3x400V~ $\pm$ 15%	
Power consumption voltage circuit:	Max. 1,5VA three-phase	
Voltage accuracy class:	0,5	
<b>Current (TRMS)</b> Direct measurement	MKD4R63FC001 MKD4R63DT - MKD4R125DT	$I_{min}$ 0,5A - $I_n$ 10A - $I_{max}$ 63A
	MKD4R125FC001 MKD4R125DT - MKD4R125DT	$I_{min}$ 1A - $I_n$ 20A - $I_{max}$ 125A
Current accuracy class:	1	
Short-time overcurrent (IEC/EN 62053-21, IEC/EN 62053-23):	$30 I_{max} / 10ms$	
Frequency		
Rated frequency	$F_n$ 50Hz; 60Hz	
Permitted variation	45...65 Hz	
Energies		
Active energy accuracy class:	1 (EN/IEC 62053-21)	
Reactive energy accuracy class:	2 (EN/IEC 62053-23)	

• **Technical characteristics**

<b>Digital inputs</b>	
Voltage:	12-24V DC
Current:	Max. 10 mA
<b>Operating conditions</b>	
Operating temperature:	(-20°C) ÷ (60°C)
Storage temperature:	(-25°C) ÷ (70°C)
Humidity:	Suitable for tropical climates
Max. dissipated power:	< 5 W
Mechanical environment:	M1
Electromagnetic environment:	E2
Relative humidity:	95% not condensing (EN50472-1)
Installation:	Mounting the KWH-meter in a IP51 switchboard
Use:	Indoor

<b>CE Marking</b>	
<p>The devices comply with:</p> <ul style="list-style-type: none"> <li>• The requirements of the European directive on electromagnetic compatibility (EMC) n° 2014/30/EU</li> <li>• The low voltage directive n° 2014/35/UE.</li> <li>• Directive 2011/65/EU modified by directive 2015/863 (RoHS 2).</li> </ul>	
<b>Electromagnetic compatibility</b>	
According to IEC/EN 62052-11 - EN 61326-1	
<b>Insulation (EN 61010-1)</b>	
Measurement category:	III
Degree of pollution:	2
Insulation voltage, Ui:	300V Phase-Earth
Impulse withstand voltage	<ul style="list-style-type: none"> <li>- Measuring inputs / Digital I/O inputs wave 1,2 / 50µs 0,5 J: 6kV alternate voltage 50Hz / 1 min.: 3kV</li> <li>- All circuits / earth alternate voltage 50Hz / 1 min.: 4kV</li> </ul>
Front surface:	Class II

## • Technical characteristics

Conformity IEC 61557-12 Edition 1 (08/2007)			
PMD Characteristics			
Type of characteristic	Specification values	Other complementary characteristics	
Power quality assessment function	-	-	
Classification of PMD	SD / SS	-	
Temperature	K55	-	
Humidity + Altitude	Standard conditions	-	
Characteristics of functions			
Function symbols	Function performance class according to IEC 61557-12	Measuring range (Accuracy)	Other complementary characteristics
<b>P</b>	1	0,5 ÷ 63 A	
<b>Q<sub>V</sub></b>	2	1 ÷ 63 A	
<b>S<sub>A</sub></b>	1	0,5 ÷ 63 A	
<b>E<sub>a</sub></b>	1 (EN/IEC 62053-21)	0,5 ÷ 63 A	
<b>E<sub>RV</sub></b>	2 (EN/IEC 62053-23)	1 ÷ 63 A	
<b>E<sub>apAr</sub>, E<sub>apV</sub></b>	-	-	
<b>f</b>	± 0,1 Hz	45 ÷ 65 Hz	
<b>I</b>	1	0,5 ÷ 63 A	
<b>I<sub>Nr</sub>, I<sub>Nc</sub></b>	3	0,5 ÷ 63 A	
<b>U</b>	0,5	50 ÷ 290 V (Ph/N)	
<b>P<sub>FAr</sub>, P<sub>FV</sub></b>	1	0,5 ind ÷ 0,8 cap	
<b>P<sub>str</sub>, P<sub>It</sub></b>	-	-	
<b>U<sub>dip</sub></b>	-	-	
<b>U<sub>swl</sub></b>	-	-	
<b>U<sub>tr</sub></b>	-	-	
<b>U<sub>int</sub></b>	-	-	
<b>U<sub>nba</sub></b>	-	-	
<b>U<sub>nb</sub></b>	-	-	
<b>U<sub>h</sub></b>	-	-	
<b>THD<sub>u</sub></b>	5	> 1,5 %	
<b>THD - R<sub>u</sub></b>	-	-	
<b>I<sub>h</sub></b>	-	-	
<b>THD<sub>i</sub></b>	5	> 3 %	
<b>THD-R<sub>i</sub></b>	-	-	
<b>Msv</b>	-	-	

## • Caractéristiques techniques

Boîtier		
Dimensions (l x h x p)	71,2 x 90 x 65mm	
Raccordement:		
Indice de protection:	Face avant IP54, Bornes IP20	
Poids:	MKD4R63FC001 MKD4R63DT - MKD4R63MT	250 gr.
	MKD4R125FC001 MKD4R125DT - MKD4R125MT	270 gr.
Afficheur		
Type:	LCD avec rétroéclairage	
Alimentation axiliaire		
Valeur nominale Uaux ca:	230V ± 15%	
Mesure		
Reseau triphasé 3 et 4 fils		
<b>Tension (TRMS)</b> Mesure directe		
Tension triphasée nominale Un:	3x230V~ / 3x400V~ ± 15%	
Autoconsommation circuit de tension:	Max. 1,5VA triphasée	
Classe de précision de tension:	0,5	
<b>Courant (TRMS)</b> Mesure directe	MKD4R63FC001 MKD4R63DT - MKD4R125DT	$I_{min} 0,5A - I_n 10A - I_{max} 63A$
	MKD4R125FC001 MKD4R125DT - MKD4R125DT	$I_{min} 1A - I_n 20A - I_{max} 125A$
Classe de précision de courant:	1	
Surintensité de courte durée (IEC/EN 62053-21, IEC/EN 62053-23):	30 $I_{max}$ / 10ms	
<b>Fréquence</b>		
Fréquence nominale	$F_n$ 50Hz; 60Hz	
Variation admise	45...65 Hz	
<b>Energies</b>		
Classe de précision Energie Active:	1 (EN/IEC 62053-21)	
Classe de précision Energie Réactive:	2 (EN/IEC 62053-23)	

## • Caractéristiques techniques

Entrée numérique	
Tension:	12-24V DC
Courant:	Max. 10 mA
Conditions d' utilisation	
Température de fonctionnement:	(-20°C) ÷ (60°C)
Température de stockage:	(-25°C) ÷ (70°C)
Humidité:	Convient pour les climats tropicaux
Dissipation thermique:	< 5 W
Environnement mécanique:	M1
Environnement électromagnétique:	E2
Humidité relative:	95% sans condensation (EN50472-1)
Installation:	Installation du compteur dans un panneau IP51
Utilisation:	Utilisation interne

Marquage CE	
<p>Le produits répondent aux:</p> <ul style="list-style-type: none"> <li>• Dispositions de la directive européenne sur la compatibilité électromagnétique (CEM) n° 2014/30/UE</li> <li>• A directive basse tension n° 2014/35/EU.</li> <li>• A directive 2011/65/UE modifiée par directive 2015/863 (RoHS 2).</li> </ul>	
Compatibilité électromagnétique	
Essais conformément a IEC/EN 62052-11 - EN 61326-1	
Isolation (EN 61010-1)	
Catégorie de mesure:	III
Degré de pollution:	2
Tension d' isolation, Ui:	300V Phase-Terre
Tension de choc assignée:	- Entrée de mesure / Entrée I/O numérique: onda 1,2 / 50µs 0,5 J: 6kV tension alternatif 50Hz / 1 min.: 3kV -Tous les circuits /Terre: tension alternatif 50Hz / 1 min.: 4kV
Face avant:	Classe II

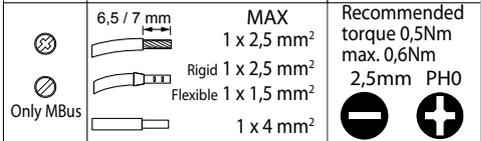

## • Technische Daten

Gehäuse		
Abmessung (L x H x T)	71,2 x 90 x 65mm	
Anschlüsse		
Schutzklasse:	Frontal IP54, Klemmen IP20	
Gewicht:	<b>MKD4R63FC001</b> <b>MKD4R63DT - MKD4R63MT</b>	250 gr.
	<b>MKD4R125FC001</b> <b>MKD4R125DT - MKD4R125MT</b>	270 gr.
Display		
Typ:	LCD mit Hintergrundbeleuchtung	
Hilfsspannung		
Nennwert $U_{aux}$ ca:	230V $\pm$ 15%	
Messung		
Drehstromnetz 3 und 4 Leiter		
<b>Spannung (TRMS)</b> Direkte Messung		
Dreiphasige Nennspannung $U_n$ :	3x230V~ / 3x400V~ $\pm$ 15%	
Selbstverbrauch Spannungskreis	Max. 1,5VA dreiphasig	
Genauigkeitsklasse Spannungs	0,5	
<b>Strom (TRMS)</b> Direkte Messung	<b>MKD4R63FC001</b> <b>MKD4R63DT - MKD4R125DT</b>	$I_{min}$ 0,5A - $I_n$ 10A - $I_{max}$ 63A
	<b>MKD4R125FC001</b> <b>MKD4R125DT - MKD4R125DT</b>	$I_{min}$ 1A - $I_n$ 20A - $I_{max}$ 125A
Genauigkeitsklasse Strom	1	
Kurzzeitige Überlastung (IEC/EN 62053-21, IEC/EN 62053-23):	$30 I_{max} / 10ms$	
Frequenz		
Nennfrequenz	$F_n$ 50Hz; 60Hz	
Spannungsanschlussklemmen	45...65 Hz	
Energie		
Genauigkeitsklasse Wirkenergie:	1 (EN/IEC 62053-21)	
Genauigkeitsklasse Blindenergie:	2 (EN/IEC 62053-23)	

## • Technische Daten

Digitaleingänge	
Spannung:	12-24V DC
Strom:	Max. 10 mA
Gebrauchsbedingungen	
Betriebstemperatur:	(-20°C) ÷ (60°C)
Lagertemperatur:	(-25°C) ÷ (70°C)
Feuchtigkeit:	Geeignet für den Einsatz in tropischem Klima
Maximale Verlustleistung:	< 5 W
Mechanische Umgebung:	M1
Elektromagnetische Umgebung:	E2
Relative Feuchte:	95% ohne Kondensation (EN50472-1)
Installieren:	Montage des Zählers innerhalb eines IP51-Panels
Ausnutzung:	Interne Verwendung

CE-Kennzeichnung	
<p>Die Geräte entsprechen</p> <ul style="list-style-type: none"> <li>• Den Bestimmungen der Europäischen Richtlinie über die elektromagnetische Verträglichkeit (EMV) Nr. 2014/30/EU</li> <li>• Der Niederspannungsrichtlinie 2014/35/EU</li> <li>• Der Richtlinie 2011/65/EG geändert durch Richtlinie 2015/863 (RoHS 2)</li> </ul>	
Elektromagnetische Verträglichkeit	
Prüfungen gemäß IEC/EN 62052-11 - EN 61326-1	
Isolation (EN 61010-1)	
Messkategorie:	III
Verschmutzungsgrad:	2
Isolationsspannung, Ui:	300V Phase-Erde
Impulsdauer:	-Messeingänge / Digitale I / O-Eingänge: Welle 1,2 / 50µs 0,5 J: 6kV Wechselspannung 50Hz / 1 min.: 3kV -Alle Stromkreise / Masse Wechselspannung 50Hz / 1 min.: 4kV
Frontfläche:	Klasse II

## • Technische Daten

Konformität mit IEC 61557-12 Ausgabe 1 (08/2007)			
Eigenschaften des PMD			
Art des Merkmals		Wert des Feature	Andere Funktionen komplementär
Bewertungsfunktion der Qualität der Stromversorgung		-	-
Einstufung der PMD		SD / SS	-
Temperatur		K55	-
Luftfeuchtigkeit + Höhe		Standardbedingungen	-
Merkmale der Funktionen			
Symbole der Funktionen	Funktionsklasse nach IEC 61557-12	Messbereich (Richtigkeit)	Andere Funktionen komplementär
<b>P</b>	1	0,5 ÷ 63 A	
<b>Q<sub>V</sub></b>	2	1 ÷ 63 A	
<b>S<sub>A</sub></b>	1	0,5 ÷ 63 A	
<b>E<sub>a</sub></b>	1 (EN/IEC 62053-21)	0,5 ÷ 63 A	
<b>E<sub>rV</sub></b>	2 (EN/IEC 62053-23)	1 ÷ 63 A	
<b>E<sub>apAr</sub>, E<sub>apV</sub></b>	-	-	
<b>f</b>	± 0,1 Hz	45 ÷ 65 Hz	
<b>I</b>	1	0,5 ÷ 63 A	
<b>I<sub>Nr</sub>, I<sub>Nc</sub></b>	3	0,5 ÷ 63 A	
<b>U</b>	0,5	50 ÷ 290 V (Ph/N)	
<b>P<sub>FAr</sub>, P<sub>FV</sub></b>	1	0,5 ind ÷ 0,8 cap	
<b>P<sub>str</sub>, P<sub>It</sub></b>	-	-	
<b>U<sub>dip</sub></b>	-	-	
<b>U<sub>swl</sub></b>	-	-	
<b>U<sub>tr</sub></b>	-	-	
<b>U<sub>int</sub></b>	-	-	
<b>U<sub>nba</sub></b>	-	-	
<b>U<sub>nb</sub></b>	-	-	
<b>U<sub>h</sub></b>	-	-	
<b>THD<sub>u</sub></b>	5	> 1,5 %	
<b>THD - R<sub>u</sub></b>	-	-	
<b>I<sub>h</sub></b>	-	-	
<b>THD<sub>i</sub></b>	5	> 3 %	
<b>THD-R<sub>i</sub></b>	-	-	
<b>Msv</b>	-	-	

**• Características técnicas**

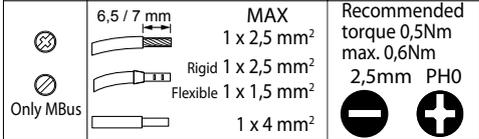
Caja					
Dimensiones (l x h x p)	71,2 x 90 x 65mm				
Conexión					
Indice de protección:	Frente IP54, Terminales IP20				
Peso:	<table border="1" style="width: 100%;"> <tr> <td>MKD4R63FC001 MKD4R63DT - MKD4R63MT</td> <td>250 gr.</td> </tr> <tr> <td>MKD4R125FC001 MKD4R125DT - MKD4R125MT</td> <td>270 gr.</td> </tr> </table>	MKD4R63FC001 MKD4R63DT - MKD4R63MT	250 gr.	MKD4R125FC001 MKD4R125DT - MKD4R125MT	270 gr.
	MKD4R63FC001 MKD4R63DT - MKD4R63MT	250 gr.			
MKD4R125FC001 MKD4R125DT - MKD4R125MT	270 gr.				
Visualizador					
Type:	LCD con retroiluminación				
Alimentación auxiliar					
Valor nominal Uaux ca:	230V ± 15%				
Medidas					
Red trifásica 3 o 4 hilos					
<b>Tensión (TRMS)</b> Medida directa					
Tensión trifásica nominal Un:	3x230V~ / 3x400V~ ± 15%				
Autoconsumo circuito de tensión:	Máx. 1,5VA trifásica				
Clase de precisión de tensión:	0,5				
<b>Corriente (TRMS)</b> Medida directa	<table border="1" style="width: 100%;"> <tr> <td>MKD4R63FC001 MKD4R63DT - MKD4R125DT</td> <td><math>I_{min} 0,5A - I_n 10A - I_{max} 63A</math></td> </tr> <tr> <td>MKD4R125FC001 MKD4R125DT - MKD4R125DT</td> <td><math>I_{min} 1A - I_n 20A - I_{max} 125A</math></td> </tr> </table>	MKD4R63FC001 MKD4R63DT - MKD4R125DT	$I_{min} 0,5A - I_n 10A - I_{max} 63A$	MKD4R125FC001 MKD4R125DT - MKD4R125DT	$I_{min} 1A - I_n 20A - I_{max} 125A$
	MKD4R63FC001 MKD4R63DT - MKD4R125DT	$I_{min} 0,5A - I_n 10A - I_{max} 63A$			
MKD4R125FC001 MKD4R125DT - MKD4R125DT	$I_{min} 1A - I_n 20A - I_{max} 125A$				
Clase de precisión de corriente:	1				
Sobrecorriente de breve duración (IEC/EN 62053-21, IEC/EN 62053-23):	$30 I_{max} / 10ms$				
<b>Frecuencia</b>					
Frecuencia nominal	F <sub>n</sub> 50Hz; 60Hz				
Variación admitida	45...65 Hz				
<b>Energía</b>					
Clase de precisión Energía Activa:	1 (EN/IEC 62053-21)				
Clase de precisión Energía Reactiva :	2 (EN/IEC 62053-23)				

## • Características técnicas

Entradas digitales	
Tensión:	12-24V DC
Corriente:	Máx. 10 mA
Condiciones de uso	
Temperatura de funcionamiento:	(-20°C) ÷ (60°C)
Temperatura de almacenaje:	(-25°C) ÷ (70°C)
Humedad:	Apto para la utilización en un clima tropical
Máxima potencia disipada:	< 5 W
Entorno mecánico:	M1
Entorno electromagnético:	E2
Humedad relativa:	95% sin condensación (EN50472-1)
Instalación:	Montaje del medidor dentro de un panel IP51
Utilización:	Uso en interiores

Marcado CE	
<p>Los dispositivos son conformes:</p> <ul style="list-style-type: none"> <li>• A las disposiciones de la Directiva europea sobre la compatibilidad electromagnética (EMC) n.º 2014/30/EU</li> <li>• A la Directiva baja tensión n.º 2014/35/UE</li> <li>• A la Directiva 2011/65/EU modificada por la directiva 2015/863 (RoHS 2)</li> </ul>	
Compatibilidad electromagnética	
Pruebas en conformidad a IEC/EN 62052-11 - EN 61326-1	
Aislamiento (EN 61010-1)	
Categoría de medida:	III
Grado de polución:	2
Tensión de Aislamiento, Ui:	300V Fase-Tierra
Resistencia al impulso de tensión:	- Entradas de medición / Entradas digitales I/O: onda 1,2 / 50µs 0,5 J: 6kV tensión alterna 50Hz / 1 min.: 3kV -Todos los circuitos / Masa tensión alterna 50Hz / 1 min.: 4kV
Superficie frontal:	Clase II

## • Características técnicas

Conformidad con IEC 61557-12 Edition 1 (08/2007)			
Características del PMD			
Tipo de característica	Valor de la característica	Otras características complementarias	
Funcion de evaluacion de la calidad de la alimentacion	-	-	
Clasificacion de los PMD	SD / SS	-	
Temperatura	K55	-	
Humedad + Altitud	Condiciones estándar	-	
Características de las funciones			
Símbolo de las funciones	Clase de rendimiento de funcionamiento, según la norma IEC 61557-12	Rango de medición (exactitud)	Otras características complementarias
P	1	0,5 ÷ 63 A	
Q <sub>v</sub>	2	1 ÷ 63 A	
S <sub>A</sub>	1	0,5 ÷ 63 A	
E <sub>a</sub>	1 (EN/IEC 62053-21)	0,5 ÷ 63 A	
E <sub>rV</sub>	2 (EN/IEC 62053-23)	1 ÷ 63 A	
E <sub>apA</sub> , E <sub>apV</sub>	-	-	
f	± 0,1 Hz	45 ÷ 65 Hz	
I	1	0,5 ÷ 63 A	
I <sub>N</sub> , I <sub>Nc</sub>	3	0,5 ÷ 63 A	
U	0,5	50 ÷ 290 V (Ph/N)	
P <sub>FA</sub> , P <sub>FV</sub>	1	0,5 ind ÷ 0,8 cap	
P <sub>st</sub> , P <sub>It</sub>	-	-	
U <sub>dip</sub>	-	-	
U <sub>swl</sub>	-	-	
U <sub>tr</sub>	-	-	
U <sub>int</sub>	-	-	
U <sub>nba</sub>	-	-	
U <sub>nb</sub>	-	-	
U <sub>h</sub>	-	-	
THD <sub>u</sub>	5	> 1,5 %	
THD - R <sub>u</sub>	-	-	
I <sub>h</sub>	-	-	
THD <sub>i</sub>	5	> 3 %	
THD-R <sub>i</sub>	-	-	
M <sub>sv</sub>	-	-	

## • Elenco delle abbreviazioni

3n3E	Rete trifase 4 fili, 3 sensori
3-3E	Rete trifase 3 fili, 3 sensori
$\bar{\Sigma}$	Valori medi
$\Lambda$	Massimi valori medi
EACt totP	Energia attiva positiva totale
ErEA totP	Energia reattiva positiva totale
EACt totn	Energia attiva negativa totale
ErEA totn	Energia reattiva negativa totale
Lin 1	Linea 1
Lin 2	Linea 2
Lin 3	Linea 3
MAS	Valore massimo
Min	Valore minimo
PASS	Codice d'accesso
PF	Fattore di potenza
rUn	Avvio del contatore orario associato alla potenza o alla tensione
SyS	Tipo di rete
thd A	THD % delle correnti di fase
thd V	THD % delle tensioni di fase o concatenate
tIME	Tempo di integrazione delle Correnti e Potenze
HZ	Frequenza
tAr1 / tAr2	Tariffa 1 / Tariffa 2
run1 / run2	Lettura in corso
k	kilo (es. / kA = kilo Ampère)
M	Mega (es. / MA = Mega Ampère)
MdbS	Comunicazione Modbus
MbUS	Comunicazione Mbus
Addr	Indirizzo
bAUd	Velocità di comunicazione
PAr	Bit di Parità
rES tErM	Resistenza di terminazione

## • Assistenza

- **Apparecchio spento**  
Verificare l'alimentazione ausiliaria.
- **Tensioni = 0**  
Verificare il collegamento.
- **Correnti = 0 o errate**  
Verificare il collegamento.  
Verificare la configurazione dei ROGOWSKI.
- **Potenze e fattore di potenza ed energie errati**  
Lanciare la funzione di prova del collegamento.
- **Fasi mancanti sullo schermo**  
Verificare la configurazione della rete.

## • Glossary of abbreviations

3n3E	Three-phase 4 wires network, 3 sensors
3-3E	Three-phase 3 wires network, 3 sensors
$\bar{\Sigma}$	Averag values
$\Lambda$	Maximum average values
EACt totP	Total positive active energy
ErEA totP	Total positive reactive energy
EACt totn	Total negative active energy
ErEA totn	Total negative reactive energy
Lin 1	Line 1
Lin 2	Line 2
Lin 3	Line 3
MAS	MAX. value
Min	Min. value
PASS	Password
PF	Power factor
rUn	Hour meter depending on power or voltage
SyS	Network type
thd A	Phase currents THD %
thd V	Phase or chained voltages THD %
tIME	Integration time of Currents and Powers
HZ	Frequency
tAr1 / tAr2	Tariff 1 / Tariff 2
run1 / run2	Reading in progress
k	Kilo (e.g. : kA = kilo amps)
M	Mega (e.g. : MA = mega amps)
ModbuS	Modbus communication
MbUS	Mbus communication
Addr	Address
bAUd	Communication speed
PAr	Parity Bit
rES tErM	Termination resistance

## • Assistance

- **Device switched off**  
Check auxiliary supply.
- **Voltage = 0**  
Verify the connections.
- **Current = 0 or incorrect**  
Verify the connections.  
Verify the configuration of ROGOWSKI's in set up.
- **Powers and power-factor and energies false**  
Use the test connection function.
- **Phases missing on display**  
Check the network configuration (in set up menu).

## • Lexique des abréviations

3n3E	Réseau triphasé 4 fils, 3 capteurs
3-3E	Réseau triphasé 3 fils, 3 capteurs
$\bar{\Sigma}$	Valeurs moyennes
$\Lambda$	Valeurs moyennes maximales
EACt totP	Energie active totale positive
ErEA totP	Energie réactive totale positive
EACt totn	Energie active totale negative
ErEA totn	Energie réactive totale negative
Lin 1	Ligne 1
Lin 2	Ligne 2
Lin 3	Ligne 3
MAS	Valeur maximale
Min	Valeur minimum
PASS	Mot de passe
PF	Facteur de puissance
rUn	Compteur horaire sur la puissance ou sur la tension
SyS	Type de réseau
thd A	THD % des courants de phase
thd V	THD % des tensions de phase ou composées
tIME	Temps d'intégration des Courants et Puissances
HZ	Fréquence
tAr1 / tAr2	Tarif 1 / Tarif 2
run1 / run2	Lecture en cours
k	kilo (ex : kA = kilo ampères)
M	Méga (ex : MA = méga ampères)
Modbus	Communication Modbus
MbUS	Communication Mbus
Addr	Adresse
bAUd	Vitesse de communication
PAr	Parité Bit
rES tErM	Résistance de terminaison

## • Assistance

- **Appareil éteint**  
Vérifiez l'alimentation auxiliaire.
- **Tensions = 0**  
Vérifiez le raccordement.
- **Courants = 0 ou erronés**  
Vérifiez le raccordement.  
Vérifiez la configuration du ROGOWSKI.
- **Puissances et facteurs de puissance et énergies erronés**  
Lancez la fonction de test du raccordement.
- **Phases manquantes sur l'afficheur**  
Vérifiez la configuration du réseau.

## • Abkürzungsliste

3n3E	Dreiphasiges 4-Draht-Netzwerk, 3 Sensoren
3-3E	3-Leiter-Drehstromnetz, 3 Sensoren
$\bar{\Sigma}$	Durchschnittswerte
$\Lambda$	Maximale Durchschnittswerte
EACt totP	Positive Gesamtwirkenergie
ErEA totP	Positive Gesamtblindenergie
EACt totn	Negative Gesamtwirkenergie
ErEA totn	Negative Gesamtblindenergie
Lin 1	Zeile 1
Lin 2	Zeile 2
Lin 3	Zeile 3
MAS	Maximalwert
Min	Minimalwert
PASS	Zugangscode
PF	Leistungsfaktor
rUn	Starten des mit Strom oder Spannung verbundenen Zeitzählers
SyS	Art des Netzwerks
thd A	THD% der Phasenströme
thd V	THD% der Phasen- oder verketteten Spannungen
tIME	Integrationszeitpunkt der Strömungen und Kräfte
HZ	Frequenz
tAr1 / tAr2	Tariff 1 / Tariff 2
run1 / run2	Lesen läuft
k	Kilo (zB / kA = Kilo Ampère)
M	Mega (zB / MA = Mega Ampère)
Mdbus	Kommunikation Modbus
MbUS	Kommunikation Mbus
Addr	Adresse
bAUd	Übertragungsgeschwindigkeit
PAr	Paritätsbit
rES tErM	Ächlusswiderstand

## • Unterstützung

- **Gerät ausgeschaltet**  
Überprüfen Sie die Hilfsenergieversorgung.
- **Spannungen = 0**  
Überprüfen Sie die Verbindung.
- **Ströme = 0 oder falsch**  
Überprüfen Sie die Verbindung.  
Überprüfen Sie die Konfiguration der ROGOWSKI.
- **Falsche Leistungen, Leistungsfaktor und Energien**  
Starten Sie die Verbindungstestfunktion.
- **Stufen fehlen auf dem Bildschirm**  
Überprüfen Sie die Netzwerkkonfiguration.

## • L xico de las abreviaciones

3n3E	Red trif�sica 4 hilos, 3 sensores
3-3E	Red trif�sica 3 hilos, 3 sensores
$\bar{\Sigma}$	Valores medios
$\Lambda$	Valores medios m�ximos
EACt totP	Energ�a activa positiva
ErEA totP	Energ�a reactiva positiva
EACt totn	Energ�a activa negativa
ErEA totn	Energ�a reactiva negativa
Lin 1	L�nea 1
Lin 2	L�nea 2
Lin 3	L�nea 3
MAS	Valor m�ximo
Min	Valor m�nimo
PASS	Contrase�a
PF	Factor de potencia
rUn	Contador horario configurado sobre la potencia o la tensi�n
SyS	Tipo de red
thd A	THD % de las corrientes de fase
thd V	THD % de las tensiones de fase ou compuestas
tIME	Tiempo de integraci�n de las Intensidades y Potencias
HZ	Frecuencia
tAr1 / tAr2	Tarifario 1 / Tarifario 2
run1 / run2	Lectura en progreso
k	kilo (por ejemplo, / kA = kilo amperio)
M	Mega (por ejemplo, / MA = Mega Amperio)
Mdbus	Comunicaci�n Modbus
MbUS	Comunicaci�n Mbus
Addr	Direcci�n
bAUd	Velocidad de comunicaci�n
PAr	Bit de Paridad
rES tErM	Resistencia de terminaci�n

## • Assistance

- **Appareil  teint**  
V rifiez l'alimentation auxiliaire.
- **Tensions = 0**  
V rifiez le raccordement.
- **Courants = 0 ou erron s**  
V rifiez le raccordement.  
V rifiez la configuration du ROGOWSKI.
- **Puissances et facteurs de puissance et  nergies erron s**  
Lancez la fonction de test du raccordement.
- **Phases manquantes sur l'afficheur**  
V rifiez la configuration du r seau.



A Group brand |  **legrand**

BTicino S.p.A  
Viale Borri, 231  
21100 Varese (VA) ITALY  
[www.imeitaly.com](http://www.imeitaly.com)



BTicino si riserva in qualsiasi momento il diritto di modificare i contenuti di questo opuscolo e di comunicare, in qualsiasi forma e modalità, i cambiamenti apportati allo stesso.  
BTicino reserves at any time the right to modify the contents of this booklet and to communicate, in any form and modality, the changes brought to the same.