

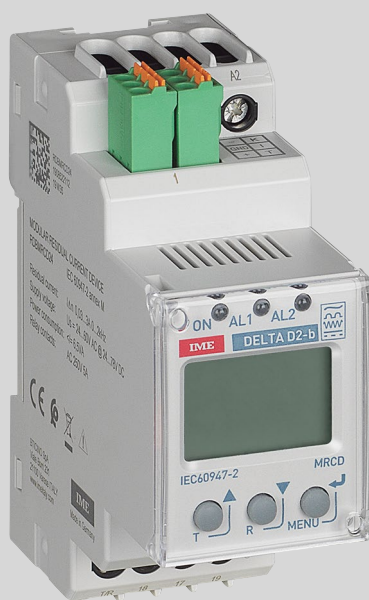

A Group brand | legrand

# Relè differenziale MRCD di tipo "B" Type "B" MRCD differential relay

Manuale d'installazione • *Installation manual* • Manuel d'installation  
• *Installationsanweisungen* • Manual de instalación





## Sommario

Pericoli e avvertenze	4
Operazioni preliminari	5
Presentazione	6
Installazione	7
Utilizzo	13
Programmazione	14
Diagnostica	20
Caratteristiche tecniche	21
Elenco delle abbreviazioni	22

## Contents

<i>Dangers and warnings</i>	4
<i>Preliminary operations</i>	5
<i>Presentation</i>	6
<i>Installation</i>	7
<i>Use</i>	13
<i>Programming</i>	14
<i>Diagnosis</i>	20
<i>Technical characteristics</i>	23
<i>Glossary of abbreviations</i>	24

## Sommaire

Danger et avertissement	4
Opérations préalables	5
Présentation	6
Installation	7
Utilisation	13
Programmation	14
Surveillance	20
Caractéristiques techniques	25
Lexique des abréviations	26

## Summary

<i>Gefahren und Warnungen</i>	4
<i>Vorarbeiten</i>	5
<i>Presentation</i>	6
<i>Installieren</i>	7
<i>Verwendung</i>	13
<i>Programmierung</i>	14
<i>Überwachung</i>	20
<i>Technische Daten</i>	27
<i>Abkürzungsliste</i>	28

## Índice

Advertencia	5
Operaciones previas	5
Presentación	7
Instalación	7
Utilización	13
Programación	14
Vigilancia	20
Características técnicas	29
Lèxico de las abreviaciones	30

## • Pericoli e avvertenze

Questi apparecchi devono essere montati esclusivamente da professionisti.  
Il mancato rispetto delle indicazioni contenute nelle presenti istruzioni solleva il fabbricante da ogni responsabilità.

### **Rischi di folgorazione, ustioni o esplosione**

- L'installazione e la manutenzione di questo apparecchio devono essere effettuate esclusivamente da personale qualificato.
  - Prima di qualsiasi intervento sull'apparecchio, escludere gli ingressi di tensione.
  - Utilizzare sempre un opportuno dispositivo di rilevamento di tensione per confermare l'assenza di tensione.
  - Rimontare tutti i dispositivi, i portelli e i coperchi prima di mettere l'apparecchio sotto tensione.
  - Per alimentare questo apparecchio, utilizzare sempre la tensione nominale indicata.
- In caso di mancato rispetto di queste precauzioni, si potrebbero subire gravi ferite.

### **Rischi di deterioramento dell'apparecchio**

Attenzione a rispettare:

- Una tensione ai morsetti degli ingressi di tensione (A1-A2) secondo i valori indicati nella sezione "Caratteristiche tecniche".

## • Dangers and warnings

*This equipment must only be mounted by professionals.*

*The manufacturer shall not be held responsible for failure to comply with the instructions in this manual.*

### **Risk of electrocution, burns or explosion**

- *The device must only be installed and serviced by qualified personnel.*
  - *Prior to any work on or in the device, isolate the voltage inputs.*
  - *Always use an appropriate voltage detection device to confirm the absence of voltage.*
  - *Put all mechanisms, door and covers back in place before energising the device.*
  - *Always supply the device with the indicated rated voltage.*
- Failure to take these precautions could cause serious injuries.*

### **Risk of damaging the device**

*Chek the following:*

- *The voltage to the voltage-input terminals, (A1-A2) according to the values indicated in the "Technical characteristics" section.*

## • Danger et avertissement

Le montage de ce produit ne peut être effectué que par des professionnels.

Le non respect des indications de la présente notice ne saurait engager la responsabilité du constructeur.

### **Risque d'électrocution, de brûlures ou d'explosion**

- L'installation et l'entretien de cet appareil ne doivent être effectués que par du personnel qualifié.
  - Avant toute intervention sur l'appareil, coupez les entrées tensions.
  - Utilisez toujours un dispositif de détection de tension approprié pour confirmer l'absence de tension.
  - Remplacez tous les dispositifs, les portes et les couvercles avant de mettre cet appareil sous tension.
  - Utilisez toujours la tension assignée appropriée pour alimenter cet appareil.
- Si ces précautions n'étaient pas respectées, cela pourrait entraîner des blessures graves.

### **Risque de détérioration de l'appareil**

Veillez à respecter

- Une tension aux bornes des entrées tensions (A1-A2) selon les valeurs indiquées dans la section "Caractéristiques techniques".

## • Gefahren und Warnungen

*Diese Geräte dürfen nur von Fachleuten montiert werden.*

*Die Nichtbeachtung der vorliegenden Anweisungen entbindet den Hersteller von jeglicher Haftung.*

### **Stromschlag-, Verbrennungs- und Explosionsgefahr**

- *Die Installation und Wartung dürfen nur von qualifizierten Fachleuten vorgenommen werden.*
  - *Vor jedem Eingriff in das Gerät sind die Spannungseingänge auszuschließen.*
  - *Verwenden Sie immer ein geeignetes Spannungsmessgerät, um die Spannungsfreiheit zu überprüfen.*
  - *Alle Geräte, Türen und Abdeckungen wieder montieren, bevor Sie das Gerät unter Spannung setzen.*
  - *Verwenden Sie immer die angegebene Nennspannung, um das Gerät mit Strom zu versorgen.*
- Die Nichtbeachtung dieser Vorsichtsmaßnahmen kann zu schweren Verletzungen führen.*

### **Beschädigungsgefahr des Gerätes**

*Bitte beachten:*

- *Eine Spannung an den Klemmen der Spannungseingänge (A1-A2) entsprechend den im Kapitel "Technische Daten" angegebenen Werten*

## • Advertencia

El montaje de estos materiales sólo puede ser efectuado por profesionales.  
No respetar las indicaciones del presente manual exime de responsabilidad al fabricante.

### Riesgo de electrocución, de quemaduras o de explosión

- La instalación y mantenimiento de este aparato debe ser efectuado por personal cualificado.
- Antes de cualquier intervención en el aparato, cortar sus entradas de tensión.
- Utilizar siempre un dispositivo de detección de tensión apropiado para asegurar la ausencia de tensión.
- Volver a colocar todos los dispositivos, tapas y puertas antes de dar tensión al aparato en tensión.
- Utilizar siempre la tensión asignada apropiada para alimentar el aparato.

No respetar estas precauciones podría entrañar un serio riesgo de producir heridas graves.

### Riesgo de deterioros de aparato

Se ha de respetar:

- Una tensión en los bornes de las entradas de tensión (A1-A2) según los valores indicados en la sección "Características técnicas".

## • Operazioni preliminari

Per la sicurezza del personale e del materiale, è indispensabile leggere attentamente il contenuto del presente libretto prima della messa in servizio.

Al momento del ricevimento della scatola contenente il dispositivo, è necessario verificare i seguenti punti:

- lo stato dell'imballo;
- l'assenza di danneggiamenti o rotture dovuti al trasporto;
- la rispondenza tra codice dell'apparecchio e codice ordinato;
- la presenza nell'imballo sia dell'articolo che del foglio istruzioni.

## • Preliminary operations

*For personnel and product safety read the contents of these operating instructions carefully before connecting.*

*Check the following points as soon as you receive the box containing the device:*

- *the packing is in good condition;*
- *the product has not been damaged or broken during transport;*
- *the product reference number conforms to your order;*
- *the package contains both the item and the operating instructions.*

## • Opérations préalables

Pour la sécurité du personnel et du matériel, il est impératif de bien s'imprégner du contenu de cette notice avant la mise en service.

Au moment de la réception du colis contenant le produit, il est nécessaire de vérifier les points suivants :

- l'état de l'emballage ;
- le produit n'a pas eu de dommage pendant le transport ;
- la référence de l'appareil est conforme à votre commande
- l'emballage comprend le produit ;
- une notice d'utilisation.

## • Vorarbeiten

*Für die Sicherheit von Personen und Material ist es unerlässlich, den Inhalt dieser Anleitung vor der Inbetriebnahme aufmerksam zu lesen. Nach Erhalt der Schachtel mit dem Gerät sind die folgenden Punkte zu überprüfen:*

- *Zustand der Verpackung;*
- *Das Fehlen von Beschädigungen oder Bruch durch den Transport;*
- *die Übereinstimmung zwischen Gerätecode und bestelltem Code;*
- *Vorhandensein in der Verpackung sowohl des Artikels als auch der Gebrauchsanweisung.*

## • Operaciones previas

Para la seguridad del personal y del material, será imperativo conocer perfectamente el contenido de este manual antes de su puesta en funcionamiento.

Al recibir el paquete que contiene el producto será necesario verificar los aspectos siguientes:

- estado del embalaje;
- que el producto no se haya dañado durante el transporte;
- que la referencia del aparato esté conforme con su pedido;
- el embalaje incluye el producto;
- el manual de utilización.

## • Presentazione

Il relè differenziale di tipo B è utilizzato per la protezione di impianti dove sono presenti circuiti non lineari in grado di generare corrente di guasto a terra con componenti continue e/o ad alta frequenza.

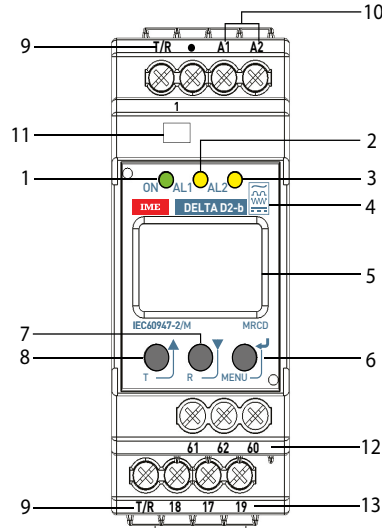

### Segnalazione visiva

1. LED ON "Verde" presenza tensione ausiliaria
2. LED AL1 "Giallo" preallarme IΔn 1
3. LED AL2 "Giallo" allarme TRIP, sgancio bobina IΔn 2
4. Simbologia "Differenziale di tipo B"
5. Display LCD, 1000 punti 3 cifre

### Tastiera composta da 3 pulsanti a doppia funzionalità

6. ENTER (conferma dati in programmazione)  
MENU (premendo >2s si entra in programmazione)
7. Decremento di un valore in programmazione  
RESET (ripristino manuale)
8. Incremento di un valore in programmazione  
TEST (manuale)

### Morsetti d'ingresso

9. Pulsante esterno combinato test e reset "T / R":  
- pressione breve (<1,5 s) = RESET  
- pressione prolungata (> 1,5 s) = TEST
10. Tensione ausiliaria A1-A2
11. Ingresso segnale dal toroide TDB...

### Morsetti d'uscita

12. Relè preallarme 61-62-60 (programmabile n.c/n.o)
13. Relè TRIP 18-17-19 (programmabile n.c/n.o)

## • Presentation

The type B differential relay is used for protecting systems including non linear circuits capable of generating earth fault currents with continuous and/or high frequency components.

### Visual notification

1. LED ON "Green" presence of auxiliary voltage
2. LED AL1 "Yellow" pre-alarm IΔn 1
3. LED AL2 "Yellow" TRIP alarm, coil release IΔn 2
4. Symbols of "Type B Differential"
5. LCD display, 1000 points 3 digits

### Keypad made up of 3 double-function pushbuttons

6. ENTER (confirm programming data)  
MENU (access the programming mode by pressing >2s)
7. Decrease of a programming value RESET (manual reset)
8. Increase of a programming value TEST (manual)

### Input terminals

9. "T / R" combined external test and reset button:  
- short press (<1.5 s) = RESET  
- prolonged pressure (> 1.5 s) = TEST
10. A1-A2 auxiliary voltage
11. Signal input from TDB toroid...

### Output terminals

12. Pre-alarm relay 61-62-60 (n.c/n.o programmabile)
13. TRIP relay 18-17-19 (n.c/n.o programmabile)

## • Présentation

Le relai différentiel de type « B » est utilisé pour la protection d'installations qui présentent des circuits non linéaires en mesure de générer un courant de panne à la terre avec des composants continus et/ou à haute fréquence.

### Signal visuel

1. Voyant ON « vert » : présence tension auxiliaire
2. Voyant AL1 « jaune » : pré-alarme IΔn 1
3. Voyant AL2 « jaune » : allarme TRIP, décrochage bobine IΔn 2
4. Symbole différentiel de type B
5. Écran LCD, 1000 points, 3 chiffres

### Clavier constitué de 3 boutons à deux fonctions

6. ENTER (confirmation données en programmation)  
MENU (appuyer plus de 2 secondes pour accéder à la programmation)
7. Diminution d'une valeur en programmation RESET (reset manuel)
8. Augmentation d'une valeur en programmation TEST (manuel)

### Bornes d'entrée

9. Bouton de test externe et de réinitialisation combiné "T / R":  
- appui court (<1,5 s) = RESET  
- pression prolongée (> 1,5 s) = TEST
10. Tension auxiliaire A1-A2
11. Entrée signal provenant du toroïde TDB...

### Bornes de sortie

12. Relai pré-alarme 61-62-60 (programmable n.c/n.o)
13. Relai TRIP 18-17-19 (programmable n.c/n.o)

## • Presentation

Das Differenzrelais Typ B wird für den Schutz von Anlagen eingesetzt, in denen nichtlineare Stromkreise vorhanden sind, die in der Lage sind, Erdschlussstrom mit kontinuierlichen und/oder hochfrequenten Komponenten zu erzeugen.

### Visuelle Signalisierung

1. LED ON „grün“ Hilfsspannung vorhanden
2. LED AL1 „gelb“ Voralarm IΔn 1
3. LED AL2 „gelb“ Alarm TRIP Spule ausgelöst IΔn 2
4. Symbol „Differentialstrom Typ B"
5. LCD-Anzeige, 1000 Punkte 3 Ziffern

### Tastatur bestehend aus 3 Tasten mit Doppelfunktion

6. ENTER (Programmierdaten bestätigen)  
MENÜ (durch 2 s langes Drücken, wird die Programmierung abgerufen)
7. Abnahme eines programmierten Werts RESET (manuell zurücksetzen)
8. Zunahme eines programmierten Werts TEST (manuell)

### Eingangsklemmen

9. Kombinierte externe Test- und Reset-Taste "T / R":  
- kurz drücken (<1,5 s) = RESET  
- längerer Druck (> 1,5 s) = TEST
10. Hilfsspannung A1-A2
11. Signaleingang des Ringstromwandlers TDB...

### Ausgangsanschlüsse

12. Relais Voralarm 61-62-60 (programmierbar n.c./n.o.)
13. Relais TRIP 18-17-19 (programmierbar n.c./n.o.)

# Relè differenziale MRCD di tipo "B"

## Type "B" MRCD differential relay

### • Presentación

El relé diferencial de tipo B se utiliza para proteger sistemas donde existen circuitos no lineales, que generan una corriente de falta a tierra con componentes continuos y/o de alta frecuencia.

#### Señal visual

1. LED ON "Verde" presencia de tensión auxiliar
2. LED AL1 "Amarillo" prealarma  $I\Delta n$  1
3. LED AL2 "Amarillo" alarma TRIP, desenganche bobina  $I\Delta n$  2
4. Símbolos "Diferencial de tipo B"
5. Pantalla LCD, 1000 puntos 3 cifras

#### Teclado compuesto por 3 botones con doble función

6. ENTER (confirmación datos en programación)  
MENU (al pulsar >2s se entra en programación)
7. Decremento de un valor en programación RESET (restablecimiento manual)
8. Incremento de un valor en programación TEST (manual)

#### Bornes de entrada

9. Prueba externa combinada "T / R" y botón de reinicio:
  - pulsación breve (<1.5 s) = RESET
  - presión prolongada (> 1.5 s) = PRUEBA
10. Tensión auxiliar A1-A2
11. Entrada señal del toroide TDB...

#### Terminales de salida

12. Relé prealarma 61-62-60 (programable n.c/n.o)
13. Relé TRIP 18-17-19 (programable n.c/n.o)

#### • Posizioni per la piombatura

- Positions for lead plating
- Positions pour le plombage
- Positionen der Plombierung
- Posiciones por el Emplomado

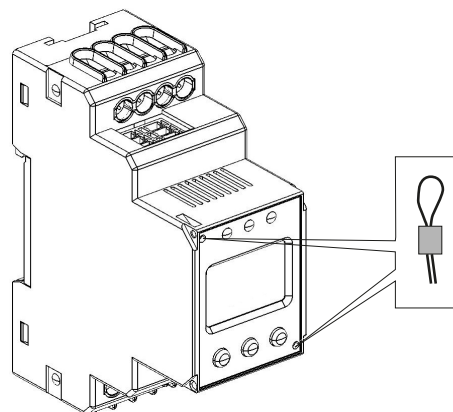

## • Installazione • Installation • Installation • Installieren • Instalación

#### • Prescrizioni

- Evitare la vicinanza con sistemi generatori di perturbazioni elettromagnetiche.

#### • Recommendations

- Avoid proximity to systems which generate electromagnetic interference.

#### • Recommendations

- Éviter la proximité avec des systèmes générateurs de perturbations électromagnétiques

#### • Rezepte

- Nähe zu Generatorsystemen vermeiden elektromagnetische Störungen.

#### • Prescripciones

- Evitar la proximidad con sistemas que generan interferencias electromagnéticas.

**• Installazione • Installation • Installation • Installieren • Instalación**

**Il range di settaggio di IΔn sul toroide (TDB...) deve essere congruo con la soglia di sgancio programmata nel MRCD**

*The setup range of IΔn on the toroid (TDB...) must be consistent with the release threshold set in MRCD*

*La plage de réglage de IΔn sur le toroïde (TDB...) doit être cohérente avec le seuil de décrochage programmé dans le MRCD*

*Der Einstellbereich von IΔn am Ringstromwandler (TDB...) muss mit dem im MRCD programmierten Freigabeschwellenwert übereinstimmen*

*El rango de configuración de IΔn en el toroide (TDB...) ha de ser coherente con el umbral de desenganche programado en el MRCD*

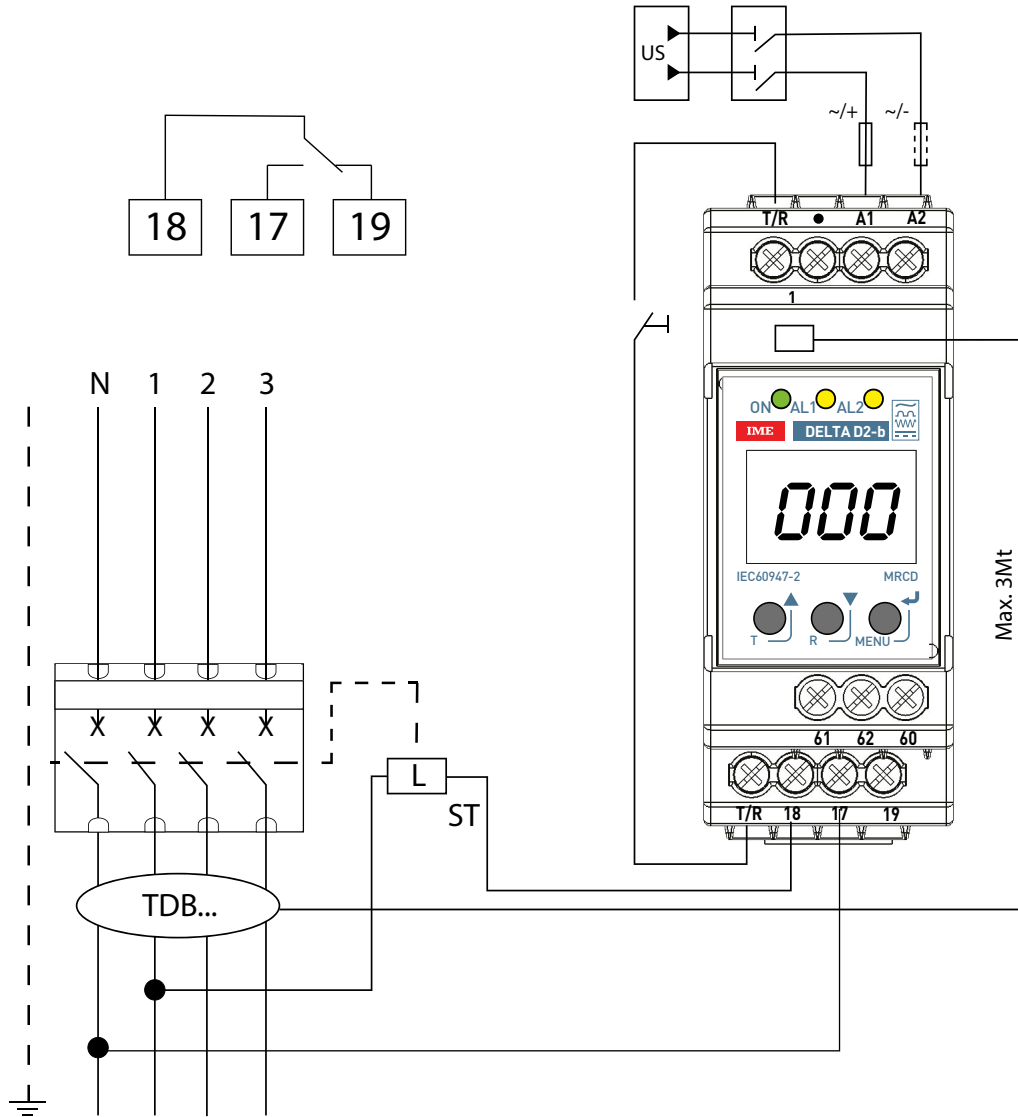

**Sicurezza positiva** contatto normalmente chiuso con strumento alimentato

**N.C.** apertura automatica in caso di mancanza tensione di alimentazione (Us quando separata dalla linea da proteggere)

**Positive safety** normally closed contact with powered instrument

**N.C.** automatic opening in case of lack of supply voltage (Us when separated from the line to be protected)

**Sécurité positive** contact normalement fermé avec instrument alimenté

**N.C.** ouverture automatique en cas de manque tension d'alimentation (Us en cas de séparation de la ligne à protéger)

**Positive Sicherheit** normalerweise geschlossener Kontakt mit angetriebenem Instrument

**N.C.** automatisches Öffnen von Spannungsmangel Energieversorgung (Us bei Trennung von der zu schützenden Leitung)

**Seguridad positiva** contacto normalmente cerrado con el instrumento conectado

**N.C.** apertura automática en caso de falta voltaje de alimentación (Us cuando se separa de la línea a ser protegido)



• **Installazione** • *Installation* • *Installation* • *Installieren* • *Instalación*

Il range di settaggio di  $I\Delta n$  sul toroide (TDB...) deve essere congruo con la soglia di sgancio programmata nel MRCD

*The setup range of  $I\Delta n$  on the toroid (TDB...) must be consistent with the release threshold set in MRCD*

La plage de réglage de  $I\Delta n$  sur le toroïde (TDB...) doit être cohérente avec le seuil de décrochage programmé dans le MRCD

*Der Einstellbereich von  $I\Delta n$  am Ringstromwandler (TDB...) muss mit dem im MRCD programmierten Freigabeschwellenwert übereinstimmen*

El rango de configuración de  $I\Delta n$  en el toroide (TDB...) ha de ser coherente con el umbral de desenganche programado en el MRCD

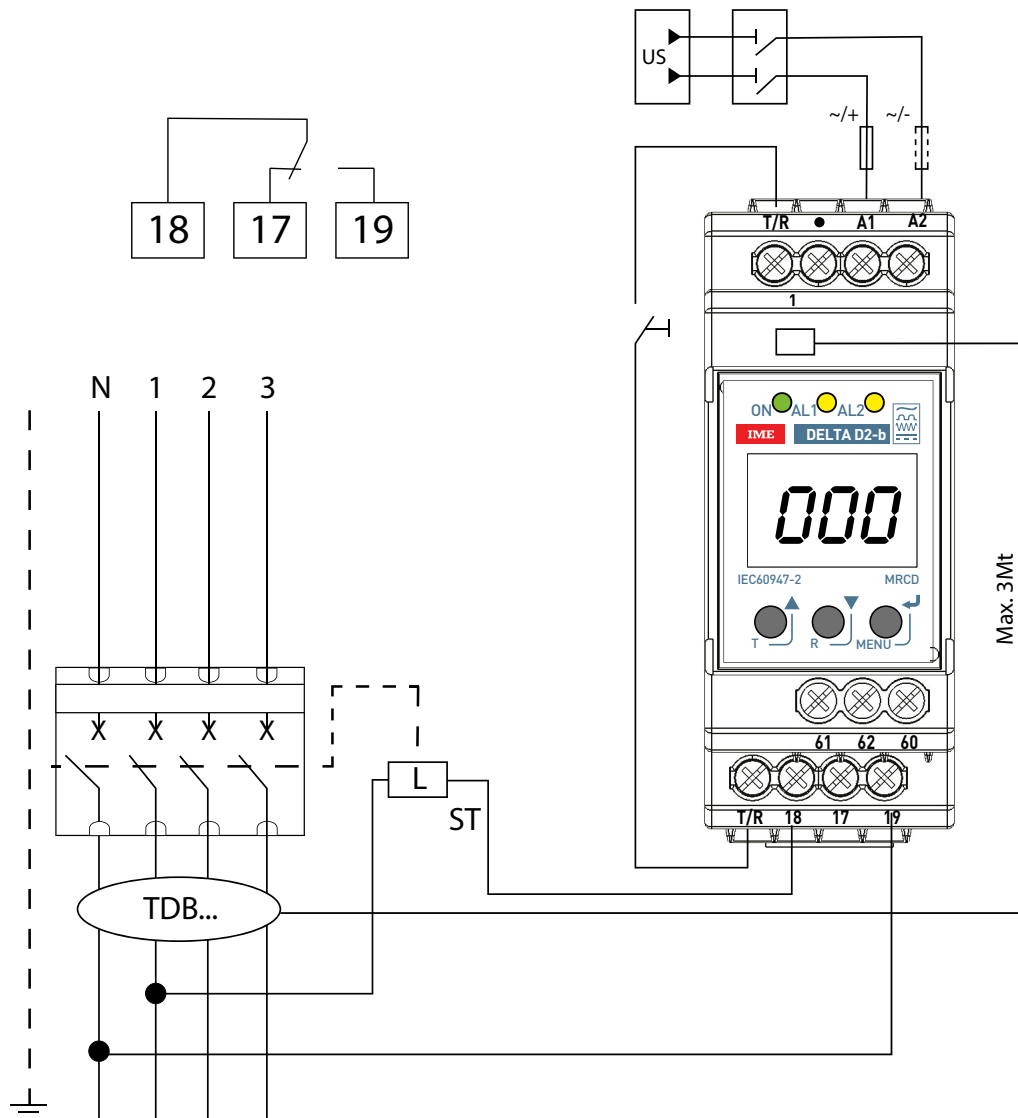

**Sicurezza negativa** contatto normalmente aperto

**N.O.** no apertura automatica in caso di mancanza tensione di alimentazione (Us)

**Negative safety** normally open contact

**N.O.** no automatic opening in case of lack of supply voltage (Us)

**Sécurité négatif** contact normalement ouvert

**N.O.** pas ouverture automatique en cas de manque tension d'alimentation (Us)

**Negativ Sicherheit** normalerweise offener Kontakt

**N.O.** kein automatisches Öffnen von Spannungsmangel Energieversorgung (Us)

**Seguridad negativa** contacto normalmente abierto

**N.O.** sin apertura automática en caso de falta voltaje de alimentación (Us)

• **Installazione • Installation • Installation • Installieren • Instalación**

**Il range di settaggio di IΔn sul toroide (TDB...) deve essere congruo con la soglia di sgancio programmata nel MRCD**

*The setup range of IΔn on the toroid (TDB...) must be consistent with the release threshold set in MRCD*

*La plage de réglage de IΔn sur le toroïde (TDB...) doit être cohérente avec le seuil de décrochage programmé dans le MRCD*

*Der Einstellbereich von IΔn am Ringstromwandler (TDB...) muss mit dem im MRCD programmierten Freigabeschwellenwert übereinstimmen*

*El rango de configuración de IΔn en el toroide (TDB...) ha de ser coherente con el umbral de desenganche programado en el MRCD*

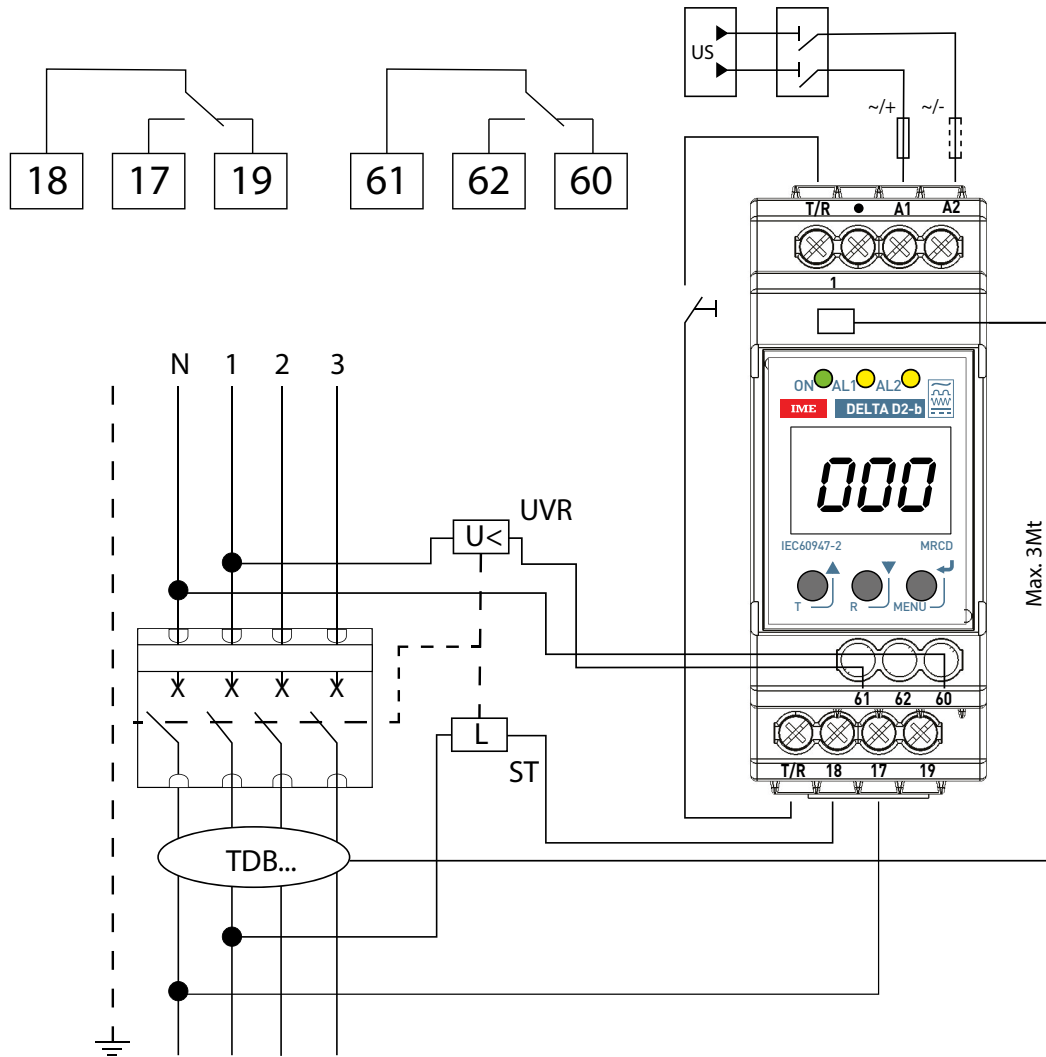

**Sicurezza positiva** contatto normalmente chiuso con strumento alimentato

**N.C.** apertura automatica in caso di mancanza tensione di alimentazione (Us)

**Positive safety** normally closed contact with powered instrument

**N.C.** automatic opening in case of lack of supply voltage (Us)

**Sécurité positive** contact normalement fermé avec instrument alimenté

**N.C.** ouverture automatique en cas de manque tension d'alimentation (Us)

**Positive Sicherheit** normalerweise geschlossener Kontakt mit angetriebenem Instrument

**N.C.** automatisches Öffnen von Spannungsmangel Energieversorgung (Us)

**Seguridad positiva** contacto normalmente cerrado con el instrumento conectado

**n.c.** apertura automática en caso de falta voltaje de alimentación (Us)

**Configurazione Avanzata con bobina aggiuntiva (UVR) per il consenso alla chiusura dell'interruttore programmando soglia: IΔn1 = 100% di IΔ2**

*Advanced configuration with additional coil (UVR) for the consent to the closure of the switch, programming the threshold: IΔn1 = 100% di IΔ2*

*Configuration Avancée avec bobine supplémentaire (UVR) pour l'autorisation de fermeture de l'interrupteur en programmant le seuil : IΔn1 = 100% de Δ2*

*Erweiterte Konfiguration mit zusätzlicher Spule (UVR) für die Zustimmung zum Schließen des Schalters über den programmierten Schwellenwert:*

*Δn1 = 100% di IΔ2*

*Configuración avanzada con bobina adicional (UVR) para el consentimiento al cierre del interruptor programado umbral: IΔn1 = 100% di IΔ2*

# Relè differenziale MRCD di tipo "B" Type "B" MRCD differential relay

## • Installazione • Installation • Installation • Installieren • Instalación

• Tabelle compatibilità • Compatibility tables • Tableau compatibilités • Kompatibilitätstabelle • Tabla de compatibilidad

MRCD Type B combinations according to EN / IEC 60947-2 Annex M for life-saving function with $I_{\Delta n}$ to 30mA				
DIN Device	RDBMRCD230			
	RDBMRCD24			
<u>Toroid</u>	TDB35			
	TDB60			
	TDB120			
	TDB210			
<u>Switches</u>		Release coil ST (Standard configuration)	Release coil UVR (Advanced configuration)	SET=> Rated residual Operating current ( $I_{\Delta n}$ 0,03A)
<u>Range Bticino Megatiker</u>	M1 160E	M7S024; M7S230	M7U024; M7U230	OK
	M1 160B			OK
	M1 160N			OK
	M2 250B			OK*
	M2 250F			OK*
	M2 250H			OK*
	M2 250B Ele			OK*
	M2 250N Ele			OK*
	M2 250H Ele			OK*
	M2 250B Ele+Measure			OK*
	M2 250F Ele+Measure	OK*		
	M2 250H Ele+Measure	OK*		
	M4 630F	M7C024; M7C230		
	M4 630N			
	M4 630L			
	M4 630F Ele			
	M4 630N Ele			
	M4 630L Ele			
	M4 630N Ele+Measure			
	M4 630L Ele+Measure			

MRCD Type B combinations according to EN / IEC 60947-2 Annex M for life-saving function with $I_{\Delta n}$ to 30mA				
DIN Device	RDBMRCD230			
	RDBMRCD24			
<u>Toroid</u>	TDB35			
	TDB60			
	TDB120			
	TDB210			
<u>Switches</u>		Release coil ST (Standard configuration)	Release coil UVR (Advanced configuration)	SET=> Rated residual Operating current ( $I_{\Delta n}$ 0,03A)
<u>Range DPX<sup>3</sup> Legrand</u>	DPX <sup>3</sup> 160 16kA	421013; 421016	421019; 421022	OK
	DPX <sup>3</sup> 160 25kA			OK
	DPX <sup>3</sup> 160 50kA			OK
	DPX <sup>3</sup> 250 25kA			OK*
	DPX <sup>3</sup> 250 36kA			OK*
	DPX <sup>3</sup> 250 70kA			OK*
	DPX <sup>3</sup> 250 25kA Ele			OK*
	DPX <sup>3</sup> 250 36kA Ele			OK*
	DPX <sup>3</sup> 250 70kA Ele			OK*
	DPX <sup>3</sup> 250 25kA Ele+Measure			OK*
	DPX <sup>3</sup> 250 36kA Ele+Measure	OK*		
	DPX <sup>3</sup> 250 70kA Ele+Measure	OK*		
	DPX <sup>3</sup> 630 36kA	422239; 422242		
	DPX <sup>3</sup> 630 50kA			
	DPX <sup>3</sup> 630 100kA			
	DPX <sup>3</sup> 630 36kA Ele			
	DPX <sup>3</sup> 630 50kA Ele			
	DPX <sup>3</sup> 630 100kA Ele			
	DPX <sup>3</sup> 630 50kA Ele+Measure			
	DPX <sup>3</sup> 630 100kA Ele+Medida			

\*  $I_{\Delta n}$  30mA applicabile fino a  $I_n = 160A$  \*  $I_{\Delta n}$  30mA applicable up to  $I_n = 160A$  \*  $I_{\Delta n}$  30mA applicable jusqu'à  $I_n = 160A$

\*  $I_{\Delta n}$  30mA anwendbar a  $I_n = 160A$  \*  $I_{\Delta n}$  30mA aplicabile hasta  $I_n = 160A$

## • Installazione • Installation • Installation • Installieren • Instalación

- Connessioni per collegamento MRCD e toroide (TDB...) • *MRCD and toroid (TDB...) connections*
- Connexions pour branchement MRCD et toroïde (TDB...) • *Anschlüsse für MRCD- und Ringstromwandler (TDB...)*
- Conexiones para acoplamiento MRCD y toroide (TDB...)

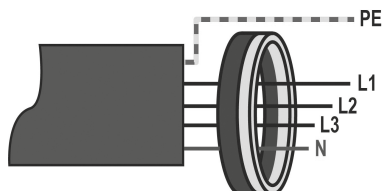
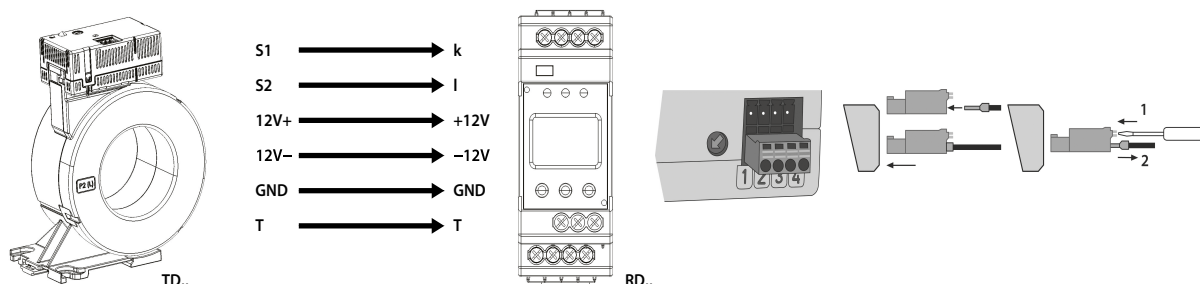

**Non far passare i cavi schermati attraverso il trasformatore di corrente di misura**

*Do not pass the shielded cables through the measurement current transformer*

*Ne pas faire passer les câbles blindés à travers le transformateur de courant de mesure.*

*Führen Sie keine geschirmten Kabel durch den Messstromwandler*

*No pasar los cables apantallados por el transformador de corriente de medición*

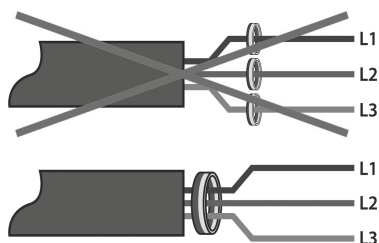

**Assicurarsi che tutti i cavi che portano corrente siano passanti attraverso il trasformatore di corrente di misura**

*Make sure that all the current cables go through the measurement current transformer*

*S'assurer que tous les câbles qui transportent du courant passent à travers le transformateur de courant de mesure*

*Achten Sie darauf, dass alle stromführenden Kabel durch den Messstromwandler geführt werden*

*Asegurarse de que todos los cables, que llevan corriente, pasen por el transformador de corriente de medición*

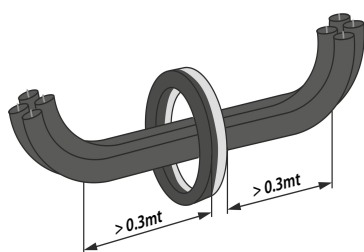

**I cavi possono essere piegati solo a distanza > 0.3mt dal trasformatore di corrente di misura**

*The cables may only be bent at distances > 0.3 mt from the measurement current transformer*

*Les câbles peut être pliés uniquement à une distance supérieure à 3 mètres du transformateur de courant de mesure*

*Kabel können nur in mehr als 0,3 m Entfernung vom Messstromwandler gebogen werden*

*Los cables pueden plegarse solo a una distancia > 0,3m del transformador de corriente de medición*

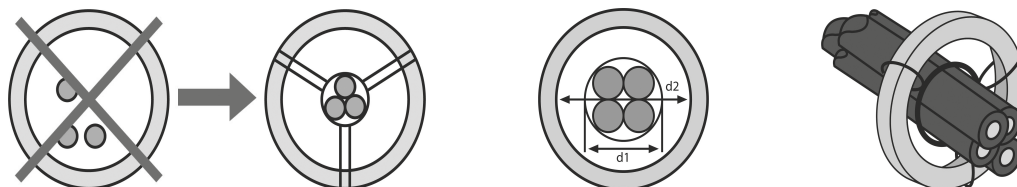

• **Utilizzo • Use • Utilisation • Verwendung • Utilización**

• **Navigazione pagine**

Visualizzazione automatica ogni 3s delle condizioni di sorveglianza:

- $I\Delta$  corrente differenziale istantanea
- Soglia di sgancio impostata  $I\Delta n$  2
- Ritardo di sgancio impostata  $\Delta t_2$

Visualizzazione TEST manuale

Visualizzazione anomalie

• **Page navigation**

Automatic display every 3 s of the monitoring conditions:

- $I\Delta$  instantaneous differential current
- Release threshold set  $I\Delta n$  2
- Release delay set  $\Delta t_2$

Display of the manual TEST

Display of the anomalies

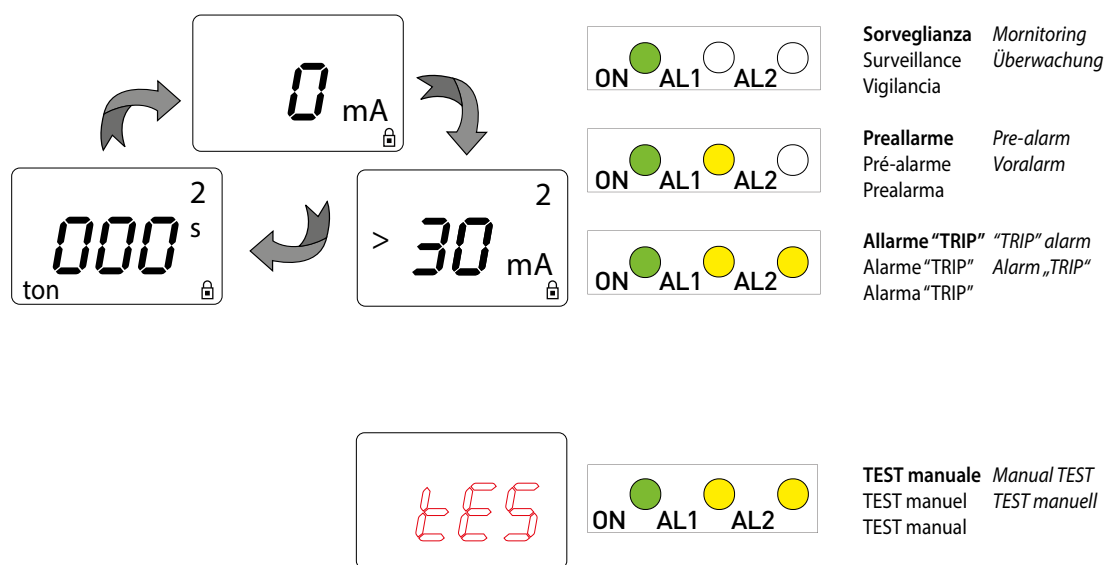

• **Pages de navigation**

Visualisation automatique toutes les 3 sec. des conditions de surveillance :

- $I\Delta$  courant différentiel instantané
- Seuil de décrochage programmé  $I\Delta n$  2
- Retard de décrochage programmé  $I\Delta n$  2

Visualisation TEST manuel

Visualisation anomalies

• **Durch die Seiten surfen**

Automatische Anzeige der Überwachungsbedingungen alle 3 Sekunden:

- Momentaner Differenzstrom  $I\Delta$
- Freigabeschwelle eingestellt  $I\Delta n$  2
- Freigabeverzögerung eingestellt  $I\Delta n$  2

Anzeige TEST manuell

Anzeige von Störungen

• **Navegación por las páginas**

Visualización automática cada 3s de las condiciones de vigilancia:

- $I\Delta$  corriente diferencial instantánea
- Umbral de desenganche configurado  $I\Delta n$  2
- Retraso de desenganche configurado  $I\Delta n$  2

Visualización TEST manual

Visualización anomalías

## • Programmazione • Programming • Programmation • Programmierung • Programación

- Tenendo premuto il tasto **MENU** per > 2s si accede alla visualizzazione dei parametri di setup
- *By keeping the **MENU** key pressed for > 2s you access the setup parameters display*
- En maintenant la touche **MENU** enfoncée pendant > 2s, vous accédez à l'affichage des paramètres de configuration
- *Wenn Sie die **MENU**-Taste länger als > 2s gedrückt halten, gelangen Sie zur Anzeige der Setup-Parameter*
- Manteniendo presionada la tecla **MENU** durante > 2s, accede a la pantalla de parámetros de configuración

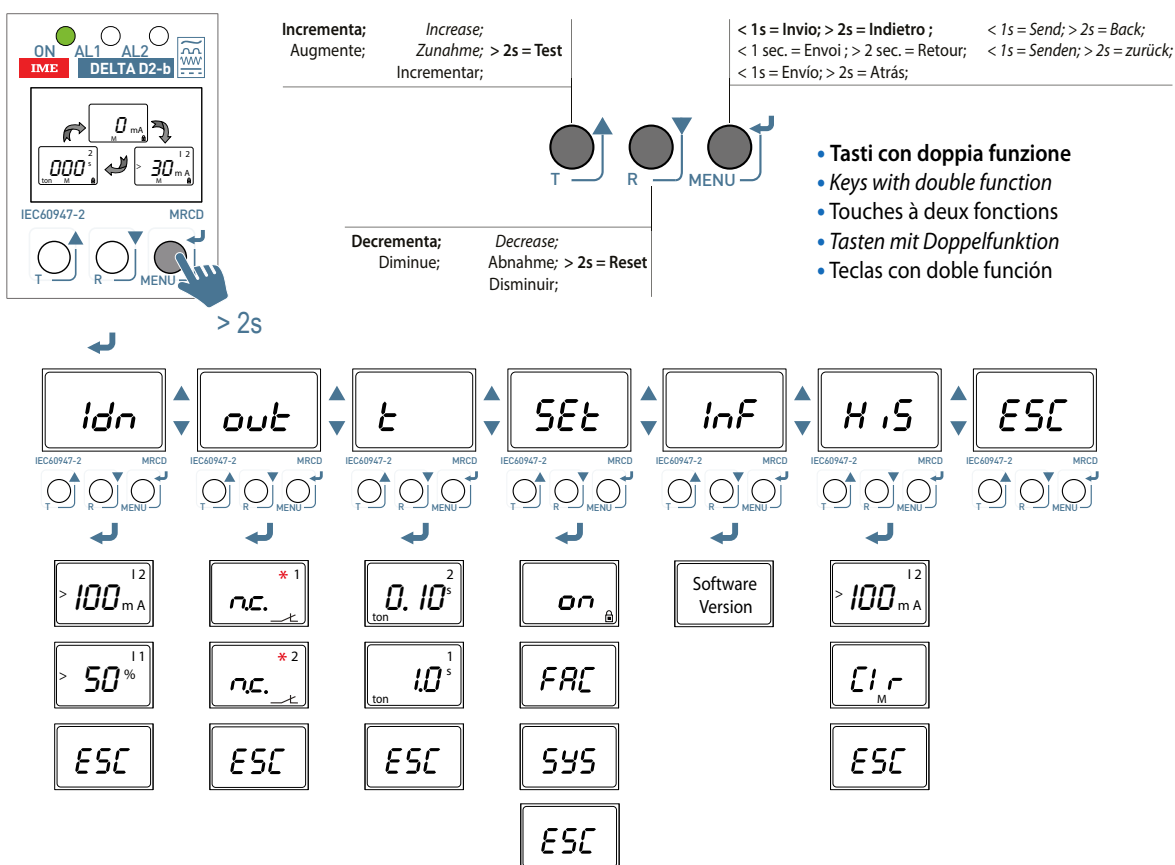

**Incrementa;** Increase; **> 2s = Test**  
 Augmente; Zunahme; Incrementar;

**Decrementa;** Decrease; **> 2s = Reset**  
 Diminue; Abnahme; Disminuir;

< 1s = Invio; > 2s = Indietro; < 1s = Send; > 2s = Back;  
 < 1 sec. = Envoi; > 2 sec. = Retour; < 1s = Senden; > 2s = zurück;  
 < 1s = Envío; > 2s = Atrás;

- **Tasti con doppia funzione**
- *Keys with double function*
- *Touches à deux fonctions*
- *Tasten mit Doppelfunktion*
- *Teclas con doble función*

	Range	Default
Out	n.c./n.o. * 1 Pre-Alarm	n.c.
	n.c./n.o. * 2 Trip	n.c.
I2 (IΔn2)	30mA...3A	100mA
I1 (IΔn1)	50%...100% IΔn2	50%
ton2 (Δt2)	0s...10s	0.1s
ton1 (Δt1)	0s...10s	1s
Password	0...999	0

n.c.	Sicurezza Positiva
	Positive Safety.
	Sécurité Positive
	Positive Sicherheit
n.o.	Seguridad Positiva
	Sicurezza negativa
	Negative Safety.
	Sécurité Négative
n.o.	Negative Sicherheit
	Seguridad Negativa
	Seguridad Negativa

• Programmazione • Programming • Programmation • Programmierung  
• Programación

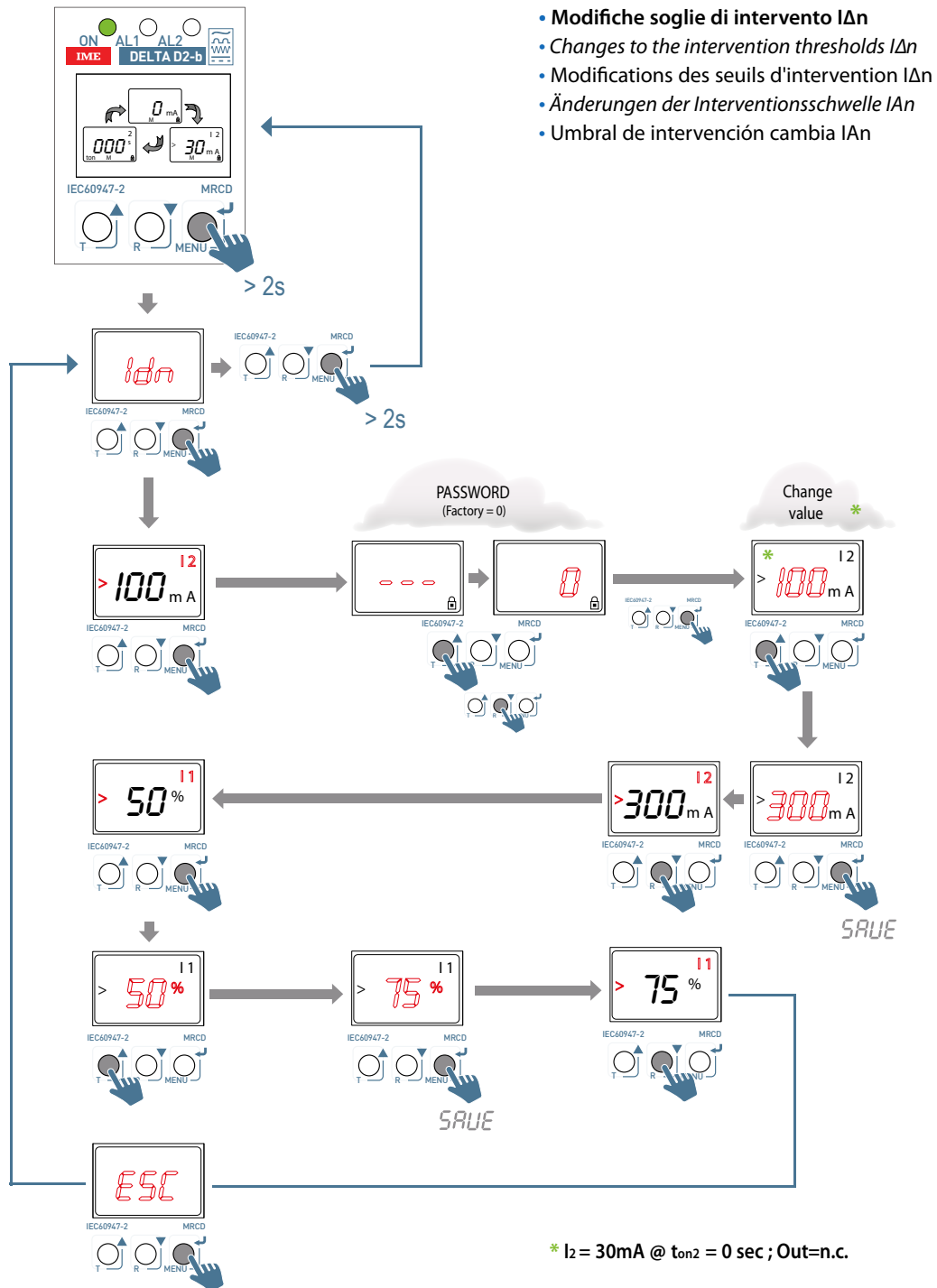

• Programmazione • Programming • Programmation • Programmierung  
• Programación

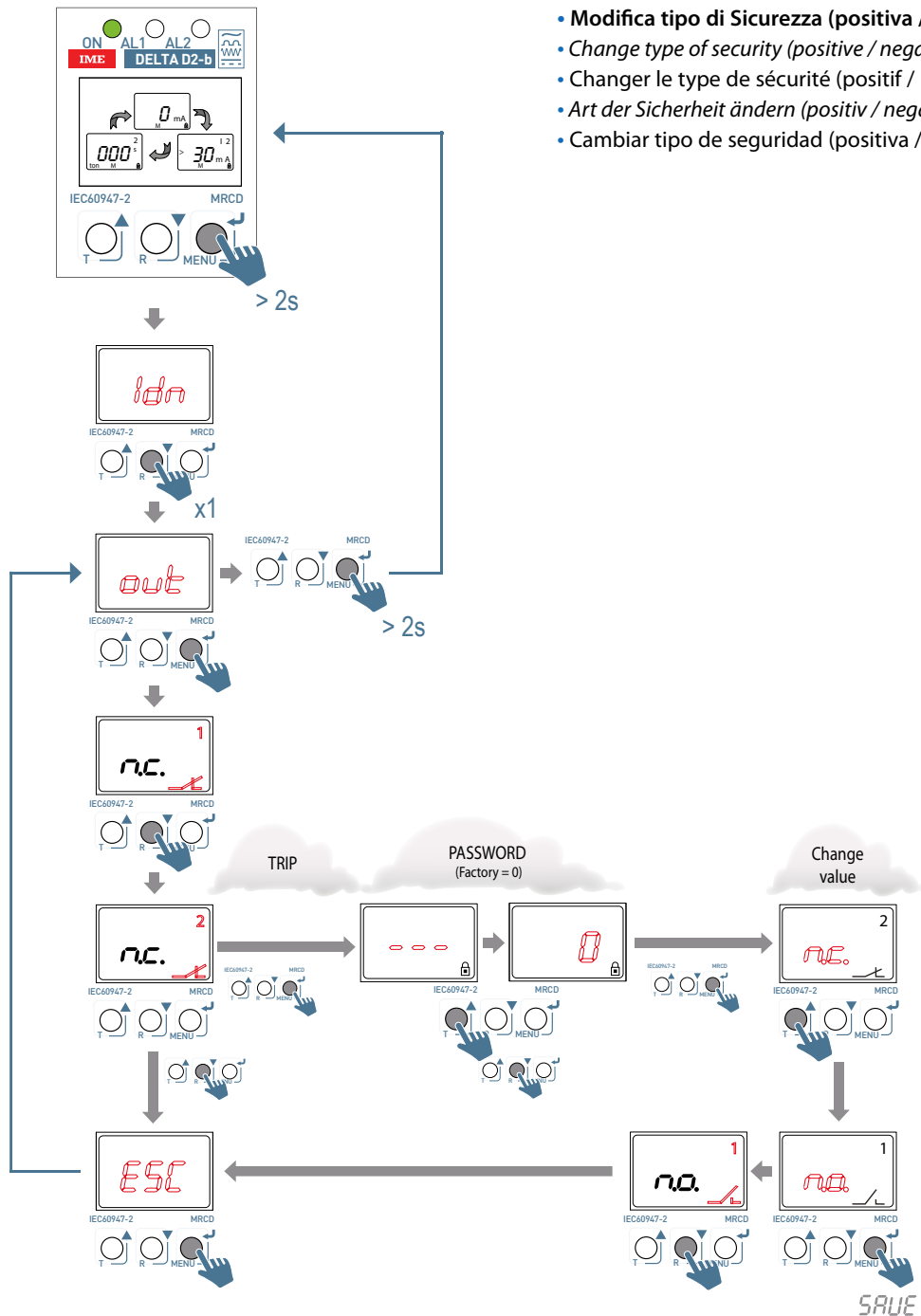

- Modifica tipo di Sicurezza (positiva / negativa)
- Change type of security (positive / negative)
- Changer le type de sécurité (positif / négatif)
- Art der Sicherheit ändern (positiv / negativ)
- Cambiar tipo de seguridad (positiva / negativa)



• Programmazione • Programming • Programmation • Programmierung  
• Programación

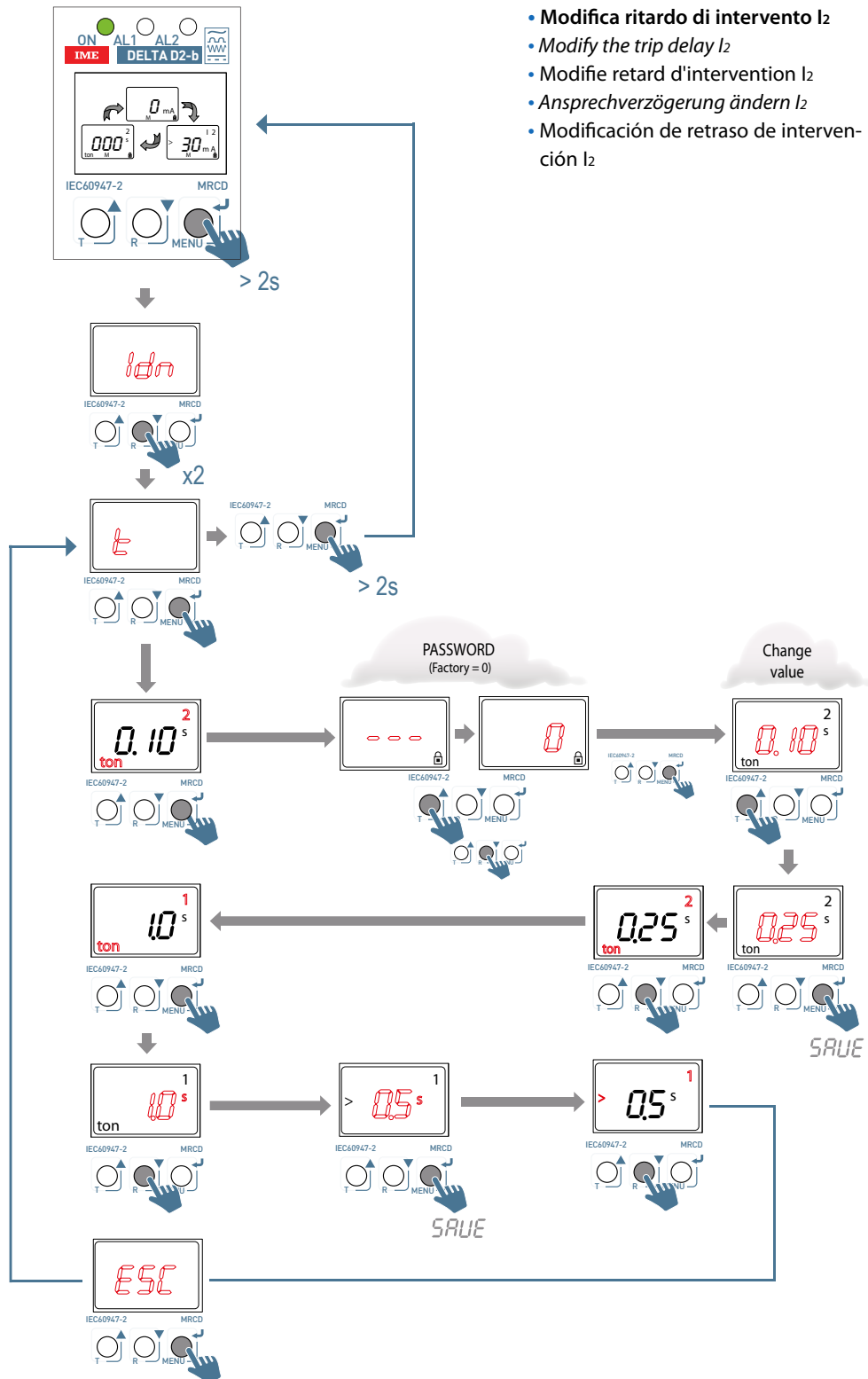

- Modifica ritardo di intervento I<sub>2</sub>
- Modify the trip delay I<sub>2</sub>
- Modifie retard d'intervention I<sub>2</sub>
- Ansprechverzögerung ändern I<sub>2</sub>
- Modificación de retraso de intervención I<sub>2</sub>

• Programmazione • Programming • Programmation • Programmierung  
• Programación

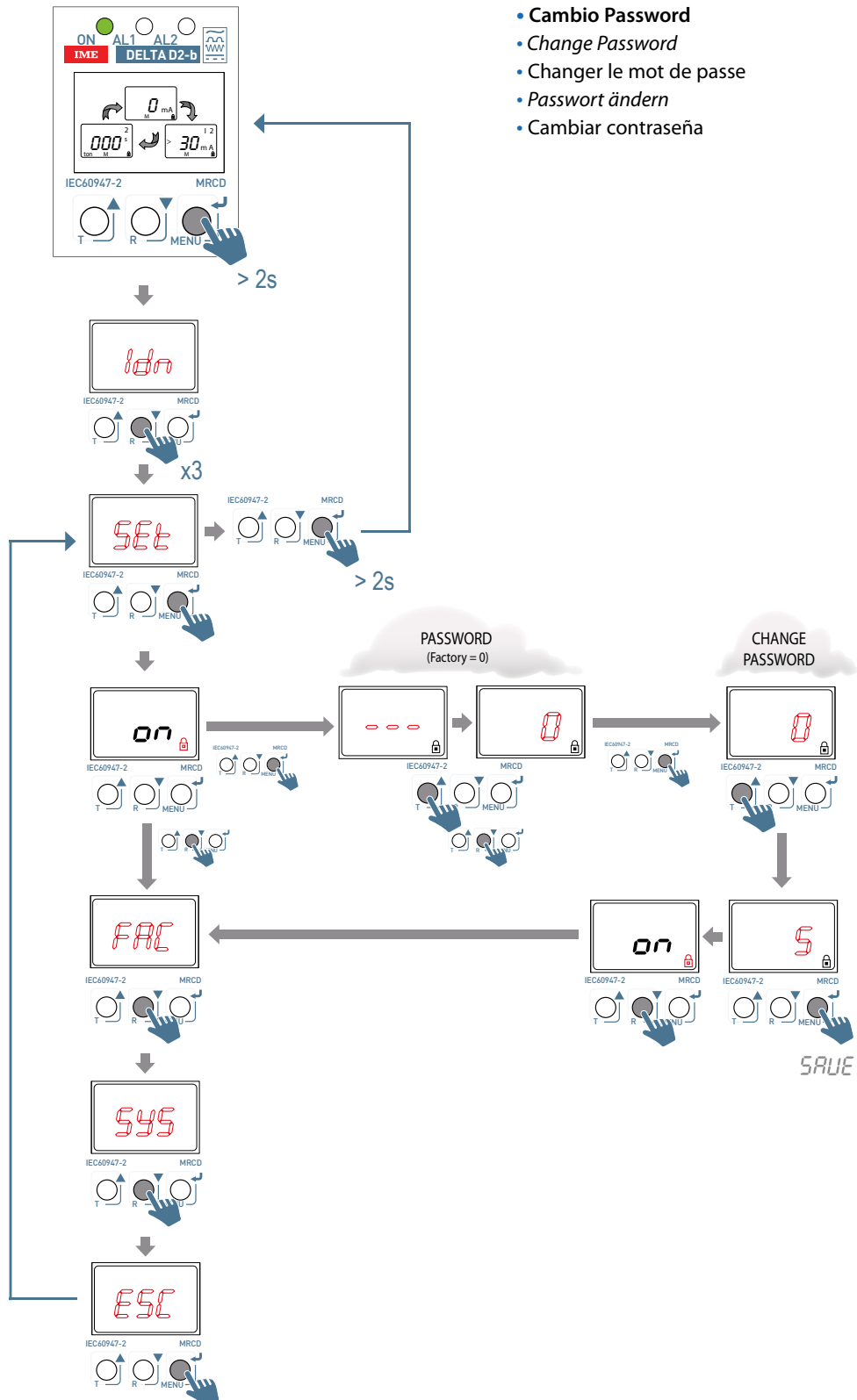

• Programmazione • Programming • Programmation • Programmierung  
• Programación

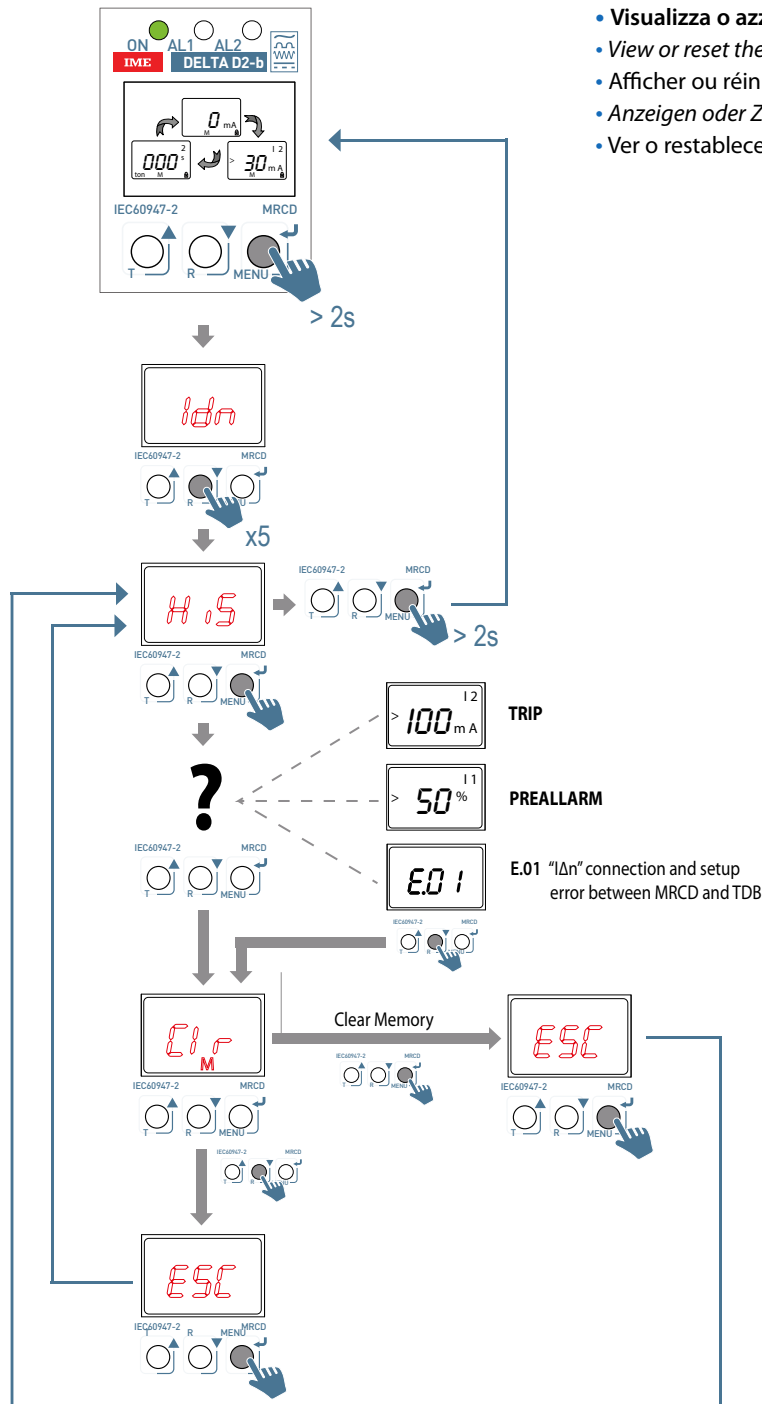

- Visualizza o azzerà il primo allarme memorizzato
- View or reset the first stored alarm
- Afficher ou réinitialiser la première alarme enregistrée
- Anzeigen oder Zurücksetzen des ersten gespeicherten Alarms
- Ver o restablecer la primera alarma almacenada

## • Diagnostica • Diagnosis • Surveillance • Überwachung • Vigilancia

- Test Manuale
- Manual TEST
- TEST manuel
- TEST manuell
- TEST manual

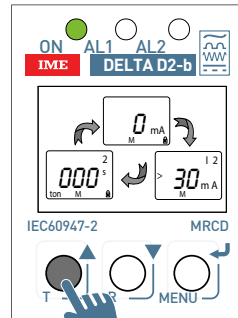

> 2s

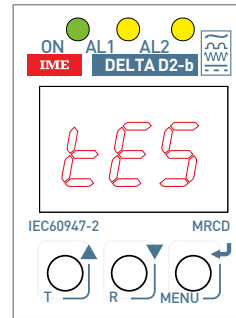

15s

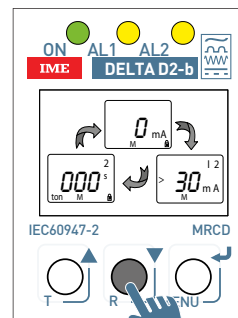

• Reset > 2s

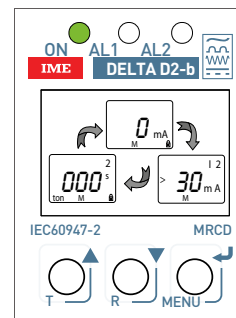

- Anomalia di funzionamento
  - E.01 Errore di collegamento o settaggio "IΔn" tra MRCD e TDB
  - E.02 Errore durante il TEST manuale

- Operating anomaly

- E.01 "IΔn" connection and setup error between MRCD and TDB
- E.02 Error during the manual TEST

- Anomalie de fonctionnement

- E.01 Erreur de branchement et réglage « IΔn » entre MRCD et TDB
- E.02 Erreur pendant le TEST manuel

- Betriebsstörung

- E.01 Verbindungs- und Einstellungsfehler „IΔn“ zwischen MRCD und TDB
- E.02 Fehler beim manuellen TEST

- Anomalia de funcionamiento

- E.01 Error de conexión y configuración "IΔn" entre MRCD y TDB
- E.02 Error durante el TEST manual

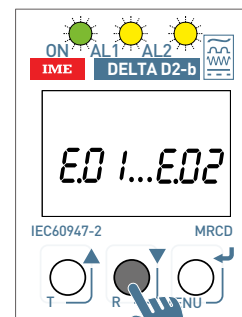

> 2s

RESET

## • Caratteristiche tecniche

Involucro										
Dimensioni (l x h x p)	35,8 x 92,4 x 64mm									
Collegamenti	<table border="1"> <tr> <td style="text-align: center;"></td> <td>   </td> <td>Recommended torque 0,5Nm COMBI PZ2 </td> </tr> <tr> <td style="text-align: center;"></td> <td>   </td> <td>Recommended torque 0,2Nm 0,6 x 3,5mm </td> </tr> <tr> <td style="text-align: center;"></td> <td>     </td> <td>WIRE CLASS AWG 24...16 AWG 24...16 AWG 24...19</td> </tr> </table>		 	Recommended torque 0,5Nm COMBI PZ2 		 	Recommended torque 0,2Nm 0,6 x 3,5mm 		  	WIRE CLASS AWG 24...16 AWG 24...16 AWG 24...19
	 	Recommended torque 0,5Nm COMBI PZ2 								
	 	Recommended torque 0,2Nm 0,6 x 3,5mm 								
	  	WIRE CLASS AWG 24...16 AWG 24...16 AWG 24...19								
Grado di protezione RDBMRCD:	Componenti interni IP30, Morsetti IP20									
Grado di protezione TDB...:	Componenti custodia IP40, Morsetti IP20									
Peso RDBMRCD:	220 g									
Peso TDB...:	Ø35 = 40 g - Ø60 = 70 g - Ø120 = 165 g - Ø210 = 465 g									
Display										
Tipo:	LCD a 3 cifre (1000 punti)									
Alimentazione ausiliaria										
Tempo d'inibizione all'accensione:	1,2 s									
<b>RDBMRCD230</b>	Us:	100...250V AC/DC								
	Variazione ammessa:	70...300V AC/DC								
	Frequenza ammessa:	42...460Hz								
	Autoconsumo:	< 6,5VA								
<b>RDBMRCD24</b>	Us:	24...60V AC @ 24...78V DC								
	Variazione ammessa:	16...72V AC @ 9,6...94V DC								
	Frequenza ammessa:	42...460Hz								
	Autoconsumo:	< 6,5VA								
Misura										
Forma d'onda di tip B secondo la EN/IEC 60947-2 (annexM)										
Corrente differenziale I $\Delta$ n:	0,3...3A									
Frequenza di funzionamento	0...2 kHz									
Condizioni di utilizzo										
Portata contatto relè di uscita (EN/IEC 60947-5-1)	230Vac 5A (AC-13) - 24Vdc 1A (DC-12)									
Temperatura ambiente di funzionamento:	(-25°C) ÷ (55°C) [-13°F ÷ 131°F]									
Temperatura ambiente di immagazzinamento:	(-25°C) ÷ (70°C) [-13°F ÷ 158°F]									
Massima potenza dissipata:	6,5 W									

## • Caratteristiche tecniche











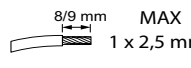
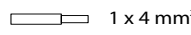

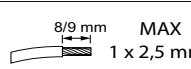



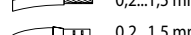
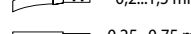

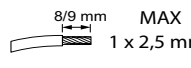
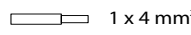

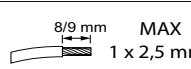

Marcatura CE	
I dispositivi <b>RDBMRCD230 - RDBMRC24</b> sono conformi: <ul style="list-style-type: none"> <li>• Alla Direttiva 2011/65/EU modificata dalla direttiva 2015/863 (RoHS 2).</li> <li>• Al Regolamento REACH (1907/2006): alla data di pubblicazione di questo documento, nessuna sostanza inserita nell'allegato XIV è presente all'interno di questi prodotti.</li> <li>• Alla Direttiva RAEE(2012/19/UE): direttiva Europea sui rifiuti di apparecchiature elettriche ed elettroniche.</li> </ul>	
Compatibilità elettromagnetica	
Prove in accordo con IEC/EN 60947-2 (annex M)	
Isolamento (IEC/EN 60947-1)	
Categoria di misura:	III
Grado d'inquinamento:	2
Rigidità dielettrica:	Alimentazione / Uscite: 2,2kV
Tensione d'isolamento, Ui:	<b>RDBMRCD230:</b> 250V <b>RDBMRCD24:</b> 100V
Tenuta all'impulso Uimp:	<b>RDBMRCD230:</b> 4kV <b>RDBMRCD24:</b> 2,5kV

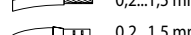
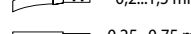
## • Elenco delle abbreviazioni

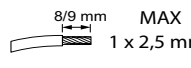
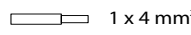
IA	Corrente differenziale istantanea
I <sub>2</sub>	Corrente di intervento differenziale (mA/A)
I <sub>1</sub>	Valore di intervento differenziale in % di I <sub>2</sub> (Preallarme)
ton <sub>2</sub>	Ritardo di intervento (ms/sec), (TRIP)
ton <sub>1</sub>	Ritardo di intervento (ms/sec), (Preallarme)
Idn	Modifica del valore di intervento
t	Modifica del ritardo di intervento
SEt	Impostazioni
On	Impostazione della password ON / OFF
FAC	Impostazioni di fabbrica
SYS	Non disponibile
InF	Versione Software
HiS	Visualizza o azzerà il primo allarme memorizzato
CLr	Cancella la cronologia recente
N.C.	Normalmente chiuso (sicurezza positiva)
N.O.	Normalmente aperto (sicurezza negativa)

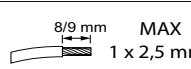
## Relè differenziale MRCD di tipo "B" Type "B" MRCD differential relay

### • Technical characteristics

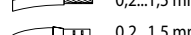
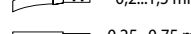
<b>Housing</b>										
Dimension (l x h x p)	35,8 x 92,4 x 64mm									
Connections	<table border="1" style="width: 100%; border-collapse: collapse;"> <tr> <td style="text-align: center;"></td> <td>    </td> <td>                     Recommended torque 0,5Nm                      COMBI PZ2   </td> </tr> <tr> <td style="text-align: center;"></td> <td>    </td> <td>                     Recommended torque 0,2Nm                      0,6 x 3,5mm   </td> </tr> <tr> <td style="text-align: center;"></td> <td>      </td> <td>                     WIRE CLASS                      AWG 24...16                      AWG 24...16                      AWG 24...19                 </td> </tr> </table>		 	Recommended torque 0,5Nm COMBI PZ2 		 	Recommended torque 0,2Nm 0,6 x 3,5mm 		  	WIRE CLASS AWG 24...16 AWG 24...16 AWG 24...19
	 	Recommended torque 0,5Nm COMBI PZ2 								
	 	Recommended torque 0,2Nm 0,6 x 3,5mm 								
	  	WIRE CLASS AWG 24...16 AWG 24...16 AWG 24...19								
Degree of protection <b>RDBMRCD:</b>	Internal components IP30, Terminals IP20									
Degree of protection <b>TDB...:</b>	Housing components IP40, Terminals IP20									
Weight <b>RDBMRCD:</b>	220 g									
Weight <b>TDB...:</b>	Ø35 = 40 g - Ø60 = 70 g - Ø120 = 165 g - Ø210 = 465 g									
<b>Display</b>										
Type:	3-digit LCD (1000 points)									
<b>Auxiliary supply</b>										
Power ON inhibition time:	1,2 s									
<b>RDBMRCD230</b>	Us:	100...250V AC/DC								
	Permitted variation:	70...300V AC/DC								
	Permitted frequency:	42...460Hz								
	Self consumption:	< 6,5VA								
<b>RDBMRCD24</b>	Us:	24...60V AC @ 24...78V DC								
	Permitted variation:	16...72V AC @ 9,6...94V DC								
	Permitted frequency:	42...460Hz								
	Self consumption:	< 6,5VA								
<b>Measurement</b>										
B type wave according to EN/IEC 60947-2 (annex M)										
Differential current I $\Delta$ n:	0,3...3A									
Operating frequency:	0...2 kHz									
<b>Operating conditions</b>										
Output relay contact capacity (EN/IEC 60947-5-1)	230Vac 5A (AC-13) - 24Vdc 1A (DC-12)									
Operating temperature:	(-25°C) ÷ (55°C) [-13°F ÷ 131°F]									
Room storage temperature:	(-25°C) ÷ (70°C) [-13°F ÷ 158°F]									
Maximum power consumption:	6,5 W									

## • Technical characteristics











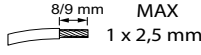
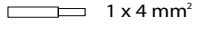

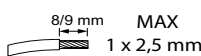
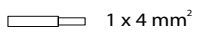



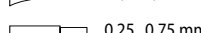
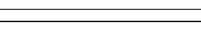

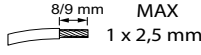
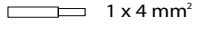

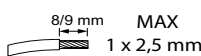
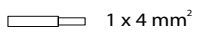

CE Marking	
<p>The <b>RDBMRCD230 - RDBMRC24</b> devices comply:</p> <ul style="list-style-type: none"> <li>• with the 2011/65/EU Directive, as amended by the 2015/863 (RoHS 2) Directive.</li> <li>• with the REACH Regulation (1907/2006): at the date of publication of this document no substance in the annex XIV is found in these products.</li> <li>• with the RAEE (2012/19/UE) Directive: European Directive on electric and electronic waste.</li> </ul>	
Electromagnetic compatibility	
Tests in accordance with IEC/EN 60947-2 (annex M)	
Insulation (IEC/EN 60947-1)	
Measurement category:	III
Level of pollution:	2
Dielectric rigidity:	Power supply / Outputs: 2.2kV
Insulation voltage, $U_i$ :	<b>RDBMRCD230:</b> 250V <b>RDBMRCD24:</b> 100V
Impulse withstand voltage, $U_{imp}$ :	<b>RDBMRCD230:</b> 4kV <b>RDBMRCD24:</b> 2,5kV

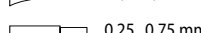
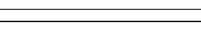
## • Glossary of abbreviations

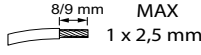
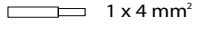
$I\Delta$	Instantaneous differential current
$I_2$	Differential trip current (mA)
$I_1$	Differential trip value in % di $I_2$ (Pre-Alarm)
$ton_2$	Trip delay (ms/sec), (TRIP)
$ton$	Trip delay (ms/sec), (Pre-Alarm)
$I_{dn}$	Modify the trip value
$t$	Modify the trip delay
SEt	Settings
On	ON / OFF password setting
FAC	Factory settings
SYS	Not available
InF	Software / Hardware Version
HiS	View or reset the first stored alarm
CLr	Delete recent history
N.C.	Normally closed (positive safety)
N.O.	Normally open (negative safety)

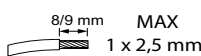
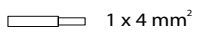

## • Caractéristiques techniques

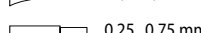
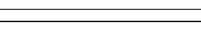
Boîtier										
Dimensions (l x h x p)	35,8 x 92,4 x 64mm									
Raccordement:	<table border="1"> <tr> <td></td> <td>    </td> <td>                     Recommended torque 0,5Nm                      COMBI PZ2   </td> </tr> <tr> <td></td> <td>    </td> <td>                     Recommended torque 0,2Nm                      0,6 x 3,5mm   </td> </tr> <tr> <td></td> <td>      </td> <td>                     WIRE CLASS                      AWG 24...16                      AWG 24...16                      AWG 24...19                 </td> </tr> </table>		 	Recommended torque 0,5Nm COMBI PZ2 		 	Recommended torque 0,2Nm 0,6 x 3,5mm 		  	WIRE CLASS AWG 24...16 AWG 24...16 AWG 24...19
	 	Recommended torque 0,5Nm COMBI PZ2 								
	 	Recommended torque 0,2Nm 0,6 x 3,5mm 								
	  	WIRE CLASS AWG 24...16 AWG 24...16 AWG 24...19								
Indice de protection: RDBMRCD:	Composants internes IP30, Bornes IP20									
Indice de protection: TDB...:	Composants habillage IP40, Bornes IP20									
Poids RDBMRCD:	220 g									
Poids TDB...:	Ø35 = 40 g - Ø60 = 70 g - Ø120 = 165 g - Ø210 = 465 g									
Afficheur										
Type:	LCD à 3 chiffres (1000 points)									
Alimentation auxiliaire										
Temps d'inhibition d'allumage:	1,2 s									
RDBMRCD230	Us:	100...250V AC/DC								
	Variation admise:	70...300V AC/DC								
	Fréquence admise:	42...460Hz								
	Auto-consommation :	< 6,5VA								
RDBMRCD24	Us:	24...60V AC @ 24...78V DC								
	Variation admise:	16...72V AC @ 9,6...94V DC								
	Fréquence admise:	42...460Hz								
	Auto-consommation :	< 6,5VA								
Mesure										
Forme d'onde de type B conforme à la norme EN/IEC 60947-2 (annexe M)										
Courant différentiel IΔn:	0,3...3A									
Fréquence de fonctionnement:	0...2 kHz									
Conditions d' utilisation										
Portée contact relai de sortie (EN/IEC 60947-5-1)	230Vac 5A (AC-13) - 24Vdc 1A (DC-12)									
Température ambiante de fonctionnement:	(-25°C) ÷ (55°C) [-13°F ÷ 131°F]									
Température ambiante de stockage :	(-25°C) ÷ (70°C) [-13°F ÷ 158°F]									
Puissance maximum dissipée :	6,5 W									











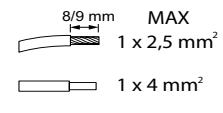

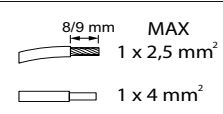

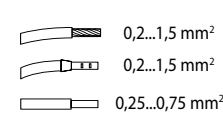

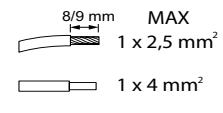
## • Caractéristiques techniques

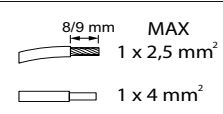
Marquage CE	
<p>Les dispositifs <b>RDBMRCD230 - RDBMRC24</b> sont conformes :</p> <ul style="list-style-type: none"> <li>• A la Directive 2011/65/EU modifiée par la directive 2015/863 (RoHS 2).</li> <li>- Au règlement REACH (1907/2006) : à la date de publication du présent document, aucune substance mentionnée dans l'annexe XIV n'est présente dans les produits.</li> <li>• A la Directive DEEE (2012/19/UE) : directive européenne sur les déchets d'équipements électriques et électroniques</li> </ul>	
Compatibilité électromagnétique	
Tests conformes à la norme IEC/EN 60947-2 (annexe M)	
Isolation (IEC/EN 60947-1)	
Catégorie de mesure:	III
Degré de pollution:	2
Rigidité diélectrique:	Alimentation / Sorties: 2,2kV
Tension d'isolation, Ui:	<b>RDBMRCD230:</b> 250V <b>RDBMRCD24:</b> 100V
Tenue à l'impulsion Uimp:	<b>RDBMRCD230:</b> 4kV <b>RDBMRCD24:</b> 2,5kV

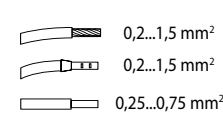
## • Lexique des abréviations

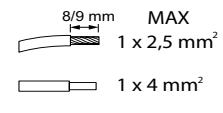
IΔ	Courant différentiel instantané
I2	Courant d'intervention différentiel (mA)
I1	Valeur d'intervention différentiel en % de I2 (Pré-alarme)
ton2	Retard d'intervention (ms/sec.), (TRIP)
ton1	Retard d'intervention (ms/sec.), (Pré-alarm)
Idn	Modification de la valeur d'intervention
t	Modification du retard d'intervention
SEt	Réglages
On	Réglage du mot de passe ON / OFF
FAC	Réglages par défaut
SYS	Non disponible
InF	Version Logiciel / Hardware
HiS	Afficher ou réinitialiser la première alarme enregistrée
CLr	Effacement de la chronologie récente
N.C.	Normalement fermé (sécurité positive)
N.O.	Normalement ouvert (sécurité négative)

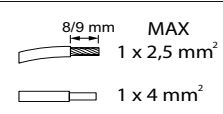
## • Technische Daten

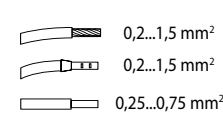
Gehäuse										
Abmessung (l x h x p)	35,8 x 92,4 x 64mm									
Anschlüsse	<table border="1" style="width: 100%; border-collapse: collapse;"> <tr> <td style="text-align: center;"></td> <td style="text-align: center;">  </td> <td style="text-align: center;">                     Recommended torque 0,5Nm COMBI PZ2  </td> </tr> <tr> <td style="text-align: center;"></td> <td style="text-align: center;">  </td> <td style="text-align: center;">                     Recommended torque 0,2Nm 0,6 x 3,5mm  </td> </tr> <tr> <td style="text-align: center;"></td> <td style="text-align: center;">  </td> <td style="text-align: center;">                     WIRE CLASS AWG 24...16 AWG 24...16 AWG 24...19                 </td> </tr> </table>			Recommended torque 0,5Nm COMBI PZ2 			Recommended torque 0,2Nm 0,6 x 3,5mm 			WIRE CLASS AWG 24...16 AWG 24...16 AWG 24...19
		Recommended torque 0,5Nm COMBI PZ2 								
		Recommended torque 0,2Nm 0,6 x 3,5mm 								
		WIRE CLASS AWG 24...16 AWG 24...16 AWG 24...19								
Schutzklasse <b>RDBMRCD</b> :	Interne Komponenten IP30, Klemmen IP20									
Schutzklasse <b>TDB...</b> :	Gehäusekomponenten IP40, Klemmen IP20									
Gewicht <b>RDBMRCD</b> :	220 g									
Gewicht <b>TDB...</b> :	Ø35 = 40 g - Ø60 = 70 g - Ø120 = 165 g - Ø210 = 465 g									
Display										
Typ:	LCD 3-stellig (1000 Punkte)									
Hilfsspannung										
Zündsperrzeit:	1,2 s									
<b>RDBMRCD230</b>	Us:	100...250V AC/DC								
	Zulässige Abweichung:	70...300V AC/DC								
	Zulässige Frequenz:	42...460Hz								
	Eigenverbrauch:	< 6,5VA								
<b>RDBMRCD24</b>	Us:	24...60V AC @ 24...78V DC								
	Zulässige Abweichung:	16...72V AC @ 9,6...94V DC								
	Zulässige Frequenz:	42...460Hz								
	Eigenverbrauch:	< 6,5VA								
Messung										
Wellenform des Typs B nach EN/IEC 60947-2 (Anhang M)										
Differentialstrom IΔn:	0,3...3A									
Arbeitsfrequenz:	0...2 kHz									
Gebrauchsbedingungen										
Kontaktbelastung des Ausgangsrelais (EN/IEC 60947-5-1)	230Vac 5A (AC-13) - 24Vdc 1A (DC-12)									
Betriebstemperatur:	(-25°C) ÷ (55°C) [-13°F ÷ 131°F]									
Lagertemperatur:	(-25°C) ÷ (70°C) [-13°F ÷ 158°F]									
Maximale Verlustleistung:	6,5 W									





































## • Technische Daten

CE-Kennzeichnung	
<p>Die Geräte <b>RDBMRCD230 - RDBMRC24</b> entsprechen:</p> <ul style="list-style-type: none"> <li>• Der Richtlinie 2011/65/EG geändert durch Richtlinie 2015/863 (RoHS 2).</li> <li>• Der REACH-Verordnung (1907/2006): Zum Zeitpunkt der Veröffentlichung dieses Dokuments ist kein in Anhang XIV enthaltener Stoff in diesen Produkten enthalten.</li> <li>• Der WEEE-Richtlinie (2012/19/EU): Europäische Richtlinie über Elektro- und Elektronik-Altgeräte.</li> </ul>	
Elektromagnetische Verträglichkeit	
Prüfungen gemäß IEC/EN 60947-2 (Anhang M)	
Isolation (IEC/EN 60947-1)	
Messkategorie:	III
Verschmutzungsgrad:	2
Durchschlagfestigkeit:	Speisung / Ausgänge: 2,2kV
Isolationsspannung, $U_i$ :	<b>RDBMRCD230:</b> 250V <b>RDBMRC24:</b> 100V
Impulsdauer $U_{imp}$ :	<b>RDBMRCD230:</b> 4kV <b>RDBMRC24:</b> 2,5kV

## • Abkürzungsliste

$I\Delta$	Momentaner Differenzstrom
$I_2$	Differentieller Auslösestrom (mA)
$I_1$	Differentieller Auslösewert in % von $I_2$ (Voralarm)
$ton_2$	Auslöseverzögerung (ms/sec), (TRIP)
$ton_1$	Auslöseverzögerung (ms/sec), (Voralarm)
$I_{dn}$	Ändern des Auslösewertes
$t$	Ändern Auslöseverzögerung
SEt	Einstellungen
On	Passworteinstellung ON / OFF
FAC	Werkseitige Einstellungen
SYS	Nicht verfügbar
InF	Software / / Hardware Version
HiS	Anzeigen oder Zurücksetzen des ersten gespeicherten Alarms
CLr	Löschen des aktuellen Registers
N.C.	Normalerweise geschlossen (positive Sicherheit)
N.O.	Normalerweise offen (negative Sicherheit)

## • Características técnicas

Caja										
Dimensiones (l x h x p)	35,8 x 92,4 x 64mm									
Conexiones	<table border="1"> <tr> <td></td> <td>    </td> <td>                     Recommended torque 0,5Nm                      COMBI PZ2   </td> </tr> <tr> <td></td> <td>    </td> <td>                     Recommended torque 0,2Nm                      0,6 x 3,5mm   </td> </tr> <tr> <td></td> <td>      </td> <td>                     WIRE CLASS                      AWG 24...16                      AWG 24...16                      AWG 24...19                 </td> </tr> </table>		 	Recommended torque 0,5Nm COMBI PZ2 		 	Recommended torque 0,2Nm 0,6 x 3,5mm 		  	WIRE CLASS AWG 24...16 AWG 24...16 AWG 24...19
	 	Recommended torque 0,5Nm COMBI PZ2 								
	 	Recommended torque 0,2Nm 0,6 x 3,5mm 								
	  	WIRE CLASS AWG 24...16 AWG 24...16 AWG 24...19								
Grado de protección RDBMRCD:	Componentes internos IP30, Bornes IP20									
Grado de protección TDB...:	Componentes funda IP40, Bornes IP20									
Peso RDBMRCD:	220 g									
Peso TDB...:	Ø35 = 40 g - Ø60 = 70 g - Ø120 = 165 g - Ø210 = 465 g									
Pantalla										
Type:	LCD de 3 cifras (1000 puntos)									
Alimentación auxiliar										
Tiempo de inhibición de ignición:	1,2 s									
RDBMRCD230	Us:	100...250V AC/DC								
	Variación admitida:	70...300V AC/DC								
	Frecuencia admitida:	42...460Hz								
	Autoconsumo:	< 6,5VA								
RDBMRCD24	Us:	24...60V AC @ 24...78V DC								
	Variación admitida:	16...72V AC @ 9,6...94V DC								
	Frecuencia admitida:	42...460Hz								
	Autoconsumo:	< 6,5VA								
Medida										
Forma de onda de tipo B según la EN/IEC 60947-2 (anexo M)										
Corriente diferencial IΔn:	0,3...3A									
Frecuencia de funcionamiento	0...2 kHz									
Condiciones de uso										
Alcance contacto relé de salida (EN/IEC 60947-5-1)	230Vac 5A (AC-13) - 24Vdc 1A (DC-12)									
Temperatura ambiente de funcionamiento:	(-25°C) ÷ (55°C) [-13°F ÷ 131°F]									
Temperatura ambiente de almacenaje:	(-25°C) ÷ (70°C) [-13°F ÷ 158°F]									
Máxima potencia disipada:	6,5 W									

## • Características técnicas

Marcado CE	
<p>Los dispositivos <b>RDBMRCD230 - RDBMRC24</b> son conformes:</p> <ul style="list-style-type: none"> <li>• a la Directiva 2011/65/EU modificada por la directiva 2015/863 (RoHS 2).</li> <li>• Al Reglamento REACH (1907/2006): en la fecha de publicación de este documento, ninguna sustancia insertada en el anexo XIV se encuentra presente en el interior de estos productos.</li> <li>• A la Directiva RAEE (2012/19/UE): directiva europea sobre los residuos de aparatos eléctricos y electrónicos</li> </ul>	
Compatibilidad electromagnética	
Pruebas en conformidad con IEC/EN 60947-2 (annex M)	
Aislamiento (IEC/EN 60947-1)	
Categoría de medida:	III
Grado de contaminación:	2
Rigidez dieléctrica:	Alimentación / Salidas: 2,2kV
Tensión de aislamiento, Ui:	<b>RDBMRCD230:</b> 250V <b>RDBMRCD24:</b> 100V
Mantenimiento del impulso Uimp	<b>RDBMRCD230:</b> 4kV <b>RDBMRCD24:</b> 2,5kV

## • Léxico de las abreviaciones

IΔ	Corriente diferencial instantánea
I <sub>2</sub>	Corriente de intervención diferencial (mA)
I <sub>1</sub>	Valor de intervención diferencial en % de I <sub>2</sub> (Prealarma)
ton <sub>2</sub>	Retraso de intervención (ms/s), (TRIP)
ton <sub>1</sub>	Retraso de intervención (ms/s), (Prealarma)
I <sub>dn</sub>	Modificación del valor de intervención
t	Modificación del retraso de intervención
SEt	Ajustes
On	Ajuste de la contraseña ON / OFF
FAC	Ajustes de fábrica
SYS	No disponible
InF	Versión Firmware / Hardware
HiS	Ver o restablecer la primera alarma almacenada
CLr	Cancelar la cronología reciente
N.C.	Normalmente cerrado (seguridad positiva)
N.O.	Normalmente abierto (seguridad negativa)



A Group brand |  legrand

BTicino S.p.A  
Viale Borri, 231  
21100 Varese (VA) ITALY  
☎: +39 02 44 878.1  
Fax : +39 02 45 86 76 63  
[www.imeitaly.com](http://www.imeitaly.com)

BTicino si riserva in qualsiasi momento il diritto di modificare i contenuti di questo opuscolo e di comunicare, in qualsiasi forma e modalità, i cambiamenti apportati allo stesso.  
BTicino reserves at any time the right to modify the contents of this booklet and to communicate, in any form and modality, the changes brought to the same.