

# CONTO D4-Pt Three-phase energy meter

Manuale d'installazione • *Installation manual* • Manuel d'installation  
• *Installationsanweisungen* • Manual de instalación





### **Sommario**

Pericoli e avvertenze	4
Operazioni preliminari	6
Presentazione	7
Installazione	8
Utilizzo	12
Programmazione	20
Comunicazione	24
Caratteristiche tecniche	26

### **Contents**

<i>Dangers and warnings</i>	4
<i>Preliminary operations</i>	6
<i>Presentation</i>	7
<i>Installation</i>	8
<i>Use</i>	12
<i>Programming</i>	20
<i>Communication</i>	24
<i>Technical characteristics</i>	28

### **Sommaire**

Danger et avertissement	4
Opérations préalables	6
Présentation	7
Installation	8
Utilisation	12
Programmation	20
Communication	24
Caractéristiques techniques	30

### **Summary**

<i>Gefahren und Warnungen</i>	5
<i>Vorarbeiten</i>	6
<i>Presentation</i>	7
<i>Installieren</i>	8
<i>Verwendung</i>	12
<i>Programmierung</i>	20
<i>Kommunikation</i>	25
<i>Technische Daten</i>	32

### **Resumida**

Advertencia	5
Operaciones previas	6
Presentación	7
Instalación	8
Utilización Programación	12
Programación	20
Comunicación	25
Características técnicas	34

## • Pericoli e avvertenze

Questi apparecchi devono essere montati esclusivamente da professionisti.  
Il mancato rispetto delle indicazioni contenute nelle presenti istruzioni solleva il fabbricante da ogni responsabilità.

### **Rischi di folgorazione, ustioni o esplosione**

- L'installazione e la manutenzione di questo apparecchio devono essere effettuate esclusivamente da personale qualificato.
  - Prima di qualsiasi intervento sull'apparecchio, escludere gli ingressi di tensione.
  - Utilizzare sempre un opportuno dispositivo di rilevamento di tensione per confermare l'assenza di tensione.
  - Rimontare tutti i dispositivi, i portelli e i coperchi prima di mettere l'apparecchio sotto tensione.
  - Per alimentare questo apparecchio, utilizzare sempre la tensione nominale indicata.
- In caso di mancato rispetto di queste precauzioni, si potrebbero subire gravi ferite.

### **Rischi di deterioramento dell'apparecchio**

Attenzione a rispettare:

- Una tensione ai morsetti degli ingressi di tensione (V1,V2,V3 e N) secondo i valori indicati nella sezione "Caratteristiche tecniche".
- La corrente ai morsetti L1, L2, L3 secondo i valori indicati nelle sezioni
- La frequenza di rete a 50 o 60 Hz.

## • Dangers and warnings

*This equipment must only be mounted by professionals.  
The manufacturer shall not be held responsible for failure to comply with the instructions in this manual.*

### **Risk of electrocution, burns or explosion**

- *The device must only be installed and serviced by qualified personnel.*
  - *Prior to any work on or in the device, isolate the voltage inputs.*
  - *Always use an appropriate voltage detection device to confirm the absence of voltage.*
  - *Put all mechanisms, door and covers back in place before energising the device.*
  - *Always supply the device with the indicated rated voltage.*
- Failure to take these precautions could cause serious injuries.*

### **Risk of damaging the device**

*Chek the following:*

- *The voltage to the voltage-input terminals, (V1,V2,V3 and N) according to the values indicated in the "Technical characteristics" section.*
- *The current to terminals L1, L2, L3 according to the values indicated in sections*
- *The frequency of the distribution system (50 or 60 Hz).*

## • Danger et avertissement

Le montage de ce produit ne peut être effectué que par des professionnels.  
Le non respect des indications de la présente notice ne saurait engager la responsabilité du constructeur.

### **Risque d'électrocution, de brûlures ou d'explosion**

- L'installation et l'entretien de cet appareil ne doivent être effectués que par du personnel qualifié.
- Avant toute intervention sur l'appareil, coupez les entrées tensions.
- Utilisez toujours un dispositif de détection de tension approprié pour confirmer l'absence de tension.
- Remplacez tous les dispositifs, les portes et les couvercles avant de mettre cet appareil sous tension.
- Utilisez toujours la tension assignée appropriée pour alimenter cet appareil.

Si ces précautions n'étaient pas respectées, cela pourrait entraîner des blessures graves.

### **Risque de détérioration de l'appareil**

Veillez à respecter

- Une tension aux bornes des entrées tensions (V1,V2,V3 et N) selon les valeurs indiquées dans la section "Caractéristiques techniques".
- Le courant aux bornes L1, L2, L3 selon les valeurs indiquées dans les sections
- La plage de fréquence du réseau 50 ou 60 Hz.

## • Gefahren und Warnungen

*Diese Geräte dürfen nur von Fachleuten montiert werden.  
Die Nichtbeachtung der vorliegenden Anweisungen entbindet den Hersteller von jeglicher Haftung.*

### **Stromschlag-, Verbrennungs- und Explosionsgefahr**

- Die Installation und Wartung dürfen nur von qualifizierten Fachleuten vorgenommen werden.
  - Vor jedem Eingriff in das Gerät sind die Spannungseingänge auszuschließen.
  - Verwenden Sie immer ein geeignetes Spannungsmessgerät, um die Spannungsfreiheit zu überprüfen.
  - Alle Geräte, Türen und Abdeckungen wieder montieren, bevor Sie das Gerät unter Spannung setzen.
  - Verwenden Sie immer die angegebene Nennspannung, um das Gerät mit Strom zu versorgen.
- Die Nichtbeachtung dieser Vorsichtsmaßnahmen kann zu schweren Verletzungen führen.*

### **Beschädigungsgefahr des Gerätes**

*Bitte beachten:*

- Eine Spannung an den Klemmen der Spannungseingänge (V1, V2, V3 und N) entsprechend den im Kapitel "Technische Daten" angegebenen Werten.
- Der Strom an den Klemmen L1, L2, L3 gemäß den in den Abschnitten angegebenen Werten
- Netzfrequenz 50/60 Hz

## • Advertencia

El montaje de esto materiales sólo puede ser efectuado por profesionales.  
No respetar las indicaciones del presente manual exime de responsabilidad al fabricante.

### **Riesgo de electrocución, de quemaduras o de explosión**

- La instalación y mantenimiento de este aparato debe ser efectuado por personal cualificado.
- Antes de cualquier intervención en el aparato, cortar sus entradas de tensión.
- Utilizar siempre un dispositivo de detección de tensión apropiado para asegurar la ausencia de tensión.
- Volver a colocar todos los dispositivos, tapas y puertas antes de poner el aparato en tensión.
- Utilizar siempre la tensión asignada apropiada para alimentar el aparato.

No respetar estas precauciones podría entrañar un serio riesgo de producir heridas graves.

### **Riesgo de deterioros de aparato**

Se ha de respetar:

- Una tensión en los bornes de las entradas de tensión (V1, V2, V3 y N) según los valores indicados en la sección "Características técnicas".
- La corriente en los terminales L1, L2, L3 de acuerdo con los valores indicados en las secciones
- La frecuencia de red a 50/60 Hz

## • Operazioni preliminari

Per la sicurezza del personale e del materiale, è indispensabile leggere attentamente il contenuto del presente libretto prima della messa in servizio.

Al momento del ricevimento della scatola contenente il dispositivo, è necessario verificare i seguenti punti:

- lo stato dell'imballo;
- l'assenza di danneggiamenti o rotture dovuti al trasporto;
- la rispondenza tra codice dell'apparecchio e codice ordinato;
- la presenza nell'imballo sia dell'articolo che del foglio istruzioni.

## • Preliminary operations

*For personnel and product safety read the contents of these operating instructions carefully before connecting.*

*Check the following points as soon as you receive the box containing the device:*

- *the packing is in good condition;*
- *the product has not been damaged or broken during transport;*
- *the product reference number conforms to your order;*
- *the package contains both the item and the operating instructions.*

## • Opérations préalables

Pour la sécurité du personnel et du matériel, il est impératif de bien s'imprégner du contenu de cette notice avant la mise en service.

Au moment de la réception du colis contenant le produit, il est nécessaire de vérifier les points suivants :

- l'état de l'emballage ;
- le produit n'a pas eu de dommage pendant le transport ;
- la référence de l'appareil est conforme à votre commande
- l'emballage comprend le produit ;
- une notice d'utilisation.

## • Vorarbeiten

*Für die Sicherheit von Personen und Material ist es unerlässlich, den Inhalt dieser Anleitung vor der Inbetriebnahme aufmerksam zu lesen. Nach Erhalt der Schachtel mit dem Gerät sind die folgenden Punkte zu überprüfen:*

- *Zustand der Verpackung;*
- *Das Fehlen von Beschädigungen oder Bruch durch den Transport;*
- *die Übereinstimmung zwischen Gerätecode und bestelltem Code;*
- *Vorhandensein in der Verpackung sowohl des Artikels als auch der Gebrauchsanweisung.*

## • Operaciones previas

Para la seguridad del personal y del material, será imperativo conocer perfectamente el contenido de este manual antes de su puesta en funcionamiento.

Al recibir el paquete que contiene el producto será necesario verificar los aspectos siguientes:

- estado del embalaje;
- que el producto no se haya dañado durante el transporte;
- que la referencia del aparato esté conforme con su pedido;
- el embalaje incluye el producto;
- el manual de utilización.

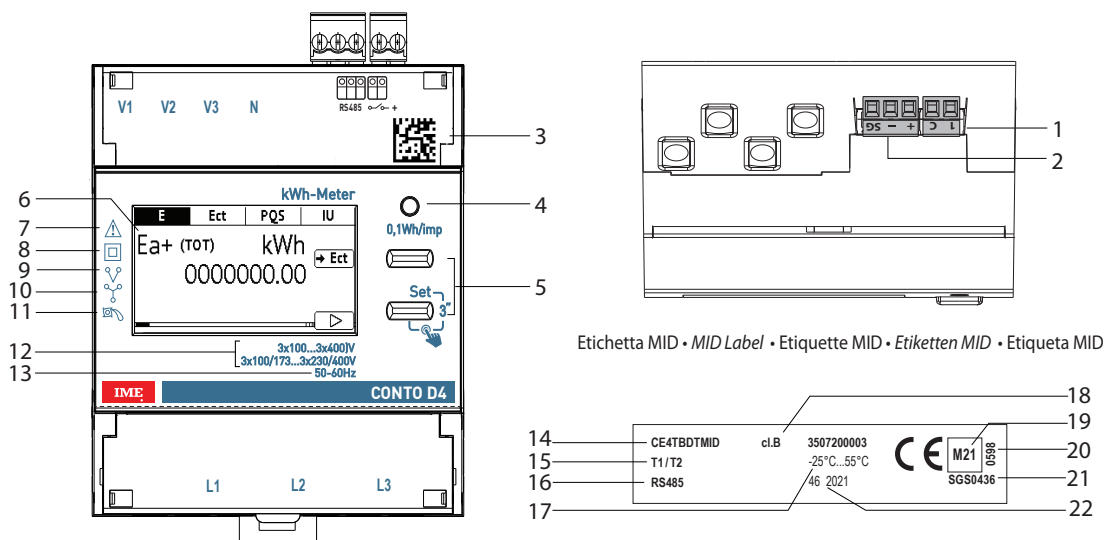

## • Presentazione

1. Morsetto d'ingresso per il conteggio dell'energia su doppia tariffa
2. Morsetti di collegamento uscita impulsi o connessione Modbus/Mbus
3. Datamatrix per tracciabilità prodotto
4. LED metrologico
5. Tastiera composta da 2 pulsanti a doppia funzionalità (visualizzazione/configurazione)
6. Display grafico
7. Consultare manuale d'uso prima dell'installazione
8. Doppio isolamento
9. Inserzione su linea trifase 3 fili
10. Inserzione su linea trifase 4 fili
11. Dispositivo antirotazione (antidecremento)
12. Tensione/Corrente di impiego
13. Frequenza di impiego

### Etichetta MID

14. Codice articolo
15. Doppia tariffa
16. Uscite
17. Temperatura d'impiego
18. Classe di precisione
19. Anno di approvazione
20. Ente certificatore
21. Numero certificazione
22. Settimana e anno di fabbricazione

## • Presentation

1. Input terminal for energy metering on double tariff
2. Pulse output connection terminal or Modbus/Mbus connection
3. Datamatrix for product traceability
4. Metrological LED
5. Keypad made up of 2 double function pushbuttons (display/configurations)
6. Graphic display
7. Consult the user manual before installation
8. Double insulation
9. Connection on 3-wire three-phase line
10. Connection on 4-wire three-phase line
11. Anti-rotation device (anti-decreasing)
12. Operating Voltage/Current
13. Frequency of use

### MID Label

14. Product code
15. Double tariff
16. Outputs
17. Working temperature
18. Accuracy class
19. Year of approval
20. Certifying board
21. Certification NUMBER
22. Manufacturing week and year

## • Présentation

1. Bornier entrée pour le comptage de l'énergie en double tarif
2. Bornier sortie impulsions ou branchement Modbus/Mbus
3. Datamatrix pour traçabilité produit
4. LED métrologique
5. Clavier constitué de 2 boutons à deux fonctions (visualisation/configuration)
6. Écran graphique
7. Consulter le manuel d'utilisation avant de procéder à l'installation.
8. Double isolation
9. Raccordement sur ligne triphasés 3 fils
10. Raccordement sur ligne triphasés 4 fils
11. Dispositif anti-rotation (anti-diminution)
12. Tension/Courant de fonctionnement
13. Fréquence d'utilisation

### Etiquette MID

14. Code du produit
15. Double tarif
16. Sorties
17. Température de fonctionnement
18. Classe de précision
19. Année de certification
20. Organisme de certification
21. Numéro de certification
22. Semaine et année de fabrication

## • Presentation

1. Eingangsklemme zum Zählen von Energie im Doppeltarif
2. Anschlussklemmen Impulsausgang oder Ausgang Modbus/Mbus
3. Datamatrix für die Verfolgbarkeit des Produkts
4. Metrologie LED
5. Tastatur bestehend aus 2 Tasten mit Doppelfunktion (Display/Konfiguration)
6. Graphisches Display
7. Bitte lesen das Handbuch bevor den Einbau
8. Doppelisolierung
9. Drehstromleitung 3 Leiter
10. Drehstromleitung 4 Leiter
11. Verdrehsicherung (Anti-Verringerung)
12. Betriebsspannung/ -strom
13. Häufigkeit der Nutzung

### Etiketten MID

14. Produktcode
15. Doppeltarif
16. Ausgänge
17. Betriebstemperatur
18. Genauigkeitsklasse
19. Anlegungsjahr
20. Zertifizierungsstelle
21. Zertifizierungsnummer
22. Woche und Herstellungsjahr

## • Presentación

1. Borne de entrada para contabilizar la energía en doble tarifa
2. Borne de conexión de la salida de impulsos o Modbus/Mbus
3. Datamatrix para trazabilidad del producto
4. LED metrológico
5. Teclado compuesto por 2 botones con doble función (visualización/configuración)
6. Display gráfico
7. Consultar el manual de uso antes de la instalación
8. Aislamiento doble
9. Inserción en línea trifásica de 3 hilos
10. Inserción en línea trifásica de 4 hilos
11. Dispositivo antirotación (anti decremento)
12. Voltaje/Corriente de funcionamiento
13. Frecuencia de uso

### Etiqueta MID

14. Código de artículo
15. Doble tarifa
16. Salidas
17. Temperatura de uso
18. Clase de precisión
19. Año de certificación
20. Organismo de certificación
21. Número de certificación
22. Semana y año de fabricación

## • Installazione • Installation • Installation • Installieren • Instalación

### • Prescrizioni

- Evitare la vicinanza con sistemi generatori di perturbazioni elettromagnetiche.

### • Recommendations

- Avoid proximity to systems which generate electromagnetic interference.

### • Recommendations

- Éviter la proximité avec des systèmes générateurs de perturbations électromagnétiques

### • Rezepte

- Nähe zu Generatorsystemen vermeiden elektromagnetische Störungen.

### • Prescripciones

- Evitar la proximidad con sistemas que generan interferencias electromagnéticas.

### • Collegamento

Per la coppia di serraggio massima dei morsetti vedere la tabella

### • Connection

For the maximum terminal torque see the table

### • Raccordement

Pour le couple de serrage maximal des bornes voir le tableau

### • Anschluss

Das maximale Anzugsmoment der Klemmen finden Sie in der Tabell

### • Conexión

Para el par de apriete máximo de los bornes, consultar la tabla

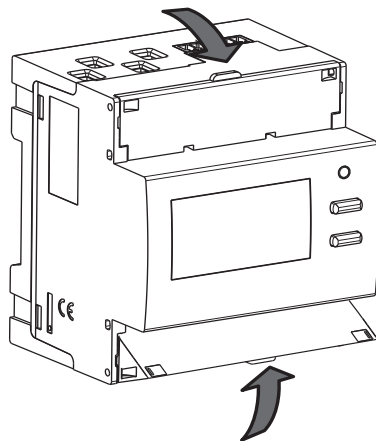

U	3x100/173...3x230/400V 3x100...3x400V		CAT III
CE4TB0PCL1 CE4TBDTCL1 CE4TBMTCL1	I	<b>CT/1A - /5A</b> $I_{min} = 0,01A$ $I_n = 5A$ $I_{max} = 6A$	
	cl.	cl.1 Wh (EN 62053-21) cl.2 varh (EN 62053-23)	
CE4TB0PMID CE4TBDTMID CE4TBMTMID	I	<b>CT/5A</b> $I_{min} = 0,05A$ $I_n = 5A$ $I_{max} = 6A$	
	cl.	cl.B Wh (EN 50470-1,3) cl.2 varh (EN 62053-23)	
	0,1 Wh/imp		
COM		RS485 Modbus	Mbus
 L1-L2-L3 V1-V2-V3		11 mm MAX 1 x 10 mm <sup>2</sup>	Recommended torque 1,6 to 2Nm COMBI PZ2 
		1 x 10 mm <sup>2</sup>	
		1 x 16 mm <sup>2</sup>	
 1 C  RS485 Mbus		8 mm MAX 1 x 1 mm <sup>2</sup>	Recommended torque 0,2Nm 0,5 x 2,5mm 
		1 x 1 mm <sup>2</sup>	
		1 x 1,5 mm <sup>2</sup>	
	(-25°C) - (55°C)		

### • Alimentazione ausiliaria

derivata dalle prese di tensione (Autoalimentato)

### • Auxiliary supply

derived from the voltage terminals (Self-supplied)

### • Alimentation auxiliarire

derivée depuis par les prises de tension (Auto-alimentée)

### • Hilfsversorgung

abgeleitet von den Spannungsanschlüssen (Selbstversorgung)

### • Alimentación auxiliar

derivada de la toma de presión (Autoalimentado)



**• Installazione • Installation • Installation • Installieren • Instalación**

- Marcatura morsettiera e combinazione schemi
- Terminal board marking and diagram combination
- Marquage borniers et combinaison schémas:
- Markierung der Klemmleisten und Kombination der Anschlussbilder
- Marcado de regletas y combinación de esquemas

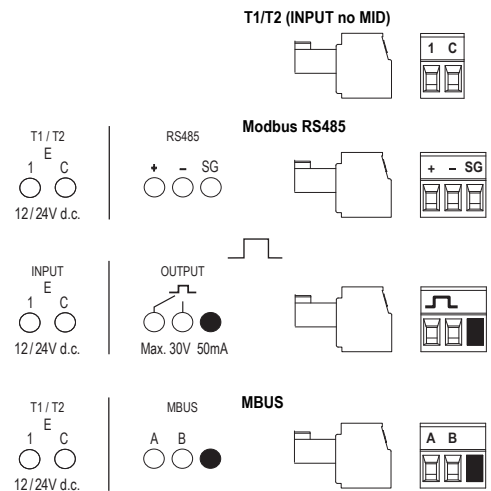

- Schema di collegamento per doppia tariffa • *Wiring diagram for double tariff*
- Schéma de raccordement double tarif • *Schaltplan für Doppeltarif*
- Esquema de conexión para doble tarifa

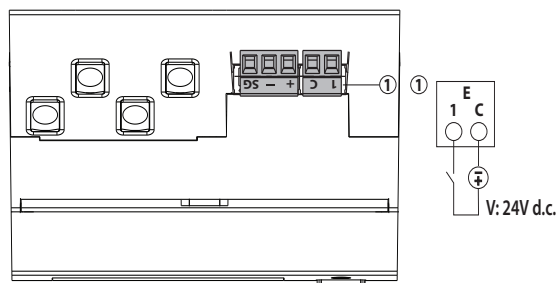

- Collegamento dell'ingresso
- Input connection
- Connexion de l'entrée
- Eingangsverbindung
- Conexión de la entrada

- Nei cablaggi rispettare scrupolosamente lo schema di inserzione; una inesattezza nei collegamenti può pregiudicare il corretto funzionamento o causare danni allo strumento.
- During wiring carefully comply with the connection diagram; a connection error may affect proper operation, or cause damage to the device.
- Veuillez respecter scrupuleusement le schéma de connexion; une erreur de connexion peut nuire au bon fonctionnement, ou causer des dommages à l'appareil.
- Beachten Sie bei der Verdrahtung unbedingt das Anschlussschema; Ungenauigkeiten in den Anschlüssen können zu Fehlbedienungen oder Schäden am Gerät führen.
- En los cableados, se ha de respetar rigurosamente el esquema de inserción; si las conexiones no son precisas, se puede perjudicar el funcionamiento correcto o causar daños al instrumento.

**• Installazione • Installation • Installation • Installieren • Instalación**

- Schema di collegamento • *Wiring diagram* • Schéma de câblage • *Anschlussbilder*
- Esquema de conexión

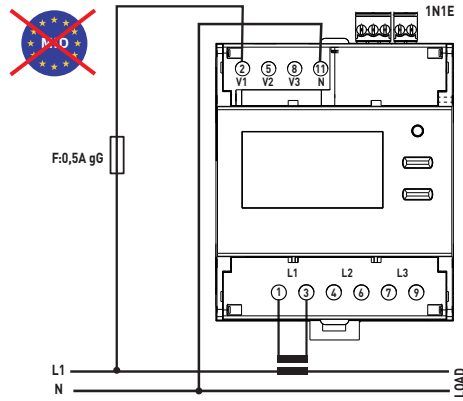

- **Inserzione su VT**
- **Connection on VT**
- **Connexion sur VT**
- **Der Anschluss an VT**
- **Conexión en VT**

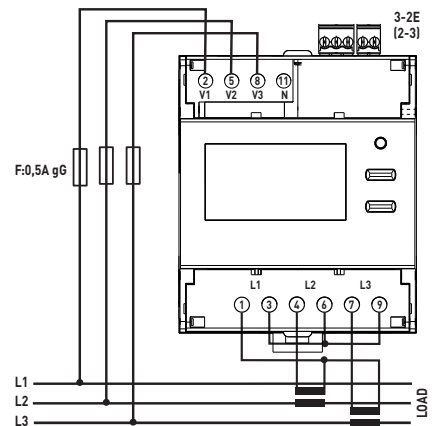
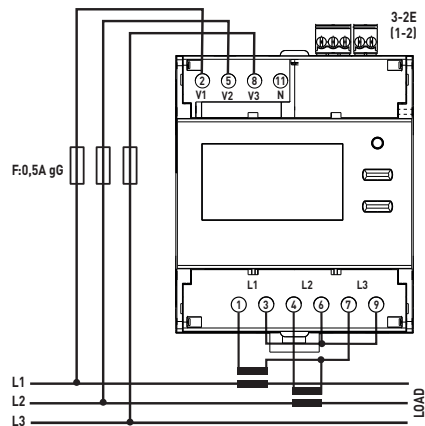
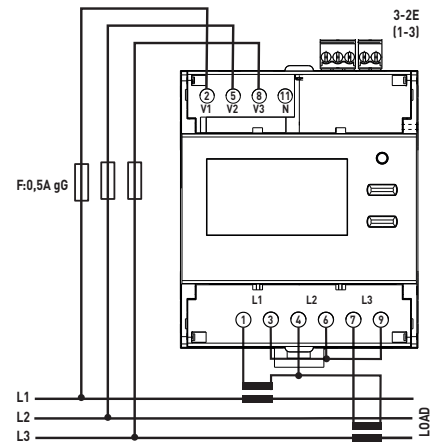
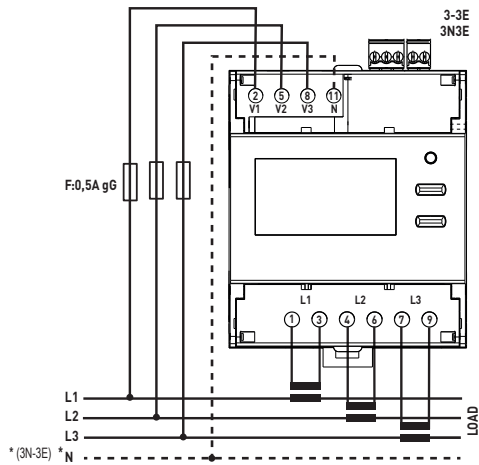
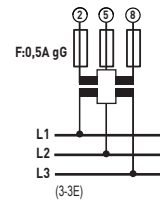
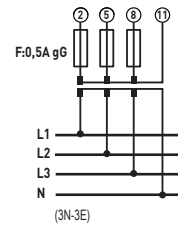

Il collegamento dei TA verso terra dipende dalle normative in vigore nel proprio Paese  
*The connection of the CTs to earth depends on the regulations in force in your country*  
 La connexion des TC à la terre dépend de la réglementation en vigueur dans votre pays  
*Der Anschluss der Stromwandler an die Erde hängt von den in Ihrem Land geltenden Vorschriften ab*  
 La conexión de los TC a tierra depende de la normativa vigente en su país.

• **Installazione • Installation • Installation • Installieren • Instalación**

- **Schema di collegamento RS485 • RS485 wiring diagram • Schéma de branchement RS485**
- **Anschlussbilder RS485 • Esquema de conexión RS485**

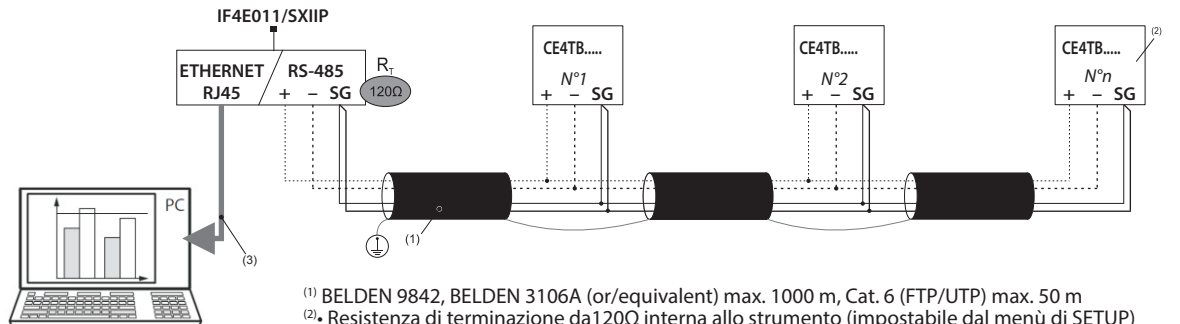

- (1) BELDEN 9842, BELDEN 3106A (or/equivalent) max. 1000 m, Cat. 6 (FTP/UTP) max. 50 m
- (2) Resistenza di terminazione da 120Ω interna allo strumento (impostabile dal menù di SETUP)
  - 120Ω terminating resistor inside the instrument (it can be set in the SETUP menu)
  - Résistance de terminaison de 120 Ω intégrée à l'instrument (réglable dans le menu de RÉGLAGE)
  - 120Ω Abschlusswiderstand intern im Gerät (einstellbar über das SETUP-Menü)
  - Resistencia de terminación de 120Ω interna en el instrumento (ajustable en el menù SETUP)
- (3) Ethernet: Cat. 6 (FTP/UTP)

- **Schema di collegamento RS485 Modbus con Mini Web Server**
- **RS485 Modbus wiring diagram with Mini web Server**
- **Schéma de branchement RS485 Modbus avec Mini Web Server**
- **Anschlussbilder RS485 Modbus Mini Web Server**
- **Esquema de conexión RS485 Modbus con Mini Web Server**

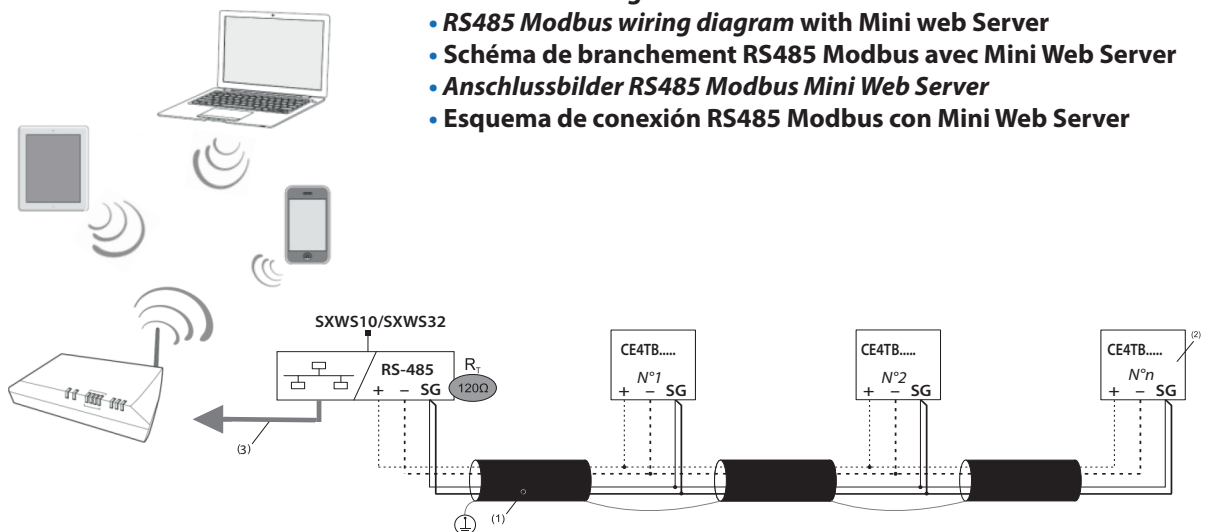

- **Schema di collegamento Mbus**
- **Mbus Modbus wiring diagram**
- **Schéma de branchement Mbus**
- **Anschlussbilder Mbus**
- **Esquema de conexión Mbus**

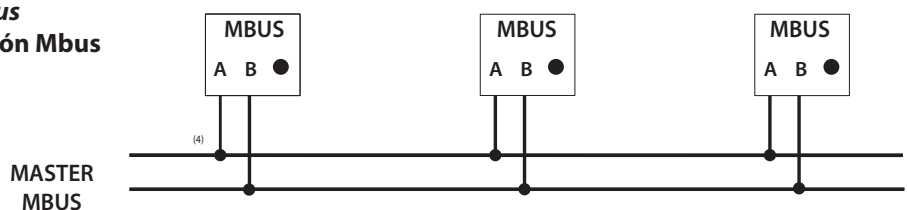

- (4) Collegamenti non polarizzati. Un cavo telefonico standard a due fili (JYStY N°2\*0.8 mm)  
Non-polarized connections. A two-wire standard telephone cable (JYStY N°2\*0.8 mm)  
Connexions non polarisées. Un câble téléphonique standard à deux fils (JYStY N°2\*0.8 mm)  
Nicht polarisierte Verbindungen. Ein zweidriges Standardtelefonkabel (JYStY N°2\*0.8 mm)  
Conexiones no polarizadas. Un cable telefónico estándar de dos hilos (JYStY N°2\*0.8 mm)

## • Utilizzo • Use • Utilisation • Verwendung • Utilización

### • Navigazione pagine di visualizzazione

Il dispositivo è dotato di un display grafico su cui è riportata la funzione eseguita dal tasto corrispondente ed è dipendente dalla pagina visualizzata.

### • Navigation display pages

The device is equipped with a graphic display showing the function performed by the corresponding key and is dependent on the page displayed.

### • Pages d'affichage de navigation

L'appareil est équipé d'un écran graphique indiquant la fonction remplie par la touche correspondante et est dépendant de la page affichée

### • Durchsuchen von Anzeigeseiten

Das Gerät ist mit einem Grafikdisplay ausgestattet, das die von der entsprechenden Taste ausgeführte Funktion anzeigt und ist abhängig von der angezeigten Seite

### • Navegando por páginas de visualización

El dispositivo está equipado con una pantalla gráfica que muestra la función realizada por la tecla correspondiente y está depende de la página mostrada

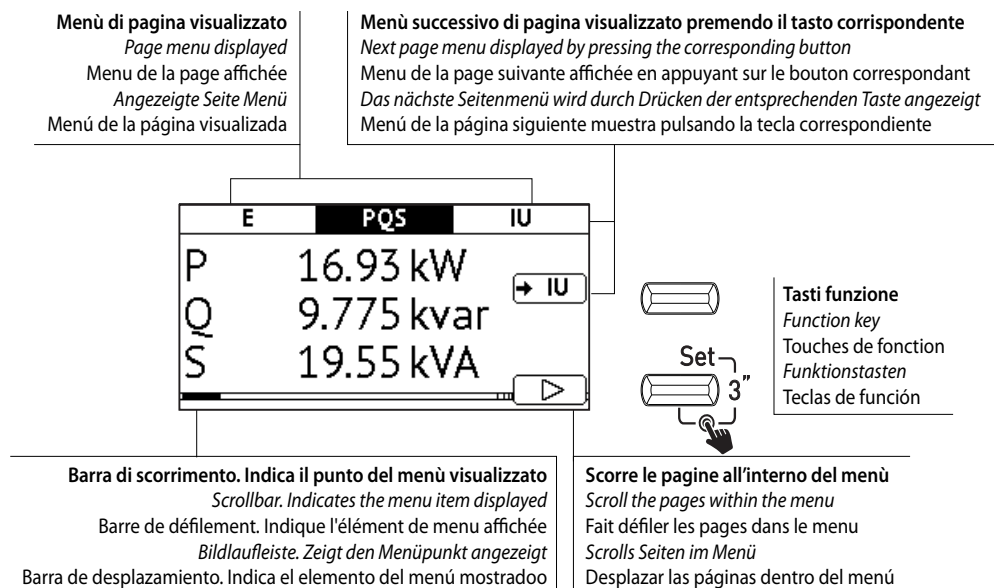

**Energia diretta**  
 Direct energy  
 Energie direct  
 Direkte Energie  
 Energía directa

**Energia Indiretta**  
 Indirect energy  
 Energie indirect  
 Indirekte Energie  
 Energía indirecta

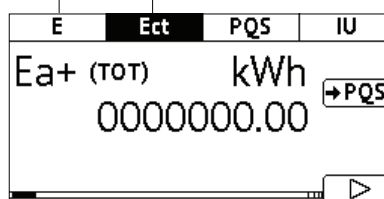

• Utilizzo • Use • Utilisation • Verwendung • Utilización

• Energie dirette • Direct energies • Energies directes • Direkte energie • Energías directas

CE4TBDTCL1  
CE4TBMTCCL1  
CE4TB0PCL1

Su tutti i modelli  
On all codes  
Sur tous les codes  
Auf allen Codes  
En todos los codigos

Ect	PQS	IU
Ea+ (TOT)	kWh	→PQS
0000000.00		
Ea- (TOT)	kWh	→PQS
0000000.00		
Er+ (TOT)	kvarh	→PQS
0000000.00		
Er- (TOT)	kvarh	→PQS
0000000.00		

**Energia attiva totale positiva**

Total positive active energy  
Energie active positive totale  
Total positive Wirkenergie  
Energía activa positiva total

**Energia attiva totale negativa**

Total negative active energy  
Energie active négative totale  
Total negative Wirkenergie  
Energía activa negativa total

**Energia reattiva totale positiva**

Total positive reactive energy  
Energie réactive positive totale  
Total positive Blindenergie  
Energía reactiva positiva total

**Energia reattiva totale negativa**

Total negative reactive energy  
Energie réactive négative totale  
Total negative Blindenergie  
Energía reactiva negativa total

Ect	PQS	IU
Ea+ kWh	→PQS	
T <sub>1</sub> 0000000.00		
T <sub>2</sub> 0000000.00		
Ea- kWh	→PQS	
T <sub>1</sub> 0000000.00		
T <sub>2</sub> 0000000.00		
Er+ kvarh	→PQS	
T <sub>1</sub> 0000000.00		
T <sub>2</sub> 0000000.00		
Er- kvarh	→PQS	
T <sub>1</sub> 0000000.00		
T <sub>2</sub> 0000000.00		

\*\* CE4TBDTCL1  
\*\* CE4TBMTCCL1

**Energia attiva totale positiva T1/T2**

Total positive active energy T1/T2  
Energie active positive totale T1/T2  
Total positive Wirkenergie T1/T2  
Energía activa positiva total T1/T2

**Energia attiva totale negativa T1/T2**

Total negative active energy T1/T2  
Energie active négative totale T1/T2  
Total negative Wirkenergie T1/T2  
Energía activa negativa total T1/T2

**Energia reattiva totale positiva T1/T2**

Total positive reactive energy T1/T2  
Energie réactive positive totale T1/T2  
Total positive Blindenergie T1/T2  
Energía reactiva positiva total T1/T2

**Energia reattiva totale negativa T1/T2**

Total negative reactive energy T1/T2  
Energie réactive négative totale T1/T2  
Total negative Blindenergie T1/T2  
Energía reactiva negativa total T1/T2

Su tutti i modelli  
On all codes  
Sur tous les codes  
Auf allen Codes  
En todos los codigos

Ect	PQS	IU
Ea+ (Par)	kWh	→PQS
0000000.00		
Ea- (Par)	kWh	→PQS
0000000.00		
Er+ (Par)	kvarh	→PQS
0000000.00		
Er- (Par)	kvarh	→PQS
0000000.00		

**Energia attiva parziale positiva**

Partial positive active energy  
Energie active positive partielle  
Positive teilweise Wirkenergie  
Energía activa parcial positiva

**Energia attiva parziale negativa**

Partial negative active energy  
Energie active partielle negative  
Negative teilweise Wirkenergie  
Energía activa parcial negativa

**Energia reattiva parziale positiva**

Positive partial reactive energy  
Energie réactive partielle positive  
Positive teilweise Blindenergie  
Energía reactiva parcial positiva

**Energia reattiva parziale negativa**

Partial negative reactive energy  
Energie réactive partielle négative  
Negative teilweise Blindenergie  
Energía reactiva parcial negativa

CE4TB0PCL1  
\* CE4TBDTCL1  
\* CE4TBMTCCL1

Ect	PQS	IU
Pulse In	Wh	→PQS
0000000.00		

**Contatore di impulsi**

Pulse counter  
Compteur d'impulsions  
Impulszähler  
Contador de pulsos

## • Utilizzo • Use • Utilisation • Verwendung • Utilización

- Energie dirette/indirette • Direct/indirect energies • Energies directes/indirectes
- Direkte/indirekte energien • Energías directas/Indirectas

CE4TBDTMID  
CE4TBM TMID  
CE4TB0PMID



Su tutti i modelli  
On all codes  
Sur tous les codes  
Auf allen Codes  
En todos los codigos

CE4TBDTMID  
CE4TBM TMID

Su tutti i modelli  
On all codes  
Sur tous les codes  
Auf allen Codes  
En todos los codigos

CE4TB0PMID

E	Ect	PQS	IU
Ea+ (TOT)		kWh	→ Ect
		0000000.00	
Ea- (TOT)		kWh	→ Ect
		0000000.00	
Er+ (TOT)		kvarh	→ Ect
		0000000.00	
Er- (TOT)		kvarh	→ Ect
		0000000.00	
Ea+ (T1/T2)		kWh	→ Ect
T1 ON		0000000.00	
T2		0000000.00	
Ea- (T1/T2)		kWh	→ Ect
T1 ON		0000000.00	
T2		0000000.00	
Er+ (T1/T2)		kvarh	→ Ect
T1 ON		0000000.00	
T2		0000000.00	
Er- (T1/T2)		kvarh	→ Ect
T1 ON		0000000.00	
T2		0000000.00	
Ea+ (Par)		kWh	→ Ect
		0000000.00	
			3" Rst
Ea- (Par)		kWh	→ Ect
		0000000.00	
			3" Rst
Er+ (Par)		kvarh	→ Ect
		0000000.00	
			3" Rst
Er- (Par)		kvarh	→ Ect
		0000000.00	
			3" Rst
Pulse In		Wh	→ Ect
		0000000.00	
			3" Rst

### Energia attiva totale positiva

Total positive active energy  
Energie active positive totale  
Total positive Wirkenergie  
Energia activa positiva total

### Energia attiva totale negativa

Total negative active energy  
Energie active négative totale  
Total negative Wirkenergie  
Energia activa negativa total

### Energia reattiva totale positiva

Total positive reactive energy  
Energie réactive positive totale  
Total positive Blindenergie  
Energia reactiva positiva total

### Energia reattiva totale negativa

Total negative reactive energy  
Energie réactive négative totale  
Total negative Blindenergie  
Energia reactiva negativa total

### Energia attiva totale positiva T1/ T2

Total positive active energy T1/T2  
Energie active positive totale T1/T2  
Total positive Wirkenergie T1/T2  
Energia activa positiva total T1/T2

### Energia attiva totale negativa T1/ T2

Total negative active energy T1/T2  
Energie active négative totale T1/T2  
Total negative Wirkenergie T1/T2  
Energia activa negativa total T1/T2

### Energia reattiva totale positiva T1/ T2

Total positive reactive energy T1/T2  
Energie réactive positive totale T1/T2  
Total positive Blindenergie T1/T2  
Energia reactiva positiva total T1/T2

### Energia reattiva totale negativa T1/ T2

Total negative reactive energy T1/T2  
Energie réactive négative totale T1/T2  
Total negative Blindenergie T1/T2  
Energia reactiva negativa total T1/T2

### Energia attiva parziale positiva

Partial positive active energy  
Energie active positive partielle  
Positive teilweise Wirkenergie  
Energia activa parcial positiva

### Energia attiva parziale negativa

Positive partial active energy  
Energie active partielle positive  
Positive teilweise Wirkenergie  
Energia activa parcial positiva

### Energia reattiva parziale positiva

Positive partial reactive energy  
Energie réactive partielle positive  
Positive teilweise Blindenergie  
Energia reactiva parcial positiva

### Energia reattiva parziale negativa

Partial negative reactive energy  
Energie réactive partielle négative  
Negative teilweise Blindenergie  
Energia reactiva parcial negativa

### Contatore di impulsi

Pulse counter  
Compteur d'impulsions  
Impulszähler  
Contador de pulsos

• Utilizzo • Use • Utilisation • Verwendung • Utilización

• Potenze • Powers • Puissance • Leistung • Potestades

CE4TBDTCL1  
CE4TBMTCCL1  
CE4TB0PCL1

Su tutti i modelli  
On all codes  
Sur tous les codes  
Auf allen Codes  
En todos los codigos

	Ect	PQS	IU
P	0.000 kW		→ IU
Q	0.000 kvar		
S	0.000 kVA		
P <sub>1</sub>	0.000 kW		→ IU
P <sub>2</sub>	0.000 kW		
P <sub>3</sub>	0.000 kW		
Q <sub>1</sub>	0.000 kvar		→ IU
Q <sub>2</sub>	0.000 kvar		
Q <sub>3</sub>	0.000 kvar		
S <sub>1</sub>	0.000 kVA		→ IU
S <sub>2</sub>	0.000 kVA		
S <sub>3</sub>	0.000 kVA		
PF	0.000		→ IU
MD	5 min		
	0.000 kW		
** CE4TBDTCL1 ** CE4TBMTCCL1			
PMD	0.000 kW		→ IU
T <sub>1</sub>	0.000 kW		→ IU
T <sub>2</sub>	0.000 kW		→ IU
PMD	0.000 kW		→ IU

**Potenze trifase**

Three-phase powers  
Puissance triphasés  
Dreiphasige Leistungen  
Potencias trifásicas

**Potenze attive di fase (solo 3N3E)**

Phase active power (only 3N3E)  
Puissance active par phase (seul 3N3E)  
Wirkleistungen je Phase (nur 3N3E)  
Fases de potencias activas (únicamente 3N3E)

**Potenze reattive di fase (solo 3N3E)**

Phase reactive power (only 3N3E)  
Puissance reactive par phase (seul 3N3E)  
Blindleistungen je Phase (nur 3N3E)  
Fases de potencias reactivas (únicamente 3N3E)

**Potenze apparenti di fase (solo 3N3E)**

Phase apparent power (only 3N3E)  
Puissance apparente par phase (seul 3N3E)  
Scheinleistungen je Phase (nur 3N3E)  
Fases de potencia aparentes (únicamente 3N3E)

**Fattore di potenza trifase (Ind./Cap.)**

Three-phase power factor (Ind./Cap.)  
Facteur de puissance triphasés (Ind./Cap.)  
Dreiphasige Leistungsfaktor (Ind./Kap.)  
Factor de potencia trifásicas (Ind./Cap.)

**Potenza media / tempo integrazione**

Power demand / tempo integrazione  
Puissance moyenne / temps d'intégration  
Mittlerer Leistung / Integrationszeit  
Potencia media / tiempo de integración

**Picco di potenza media T1**

Power Max. demand T1  
Pointe de puissance moyenne T1  
Mittlere Leistungsspitze T1  
Pico de potencia promedio T1

**Picco di potenza media T2**

Power Max. demand T2  
Pointe de puissance moyenne T2  
Mittlere Leistungsspitze T2  
Pico de potencia promedio T2

**Picco di potenza media**

Power Max. demand  
Pointe de puissance moyenne  
Mittlere Leistungsspitze  
Pico de potencia promedio

**Nota** \* Pagina visualizzabile solo se la configurazione ingresso è stata programmata come "Input mode Pulse"

\*\* Pagina visualizzabile solo se la configurazione ingresso è stata programmata come "Input mode Tariff"

**Nota** \* Page viewable only if the input configuration has been programmed as "Input mode Pulse"

\*\* Page viewable only if the input configuration has been programmed as "Input mode Tariff"

**Nota** \* Page visible uniquement si la configuration d'entrée a été programmée comme "Input mode Pulse"

\*\* Page visible uniquement si la configuration d'entrée a été programmée comme "Input mode Tariff"

**Nota** \* Seite nur sichtbar, wenn die Eingangskonfiguration als "Input mode Pulse"

\*\* Seite nur sichtbar, wenn die Eingangskonfiguration als "Input mode Tariff"

**Nota** \* Página visible solo si la configuración de entrada se ha programado como "Input mode Pulse"

\*\* Página visible solo si la configuración de entrada se ha programado como "Input mode Tariff"

## • Utilizzo • Use • Utilisation • Verwendung • Utilización

### • Potenze • Powers • Puissance • Leistung • Potestades

CE4TBDTMID  
CE4TBMTMID  
CE4TB0PMID



Su tutti i modelli  
On all codes  
Sur tous les codes  
Auf allen Codes  
En todos los codigos

	E	Ect	PQS	IU
P				0.000 kW
Q				0.000 kvar
S				0.000 kVA
P <sub>1</sub>				0.000 kW
P <sub>2</sub>				0.000 kW
P <sub>3</sub>				0.000 kW
Q <sub>1</sub>				0.000 kvar
Q <sub>2</sub>				0.000 kvar
Q <sub>3</sub>				0.000 kvar
S <sub>1</sub>				0.000 kVA
S <sub>2</sub>				0.000 kVA
S <sub>3</sub>				0.000 kVA
PF				0.000
MD				5 min 0.000 kW

	E	Ect	PQS	IU
PF				0.000

#### Potenze trifase

Three-phase powers  
Puissance triphasés  
Dreiphasige Leistungen  
Potencias trifásicas

#### Potenze attive di fase (solo 3N3E)

Phase active power (only 3N3E)  
Puissance active par phase (seul 3N3E)  
Wirkleistungen je Phase (nur 3N3E)  
Fases de potencias activas (únicamente 3N3E)

#### Potenze reattive di fase (solo 3N3E)

Phase reactive power (only 3N3E)  
Puissance reactive par phase (seul 3N3E)  
Blindleistungen je Phase (nur 3N3E)  
Fases de potencias reactivas (únicamente 3N3E)

#### Potenze apparenti di fase (solo 3N3E)

Phase apparent power (only 3N3E)  
Puissance apparente par phase (seul 3N3E)  
Scheinleistungen je Phase (nur 3N3E)  
Fases de potencia aparentes (únicamente 3N3E)

#### Fattore di potenza trifase (Ind./Cap.)

Three-phase power factor (Ind./Cap.)  
Facteur de puissance triphasés (Ind./Cap.)  
Dreiphasige Leistungsfaktor (Ind./Kap.)  
Factor de potencia trifásicas (Ind./Cap.)

#### Potenza media / tempo integrazione

Power demand / tempo integrazione  
Puissance moyenne / temps d'intégration  
Mittlere Leistung / Integrationszeit  
Potencia media / tiempo de integración

CE4TBDTMID  
CE4TBMTMID

	E	Ect	PQS	IU
PMD				0.000 kW
T <sub>1</sub>				0.000 kW
PMD				0.000 kW
T <sub>2</sub>				0.000 kW

#### Picco di potenza media T1

Power Max. demand T1  
Pointe de puissance moyenne T1  
Mittlere Leistungsspitze T1  
Pico de potencia promedio T1

#### Picco di potenza media T2

Power Max. demand T2  
Pointe de puissance moyenne T2  
Mittlere Leistungsspitze T2  
Pico de potencia promedio T2

#### Picco di potenza media

Power Max. demand  
Pointe de puissance moyenne  
Mittlere Leistungsspitze  
Pico de potencia promedio

CE4TB0PMID

	E	Ect	PQS	IU
PMD				0.000 kW

- Azzeramento
- Reset
- Remise à zéro
- Rücksetzen
- Volver a cero

**Nota:** L'azzeramento è possibile solo nelle pagine dove appare la dicitura "3" Rst

**Nota:** Reset is possible only in the pages where "3" Rst appears

**Nota:** Mise à zéro est possible que sur les pages où apparaît le libellé "3" Rst

**Nota:** Ein Zurücksetzen ist nur auf den Seiten möglich, auf denen "3" Rst zuerst angezeigt wird

**Nota:** Reducción a cero es posible sólo en las páginas en las que aparece el texto "Rst 3"

	E	PQS	IU
Hours			h.m
TOT			19999.53

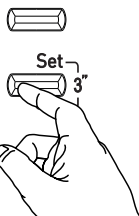

x1  
3" sec.  
Reset

	E	PQS	IU
Hours			h.m
TOT			00000.00



• Utilizzo • Use • Utilisation • Verwendung • Utilización

- Tensioni e correnti • Voltages and currents • Tensions et courants • Spannungen und Ströme
- Tensiones y corrientes

CE4TBDTCL1  
CE4TBMTCCL1  
CE4TB0PCL1

Su tutti i modelli  
On all codes  
Sur tous les codes  
Auf allen Codes  
En todos los codigos

Ect	PQS	IU
U <sub>1</sub>	230.0V	→ Ect
I <sub>1</sub>	0.000A	
▶		
Ect	PQS	IU
U <sub>1</sub>	230.0V	→ Ect
U <sub>2</sub>	230.0V	
U <sub>3</sub>	230.0V	
▶		
Ect	PQS	IU
U <sub>12</sub>	400.0V	→ Ect
U <sub>23</sub>	400.0V	
U <sub>31</sub>	400.0V	
▶		
Ect	PQS	IU
I <sub>1</sub>	0.000A	→ Ect
I <sub>2</sub>	0.000A	
I <sub>3</sub>	0.000A	
▶		
Ect	PQS	IU
f	50.01 Hz	→ Ect
▶		
Ect	PQS	IU
Φ(U <sub>1</sub> -U <sub>2</sub> )	0.0°	→ Ect
Φ(U <sub>2</sub> -U <sub>3</sub> )	0.0°	
Φ(U <sub>3</sub> -U <sub>1</sub> )	0.0°	
▶		
Ect	PQS	IU
Φ(U <sub>12</sub> -U <sub>23</sub> )	0.0°	→ Ect
Φ(U <sub>23</sub> -U <sub>31</sub> )	0.0°	
Φ(U <sub>31</sub> -U <sub>12</sub> )	0.0°	
▶		
Ect	PQS	IU
Φ(I <sub>1</sub> -I <sub>2</sub> )	0.0°	→ Ect
Φ(I <sub>2</sub> -I <sub>3</sub> )	0.0°	
Φ(I <sub>3</sub> -I <sub>1</sub> )	0.0°	
▶		
Ect	PQS	IU
Φ(U <sub>1</sub> -I <sub>1</sub> )	0.0°	→ Ect
Φ(U <sub>2</sub> -I <sub>2</sub> )	0.0°	
Φ(U <sub>3</sub> -I <sub>3</sub> )	0.0°	
▶		
Ect	PQS	IU
Φ(U <sub>1</sub> -I <sub>1</sub> )	0.0°	→ Ect
▶		
Ect	PQS	IU
Hours	h.m	→ Ect
TOT	00000.00	
▶		
3" Rst		

Mbus/Modbus	Ect	PQS	IU
Hours	h.m		→ Ect
T <sub>1</sub>	00000.00		
T <sub>2</sub>	00000.00		

\*\* CE4TBDTCL1  
\*\* CE4TBMTCCL1

**Tensione e corrente di fase** (solo 1N1E)

Phase voltage and current (only 1N1E)  
Tension et courant simple (seul 1N1E)  
Phasenspannung und -strom (nur 1N1E)  
Tensione y corriente de fase (únicamente 1N1E)

**Tensioni di fase** (solo 3N3E)

Phase voltages (only 3N3E)  
Tension simple (seul 3N3E)  
Phasenspannungen (nur 3N3E)  
Tensiones de fase (únicamente 3N3E)

**Tensioni concatenate** (solo 3N3E; 3-3E; 3-2E)

Linked voltages (only 3N3E; 3-3E; 3-2E)  
Tensions composée (seul 3N3E; 3-3E; 3-2E)  
Verketteten Spannungen (nur 3N3E; 3-3E; 3-2E)  
Tensiones concatenadas (únicamente 3N3E; 3-3E; 3-2E)

**Correnti di fase** (solo 3N3E; 3-3E; 3-2E)

Phase currents (only 3N3E; 3-3E; 3-2E)  
Courant par phase (seul 3N3E; 3-3E; 3-2E)  
Phasenströme (nur 3N3E; 3-3E; 3-2E)  
Corrientes de fase (únicamente 3N3E; 3-3E; 3-2E)

**Frequenza di rete**

Network frequency  
Fréquence du réseau  
Netzwerkfrequenz  
Frecuencia de red

**Sfasamento fra le tensioni di fase** (solo 3N3E)

Phase shift between the phase voltages (only 3N3E)  
Décalage de phase entre les tensions de phase (seul 3N3E)  
Phasenverschiebung zwischen den Phasenspannungen (nur 3N3E)  
Desplazamiento de fase entre las tensiones de fase (únicamente 3N3E)

**Sfasamento fra le tensioni di fase** (solo 3-3E; 3-2E)

Phase shift between the phase voltages (only 3-3E; 3-2E)  
Décalage de phase entre les tensions de phase (seul 3-3E; 3-2E)  
Phasenverschiebung zwischen den Phasenspannungen (nur 3-3E; 3-2E)  
Desplazamiento de fase entre las tensiones de fase (únicamente 3-3E; 3-2E)

**Sfasamento fra le correnti di fase** (solo 3N3E; 3-3E; 3-2E)

Phase shift between the phase currents (only 3N3E; 3-3E; 3-2E)  
Décalage de phase entre les courants de phase (seul 3N3E; 3-3E; 3-2E)  
Phasenverschiebung zwischen den Phasenströmen (nur 3N3E; 3-3E; 3-2E)  
Desplazamiento de fase entre las corrientes de fase (únicamente 3N3E; 3-3E; 3-2E)

**Sfasamento fra tensioni e correnti** (solo 3N3E; 3-3E; 3-2E)

Phase shift between voltages and currents (only 3N3E; 3-3E; 3-2E)  
Déphasage entre tensions et courants (seul 3N3E; 3-3E; 3-2E)  
Phasenverschiebung zwischen Spannungen und Strömen (nur 3N3E; 3-3E; 3-2E)  
Desplazamiento de fase entre tensiones y corrientes (únicamente 3N3E; 3-3E; 3-2E)

**Sfasamento fra tensioni e correnti** (solo 1N1E)

Phase shift between voltages and currents (only 1N1E)  
Déphasage entre tensions et courants (seul 1N1E)  
Phasenverschiebung zwischen Spannungen und Strömen (nur 1N1E)  
Desplazamiento de fase entre tensiones y corrientes (únicamente 1N1E)

**Contatore orario**

Hour counter  
Compteur d'heures  
Zeitähler  
Contador de horas

**Contatore orario T1/ T2**

Hour counter T1/ T2  
Compteur d'heures T1/ T2  
Zeitähler T1/ T2  
Contador de horas T1/ T2

## • Utilizzo • Use • Utilisation • Verwendung • Utilización

- Tensioni e correnti • Voltages and currents • Tensions et courants • Spannungen und Ströme
- Tensiones y corrientes

CE4TBDTMID  
CE4TBMTMID  
CE4TB0PMID



Su tutti i modelli  
On all codes  
Sur tous les codes  
Auf allen Codes  
En todos los codigos

CE4TBDTMID  
CE4TBMTMID

	E	Ect	PQS	IU
U <sub>1</sub>	230.0V			→ E
U <sub>2</sub>	230.0V			→ E
U <sub>3</sub>	230.0V			→ E
U <sub>12</sub>	400.0V			→ E
U <sub>23</sub>	400.0V			→ E
U <sub>31</sub>	400.0V			→ E
I <sub>1</sub>	0.000 A			→ E
I <sub>2</sub>	0.000 A			→ E
I <sub>3</sub>	0.000 A			→ E
f	50.00 Hz			→ E
Φ(U <sub>1</sub> -U <sub>2</sub> )	0.0°			→ E
Φ(U <sub>2</sub> -U <sub>3</sub> )	0.0°			→ E
Φ(U <sub>3</sub> -U <sub>1</sub> )	0.0°			→ E
Φ(U <sub>12</sub> -U <sub>23</sub> )	0.0°			→ E
Φ(U <sub>23</sub> -U <sub>31</sub> )	0.0°			→ E
Φ(U <sub>31</sub> -U <sub>12</sub> )	0.0°			→ E
Φ(I <sub>1</sub> -I <sub>2</sub> )	0.0°			→ E
Φ(I <sub>2</sub> -I <sub>3</sub> )	0.0°			→ E
Φ(I <sub>3</sub> -I <sub>1</sub> )	0.0°			→ E
Φ(U <sub>1</sub> -I <sub>1</sub> )	0.0°			→ E
Φ(U <sub>2</sub> -I <sub>2</sub> )	0.0°			→ E
Φ(U <sub>3</sub> -I <sub>3</sub> )	0.0°			→ E
Hours	h.m			→ E
TOT	00000.00			→ E
Hours	h.m			→ E
T <sub>1</sub> ON	00000.00			→ E
T <sub>2</sub>	00000.00			→ E

### Tensioni di fase (solo 3N3E)

Phase voltages (only 3N3E)  
Tension simple (seul 3N3E)  
Phasenspannungen (nur 3N3E)  
Tensiones de fase (únicamente 3N3E)

### Tensioni concatenate (solo 3N3E; 3-3E; 3-2E)

Linked voltages (only 3N3E; 3-3E; 3-2E)  
Tensions composée (seul 3N3E; 3-3E; 3-2E)  
Verketteten Spannungen (nur 3N3E; 3-3E; 3-2E)  
Tensiones concatenadas (únicamente 3N3E; 3-3E; 3-2E)

### Correnti di fase (solo 3N3E; 3-3E; 3-2E)

Phase currents (only 3N3E; 3-3E; 3-2E)  
Courant par phase (seul 3N3E; 3-3E; 3-2E)  
Phasenströme (nur 3N3E; 3-3E; 3-2E)  
Corrientes de fase (únicamente 3N3E; 3-3E; 3-2E)

### Frequenza di rete

Network frequency  
Fréquence du réseau  
Netzwerkfrequenz  
Frecuencia de red

### Sfasamento fra le tensioni di fase (solo 3N3E)

Phase shift between the phase voltages (only 3N3E)  
Décalage de phase entre les tensions de phase (seul 3N3E)  
Phasenverschiebung zwischen den Phasenspannungen (nur 3N3E)  
Desplazamiento de fase entre las tensiones de fase (únicamente 3N3E)

### Sfasamento fra le tensioni di fase (solo 3-3E; 3-2E)

Phase shift between the phase voltages (only 3-3E; 3-2E)  
Décalage de phase entre les tensions de phase (seul 3-3E; 3-2E)  
Phasenverschiebung zwischen den Phasenspannungen (nur 3-3E; 3-2E)  
Desplazamiento de fase entre las tensiones de fase (únicamente 3-3E; 3-2E)

### Sfasamento fra le correnti di fase (solo 3N3E; 3-3E; 3-2E)

Phase shift between the phase currents (only 3N3E; 3-3E; 3-2E)  
Décalage de phase entre les courants de phase (seul 3N3E; 3-3E; 3-2E)  
Phasenverschiebung zwischen den Phasenströmen (nur 3N3E; 3-3E; 3-2E)  
Desplazamiento de fase entre las corrientes de fase (únicamente 3N3E; 3-3E; 3-2E)

### Sfasamento fra tensioni e correnti (solo 3N3E; 3-3E; 3-2E)

Phase shift between voltages and currents (only 3N3E; 3-3E; 3-2E)  
Déphasage entre tensions et courants (seul 3N3E; 3-3E; 3-2E)  
Phasenverschiebung zwischen Spannungen und Strömen (nur 3N3E; 3-3E; 3-2E)  
Desplazamiento de fase entre tensiones y corrientes (únicamente 3N3E; 3-3E; 3-2E)

### Contatore orario

Hour counter  
Compteur d'heures  
Zeitähler  
Contador de horas

### Contatore orario T1/T2

Hour counter T1/T2  
Compteur d'heures T1/T2  
Zeitähler T1/T2  
Contador de horas T1/T2

• Programmazione • Programming • Programmation • Programmierung  
• Programación

Modbus  
CE4TBDTCL1  
CE4TBDTMD

MID / no MID	SETUP Address 001 [SET]	<b>Indirizzo RS485</b> RS485 address Adresse RS485 Adresse RS485 Dirección RS485
	SETUP Baudrate 19.2 kbit/s [SET]	<b>Velocità di comunicazione</b> Communication speed Vitesse de communication Kommunikationsgeschwindigkeit Velocidad de comunicación
	SETUP Parity Even [SET]	<b>Bit di parità</b> Parity bit Bit de parité Paritätsbit Bit de paridad
	SETUP RX time 15 ms [SET]	<b>Tempo di risposta a interrogazione</b> Required response time to request Temps de réponse à la requête Antwortzeit auf Abfrage Tiempo de respuesta a la consulta
	SETUP Termination None [SET]	<b>Resistenza di terminazione</b> Termination resistance Résistance de terminaison Kündigungswiderstand Resistencia de terminación
	SETUP Protocol Standard [SET]	<b>Tipo di protocollo</b> Protocol type Type de protocole Protokolltyp Tipo de protocolo
	SETUP Int. time (MD) 15 Minutes [SET]	<b>Tempo di integrazione potenza media</b> Tempo di integrazione potenza media Temps d'intégration moyen Durchschnittliche Power-Integrationszeit Tiempo medio de integración de potencia
	SETUP Run hours thr 00.00% [SET]	<b>Avvio conteggio</b> Start counting Commencez comptage Beginnen Sie zu zählen Empezar a contar
	SETUP KTA 0001 [SET]	<b>Rapporto TA esterni</b> External CT ratio Rapport des TC externes Verhältnis des externen CT Relación de CT externa
	SETUP KTV 001.00 [SET]	<b>Rapporto TV esterni</b> External VT ratio Rapport des TP externes Verhältnis des externen VT Relación de VT externa
	SETUP Wiring 3n-3E [SET]	<b>Tipo di connessione</b> Connection type Type de connexion Verbindungstyp Tipo de conexión
	SETUP Input mode Pulse [SET]	<b>Configurazione Ingresso</b> Input configuration Configuration d'entrée Eingangskonfiguration Configuración de entrada
	no MID	SETUP Input pulse unit Wh [SET]
no MID	SETUP In. pulse weight 000.00 Wh [SET]	<b>Peso impulsi in ingresso</b> Input pulse weight Poids d'impulsion d'entrée Eingangsimpulsgewicht Peso de pulso de entrada
MID / no MID	SETUP Change psw 0000 [SET]	<b>Modifica Password</b> Change Password Changer le mot de passe Kennwort ändern Cambiar contraseña
	SETUP Model: IM-CE4TB	<b>CRC Software</b> CRC Software CRC Software CRC Software CRC Software
	SETUP Version: CRC:	CRC Software CRC Software CRC Software CRC Software

- Tenendo premuto il tasto **Set** per **3"** si accede alla visualizzazione dei parametri di setup
- Keeping the key **Set** pressed for **3 "** accesses the setup parameters display.
- En maintenant enfoncé le bouton **Set** pendant **3 "** pour accéder à l'affichage des paramètres de configuration.
- Durch Drücken der Taste **Set** für **3 "**wird die Anzeige der Setup-Parameter aufgerufen
- Si mantiene pulsado el botón **Set** durante **3 "** lleva a la pantalla de parámetros de configuración.

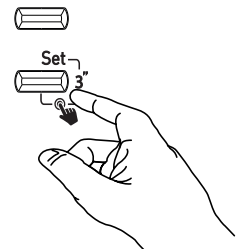

• Programmazione • Programming • Programmation • Programmierung  
• Programación

**Mbus**  
**CE4DF3MTCL1**  
**CE4DF3MTMID**

MID / no MID	SETUP Primary address 000 [SET]	<b>Indirizzo Primario</b> Primary address Première adresse Primäradresse Dirección primera	
	SETUP Second. address 00000000 [SET]	<b>Indirizzo Secondario</b> Secondary address Adresse secondaire Sekundäre Adresse Dirección secundaria	
	SETUP Baudrate 2400 bit/s [SET]	<b>Velocità di comunicazione</b> Communication speed Vitesse de communication Kommunikationsgeschwindigkeit Velocidad de comunicación	
	SETUP Int. time (MD) 15 Minutes [SET]	<b>Tempi di integrazione potenza media</b> Tempo di integrazione potenza media Temps d'intégration moyen Durchschnittliche Power-Integrationszeit Tiempo medio de integración de potencia	
	SETUP Run hours thr 00.00% [SET]	<b>Avvio conteggio</b> Start counting Commencez comptage Beginnen Sie zu zählen Empezar a contar	
	SETUP KTA 0001 [SET]	<b>Rapporto TA esterni</b> External CT ratio Rapport des TC externes Verhältnis des externen CT Relación de CT externa	
	SETUP KTV 001.00 [SET]	<b>Rapporto TV esterni</b> External VT ratio Rapport des TP externes Verhältnis des externen VT Relación de VT externa	
	SETUP Wiring 3n-3E [SET]	<b>Tipo di connessione</b> Connection type Type de connexion Verbindungstyp Tipo de conexión	
	no MID	SETUP Input mode Pulse [SET]	<b>Configurazione Ingresso</b> Input configuration Configuration d'entrée Eingangskonfiguration Configuración de entrada
		SETUP Input pulse unit Wh [SET]	<b>Unità di misura impulsi in ingresso</b> Input pulse measurement unit Unité de mesure d'impulsion d'entrée Messeingangsimpulse Einheit Unidad de medida de pulso de entrada
SETUP In. pulse weight 000.00 Wh [SET]		<b>Peso impulsi in ingresso</b> Input pulse weight Poids d'impulsion d'entrée Eingangsimpulsgewichts Peso de pulso de entrada	
MID / no MID	SETUP Change psw 0000 [SET]	<b>Modifica Password</b> Change Password Changer le mot de passe Kennwort ändern Cambiar contraseña	
	SETUP Model: IM-CE4TB	<b>CRC Software</b> CRC Software CRC Software CRC Software CRC Software	
	SETUP Version: CRC:		

- Tenendo premuto il tasto **Set** per **3"** si accede alla visualizzazione dei parametri di setup
- Keeping the key **Set** pressed for **3"** accesses the setup parameters display.
- En maintenant enfoncé le bouton **Set** pendant **3"** pour accéder à l'affichage des paramètres de configuration.
- Durch Drücken der Taste **Set** für **3"** wird die Anzeige der Setup-Parameter aufgerufen
- Si mantiene pulsado el botón **Set** durante **3"** lleva a la pantalla de parámetros de configuración.

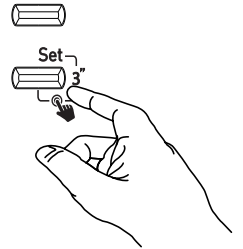

• Programmazione • Programming • Programmation • Programmierung  
• Programación

  
CE4TB0PCL1  
CE4TB0PMID

MID / no MID	SETUP	Int. time (MD)	5 Minutes	SET
	SETUP	Out. P. type	Ea+	SET
	SETUP	Out. P. weight	1 Wh	SET
	SETUP	Out. P. length	50 ms	SET
	SETUP	Run hours thr	00.00%	SET
	SETUP	KTA	0001	SET
	SETUP	KTV	001.00	SET
	SETUP	Wiring	3n-3E	SET
	SETUP	Input pulse unit	Wh	SET
	SETUP	In. pulse weight	000.00 Wh	SET
	SETUP	Change psw	0000	SET
	SETUP	Model: IM-CE4TB		
	SETUP	Version:		
	SETUP	CRC:		

**Tempo di integrazione potenza media**

Tempo di integrazione potenza media  
Temps d'intégration moyen  
Durchschnittliche Power-Integrationszeit  
Tiempo medio de integración de potencia

**Tipo di energia da tradurre sull'uscita impulsi**

Type of energy to be translated on the pulse output  
Type d'énergie à transmettre en sortie d'impulsion  
Energieart, die am Impulsausgang übersetzt werden soll  
Tipo de energia a traducir en la salida de impulsos

**Peso Impulso (kWh)**

Pulse Weight (kWh)  
Poids impulsion (kWh)  
Impulsengewicht (kWh)  
Peso del pulso (kWh)

**Durata Impulso (msec)**

Width of the pulse (msec)  
Durée d'impulsion (msec)  
Impulsdauer (msec)  
Duración del impulso (ms)

**Avvio conteggio**

Start counting  
Commencez comptage  
Beginnen Sie zu zählen  
Empezar a contar

**Rapporto TA esterni**

External CT ratio  
Rapport des TC externes  
Verhältnis des externen CT  
Relación de CT externa

**Rapporto TV esterni**

External VT ratio  
Rapport des TP externes  
Verhältnis des externen VT  
Relación de VT externa

**Tipo di connessione**

Connection type  
Type de connexion  
Verbindungstyp  
Tipo de conexión

**Unità di misura impulsi in ingresso**

Input pulse measurement unit  
Unité de mesure d'impulsion d'entrée  
Messeingangsimpulse Einheit  
Unidad de medida de pulso de entrada

**Peso impulsi in ingresso**

Input pulse weight  
Poids d'impulsion d'entrée  
Eingangsimpulsengewichts  
Peso de pulso de entrada

**Modifica Password**

Change Password  
Changer le mot de passe  
Kennwort ändern  
Cambiar contraseña

**CRC Software**

CRC Software  
CRC Software  
CRC Software  
CRC Software

- Tenendo premuto il tasto **Set** per **3"** si accede alla visualizzazione dei parametri di setup
- Keeping the key **Set** pressed for **3 "** accesses the setup parameters display.
- En maintenant enfoncé le bouton **Set** pendant **3 "** pour accéder à l'affichage des paramètres de configuration.
- Durch Drücken der Taste **Set** für **3 "** wird die Anzeige der Setup-Parameter aufgerufen
- Si mantiene pulsado el botón **Set** durante **3 "** lleva a la pantalla de parámetros de configuración.

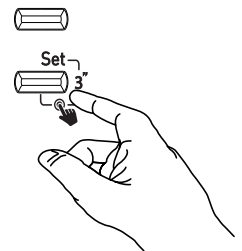

## • Programmazione • Programming • Programmation • Programmierung • Programación

- Modifica dati di SETUP
- Changing SETUP data
- Modification des données SETUP
- Ändern der Setup-Daten
- Modificación de los datos de configuración

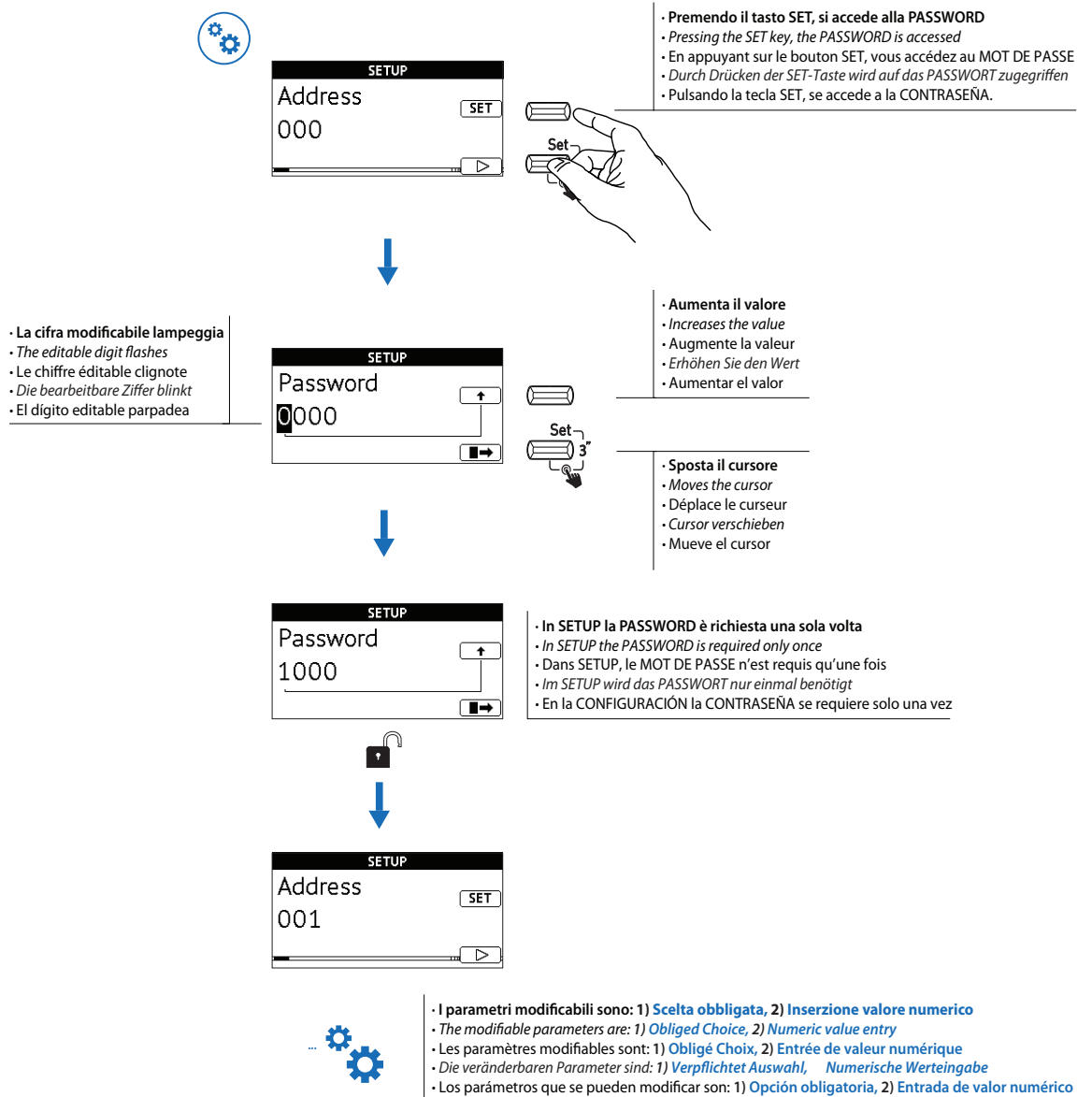

## • Programmazione • Programming • Programmation • Programmierung • Programación

- I parametri modificabili sono:
- The modifiable parameters are:
- Les paramètres modifiables sont:
- Die veränderbaren Parameter sind:
- Los parámetros que se pueden modificar son:



1

- Scelta obbligata
- Obligated Choice
- Obligé Choix
- Verpflichtet Auswahl
- Opción obligatoria

- La cifra modificabile lampeggia
- The editable digit flashes
- Le chiffre éditabile clignote
- Die bearbeitbare Ziffer blinkt
- El dígito editable parpadea

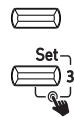
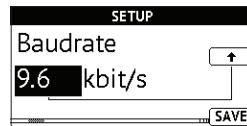

- Cambia la scelta
- Change the choice
- Changer le choix
- Ändern Sie die Auswahl
- Cambiar la elección

- Salva la modifica e sposta al setup successivo
- Save the change and move to the next setup
- Enregistrez la modification et passez à la configuration suivante
- Speichern Sie die Änderung und fahren Sie mit dem nächsten Setup fort
- Guarde el cambio y pase a la siguiente configuración

2

- Inserzione valore numerico
- Numeric value entry
- Entrée de valeur numérique
- Numerische Werteingabe
- Entrada de valor numérico

- La cifra modificabile lampeggia
- The editable digit flashes
- Le chiffre éditabile clignote
- Die bearbeitbare Ziffer blinkt
- El dígito editable parpadea

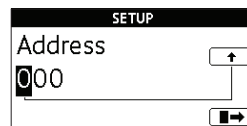

x 2

- Sposta alla cifra modificata successiva
- Move to the next digit modified
- Déplacer vers le chiffre suivant modifié
- Bewegen Sie zur nächsten Stelle geändert
- Mover a la siguiente figura modificada



x 1

- Aumenta il valore
- Increases the value
- Augmente la valeur
- Erhöhen Sie den Wert
- Aumentar el valor

- Salvare
- Save
- Sauver
- Speichern
- Salvar

## • Comunicazione

### Protocollo di comunicazione MODBUS

I contatori di energia con uscita MODBUS comunicano utilizzando la logica di comunicazione master/slave.

#### Tipologia di indirizzamento:

- punto-punto (il master comunica con un solo dispositivo slave alla volta).

La comunicazione avviene con modalità RTU (Remote Terminal Unit).

#### Sintassi di comunicazione:

Conformemente al protocollo MODBUS®, affinché un messaggio sia considerato valido dai contatori d'energia, il tempo massimo di attesa tra due parti del messaggio stesso deve essere inferiore a 3,5 volte il cosiddetto "tempo di intercarattere" (carattere = 8bit di dati).

Per la sintesi standard di comunicazione fare riferimento alle mappe di comunicazione MODBUS disponibili sul sito <http://www.imeitaly.com/>.

Il tipo di protocollo MODBUS usato è input Register a 16 bit.

### Protocollo di comunicazione MBUS

I contatori di energia con uscita MBUS comunicano utilizzando la logica di comunicazione master/slave e seguono le indicazioni della specifica Standard EN13757-2.

#### Tipologia di indirizzamento:

- punto-punto (il master comunica con un solo dispositivo slave alla volta).

#### Sintassi di comunicazione:

Per la sintesi standard di comunicazione fare riferimento alle mappe di comunicazione MBUS disponibili sul sito [http://www.imeitaly.com](http://www.imeitaly.com/)

## • Communication

### **MODBUS communication protocol**

*Energy meters with MODBUS output communicate using the master / slave communication logic.*

#### **Type of addressing:**

- *point-to-point (the master communicates with only one slave device at a time).*

*Communication takes place in RTU (Remote Terminal Unit) mode.*

#### **Communication syntax:**

*In accordance with the MODBUS® protocol, for a message to be considered valid by the energy meters, the maximum waiting time between two parts of the message must be less than 3.5 times the so-called "inter-character time" (character = 8bit of data).*

*For the standard communication summary, refer to the MODBUS communication maps available on the website*

*<http://www.imeitaly.com/>.*

*The type of MODBUS protocol used is 16-bit input register.*

### **MBUS communication protocol**

*Energy meters with MBUS output communicate using the master / slave communication logic and follow the indications of the Standard EN13757-2 specification.*

#### **Type of addressing:**

- *point-to-point (the master communicates with only one slave device at a time).*

#### **Communication syntax:**

*For the standard communication summary, refer to the MBUS communication maps available on the website*

*[http://www.imeitaly.com](http://www.imeitaly.com/)*



## • Communication

### Protocole de communication MODBUS

Les compteurs d'énergie avec sortie MODBUS communiquent en utilisant la logique de communication maître / esclave.

#### Type d'adressage:

- point à point (le maître ne communique qu'avec un seul appareil esclave à la fois).

La communication a lieu en mode RTU (Remote Terminal Unit).

#### Syntaxe de communication:

Conformément au protocole MODBUS®, pour qu'un message soit considéré comme valide par les compteurs d'énergie, le temps d'attente maximum entre deux parties du message doit être inférieur à 3,5 fois le temps dit "inter-caractères" (caractère = 8 bits de données).

Pour le récapitulatif de communication standard, reportez-vous aux plans de communication MODBUS disponibles sur le site <http://www.imeitaly.com/>.

Le type de protocole MODBUS utilisé est un registre d'entrée 16 bits.

### Protocole de communication MBUS

Les compteurs d'énergie avec sortie MBUS communiquent en utilisant la logique de communication maître / esclave et suivent les indications de la spécification de la norme EN13757-2.

#### Type d'adressage:

- point à point (le maître ne communique qu'avec un seul appareil esclave à la fois).

#### Syntaxe de communication:

Pour le récapitulatif de communication standard, reportez-vous aux plans de communication MBUS disponibles sur le site

<http://www.imeitaly.com>

## • Kommunikation

### MODBUS-Kommunikationsprotokoll

Energiezähler mit MODBUS-Ausgang kommunizieren über die Master / Slave-Kommunikationslogik.

#### Art der Adressierung:

- Punkt-zu-Punkt (der Master kommuniziert jeweils nur mit einem Slave-Gerät).

Die Kommunikation erfolgt im RTU-Modus (Remote Terminal Unit).

#### Kommunikationssyntax:

Gemäß dem MODBUS®-Protokoll muss die maximale Wartezeit zwischen zwei Teilen der Nachricht weniger als das 3,5-fache der sogenannten "Zeit zwischen Zeichen" betragen (Zeichen = 8 Bit Daten), damit eine Nachricht von den Energiezählern als gültig angesehen wird).

Eine Zusammenfassung der Standardkommunikation finden Sie in den MODBUS-Kommunikationskarten auf der Website

<http://www.imeitaly.com/>.

Der verwendete MODBUS-Protokolltyp ist ein 16-Bit-Eingangsregister.

### MBUS-Kommunikationsprotokoll

Energiezähler mit MBUS-Ausgang kommunizieren über die Master / Slave-Kommunikationslogik und folgen den Angaben der Norm EN13757-2.

#### Art der Adressierung:

- Punkt-zu-Punkt (der Master kommuniziert jeweils nur mit einem Slave-Gerät).

#### Kommunikationssyntax:

Eine Zusammenfassung der Standardkommunikation finden Sie in den MBUS-Kommunikationskarten auf der Website

<http://www.imeitaly.com>

## • Comunicación

### **Protocolo de comunicación MODBUS**

Los medidores de energía con salida MODBUS se comunican mediante la lógica de comunicación maestro / esclavo.

#### **Tipo de direccionamiento:**

- punto a punto (el maestro se comunica con un solo dispositivo esclavo a la vez).

La comunicación se realiza en modo RTU (Unidad terminal remota).

#### **Sintaxis de comunicación:**

De acuerdo con el protocolo MODBUS®, para que un mensaje sea considerado válido por los contadores de energía, el tiempo máximo de espera entre dos partes del mensaje debe ser inferior a 3,5 veces el denominado "tiempo entre caracteres" (carácter = 8 bits de datos).

Para obtener el resumen de comunicación estándar, consulte los mapas de comunicación MODBUS disponibles en el sitio web <http://www.imeitaly.com/>.

El tipo de protocolo MODBUS utilizado es el registro de entrada de 16 bits.

### **Protocolo de comunicación MBUS**

Los contadores de energía con salida MBUS se comunican mediante la lógica de comunicación maestro / esclavo y siguen las indicaciones de la especificación de la Norma EN13757-2.































#### **Tipo de direccionamiento:**

- punto a punto (el maestro se comunica con un solo dispositivo esclavo a la vez).

#### **Sintaxis de comunicación:**

Para obtener el resumen de comunicación estándar, consulte los mapas de comunicación MBUS disponibles en el sitio web <http://www.imeitaly.com/>

## • Caratteristiche tecniche







Involucro							
Dimensioni (l x h x p)	71,2 x 92,4 x 66mm						
Collegamenti	<table border="1" style="width: 100%; border-collapse: collapse;"> <tr> <td style="text-align: center;">  L1-L2-L3 V1-V2-V3                 </td> <td style="text-align: center;">  11 mm MAX 1 x 10 mm<sup>2</sup>  1 x 10 mm<sup>2</sup>  1 x 16 mm<sup>2</sup> </td> <td style="text-align: center;">                     Recommended torque 1,6 to 2Nm COMBI PZ2  </td> </tr> <tr> <td style="text-align: center;">  1 C RS485 Mbus                 </td> <td style="text-align: center;">  8 mm MAX 1 x 1 mm<sup>2</sup>  1 x 1 mm<sup>2</sup>  1 x 1,5 mm<sup>2</sup> </td> <td style="text-align: center;">                     Recommended torque 0,2Nm 0,5 x 2,5mm  </td> </tr> </table>	 L1-L2-L3 V1-V2-V3	 11 mm MAX 1 x 10 mm <sup>2</sup>  1 x 10 mm <sup>2</sup>  1 x 16 mm <sup>2</sup>	Recommended torque 1,6 to 2Nm COMBI PZ2 	 1 C RS485 Mbus	 8 mm MAX 1 x 1 mm <sup>2</sup>  1 x 1 mm <sup>2</sup>  1 x 1,5 mm <sup>2</sup>	Recommended torque 0,2Nm 0,5 x 2,5mm 
 L1-L2-L3 V1-V2-V3	 11 mm MAX 1 x 10 mm <sup>2</sup>  1 x 10 mm <sup>2</sup>  1 x 16 mm <sup>2</sup>	Recommended torque 1,6 to 2Nm COMBI PZ2 					
 1 C RS485 Mbus	 8 mm MAX 1 x 1 mm <sup>2</sup>  1 x 1 mm <sup>2</sup>  1 x 1,5 mm <sup>2</sup>	Recommended torque 0,2Nm 0,5 x 2,5mm 					
Grado di protezione:	Frontale IP54, Morsetti IP20						
Peso:	210 g						
Display							
Tipo:	Grafico retroilluminato 1.8 pollici (256x128)						
Alimentazione ausiliaria							
Derivata dalle prese di tensione (Autoalimentato)							
Misura							
Rete trifase 3 e 4 fili							
<b>Tensione (TRMS)</b> Misura indiretta							
Tensione trifase nominale Un:	3x100...3x400V - 3x100/173...3x230/400V						
Autoconsumo circuito di tensione:	Max. 1,5VA trifase						
<b>Corrente (TRMS)</b> Misura indiretta	Cod. <b>CE4TB0PCL1 - CE4TBDTCL1 - CE4TBMTC11</b>	<b>TA/1A - / 5A</b> I <sub>min</sub> : 0,01A - I <sub>n</sub> : 5A - I <sub>max</sub> : 6A					
	Cod. <b>CE4TB0PMID - CE4TBDTMID - CE4TBMTMID</b>	<b>TA / 5A</b> I <sub>min</sub> : 0,05A - I <sub>n</sub> : 5A - I <sub>max</sub> : 6A					
Autoconsumo circuito di corrente:	Max. 1,8W per fase						
Sovraccarico di breve durata (IEC/EN 62053-21, IEC/EN 62053-23):	20 I <sub>max</sub> / 0,5sec.						
Frequenza							
Frequenza nominale	F <sub>n</sub> 50Hz; 60Hz						
Variazione ammessa	49...51 Hz, 59...61Hz						
Energie							
Cod. <b>CE4TB0PCL1 - CE4TBDTCL1 - CE4TBMTC11</b>	Classe di precisione Energia Attiva: 1 (IEC/EN 62053-21) Classe di precisione Energia Reattiva: 2 (IEC/EN 62053-23)						
Cod. <b>CE4TB0PMID - CE4TBDTMID - CE4TBMTMID</b>	Classe di precisione Energia Attiva: B (EN 50470-1, -3) Classe di precisione Energia Reattiva: 2 (IEC/EN 62053-23)						

## • Caratteristiche tecniche

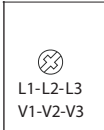
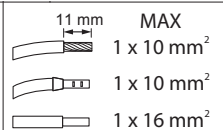
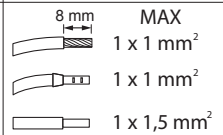
Ingressi digitali	
Tensione:	12-24V DC
Corrente:	Max. 10 mA
Uscita impulsi	
Tipo:	Optorelè con contatto SPST-NO libero da potenziale
Tensione:	Max. 27 V AC/DC
Corrente:	Max. 50 mA
Condizioni di utilizzo	
Temperatura di funzionamento:	(-25°C) ÷ (55°C) [-13°F ÷ 131°F]
Temperatura di immagazzinamento:	(-25°C) ÷ (70°C) [-13°F ÷ 158°F]
Umidità:	Adatto all'utilizzo in clima tropicale
Massima potenza dissipata:	≤ 10 W
Ambiente meccanico:	M1
Ambiente elettromagnetico:	E2
Umidità relativa:	95% senza condensa (EN50472-1)
Installazione:	Montaggio del contatore all'interno di un quadro IP51
Utilizzo:	Uso interno

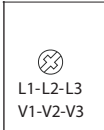
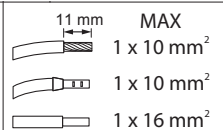
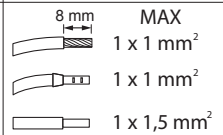
Marcatura CE	
I dispositivi <b>CE4TB0PCL1 - CE4TBDTCL1 - CE4TBMTC11 - CE4TB0PMID - CE4TBDTMID - CE4TBMTC11</b> sono conformi: <ul style="list-style-type: none"> <li>• Alle disposizioni della Direttiva Europea sulla compatibilità elettromagnetica (EMC) n° 2014/32/EU</li> <li>• Alla Direttiva bassa tensione n° 2014/35/UE.</li> <li>• Alla Direttiva 2011/65/EU modificata dalla direttiva 2015/863 (RoHS 2).</li> </ul>	
Compatibilità elettromagnetica	
Prove in accordo con IEC/EN 62052-11; EN 50470-1; EN 62053-21 e EN 50470-3	
Isolamento (IEC/EN 62052-11, IEC/EN 62053-21)	
Categoria di misura:	III
Grado d'inquinamento:	2
Tensione d'isolamento, Ui:	300V Fase-Terra
Tenuta all'impulso:	-Ingressi di misura / Ingressi digitali I/O: onda 1,2 / 50µs 0,5 J: 6kV tensione alternata 50Hz / 1 min.: 4kV -Tutti i circuiti /Massa tensione alternata 50Hz / 1 min.: 4kV
Superficie frontale:	Classe II

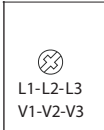
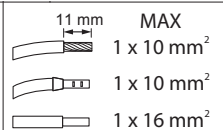
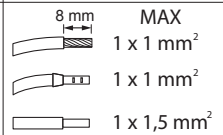
**• Technical characteristics**

Case								
Dimension (w x h x d)	71,2 x 92,4 x 66mm							
Connections	<table border="1" style="width: 100%; border-collapse: collapse;"> <tr> <td style="text-align: center; vertical-align: middle;">  L1-L2-L3 V1-V2-V3                 </td> <td style="text-align: center; vertical-align: middle;">  1 C RS485 Mbus                 </td> <td style="text-align: center; vertical-align: middle;">  1 x 1 mm<sup>2</sup> 1 x 1 mm<sup>2</sup> 1 x 1,5 mm<sup>2</sup> </td> <td style="text-align: center; vertical-align: middle;">                     Recommended torque 1,6 to 2Nm COMBI PZ2  </td> </tr> <tr> <td colspan="2"></td> <td style="text-align: center; vertical-align: middle;">                     Recommended torque 0,2Nm 0,5 x 2,5mm  </td> </tr> </table>	 L1-L2-L3 V1-V2-V3	 1 C RS485 Mbus	 1 x 1 mm <sup>2</sup> 1 x 1 mm <sup>2</sup> 1 x 1,5 mm <sup>2</sup>	Recommended torque 1,6 to 2Nm COMBI PZ2 			Recommended torque 0,2Nm 0,5 x 2,5mm 
 L1-L2-L3 V1-V2-V3	 1 C RS485 Mbus	 1 x 1 mm <sup>2</sup> 1 x 1 mm <sup>2</sup> 1 x 1,5 mm <sup>2</sup>	Recommended torque 1,6 to 2Nm COMBI PZ2 					
		Recommended torque 0,2Nm 0,5 x 2,5mm 						
Degree of protection	Front face IP54, Terminals IP20							
Weight:	210g							
Display								
Type:	Graphic, backlit 1.8 inches (256x128)							
Auxiliary supply								
Derived from the voltage terminals (Self-supplied)								
Measurement								
Three-phase 3 and 4-wire network								
<b>Voltage (TRMS)</b> Indirect measurement								
Three-phase rated voltage Un:	3x100...3x400V - 3x100/173...3x230/400V							
Power consumption voltage circuit:	Max. 1,5VA three-phase							
<b>Current (TRMS)</b> Indirect measurement	Cod. <b>CE4TB0PCL1 - CE4TBDTCL1 - CE4TBMTC11</b>	<b>CT/1A - / 5A</b> <i>I<sub>min</sub>: 0,01A - I<sub>n</sub>: 5A - I<sub>max</sub>: 6A</i>						
	Cod. <b>CE4TB0PMID - CE4TBDTMID - CE4TBMTC12</b>	<b>CT/ 5A</b> <i>I<sub>min</sub>: 0,05A - I<sub>n</sub>: 5A - I<sub>max</sub>: 6A</i>						
Current circuit power consumption	Max. 1,8W per phase							
Short-time overcurrent (IEC/EN 62053-21, IEC/EN 62053-23):	20 I <sub>max</sub> / 0,5sec.							
Frequency								
Rated frequency	F <sub>n</sub> 50Hz; 60Hz							
Permitted variation	49...51 Hz, 59...61Hz							
Energies								
Cod. <b>CE4TB0PCL1 - CE4TBDTCL1 - CE4TBMTC11</b>	Active energy accuracy class: 1 (IEC/EN 62053-21) Reactive energy accuracy class: 2 (IEC/EN 62053-23)							
Cod. <b>CE4TB0PMID - CE4TBDTMID - CE4TBMTC12</b>	Active energy accuracy class: B (EN 50470-1, -3) Reactive energy accuracy class: 2 (IEC/EN 62053-23)							

## • Technical characteristics

<b>Digital inputs</b>	
Voltage:	12-24V DC
Current:	Max. 10 mA
<b>Pulse output</b>	
Type:	Optorelays with potential-free SPST-NO contact
Voltage:	Max. 27 V AC/DC
Current:	Max. 50 mA
<b>Operating conditions</b>	
Operating temperature:	(-25°C) ÷ (55°C) [-13°F ÷ 131°F]
Storage temperature:	(-25°C) ÷ (70°C) [-13°F ÷ 158°F]
Humidity:	Suitable for tropical climates
Max. dissipated power:	≤ 10 W
Mechanical environment:	M1
Electromagnetic environment:	E2
Relative humidity:	95% not condensing (EN50472-1)
Installation:	Mounting the KWH-meter in a IP51 switchboard
Use:	Indoor

### CE Marking

The **CE4TB0PCL1 - CE4TBDTCL1 - CE4TBMTC11 - CE4TB0PMID - CE4TBDTMID - CE4TBMTCMID** devices comply with:

- The requirements of the European directive on electromagnetic compatibility (EMC) n° 2014/32/EU
- The low voltage directive n° 2014/35/UE.
- Directive 2011/65/EU modified by directive 2015/863 (RoHS 2).



















### Electromagnetic compatibility

According to IEC/EN 62052-11; EN 50470-1; EN 62053-21 and EN 50470-3

### Insulation (IEC/EN 62052-11, IEC/EN 62053-21)

Measurement category:	III
Degree of pollution:	2
Insulation voltage, U <sub>i</sub> :	300V Phase-Earth
Impulse withstand voltage	- Measuring inputs / Digital I/O inputs wave 1,2 / 50µs 0,5 J: 6kV alternate voltage 50Hz / 1 min.: 4kV - All circuits / earth alternate voltage 50Hz / 1 min.: 4kV
Front surface:	Class II

## • Caractéristiques techniques

Boîtier										
Dimensions (l x h x p)	71,2 x 92,4 x 66mm									
Raccordement:	<table border="1" style="width: 100%; border-collapse: collapse;"> <tr> <td style="text-align: center; vertical-align: middle;">  L1-L2-L3 V1-V2-V3                 </td> <td style="text-align: center; vertical-align: middle;">  1 C RS485 Mbus                 </td> <td style="text-align: center; vertical-align: middle;">  COMBI PZ2                 </td> </tr> <tr> <td style="text-align: center; vertical-align: middle;">  11 mm MAX 1 x 10 mm<sup>2</sup> </td> <td style="text-align: center; vertical-align: middle;">  8 mm MAX 1 x 1 mm<sup>2</sup> </td> <td style="text-align: center; vertical-align: middle;">  0,5 x 2,5mm                 </td> </tr> <tr> <td colspan="2"></td> <td style="text-align: center; vertical-align: middle;">                     Recommended torque 1,6 to 2Nm                      Recommended torque 0,2Nm                 </td> </tr> </table>	 L1-L2-L3 V1-V2-V3	 1 C RS485 Mbus	 COMBI PZ2	 11 mm MAX 1 x 10 mm <sup>2</sup>	 8 mm MAX 1 x 1 mm <sup>2</sup>	 0,5 x 2,5mm			Recommended torque 1,6 to 2Nm Recommended torque 0,2Nm
 L1-L2-L3 V1-V2-V3	 1 C RS485 Mbus	 COMBI PZ2								
 11 mm MAX 1 x 10 mm <sup>2</sup>	 8 mm MAX 1 x 1 mm <sup>2</sup>	 0,5 x 2,5mm								
		Recommended torque 1,6 to 2Nm Recommended torque 0,2Nm								
Indice de protection:	Face avant IP54, Bornes IP20									
Poids:	210 g									
Afficheur										
Type:	Graphic, rétroéclairage 1.8 pouces (256x128)									
Alimentation axiliaire										
Dérivée par le prises de tension (Auto-alimentée)										
Mesure										
Reseau triphasé 3 et 4 fils										
Tension (TRMS)										
Mesure indirecte										
Tension triphasée nominale Un:	3x100...3x400V - 3x100/173...3x230/400V									
Autoconsommation circuit de tension:	Max. 1,5VA triphasée									
Courant (TRMS) Mesure indirecte	Cod. <b>CE4TB0PCL1 - CE4TBDTCL1 - CE4TBMTC11</b>	<b>TC/1A - / 5A</b> I <sub>min</sub> : 0,01A - I <sub>n</sub> : 5A - I <sub>max</sub> : 6A								
	Cod. <b>CE4TB0PMID - CE4TBDTMID - CE4TBMTC12</b>	<b>TC/5A</b> I <sub>min</sub> : 0,05A - I <sub>n</sub> : 5A - I <sub>max</sub> : 6A								
Autoconsommation circuit de courant	Max. 1,8W par phase									
Surintensité de courte durée (IEC/EN 62053-21, IEC/EN 62053-23):	20 I <sub>max</sub> / 0,5sec.									
Fréquence										
Fréquence nominale	F <sub>n</sub> 50Hz; 60Hz									
Variation admise	49...51 Hz, 59...61Hz									
Energies										
Cod. <b>CE4TB0PCL1 - CE4TBDTCL1 - CE4TBMTC11</b>	Classe de précision Energie Active: 1 (IEC/EN 62053-21) Classe de précision Energie Réactive: 2 (IEC/EN 62053-23)									
Cod. <b>CE4TB0PMID - CE4TBDTMID - CE4TBMTC12</b>	Classe de précision Energie Active: B (EN 50470-1, -3) Classe de précision Energie Réactive: 2 (IEC/EN 62053-23)									





































## • Caractéristiques techniques

Entrée numérique	
Tension:	12-24V DC
Courant:	Max. 10 mA
Sortie impulsions	
Type:	Optorelays avec contact SPST-NO libre de potentiel
Tension:	Max. 27 V AC/DC
Courant:	Max. 50 mA
Conditions d' utilisation	
Température de fonctionnement:	(-25°C) ÷ (55°C) [-13°F ÷ 131°F]
Température de stockage:	(-25°C) ÷ (70°C) [-13°F ÷ 158°F]
Humidité:	Convient pour les climats tropicaux
Dissipation thermique:	≤ 10 W
Environnement mécanique:	M1
Environnement électromagnétique:	E2
Humidité relative:	95% sans condensation (EN50472-1)
Installation:	Installation du compteur dans un panneau IP51
Utilisation:	Utilisation interne

Marquage CE	
<p>Le produits <b>CE4TB0PCL1 - CE4TBDTCL1 - CE4TBMTC11 - CE4TB0PMID - CE4TBDTMID - CE4TBMTC11</b> répondent aux:</p> <ul style="list-style-type: none"> <li>• Dispositions de la directive européenne sur la compatibilité électromagnétique (CEM) n° 2014/32/UE</li> <li>• A directive basse tension n° 2014/35/EU.</li> <li>• A directive 2011/65/UE modifiée par directive 2015/863 (RoHS 2).</li> </ul>	
Compatibilité électromagnétique	
Essais conformément a IEC/EN 62052-11; EN 50470-1; EN 62053-21 et EN 50470-3	
Isolation (IEC/EN 62052-11, IEC/EN 62053-21)	
Catégorie de mesure:	III
Degré de pollution:	2
Tension d' isolation, Ui:	300V Phase-Terre
Tension de choc assignée:	- Entrée de mesure / Entrée I/O numérique: onda 1,2 / 50µs 0,5 J: 6kV tension alternatif 50Hz / 1 min.: 4kV -Tous les circuits /Terre: tension alternatif 50Hz / 1 min.: 4kV
Face avant:	Classe II



## • Technische Daten



















Gehäuse													
Abmessung (L x H x T)	71,2 x 92,4 x 66mm												
Anschlüsse	<table border="1" style="width: 100%; border-collapse: collapse;"> <tr> <td style="text-align: center;">  L1-L2-L3 V1-V2-V3                 </td> <td style="text-align: center;">  1 C RS485 Mbus                 </td> <td style="text-align: center;">  COMBI PZ2                 </td> </tr> <tr> <td style="text-align: center;">  11 mm MAX 1 x 10 mm<sup>2</sup> </td> <td style="text-align: center;">  8 mm MAX 1 x 1 mm<sup>2</sup> </td> <td style="text-align: center;">  Recommended torque 0,2Nm 0,5 x 2,5mm                 </td> </tr> <tr> <td style="text-align: center;">  1 x 10 mm<sup>2</sup> </td> <td style="text-align: center;">  1 x 1 mm<sup>2</sup> </td> <td style="text-align: center;">  1 x 16 mm<sup>2</sup> </td> </tr> <tr> <td style="text-align: center;">  1 x 16 mm<sup>2</sup> </td> <td style="text-align: center;">  1 x 1,5 mm<sup>2</sup> </td> <td style="text-align: center;">  1 x 10 mm<sup>2</sup> </td> </tr> </table>	 L1-L2-L3 V1-V2-V3	 1 C RS485 Mbus	 COMBI PZ2	 11 mm MAX 1 x 10 mm <sup>2</sup>	 8 mm MAX 1 x 1 mm <sup>2</sup>	 Recommended torque 0,2Nm 0,5 x 2,5mm	 1 x 10 mm <sup>2</sup>	 1 x 1 mm <sup>2</sup>	 1 x 16 mm <sup>2</sup>	 1 x 16 mm <sup>2</sup>	 1 x 1,5 mm <sup>2</sup>	 1 x 10 mm <sup>2</sup>
 L1-L2-L3 V1-V2-V3	 1 C RS485 Mbus	 COMBI PZ2											
 11 mm MAX 1 x 10 mm <sup>2</sup>	 8 mm MAX 1 x 1 mm <sup>2</sup>	 Recommended torque 0,2Nm 0,5 x 2,5mm											
 1 x 10 mm <sup>2</sup>	 1 x 1 mm <sup>2</sup>	 1 x 16 mm <sup>2</sup>											
 1 x 16 mm <sup>2</sup>	 1 x 1,5 mm <sup>2</sup>	 1 x 10 mm <sup>2</sup>											
Schutzklasse:	Frontal IP54, Klemmen IP20												
Gewicht:	210 g												
Display													
Typ:	Rückbeleuchtete Anzeige, 1,8 Zoll (256x128)												
Hilfsspannung													
Abgeleitet von den Spannungsanschlüssen (Selbstversorgung)													
Messung													
Drehstromnetz 3 und 4 Leiter													
<b>Spannung (TRMS)</b> Indirekte Messung													
Dreiphasige Nennspannung Un:	3x100...3x400V - 3x100/173...3x230/400V												
Selbstverbrauch Spannungskreis	Max. 1,5VA dreiphasig												
<b>Strom (TRMS)</b> Indirekte Messung	Cod. <b>CE4TB0PCL1 - CE4TBDTCL1 - CE4TBMTC11</b>	<b>CT/1A - / 5A</b> <i>I<sub>min</sub>: 0,01A - I<sub>n</sub>: 5A - I<sub>max</sub>: 6A</i>											
	Cod. <b>CE4TB0PMID - CE4TBDTMID - CE4TBMTC11</b>	<b>CT/ 5A</b> <i>I<sub>min</sub>: 0,05A - I<sub>n</sub>: 5A - I<sub>max</sub>: 6A</i>											
Selbstverbrauch Stromkreis	Max. 1,8W pro Phase												
Kurzzeitige Überlastung (IEC/EN 62053-21, IEC/EN 62053-23):	20 I <sub>max</sub> / 0,5sec.												
Frequenz													
Nennfrequenz	F <sub>n</sub> 50Hz; 60Hz												
Spannungsanschlussklemmen	49...51 Hz, 59...61Hz												
Energie													
Cod. <b>CE4TB0PCL1 - CE4TBDTCL1 - CE4TBMTC11</b>	Genauigkeitsklasse Wirkenergie: 1 (IEC/EN 62053-21) Genauigkeitsklasse Blindenergie: 2 (IEC/EN 62053-23)												
Cod. <b>CE4TB0PMID - CE4TBDTMID - CE4TBMTC11</b>	Genauigkeitsklasse Wirkenergie: B (EN 50470-1, -3) Genauigkeitsklasse Blindenergie: 2 (IEC/EN 62053-23)												

## • Technische Daten

<b>Digitaleingänge</b>	
Spannung:	12-24V DC
Strom:	Max. 10 mA
<b>Impulsausgang</b>	
Typ:	Optorelais mit SPST-NO Kontakt potentialfrei
Spannung:	Max. 27 V AC/DC
Strom:	Max. 50 mA
<b>Gebrauchsbedingungen</b>	
Betriebstemperatur:	(-25°C) ÷ (55°C) [-13°F ÷ 131°F]
Lagertemperatur:	(-25°C) ÷ (70°C) [-13°F ÷ 158°F]
Feuchtigkeit:	Geeignet für den Einsatz in tropischem Klima
Maximale Verlustleistung:	≤ 10 W
Mechanische Umgebung:	M1
Elektromagnetische Umgebung:	E2
Relative Feuchte:	95% ohne Kondensation (EN50472-1)
Installieren:	Montage des Zählers innerhalb eines IP51-Panels
Ausnutzung:	Interne Verwendung

<b>CE-Kennzeichnung</b>	
<p>Die Geräte <b>CE4TB0PCL1 - CE4TBDTCL1 - CE4TBMTC11 - CE4TB0PMID - CE4TBDTMID - CE4TBMTCMID</b> entsprechen</p> <ul style="list-style-type: none"> <li>• Den Bestimmungen der Europäischen Richtlinie über die elektromagnetische Verträglichkeit (EMV) Nr. 2014/32/EU</li> <li>• Der Niederspannungsrichtlinie 2014/35/EU</li> <li>• Der Richtlinie 2011/65/EG geändert durch Richtlinie 2015/863 (RoHS 2)</li> </ul>	
<b>Elektromagnetische Verträglichkeit</b>	
Prüfungen gemäß IEC/EN 62052-11; EN 50470-1; EN 62053-21 und EN 50470-3	
<b>Isolation (IEC/EN 62052-11, IEC/EN 62053-21)</b>	
Messkategorie:	III
Verschmutzungsgrad:	2
Isolationsspannung, U <sub>i</sub> :	300V Phase-Erde
Impulsdauer:	-Messeingänge / Digitale I / O-Eingänge: Welle 1,2 / 50µs 0,5 J: 6kV Wechselspannung 50Hz / 1 min.: 4kV -Alle Stromkreise /Masse Wechselspannung 50Hz / 1 min.: 4kV
Frontfläche:	Klasse II

## • Características técnicas

Caja							
Dimensiones (l x h x p)	71,2 x 92,4 x 66mm						
Conexión	<table border="1" style="width: 100%; border-collapse: collapse;"> <tr> <td style="text-align: center;">  L1-L2-L3 V1-V2-V3                 </td> <td style="text-align: center;">  1 C RS485 Mbus                 </td> <td style="text-align: center;">  MAX 1 x 10 mm<sup>2</sup> 1 x 10 mm<sup>2</sup> 1 x 16 mm<sup>2</sup> </td> <td style="text-align: center;">  MAX 1 x 1 mm<sup>2</sup> 1 x 1 mm<sup>2</sup> 1 x 1,5 mm<sup>2</sup> </td> <td style="text-align: center;">                     Recommended torque 1,6 to 2Nm COMBI PZ2   </td> <td style="text-align: center;">                     Recommended torque 0,2Nm 0,5 x 2,5mm   </td> </tr> </table>	 L1-L2-L3 V1-V2-V3	 1 C RS485 Mbus	 MAX 1 x 10 mm <sup>2</sup> 1 x 10 mm <sup>2</sup> 1 x 16 mm <sup>2</sup>	 MAX 1 x 1 mm <sup>2</sup> 1 x 1 mm <sup>2</sup> 1 x 1,5 mm <sup>2</sup>	Recommended torque 1,6 to 2Nm COMBI PZ2 	Recommended torque 0,2Nm 0,5 x 2,5mm 
 L1-L2-L3 V1-V2-V3	 1 C RS485 Mbus	 MAX 1 x 10 mm <sup>2</sup> 1 x 10 mm <sup>2</sup> 1 x 16 mm <sup>2</sup>	 MAX 1 x 1 mm <sup>2</sup> 1 x 1 mm <sup>2</sup> 1 x 1,5 mm <sup>2</sup>	Recommended torque 1,6 to 2Nm COMBI PZ2 	Recommended torque 0,2Nm 0,5 x 2,5mm 		
Indice de protección:	Frente IP54, Terminales IP20						
Peso:	210 g						
Visualizador							
Type:	Gráfico retroiluminado 1,8 pulgadas (256x128)						
Alimentación auxiliar							
Derivada de la toma de presión (autoalimentado)							
Medidas							
Red trifásica 3 o 4 hilos							
<b>Tensión (TRMS)</b> Medida indirecta							
Tensión trifásica nominal Un:	3x100...3x400V - 3x100/173...3x230/400V						
Autoconsumo circuito de tensión:	Máx. 1,5VA trifásica						
<b>Corriente (TRMS)</b> Medida indirecta	Cod. <b>CE4TB0PCL1 - CE4TBDTCL1 - CE4TBMTCCL1</b>	<b>CT/1A - / 5A</b> I <sub>min</sub> : 0,01A - I <sub>n</sub> : 5A - I <sub>max</sub> : 6A					
	Cod. <b>CE4TB0PMID - CE4TBDTMID - CE4TBMTCMID</b>	<b>CT/ 5A</b> I <sub>min</sub> : 0,05A - I <sub>n</sub> : 5A - I <sub>max</sub> : 6A					
Autoconsumo circuito de corriente:	Máx. 1,8W por fase						
Sobrecorriente de breve duración (IEC/EN 62053-21, IEC/EN 62053-23):	20 I <sub>max</sub> / 0,5sec.						
<b>Frecuencia</b>							
Frecuencia nominal	F <sub>n</sub> 50Hz; 60Hz						
Variación admitida	49...51 Hz, 59...61Hz						
<b>Energía</b>							
Cod. <b>CE4TB0PCL1 - CE4TBDTCL1 - CE4TBMTCCL1</b>	Clase de precisión Energía Activa: 1 (IEC/EN 62053-21) Clase de precisión Energía Reactiva: 2 (IEC/EN 62053-23)						
Cod. <b>CE4TB0PMID - CE4TBDTMID - CE4TBMTCMID</b>	Clase de precisión Energía Activa: B (EN 50470-1, -3) Clase de precisión Energía Reactiva: 2 (IEC/EN 62053-23)						

## • Características técnicas

Entradas digitales	
Tensión:	12-24V DC
Corriente:	Máx. 10 mA
Salida impulsos	
Tipo:	Opto-relé con contacto SPST-NO libre de potencial
Tensión:	Máx. 27 V AC/DC
Corriente:	Máx. 50 mA
Condiciones de uso	
Temperatura de funcionamiento:	(-25°C) ÷ (55°C) [-13°F ÷ 131°F]
Temperatura de almacenaje:	(-25°C) ÷ (70°C) [-13°F ÷ 158°F]
Humedad:	Apto para la utilización en un clima tropical
Máxima potencia disipada:	≤ 10 W
Entorno mecánico:	M1
Entorno electromagnético:	E2
Humedad relativa:	95% sin condensación (EN50472-1)
Instalación:	Montaje del medidor dentro de un panel IP51
Utilización:	Uso en interiores

### Marcado CE

Los dispositivos **CE4TB0PCL1 - CE4TBDTCL1 - CE4TBMTC11 - CE4TB0PMID - CE4TBDTMID - CE4TBMTC11** son conformes:

- A las disposiciones de la Directiva europea sobre la compatibilidad electromagnética (EMC) n.º 2014/32/EU
- A la Directiva baja tensión n.º 2014/35/UE
- A la Directiva 2011/65/EU modificada por la directiva 2015/863 (RoHS 2)

### Compatibilidad electromagnética

Pruebas en conformidad a IEC/EN 62052-11; EN 50470-1; EN 62053-21 y EN 50470-3

### Aislamiento (IEC/EN 62052-11, IEC/EN 62053-21)

Categoría de medida:	III
Grado de polución:	2
Tensión de Aislamiento, Ui:	300V Fase-Tierra
Resistencia al impulso de tensión:	- Entradas de medición / Entradas digitales I/O: onda 1,2 / 50µs 0,5 J: 6kV tensión alterna 50Hz / 1 min.: 4kV -Todos los circuitos / Masa tensión alterna 50Hz / 1 min.: 4kV
Superficie frontal:	Clase II



**IME**

A Group brand |  **legrand**

BTicino S.p.A  
Viale Borri, 231  
21100 Varese (VA) ITALY  
☎: +39 02 44 878.1  
[www.imeitaly.com](http://www.imeitaly.com)



BTicino si riserva in qualsiasi momento il diritto di modificare i contenuti di questo opuscolo e di comunicare, in qualsiasi forma e modalità, i cambiamenti apportati allo stesso.  
BTicino reserves at any time the right to modify the contents of this booklet and to communicate, in any form and modality, the changes brought to the same.