



## Trimod MCS

**UK**

ENGLISH

3



---

## Contents

<b>1</b>	<b>Introduction</b>	<b>6</b>
1.1	Purpose of the manual	6
1.2	Symbols in the manual	6
1.3	Where and how to keep the manual	7
1.4	Update of the manual	7
1.5	Manufacturer's liability and guarantee	7
1.5.1	Guarantee terms	7
1.6	Copyright	8
<b>2</b>	<b>Regulatory and safety requirements</b>	<b>9</b>
2.1	General notes	9
2.2	Definitions of "Skilled Technician" and "Operator"	9
2.2.1	Skilled Technician	9
2.2.2	Operator	9
2.3	Personal Protective Equipment	10
2.4	Hazard signs in the workplace	10
2.5	Signs on the equipment	10
2.6	General warnings	11
2.7	How to proceed in an emergency	13
2.7.1	First-aid procedures	13
2.7.2	Fire procedures	13
<b>3</b>	<b>Unpacking and positioning</b>	<b>14</b>
3.1	Visual check	14
3.1.1	Equipment and supplied accessories check	14
3.2	Unpacking	14
3.3	Check of the content	16
3.4	Movement	16
3.5	Positioning constraints	17
3.6	Final operations	17

---

## Contents

<b>4</b>	<b>Installation</b>	<b>18</b>
4.1	Safety regulations	18
4.2	Electric connections	18
4.2.1	Safety warnings	18
4.2.2	Preliminary operations	19
4.2.3	Wiring	19
4.2.4	Earthing	20
4.2.5	Protective devices	20
4.2.6	Backfeed protection	20
4.2.7	External battery cabinet installation (Trimod MCS BATTERY)	24
4.2.8	Mains connection	28
4.2.9	Bypass input line connection	29
4.2.10	Output line connection	29
4.3	Wiring diagrams	30
4.3.1	Factory configuration Trimod MCS 3-5-7: SINGLE PHASE input - SINGLE PHASE output	30
4.3.2	Factory configuration Trimod MCS 10-15-20-30-40-60-80: THREE PHASE input – THREE PHASE output with common bypass input line	31
4.3.3	THREE PHASE input - THREE PHASE output connection with separate bypass input line	32
4.3.4	THREE PHASE input – SINGLE PHASE output connection	33
4.3.5	SINGLE PHASE input - SINGLE PHASE output connection	34
4.3.6	SINGLE PHASE input - THREE PHASE 120° output connection	36
4.3.7	SINGLE PHASE input - THREE INDEPENDENT PHASE output connection	37
4.3.8	Installation of the connection jumpers	38
4.3.9	ARBC (Auxiliary Remote Bypass Contact)	40
4.4	Insertion of power modules and battery drawers	40
<b>5</b>	<b>Configuration and Start-up</b>	<b>41</b>
5.1	Introduction	41
5.2	Input configuration	41
5.3	Output configuration	41
5.4	Pre-start-up checks	41
5.5	Start-up procedure	42



---

<b>6</b>	<b>Maintenance</b>	<b>45</b>
6.1	Introduction	45
6.2	Preventive maintenance	45
6.3	Periodical checks	45
6.4	Ordinary maintenance	46
6.4.1	Maintenance procedure with EPS off	46
6.4.2	Maintenance procedure for the EPS in maintenance bypass mode	46
6.5	Battery drawers requirements	48
6.5.1	Installation/replacement of battery drawers with EPS in normal mode	49
6.5.2	Installation/replacement of battery drawers with EPS in maintenance manual bypass	49
6.6	Extraordinary maintenance	49
<b>7</b>	<b>Warehousing</b>	<b>50</b>
7.1	EPS	50
7.2	Batteries	50
<b>8</b>	<b>Dismantling</b>	<b>51</b>
8.1	Battery disposal	51
8.2	EPS dismantling	51
8.3	Electronic component dismantling	51
<b>9</b>	<b>Technical data</b>	<b>52</b>
<b>10</b>	<b>Tables</b>	<b>57</b>
<b>11</b>	<b>Wiring Diagrams</b>	<b>61</b>
11.1	Block diagram of interconnections and distributions of the EPS	61

---

## 1. Introduction



### **CAUTION**

The instructions in this manual are intended for a **SKILLED TECHNICIAN** (paragraph 2.2.1).  
Once the EPS has been installed, the skilled technician must not leave this manual at the operator's disposal.

### **1.1 Purpose of the manual**

The purpose of this manual is to provide the skilled technician (see paragraph 2.2.1) with instructions for safely installing the TRIMOD MCS EPS, also called "equipment" in the rest of the manual, and carry out ordinary maintenance procedures.

Any adjustments and extraordinary maintenance operations are not dealt with in this manual because they are the sole preserve of LEGRAND's Technical Support Service.

The reading of this manual is essential but does not substitute the skill of the technician who must have received adequate preliminary training.

The intended use and configurations envisaged for the equipment and shown in this manual are the only ones allowed by the Manufacturer. Any other use or configuration must be previously agreed with the Manufacturer in writing and, in this case, the written agreement will be attached to the installation and user manual.

This manual also makes reference to laws, directives and standards that the skilled technician is required to be aware of and consult.

The original text of this publication, drafted in Italian, is the only reference for the resolution of disputes of interpretation linked to translations into other languages.

### **1.2 Symbols in the manual**

Some operations are shown in graphic symbols that draw the attention of the reader to the danger or the importance they imply:



### **DANGER**

This indication shows a danger entailing a high degree of risk that, if not avoided, will lead to death or serious injury or considerable damage to the equipment and the things around it.



### **WARNING**

This indication shows a danger entailing a medium degree of risk that, if not avoided, could lead to death or serious injury or considerable damage to the equipment and the things around it.



### **CAUTION**

This indication shows a danger entailing a low level of risk that, if not avoided, could lead to minor or moderate injury or material damage to the equipment and the things around it.

### **INDICATION**

This symbol indicates important information which should be read carefully.

### 1.3 Where and how to keep the manual

This manual must be kept in a safe, dry place and must always be available for consultation exclusively by the skilled technician.

It is recommended to make a copy of it and file it away.

If information is exchanged with the Manufacturer or the authorised assistance personnel, it is essential to refer to the equipment's rating plate data and serial number.

#### **INDICATION**

**The supplied manuals are an integral part of the equipment and must therefore be kept for their entire lifetime.**

In case of need (for example in case of damage that even partially compromise the consultation) the skilled technician is required to get a new copy from the Manufacturer, quoting the publication code on the cover.

### 1.4 Update of the manual

The manual reflects the state of the art when the equipment was put onto the market. The publication conforms with the standards current on that date. The manual cannot be considered inadequate when new standards come into force or modifications are made to the equipment.

Any addition to the manual the Manufacturer considers appropriate to send to the users, must be kept together with the manual of which they will become an integral part.

The updated version of the manual is available on the Internet at <http://www.ups.legrand.com>

### 1.5 Manufacturer's liability and guarantee

The skilled technician and the operator shall scrupulously comply with the precautions indicated in the manuals. In particular they must:

- always work within the operating limits of the equipment;
- always carry out constant and careful maintenance through a skilled technician who complies with all the procedures indicated in the installation and maintenance manual.

The Manufacturer declines all indirect or direct responsibility arising from:

- installation and wiring completed by personnel not possessing the qualifications required by the regulations of the country of installation for working on equipment operating on dangerous voltages;
- installation and wiring completed by personnel not wearing the Personal Protective Equipment required by the regulations of the country of installation;
- failure to observe the installation, maintenance instructions and use of the equipment which differs from the specifications in the user manual;
- use by personnel who have not read and thoroughly understood the content of the user manual;
- use that does not comply with the specific standards used in the country where the equipment is installed;
- modifications made to the equipment, software, functioning logic unless they have been authorised by the Manufacturer in writing;
- repairs that have not been authorised by the LEGRAND Technical Support Service;
- damage caused intentionally, through negligence, by acts of God, natural phenomena, fire or liquid infiltration.
- damage caused by the use of batteries or protections other than those indicated in the installation and maintenance manual;
- damage caused by failure to install or establish the safety protections indicated in the manuals, or by failure to comply with the safety labels.

Transfer of the equipment to others also requires the handing over of all the manuals. Failure to hand over the manuals shall automatically nullify any right of the buyer, including the terms of the guarantee where applicable.

If the equipment is sold to another party in a country where a different language is spoken, the original owner shall be responsible for providing a faithful translation of the manuals in the language of the country where the equipment will be used.

#### 1.5.1 Guarantee terms

The terms of the guarantee may vary depending on the country where the EPS is sold. Check the validity and duration with LEGRAND's local sale representative.

If there should be a fault in the equipment, contact the LEGRAND Technical Support Service which will provide all the instructions on what to do.

## 1. Introduction

**Do not send anything back without LEGRAND's prior authorization.**

**The guarantee becomes void if the EPS has not been brought into service by a properly trained skilled technician (see paragraph 2.2.1).**

If during the guarantee period the equipment does not conform with the characteristics and performance laid down in this manual, LEGRAND at its discretion will repair or replace the EPS and relative parts.  
All the repaired or replaced parts will remain LEGRAND's property.

LEGRAND is not responsible for costs such as:

- losses of profits or earnings;
- losses of equipment, data or software;
- claims by third parties;
- any damage to persons or things due to improper use, unauthorized technical alterations or modifications;
- any damage to persons or things due to installations where the full compliance with the standard regulating the specific usage applications have not been guaranteed.

### 1.6 Copyright

The information contained in this manual cannot be divulged to third parties. Any partial or total duplication of the manual which is not authorised in writing by the Manufacturer, by photocopying or other systems, including by electronic scanning, violates copyright conditions and may lead to prosecution.

**LEGRAND reserves the copyright of this publication and prohibits its reproduction wholly or in part without previous written authorisation.**

## 2. Regulatory and safety requirements



### DANGER

Before carrying out any operation on the equipment, it is necessary to read the entire manual carefully, especially this chapter.

Look after this manual carefully and consult it repeatedly during installation and maintenance by a skilled technician.

### 2.1 General notes

The equipment has been made for the applications given in the manuals. It may not be used for purposes other than those for which it has been designed, or differently from those specified.

The various operations must be carried out according to the criteria and the chronology described in this manual.

### 2.2 Definitions of "Skilled Technician" and "Operator"

#### 2.2.1 Skilled Technician

The professional figure who will carry out the installation, start up and ordinary maintenance is called "Skilled Technician". This definition refers to people who have specific technical qualification and are aware of the method of installing, assembling, repairing, commissioning and safe use of the equipment.

In addition to the requirements listed in the paragraph below for general operators, the Skilled Technician must be qualified in accordance with the safety regulations in force in the country of installation on the measures to implement when working in presence of hazardous voltage. He must also use the Personal Protective Equipment required by the safety regulations in force at the country of installation for all the activities indicated in the installation and maintenance manual (see paragraph 2.3)



### WARNING

The safety manager is responsible for protection and company risks prevention according to what is indicated in the European directives 2007/30/EC and 89/391/EEC regarding safety in the workplace.

The safety manager must ensure that all the people working on the equipment have received all the instructions included in the manuals with particular reference to those contained in this chapter.

#### 2.2.2 Operator

The professional figure assigned to the equipment for normal use is called "Operator".

This definition refers to people who know how to operate the equipment as described in the user manual and have the following requisites:

1. technical education, which enables them to operate according to safety standards in relation to the dangers linked to the presence of electric current;
2. training on the use of Personal Protective Equipment and basic first aid interventions.

The company safety manager, in choosing the person (operator) who uses the equipment, must consider:

- the person's work fitness according to the laws in force;
- the physical aspect (not disabled in any way);
- the psychological aspect (mental stability, sense of responsibility);
- the educational background, training and experience;
- the knowledge of the standards, regulations and measures for accident prevention.

He should also impart training in such a way as to provide thorough knowledge of the equipment and its component parts.

The operator shall consult the user manual at any time. He shall also follow the requirements provided to achieve maximum safety for himself and others during all operating phases.

Some typical activities the operator is expected to carry out are:

- the use of the equipment in its normal functioning state and the restore of the functioning after it shuts down;
- the adoption of the necessary provisions for maintaining the quality performance of the EPS;
- the cleaning of the equipment;
- cooperation with personnel responsible for ordinary maintenance activities (skilled technicians).

## 2. Regulatory and safety requirements

### 2.3 Personal Protective Equipment



The equipment poses a considerable risk of electric shock and a high short circuit current. During use and maintenance operations, it is forbidden to operate without the equipment listed in this paragraph.

People responsible for operating this equipment and/or passing close to it must not wear garments with flowing sleeves, nor laces, belts, bracelets or other metal pieces that might cause a danger.

The following signs sum up the Personal Protective Equipment to wear at all times. Additional requirements may be provided for by the safety regulations in force in the country of installation.



Anti-accident and no-spark shoes with rubber sole and reinforced toe



Safety gloves for protection from mechanical risks



Dielectric gloves for protection from dangerous voltages



Protective clothing for electrical work



Electrical protection helmet and visor



1000 V Insulated tools

### 2.4 Hazard signs in the workplace

The following signs must be exhibited at all points of access to the room where the equipment is installed:



Electric current

This sign indicates the presence of electrical live parts.



How to proceed in an emergency

Do not use water to quench fires but just the extinguishers specifically designed for putting out fires in electrical equipment.



No smoking

This sign indicates that smoking is not allowed.

### 2.5 Signs on the equipment

Displayed on the equipment are explanatory plates that can vary depending on the country the equipment is intended for and constructional standards applied.

Make sure the instructions are adhered to. It is strictly prohibited to remove these plates and to work in a way that differs from what is written there.

The plates must always be clearly read and they must be cleaned periodically.

If a plate deteriorates and/or it is no longer legible, even partially, the Manufacturer must be contacted for another one in order to replace it.

 **CAUTION**

The plates must not be removed or covered. No other plates may be affixed to the equipment without the Manufacturer's prior written authorisation.

 **WARNING**

Potential risks can be drastically reduced by wearing the Personal Protective Equipment listed in this chapter. These protections are indispensable. Always operate with due care around dangerous areas marked by the appropriate warning signs on the equipment.

**2.6 General warnings** **DANGER**

**The EPS works with dangerous voltages. Only SKILLED TECHNICIANS must perform the installation and ordinary maintenance operations. No part of the equipment can be repaired by the operator.**

Extraordinary maintenance operations must be carried out by LEGRAND Technical Support Service personnel.

 **DANGER**

Before beginning any installation and/or maintenance operation, make sure that all the DC and AC power sources are disconnected.

The EPS must be installed with an earth connection to avoid high leakage currents. First connect the earthing cable. Check during each installation and/or maintenance operation the continuity of the earthing system.

 **DANGER**

The EPS is powered by its own DC energy source (batteries). The output terminals may have a dangerous voltage even if the EPS is not connected to the AC power network.

The DC power source could comprise multiple battery drawers in parallel and/or external battery units. Disconnect all battery drawers and external battery units before performing any installation and/or maintenance operation.

 **WARNING**

A battery can present a risk of electrical shock and high short circuit current. The following precautions should be observed when working on batteries:

- a) remove watches, rings or other metal objects;
- b) use tools with insulated handles;
- c) wear rubber gloves and boots;
- d) do not lay tools or metal parts on top of batteries;
- e) disconnect the charging source prior to connecting or disconnecting battery terminals;
- f) determine if battery is inadvertently grounded. If inadvertently grounded, remove source from ground. Contact with any part of a grounded battery can result in electrical shock. The likelihood of such shock can be reduced if the ground connections are removed during installation and maintenance (applicable to remote equipment and battery supplies without a grounded supply circuit).
- g) never leave powered cables uncovered.

Do not dispose of batteries in a fire. The batteries may explode.

Do not open or mutilate batteries. Released electrolyte is harmful to the skin and eyes.

The batteries installed inside the cabinet must be disposed of correctly. For the disposal requirements refer to local laws and relevant standards.

 **CAUTION**

The EPS works with TT and TN systems. It has a pass-through neutral architecture: the status of the output neutral is the same as the input neutral. When the output load needs a different neutral status from the input status, it is necessary to place downstream of the equipment a suitably scaled isolation transformer protected in compliance with the standards in force.

Due to the high leakage current to ground, Trimod MCS cannot be powered by an IT system. It can only be used in an IT system if the IT transformer is connected downstream of the EPS.

## 2. Regulatory and safety requirements

### CAUTION

Do not open the battery fuse holders while the EPS is powering the loads in battery mode.

### WARNING

To reduce the risk of fire or electric shock, the equipment must work in clean and indoor environments with controlled temperature and humidity. It must be kept away from inflammable liquids and corrosive substances. The room temperature must not be above +40°C (+104°F) and the relative humidity must be a maximum of 95% not condensing.

### CAUTION

The equipment generates, uses and can radiate radio frequency energy. If it is not installed and used in accordance with the instructions in the manuals, it may cause harmful interference with radio communications.

Trimod MCS 3, 5, 7 and 10 are category C2 products according to standard EN62040-2.

In the home environment these devices could cause radio interference; in this case appropriate countermeasures must be taken.

All other Trimod MCS models are category C3 products according to standard EN62040-2.

They can therefore be used in commercial and industrial environments; nevertheless restrictions or adequate countermeasures might be necessary to avoid radio interference.

The skilled technician must also:

- pass with a double turn, the cables connected to the backfeed terminals to a Fair-Rite toroid code 0431176451 made with T31 material, installed as close as possible to the clamps;
- pass the input cables through three EPCOS TDK toroids code B64290L699X35 made with T35 material;
- pass the output cables through two EPCOS TDK toroids code B64290L699X35 made with T35 material;

### CAUTION

- The equipment must be maintained and used according to the instructions written in the manuals
- The departmental manager must instruct the operating and maintenance personnel on the safe use and maintenance of the equipment.
- Only specifically-trained, highly skilled personnel are allowed access to the equipment order to perform maintenance. While the maintenance operation is being carried out, signs saying "Maintenance work in progress" must be affixed in the department in such a way that they can be easily seen from each and any access area.
- The connection of the equipment (and of any accessory devices) must always be perfectly grounded to discharge short-circuit currents and electrostatic voltages. The input voltage must correspond with the value shown on the rating plate. Current adapters must not be used under any circumstances. Pay attention to polarity when connecting.
- Any intervention on the equipment must be done only after it has been disconnected from the power supply network by means of a switch disconnecter and must be locked with an appropriate padlock.
- The EPS must not be turned on if liquid is leaking from the batteries.
- The equipment used for any maintenance operations (pliers, screwdrivers etc.) must be electrically insulated.
- Depositing flammable material near the equipment is strictly forbidden. The equipment should always be locked, and only specifically trained personnel are allowed access to them.
- Do not disable any safety, signalling or warning devices and do not ignore any alarms, warning messages or notices, no matter whether they are generated automatically or represented by plates fixed to the equipment.
- Do not run the equipment with fixed protections not installed (panels etc.).
- In case of breaking, buckling or malfunctioning of the equipment or parts of it, repair or replace immediately.
- For no reason can the equipment, the devices and the operation sequence, be modified, disabled or tampered with in any way, without prior consultation with the Manufacturer.
- When replacing fuses, only use ones of the same type.
- The replacement of the batteries is an operation intended to be carried out by a skilled technician.
- Keep a register in which to enter the date, time, type, performer's name and any other useful information about each and any routine- and extraordinary-maintenance operation.
- Do not use oils or chemical products for cleaning because they could scratch, corrode or damage certain parts of the equipment.
- The equipment and workplace must be kept completely clean.
- Upon completion of the maintenance operations, before connecting the power supply, carry out a careful check in order to make sure that no tools and/or material of any kind have been left next to the equipment.





**CAUTION**

The skilled technician must not leave at the disposal of the operator:

- the keys for opening the EPS door;
- the installation and maintenance manual.

**2.7 How to proceed in an emergency**

The following information are general.

For the specific interventions consult the regulations in force in the country where the equipment is installed.

**2.7.1 First-aid procedures**

When administering first aid, adhere to the company rules and the usual procedures.

**2.7.2 Fire procedures**

Do not use water to quench fires but just the extinguishers specifically designed for putting out fires in electrical equipment.

### 3. Unpacking and positioning

#### 3.1 Visual check

On delivery of the EPS, carefully inspect the packaging and the product for any damage that might have occurred during transport. Check there is no damage to the indicator on the outer label reading "Shock Watch".

If there is possible or ascertained damaged immediately inform:

- the transporter;
- the LEGRAND Technical Support Service.

Check the equipment corresponds with the material indicated in the delivery documentation.

Follow the instructions in Chapter 7 when storing the equipment.

#### 3.1.1 Equipment and supplied accessories check

The equipment and the relative supplied accessories must be a perfect state of repair.

Check that:

- the shipping data (address of the recipient, no. of packages, order no, etc.) correspond to what is contained in the delivery documentation;
- the technical rating plate data on the label applied to the EPS correspond with the material purchased, described in the delivery documentation;
- the documentation accompanying the equipment includes the installation manual and the user manual.

Should any of these be different from what they should be, immediately inform the LEGRAND Technical Support Service before commissioning the equipment.

#### 3.2 Unpacking

To remove the packing material, follow the graphic indications on the outer box and the following procedure:

1. Cut the plastic safety straps from the packaging

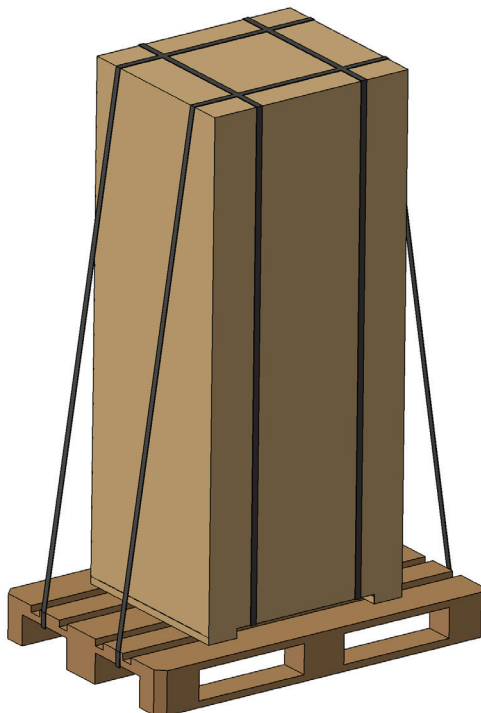

2. Open the top of the packaging and take out the accessory box

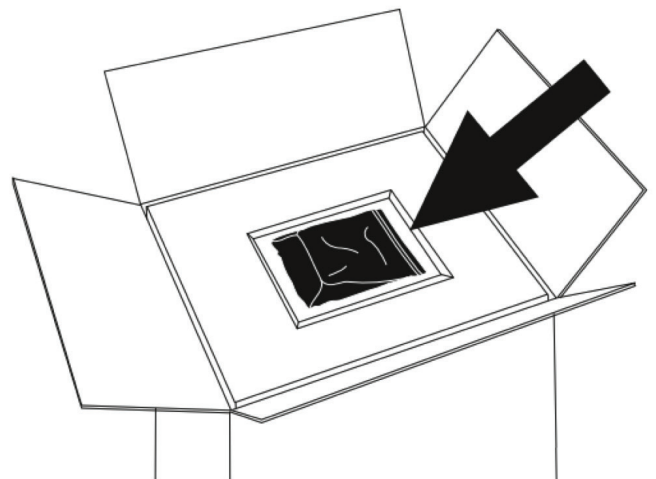

3. Remove the packing carton from the UPS by sliding it upward

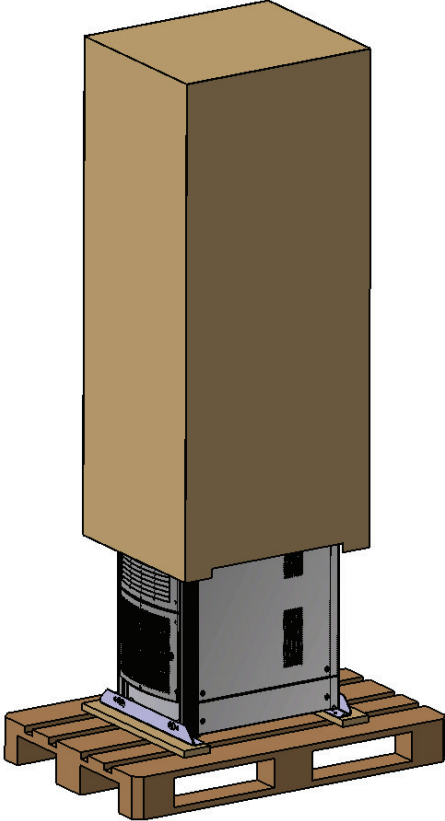

4. Remove the pallet

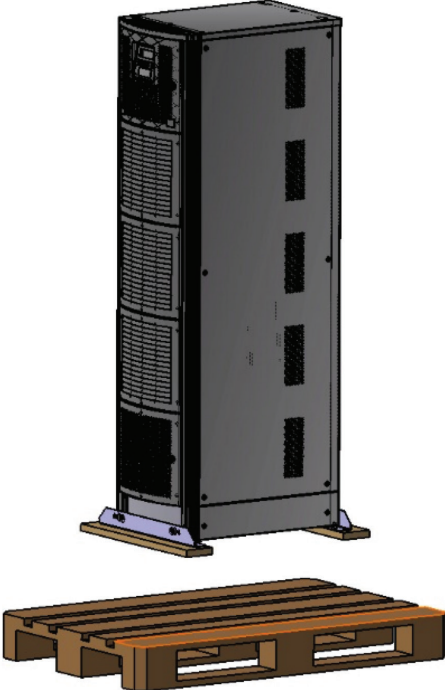

5. Remove the front and rear brackets from the UPS by unscrewing the retaining screws

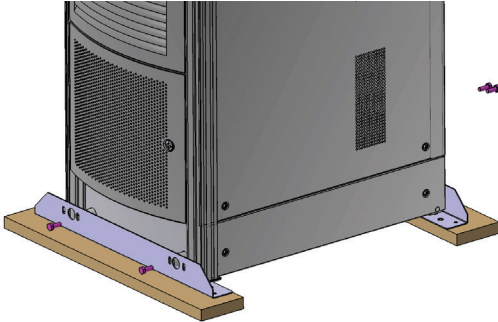

6. Remove the brackets

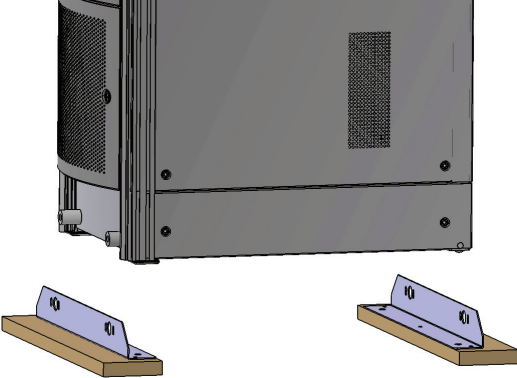

7. Inspect the UPS for damage. Notify the carrier and supplier immediately if there is any apparent damage. Save the packing materials for possible future shipments.

---

## 3. Unpacking and positioning

### **WARNING**

Move the UPS very carefully, lifting it as little as possible and avoiding dangerous swings or falls. The equipment must always be handled by trained and instructed personnel equipped with the Personal Protective Equipment illustrated in chapter 2.

Do not move the UPS after installation or following the insertion of power modules and any battery drawers.

The Trimod HE UPS has wheels at the back of the cabinet. Before installation and while it is still empty, it can be moved by hand by at least two people.

For any lifting, use a forklift or a transpallet with an adequate carrying capacity, placing the forks in the wooden base and making sure they come out the other side by at least twenty centimeters.

### 3.3 Check of the content

The content of the supply is subject to thorough checking before the shipment. Nonetheless it is always advisable to check that it is complete and in order on receiving the material.

The following list is general:

- 1 Trimod MCS EPS;
- 1 envelope of accessories containing washers for the contact with the earthing, set of screws for fitting the panels, two eight-pole terminal strips, a serial cable and fuses (the latter are only included in models with internal batteries);
- 1 envelope of accessories containing one or more EC15 connectors according to the model and connecting jumpers for the terminal strip (ONLY for Trimod MCS 10, 15, 20 and 30);
- 1 front closing panel;
- 2 base strips for side closing;
- user manual and installation and maintenance manual;
- acceptance report.

Should there be defects and/or missing material, immediately inform the LEGRAND Technical Support Service before commissioning the equipment.

### **CAUTION**

**The installation manual must be used and consulted only by SKILLED TECHNICIANS.**

### **INDICATION**

In case of purchase of empty cabinets, the power modules and any battery drawers to install must be bought separately.

### 3.4 Movement

### **WARNING**

Move the EPS very carefully, lifting it as little as possible and avoiding dangerous swings or falls.

The equipment must always be handled by trained and instructed personnel equipped with the Personal Protective Equipment illustrated in chapter 2.

The EPS has wheels at the back of the cabinet. Before installations, and while it is still empty, it can be moved by hand by at least two people.

For any lifting, use a forklift or a transpallet with an adequate carrying capacity, placing the forks in the wooden base and making sure they come out the other side by at least twenty centimetres.

### **WARNING**

Do not move the equipment after installation or following the insertion of power modules and any battery drawers.

### 3.5 Positioning constraints

Minimum recommended distances for the EPS  
X=100 mm / Y=200 mm

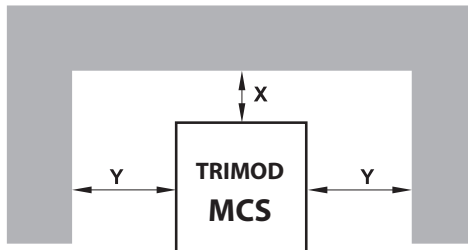

Minimum recommended distances Trimod MCS + Trimod MCS BATTERY  
X=100 mm / Y=200 mm

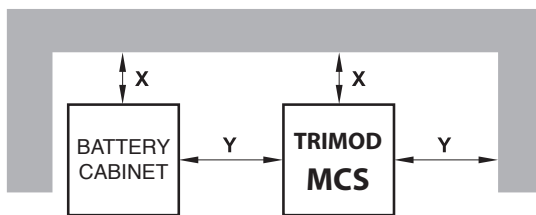

- The EPS must be positioned respecting the following conditions:
- temperature and humidity must be within permitted limits;
  - fire regulations must be respected;
  - the wiring must be simply made;
  - front and rear accessibility must be available for assistance or periodic servicing;
  - the cooling flow of air must be guaranteed;
  - the air conditioning system must be adequately scaled;
  - dust or corrosive/explosive gasses must be absent;
  - the premises must be free of vibration;
  - the rear and side space must be enough to guarantee an adequate circulation of air for cooling;
  - the support surface must be scaled in for the carrying capacity necessary to support the equipment.

To safeguard the batteries as well as possible it is necessary to bear in mind that their average lifetime is strongly influenced by the operating room temperature. Position the equipment in an environment with a temperature range between +20°C (+68°F) and +25°C (+77°F) to guarantee the optimum life of the batteries.

Before proceeding with the installation operations, make sure that there is enough lighting to clearly see every detail. Provide artificial lighting if the natural lighting does not satisfy the requirements cited. In the case of maintenance operations in places that are not sufficiently well lit, portable lighting systems must be used.

### 3.6 Final operations

Once the EPS has been properly positioned, fit the two base strips and the front one provided in the accessory kit.

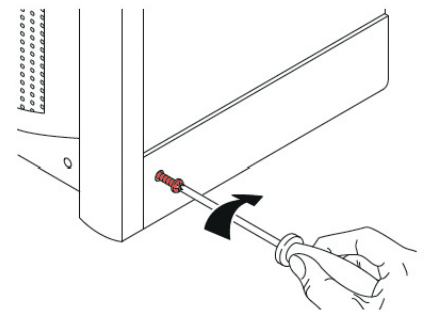

## 4. Installation



All the installation operations must be carried out exclusively by a SKILLED TECHNICIAN.

### 4.1 Safety regulations



Before carrying out any installation operation you must read and apply the following:

1. The EPS has a high leakage current. It is essential to make the earth connection before connecting the power supply. It is necessary to make sure that the switchgear has a safe connection with the earth circuit and adequate protection as required by the installation standards.
2. The equipment must only be installed in a fixed way with a thermal-magnetic circuit breaker placed upstream of it. Connection to the mains via traditional type plug is not allowed.
3. A circuit to protect from voltage backfeed made as in the diagrams shown in paragraph 4.2.6 must be provided outside the EPS.
4. The switchgear or the disconnecter must be installed near the equipment and must be easily accessible.
5. A warning label must be placed on all the mains disconnecter switches installed away from the area of the equipment for the purpose of reminding the assistance personnel of the fact that the circuit is connected to a EPS. The label must bear the following text (or the equivalent):

**Before working on this circuit**

- Isolate the Emergency Power System (EPS)
- Then check for the presence of Hazardous Voltage between all terminals including the protective earth.



**Risk of Voltage Backfeed**

### 4.2 Electrical connections

The electric hook-up of the equipment to the switchgear is part of the installation that is not normally performed by the manufacturer; for this reason, the indications that follow are to be considered approximate and it is recommended that the electric connections are made on the basis of local installation standards.

After removing the EPS from the packaging and positioning it in its definitive place, the skilled technician can begin to make the electric connections.



The choice of cable type and their cross sections depending on the current they carry and their installations must be made as indicated by the installation standards in force and it is a responsibility of the skilled technician. The input current and the output power of the EPS are indicated in chapter 9 and the battery current in table 8 of chapter 10.

#### INDICATION

Chapter 10 shows the instructions for sizing cables, fuses and automatic/residual current breakers.

#### 4.2.1 Safety warnings



Before proceeding with the operations it is necessary to read and apply what is reported below. Proceeding with the operations if one or more of the following conditions have not been met is prohibited.

- Do not carry out the installation if there is water or humidity around.
- Do not open or remove the EPS panels.
- Check there is no mains voltage on the equipment.
- Check that the loads are off and disconnected from the EPS.
- Check the EPS is off and no voltage is present.

- The connecting terminals have a maximum torque depending on the model:
  - Trimod MCS 3-5-6-10-15-20: 4.5 Nm
  - Trimod MCS 30: terminals 8 Nm, battery terminals 3 Nm.
  - Trimod MCS 40-60-80: terminals 4.5 Nm, battery terminals 9 Nm.
- The connection cables to be used must have a maximum operating temperature of at least 70°C.
- Check that the battery breakers on the EPS (if present) and on all external battery cabinets, if there are any installed, are open.

All the electrical connection operations are carried out on the connection terminal strips inside the equipment. For the Trimod MCS 3, 5, 7, 10, 15, 20 models, it is necessary to unscrew the distribution drawer locking screws and pull it outward to get at the distribution terminal strip. For the Trimod MCS 30, 40, 60 and 80 models, it is necessary to remove both the lower panels to get at the terminal distribution strip.

Outside the drawer there are the fuse breakers (depending on the model), the output switch, the mains input switch, the bypass input switch and the manual maintenance bypass switch.

#### 4.2.2 Preliminary operations

Before connecting the EPS, check that:

- the mains input voltage and frequency correspond with the values indicated in the technical data on the rating plate;
- the earthing has been carried out in compliance with IEC (International Electrotechnical Commission) standards or local regulations;
- the electrical system has been fitted with the necessary differential and thermal-magnetic protections upstream of the equipment input.

#### 4.2.3 Wiring

For all the models, it is possible to pass the cables from underneath, through the opening at the base. For the models of Trimod MCS from 3 kVA to 60 kVA, it is also possible to pass the cables from the metal plate fixed to the rear panel by means of four screws. In this case it is necessary to lock the cables in place with appropriate cable glands, not supplied, to be inserted in the holes of the plates. The plates have four holes 33 mm in diameter and one hole 16 mm in diameter.

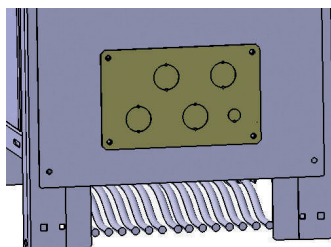

In the case of the Trimod MCS 80, the cables must be passed into the opening at the base. The fastening is done on the appropriate bar by means of clamps and clips present in one of the accessory packs.

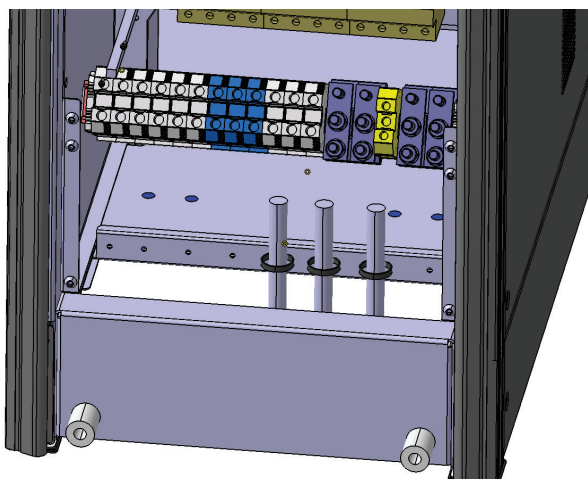

## 4. Installation

### 4.2.4 Earthing

Before carrying out any other installation operation, connect the earthing wiring coming from the low voltage switchgear to the earthing terminal on the EPS terminal strip.

In the case of the Trimod MCS 80, the earthing cables must be connected via cable lugs in the 8mm threaded holes on the base, as shown in the following image:

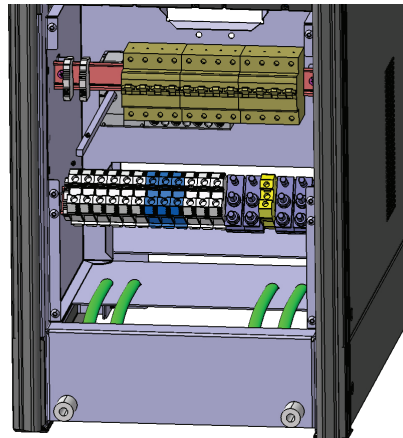

### 4.2.5 Protective devices

Adequate protection must be used at electrical system level to ensure the correct operation of the EPS and protect it against overloads or output short circuits.

Install automatic differential and thermal-magnetic circuit breakers upstream of the equipment on both the mains input line and the bypass input line (if separate). The circuit breakers must be sized according to the indications of the tables in Chapter 10.

### 4.2.6 Backfeed protection

The Trimod MCS is fitted with an auxiliary contact for the actuation of the external backfeed protection (protection against power transfer towards the input). This auxiliary contact has been created with a C/NC/NO relay and is available on the the relative tripolar "BACKFEED PROTECTION" terminal on the terminal strip.

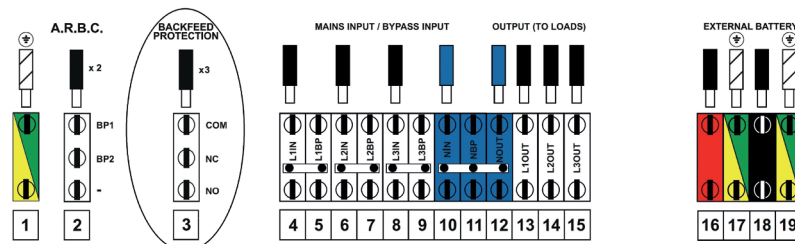

If the EPS detects a voltage backfeed, the relay is energised and changes status, enabling the disconnection of the input lines that must be done externally as indicated in the diagrams shown below.

The relay contacts characteristics are:

- Maximum applicable voltage: 250Vac.
- Maximum applicable current: 5A,  $\cos\phi = 1$

#### INDICATION

If, during operation, the equipment signals that the backfeed protection has been actuated, contact the LEGRAND Technical Support Service.



**TT or TN-S distribution system and backfeed protection circuit connection diagrams with bypass line in common with the mains input**

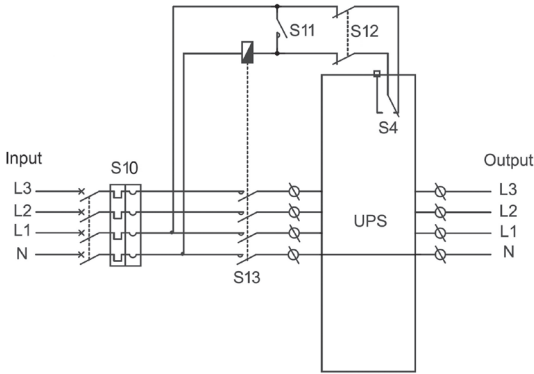

**Three phase/Three phase configuration**

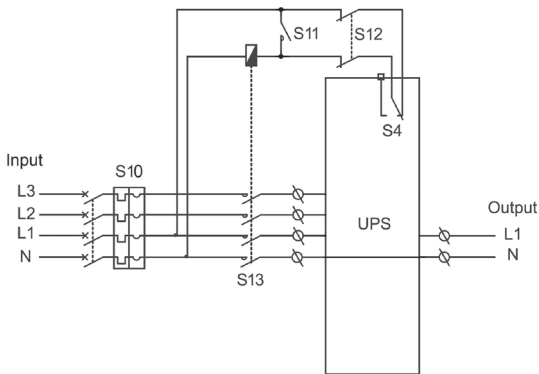

**Three phase/Single phase configuration**

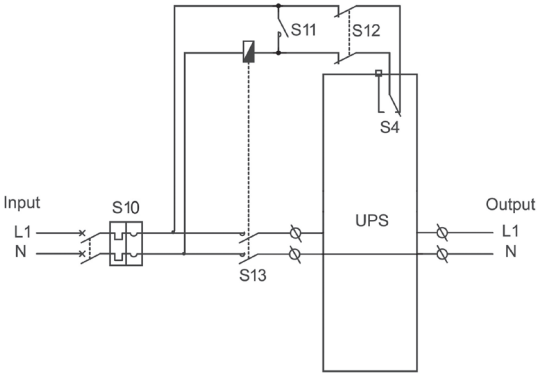

**Single phase/Single phase configuration**

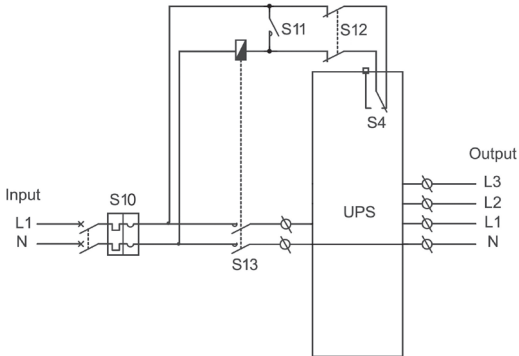

**Single phase/Three phase configuration**

- S10: thermal-magnetic/differential breakers specified for the input line
- S13: mains input line opening contactor
- S11: disconnector in parallel to the S13 contactor coil
- S12: two-pole disconnector in series to the line to the EC9 connector of the contact interface card
- S4: backfeed auxiliary contact

## 4. Installation

**TT or TN-S distribution system and backfeed protection circuit connection diagrams with a separate bypass line to the mains input**

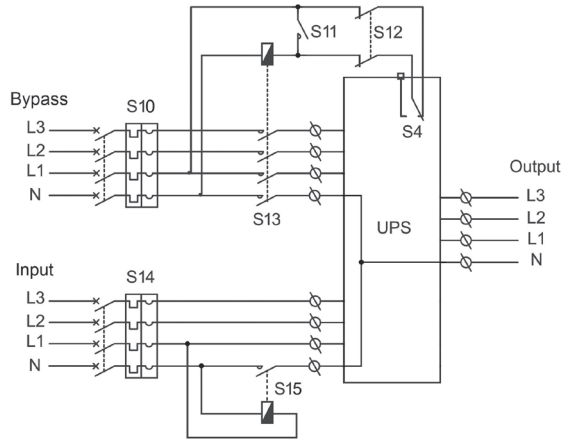

**Three phase/Three phase configuration**

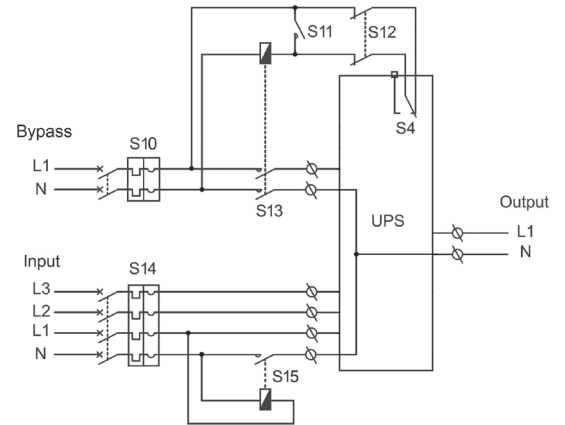

**Three phase/Single phase configuration**

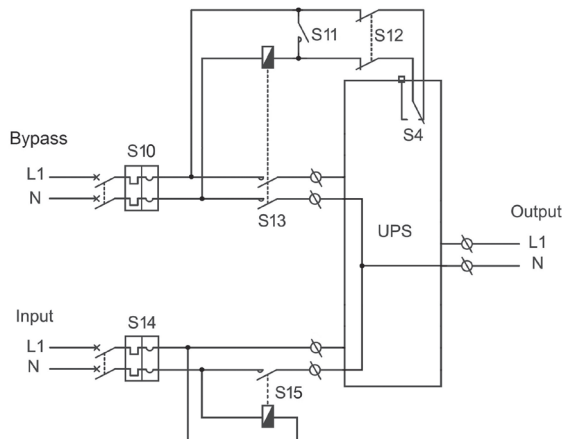

**Single phase/Single phase configuration**

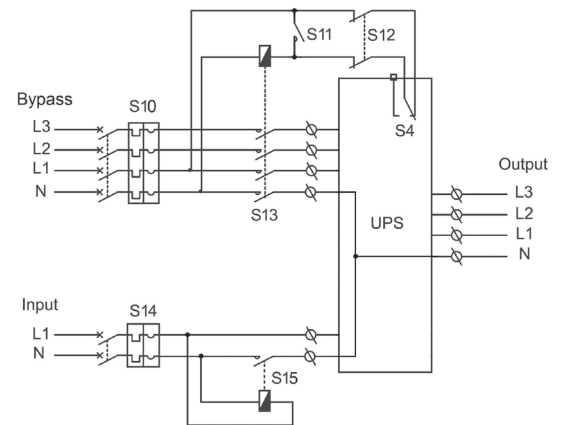

**Single phase/Three phase configuration**  
(available only for SINGLE PHASE input and THREE INDEPENDENT PHASES output)

- S10-S14: thermal-magnetic/differential isolation switches specified for the input line and the bypass line
- S13: bypass line opening contactor
- S15: mains input line neutral opening contactor
- S11: disconnector in parallel to the S13 contactor coil
- S12: two-pole disconnector in series to the line to the EC9 connector of the contact interface card
- S4: backfeed auxiliary contact

**TN-C distribution system and backfeed protection circuit connection diagrams with bypass line in common with the mains input**

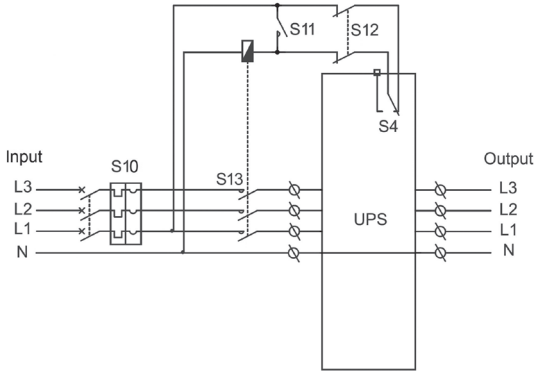

**Three phase/Three phase configuration**

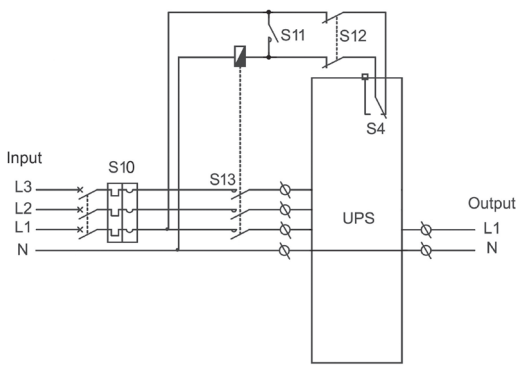

**Three phase/Single phase configuration**

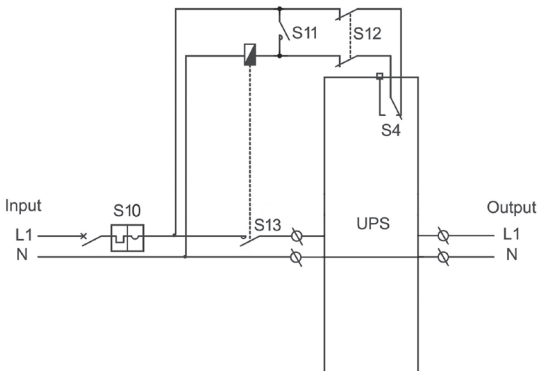

**Single phase/Single phase configuration**

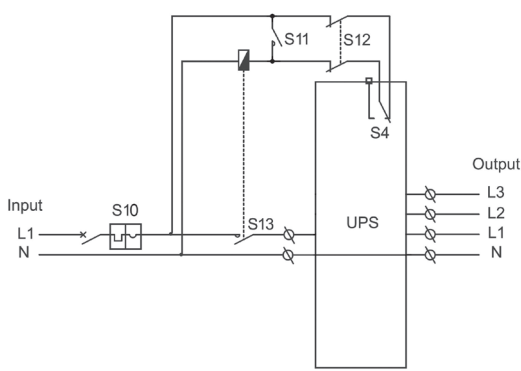

**Single phase/Three phase configuration**

- S10: thermal-magnetic/differential breakers specified for the input line
- S13: mains input line opening contactor
- S11: disconnector in parallel to the S13 contactor coil
- S12: two-pole disconnector in series to the line to the EC9 connector of the contact interface card
- S4: backfeed auxiliary contact

## 4. Installation

**TN-C distribution system and backfeed protection circuit connection diagrams with a separate bypass line to the mains input**

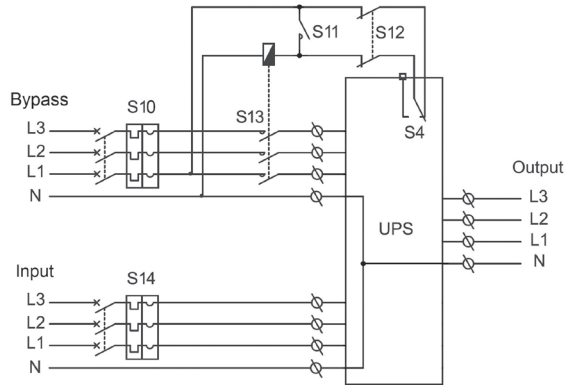

**Three phase/Three phase configuration**

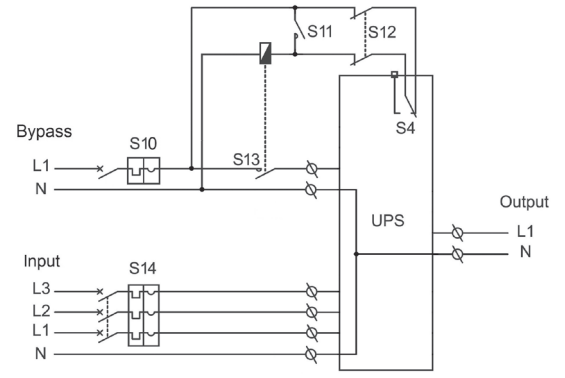

**Three phase/Single phase configuration**

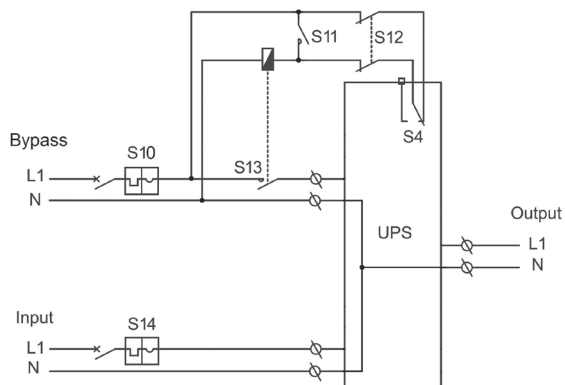

**Single phase/Single phase configuration**

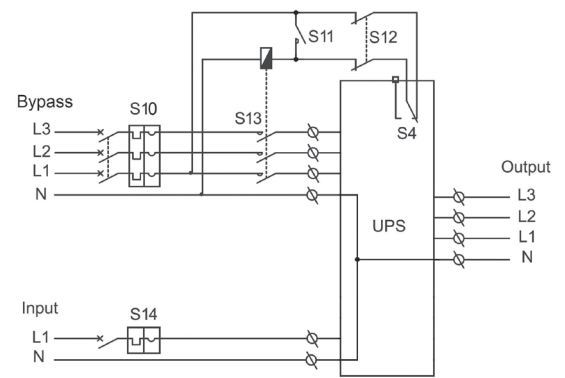

**Single phase/Three phase configuration**  
(available only for SINGLE PHASE input and THREE INDEPENDENT PHASES output)

- S10-S14: thermal-magnetic/differential isolation switches specified for the input line and the bypass line
- S13: bypass line opening contactor
- S11: disconnector in parallel to the S13 contactor coil
- S12: two-pole disconnector in series to the line to the EC9 connector of the contact interface card
- S4: backfeed auxiliary contact

### INDICATION

By protecting external backfeed protection as indicated in the diagrams, it is possible to disconnect the line from the outside and secure it. First switch on the S11 isolation switch in parallel to the contact coil and then switch off the S12 two-pole isolation switch in series to the line to the EC9 connector.

### 4.2.7 External battery cabinet installation (Trimod MCS BATTERY)

By installing external battery cabinets it is also possible to increase the autonomy of the EPS.

Three Trimod MCS BATTERY models are available:

- a modular model, consisting of a cabinet with an internal structure using battery drawers for a maximum of eighty 12V 9Ah batteries (16 drawers)
- a modular model, consisting of a cabinet with an internal structure using battery drawers for a maximum of one hundred 12V 9Ah batteries (20 drawers)
- a compact, non-modular model that on the other hand uses a shelf architecture that can house twenty 12V-94 Ah batteries inside.

**CAUTION**

1 KB (Battery Kit) represents a string of 20 batteries in series.

In case of models with internal battery drawers and for external modular battery cabinets, 1 KB comprises 4 battery drawers.

It is necessary to install 1 KB every 10 kVA of nominal EPS power in case of modular units with battery drawers.

For example, for the Trimod MCS 40 it is necessary to have at least one external modular battery cabinet with 4 KB (16 battery drawers).

In case of non-modular 94Ah external battery cabinets, each unit represents 1 KB and 1 KB is sufficient for all the Trimod MCS models.

**Connection of one external modular battery cabinet to the Trimod MCS 3-5-7-10-15-30**

The Trimod MCS MODULAR BATTERY 4KB-5KB must be connected to the Trimod MCS 3-5-7-10-15-30 with one of the multipolar cables provided with each battery cabinet.

**CAUTION**

Table 8 of chapter 10 includes instructions for sizing the cables to connect the EPS to the first external battery cabinet in case the multipolar cable provided is not used.

The maximum length of the connection cable between the equipment and the first external battery cabinet must not exceed 3 meters.

In case of configurations where there are more than one external battery cabinet, it is recommended to implement a battery switchboard as indicated in this paragraph under the subtitle "Connection of one or more external battery cabinets to the Trimod MCS".

The connection must be made according to the diagram and the passages indicated below:

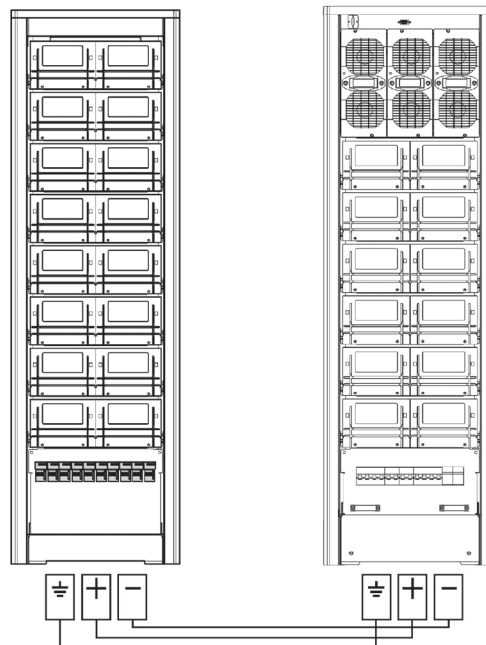

1. Check that all the battery fuse disconnectors are open.
2. Loose the screws that keep close the panel that gives access to the terminal strips of the external battery cabinet.
3. By using one of the multipolar cables provided with the external battery cabinet, connect the EPS to the external battery cabinet installed using the earthing wires (yellow-green).
4. By means of the multipolar cables used in the preceding point, connect the positive and negative terminals of the equipment with those of the external battery cabinet installed.
5. Refit the panel and tighten the screws.

## 4. Installation

### Connection of one external modular battery cabinet to the Trimod MCS 40

The Trimod MCS MODULAR BATTERY 4KB-5KB must be connected to the Trimod MCS 40 with both the multipolar cables provided with the battery cabinet.

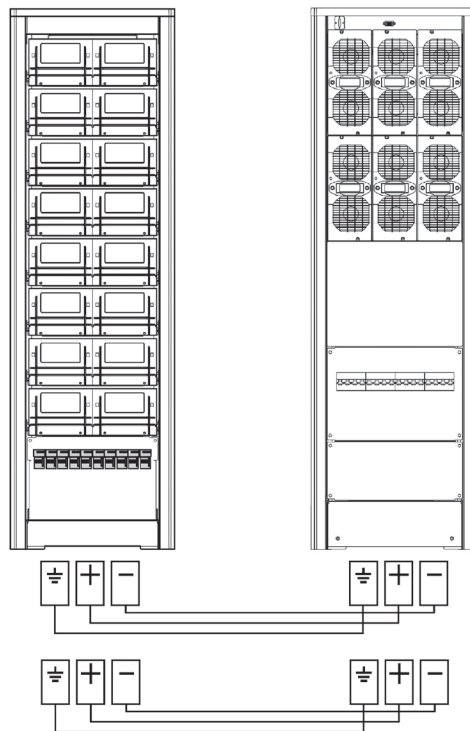

Table 8 of chapter 10 includes instructions for sizing the cables to connect the EPS to the first external battery cabinet in case the multipolar cable provided is not used.

The maximum length of the connection cable between the equipment and the first external battery cabinet must not exceed 3 meters.

In case of configurations where there are more than one external battery cabinet, it is recommended to implement a battery switchboard as indicated in this paragraph under the subtitle "Connection of one or more external battery cabinets to the Trimod MCS".

The connection must be made according to the diagram and the passages indicated below:



1. Check that all the battery fuse disconnectors are open.
2. Loose the screws that keep close the panel that gives access to the terminal strips of the external battery cabinet.
3. By using both the multipolar cables provided with the external battery cabinet, connect the EPS to the external battery cabinet installed using the earthing wires (yellow-green).
4. By means of the multipolar cables used in the preceding point , connect the positive and negative terminals of the equipment with those of the external battery cabinet installed.
5. Close the panel and tighten the screws.

### Connection of two external modular battery cabinets to the Trimod MCS 60

A Trimod MCS 60 can only be connected to two TRIMOD MCS MODULAR BATTERY 5 KB (20 battery drawers) using exclusively external cables as per the instructions provided in table 8 of chapter 10.

The multipolar cables provided with each battery cabinet must only be used for the cascade connection of the first external battery cabinet to the second.



#### CAUTION

The maximum length of the connection cables between the EPS and the first external battery cabinet must not exceed 3 meters.

It is not possible to connect only one TRIMOD MCS BATTERY 5KB to the Trimod MCS 60.

The external battery cabinets must be homogeneous in the number of battery drawers. The difference between one cabinet and the other must be a maximum of 1 KB (4 battery drawers).

For the connection of two or more external battery cabinets, it is recommended to implement a battery switchboard as indicated in this paragraph under the subtitle "Connection of one or more external battery cabinets to the Trimod MCS".

The cascade connection of the two external battery cabinets must be made according to the diagram and the passages indicated below:

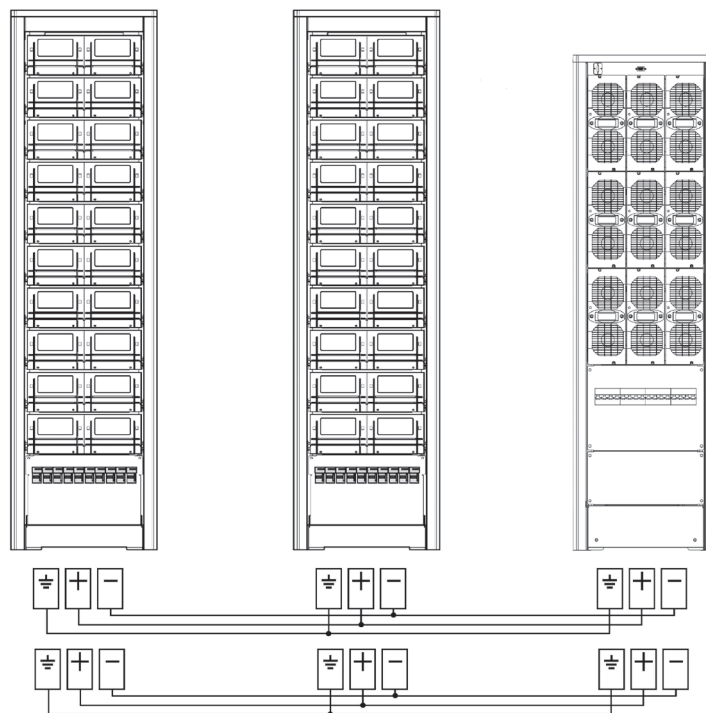

1. Check that all the battery fuse disconnectors are open.
2. Loose the screws that keep close the panel that gives access to the terminal strips of the external battery cabinets.
3. Connect the EPS and the first external battery cabinet installed using an earthing (green/yellow) cable.
4. By means of two cables with minimum cross-section indicated in table 8 of chapter 10, connect the positive and negative terminals of the EPS with those of the first external battery cabinet installed.
5. Connect the first external battery cabinet with the second using both the multipolar cables provided by connecting the earthing cable first and then the positive and negative terminals.
6. Close the panel and tighten the screws.

### Connection of the external modular battery cabinets to the Trimod MCS 80

It is not possible to connect the external modular battery cabinets to the Trimod MCS 80 EPS.

It is only possible to connect the non modular model with 12V-94Ah batteries. For the connection, it is necessary to use the external cables according to the instructions given in table 8 of chapter 10.

## 4. Installation

### Connection of one or more external non-modular battery cabinets to the Trimod MCS

It is possible to connect to the non-modular model with 12V-94Ah batteries to the Trimod MCS 20, 30, 40, 60 and 80. For the connection, it is necessary to use the external cables according to the instructions given in table 8 of chapter 10. It is recommended to implement a battery switchboard as indicated in this paragraph under the subtitle "Connection of one or more external battery cabinets to the Trimod MCS".

### Connection of one or more external battery cabinets to the Trimod MCS

If the EPS must be connected to one or more external battery cabinets, it is recommended to implement a battery switchboard as indicated below:

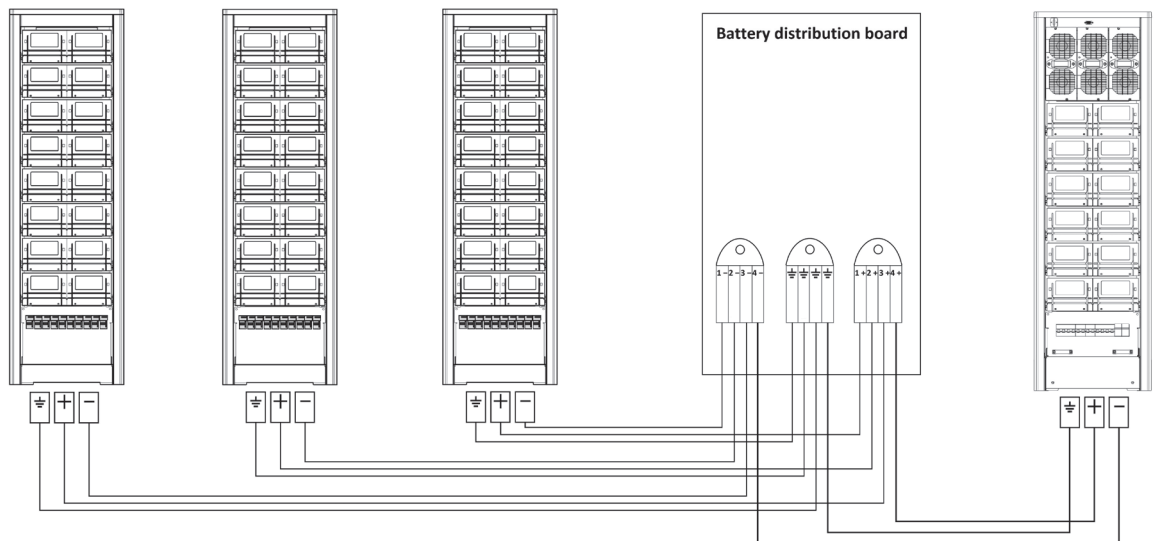

The external modular battery cabinets must be connected to the switchgear with the multi-polar cables provided. The external non-modular battery cabinets must be connected to the external cables according to the instructions given in table 8 of chapter 10.



#### CAUTION

Different connection solutions are the sole responsibility of the installer.

The implementation of the battery switchboard must be carried out according to the local installation regulations and it is a responsibility of the installer.

The length of the connection cable between the EPS and the switchboard must not exceed 3 meters.

The external modular battery cabinets must be homogeneous in the number of battery drawers. The difference between one cabinet and the other must be a maximum of 1 KB (4 battery drawers).

#### INDICATION

Table 8 of chapter 10 shows the sizing of the cables for connecting the EPS to the battery switchboard.

The input current and the output power of the EPS are indicated in chapter 9 and the battery current in table 8 of chapter 10.

Tables 3 and 4 of chapter 10 provide information to size the fuses to be installed in the external modular battery units.

Table 5 of chapter 10 provides information to size the fuses to be installed in the battery switchboard for the connection to the EPS.

### 4.2.8 Mains connection

Before connecting the input power supply cables, check that all the EPS switches are open (OFF position) and arrange the connection jumpers on the terminal strip according to the requested input-output configuration.

#### INDICATION

Chapter 10 shows the instructions for sizing cables, fuses, automatic and differential breakers.

The default configuration is SINGLE-PHASE INPUT and SINGLE-PHASE OUTPUT for Trimod MCS 3-5-7 and THREE PHASE INPUT and THREE PHASE 120° OUTPUT for Trimod MCS 10-15-20-30-40-60-80.



If this type of distribution is used, the connection jumpers are correctly sized and positioned. For different configurations, it is necessary to consult paragraph 4.3 that includes the connection diagrams and chapter 5.

The connection must be made according to the passages indicated below:

- Before beginning to connect the mains, check that the available mains power is more than or the same as the nominal EPS input power.
- Check that the cables to connect to the equipment are isolated upstream and no voltage is present.
- Check that the earth cable from the low voltage switchgear panel is connected to the appropriate terminal, or secured to the base of the EPS (in case of Trimod MCS 80).
- Connect the mains input neutral cable to the Nin mains input terminal.
- Connect cables L1, L2 and L3 of the mains input line to the L1in, L2in and L3in terminals, being careful to observe the phase sequence (L1, L2, L3).



#### **WARNING**

The neutral input cable must ALWAYS be connected otherwise the EPS may be damaged irreparably once powered from the mains.

#### **4.2.9 Bypass input line connection**

The default configuration has the bypass line in common to the mains input.

A separate bypass line can only be connected if the bypass and mains input neutral cables are in common (same potential) and the two supply lines must always have a single differential circuit breaker, if provided. The EPS has the mains, bypass and output passing neutral and they are connected internally to each other.

#### **INDICATION**

Chapter 10 shows the instructions for sizing cables, fuses, automatic and differential breakers.

For the configuration of a separate bypass input line, refer to paragraph 4.3, which includes the connection diagrams, and chapter 5 for configuration with separate bypass input line.

The connection must be made according to the passages indicated below:

- Before beginning to connect the bypass line, check that the available mains power is more than or the same as the nominal EPS input power.
- Check that the cables to connect to the equipment are isolated upstream and no voltage is present.
- Connect the earth cable of the bypass line to the appropriate terminal, or secure it to the base of the EPS (in case of Trimod MCS 80).
- Connect the bypass line neutral cable to the appropriate Nbyb bypass input terminal.
- Remove the three jumpers linking terminals L1in, L2in, L3in and L1byb, L2byb, L3byb.
- Connect cables L1, L2 and L3 of the bypass input line to the L1byb, L2byb and L3byb bypass input terminals, being careful to observe the phase sequence (L1, L2, L3).



#### **WARNING**

The neutral cable of the separate bypass mains must ALWAYS be connected otherwise the EPS may be damaged irreparably once powered from the mains.

#### **4.2.10 Output line connection**

Before beginning to connect the loads, check that the nominal power of the EPS indicated on the rating plate technical data is more than or the same as the total sum of the load powers. The choice of the type and section of the connecting cables depending on their design current and installation must be done as indicated in the current standards.

#### **INDICATION**

Chapter 10 shows the instructions for sizing the output cables.

Provide a separate switchgear for the load. It is advisable to use switches or automatic breakers in line with IEC standards to protect the lines that originate from the switchgear.

Indicate the values reported below on the system switchgear by means of stickers or similar:

- maximum nominal power of the total load;
- maximum nominal power of the load at the load outlets;
- if a common switchgear is used (mains and EPS power outlets), make sure that there is an indication of the relative power source on every power outlet ("Mains" or "EPS").

## 4. Installation

The default configuration is SINGLE-PHASE INPUT and SINGLE-PHASE OUTPUT for Trimod MCS 3-5-7 and THREE PHASE INPUT and THREE PHASE 120° OUTPUT for Trimod MCS 10-15-20-30-40-60-80.

If this type of distribution is used, the connection jumpers are correctly sized and positioned. For different configurations, it is necessary to consult paragraph 4.3 that includes the connection diagrams and chapter 5.

The connection must be made according to the passages indicated below:

- Before beginning to connect the output, check that the EPS is off and that the output terminals are not live.
- Connect the output line earth cable to the appropriate terminal, or secure it to the base of the equipment (in case of Trimod MCS 80).
- Connect the line output neutral cable to the Nout output terminal.
- Connect cables L1, L2 and L3 of the output line to the L1out, L2out and L3out output terminals, being careful to observe the phase sequence (L1, L2, L3).

### 4.3 Wiring diagrams

The electric configuration is completed both on the control panel and the distribution terminal box. For the explanation of the meaning of the A.R.B.C terminal see paragraph 4.3.9.



#### WARNING

Always check that the screws of the connection jumpers are tight. If the factory configuration is changed, make sure to configure the new mode of operation using the control panel as indicated in chapter 5.

#### 4.3.1 Factory configuration Trimod MCS 3-5-7: SINGLE PHASE input - SINGLE PHASE output

The EPS default configuration is set in the factory according to the following diagrams depending on the model.

It is however recommended that a check is made of the correct configuration of the connection jumper.

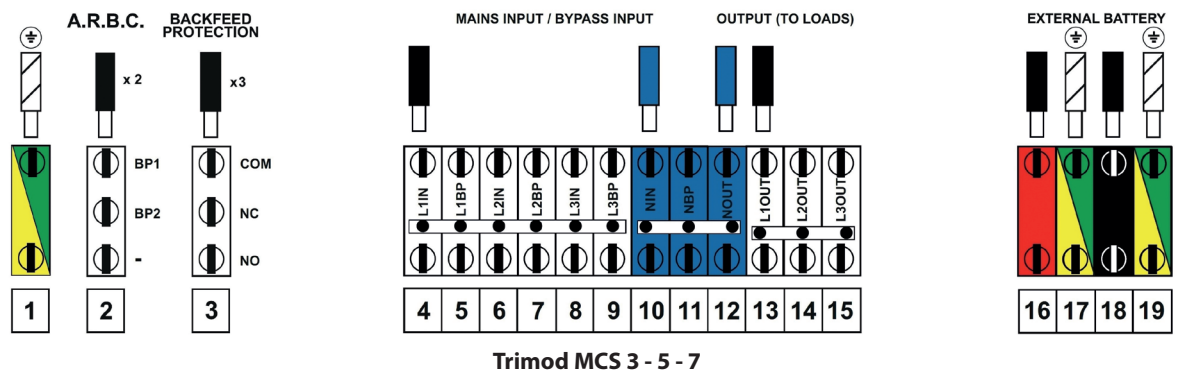

**4.3.2 Factory configuration Trimod MCS 10-15-20-30-40-60-80: THREE PHASE input – THREE PHASE output with common bypass input line**

The EPS default configuration is set in the factory according to the following diagrams depending on the model. To use this configuration, no further action is necessary; it is however recommended that a check is made of the correct configuration of the connection jumper.

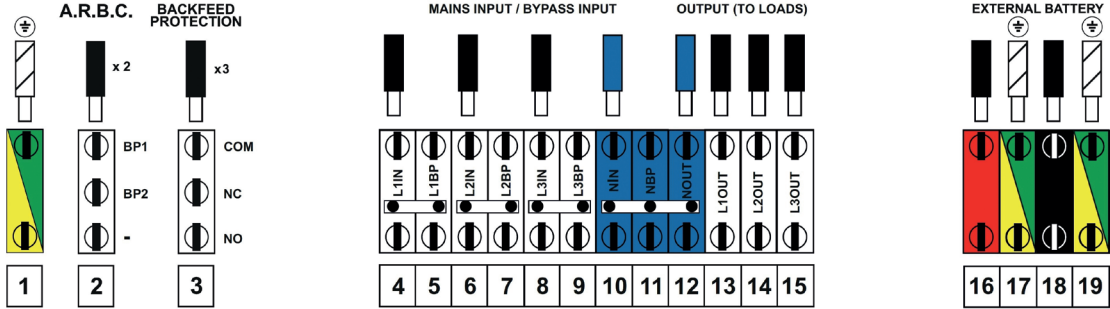

Trimod MCS 10 - 15 - 20

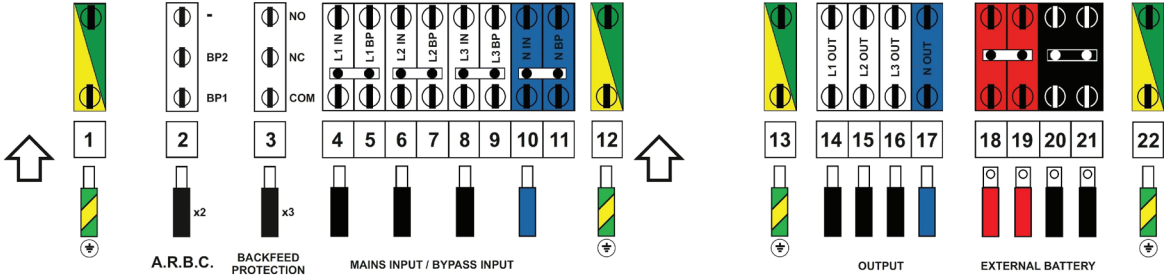

Trimod MCS 30

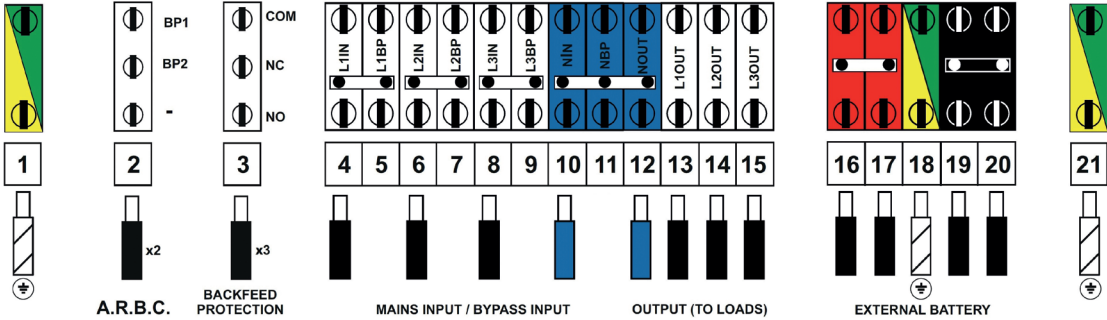

Trimod MCS 40 – 60

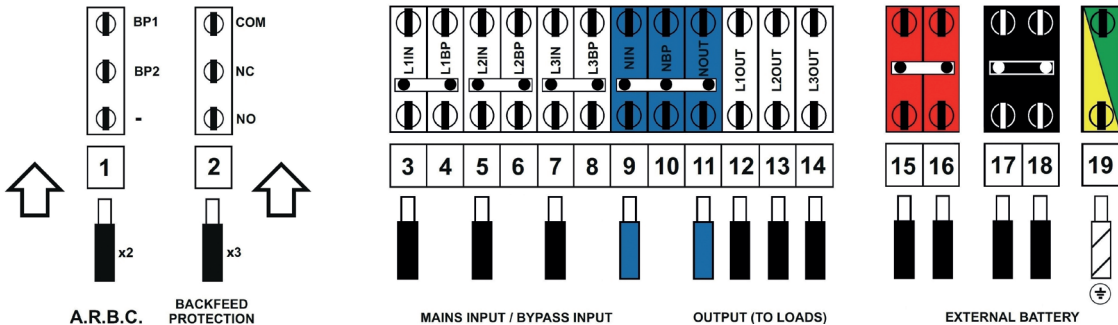

Trimod MCS 80

## 4. Installation

### 4.3.3 THREE PHASE input - THREE PHASE output connection with separate bypass input line

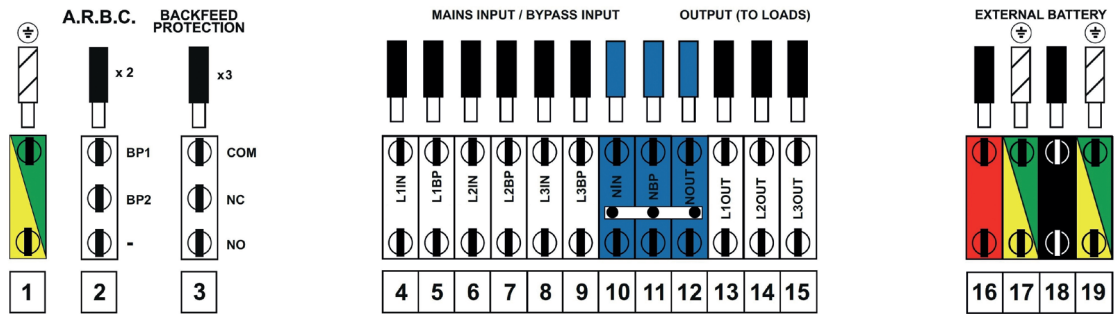

Trimod MCS 10 - 15 - 20

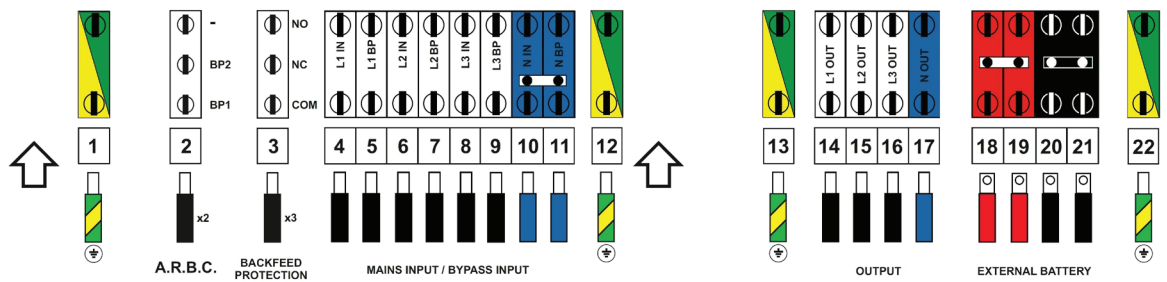

Trimod MCS 30

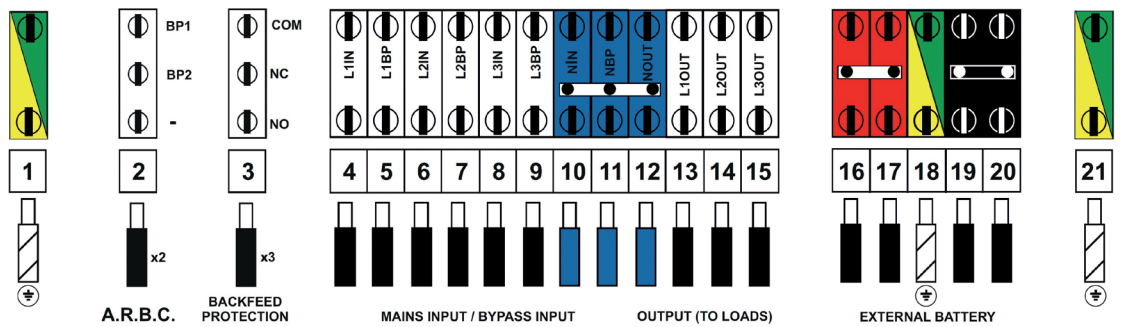

Trimod MCS 40 - 60

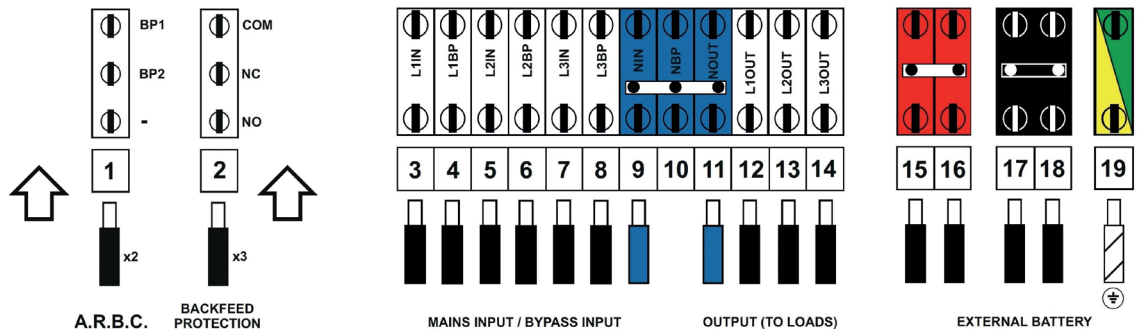

Trimod MCS 80

**4.3.4 THREE PHASE input – SINGLE PHASE output connection**

This connection is available only for Trimod MCS 10, 15, 20 and 30. In addition to the wiring shown in the following images, it is necessary to configure the functioning mode as illustrated in chapter 5.

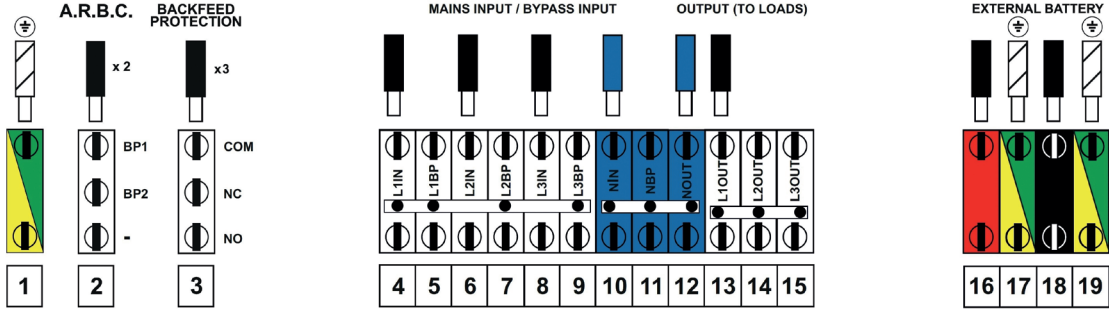

**Trimod MCS 10 - 15 - 20  
with common bypass input line**

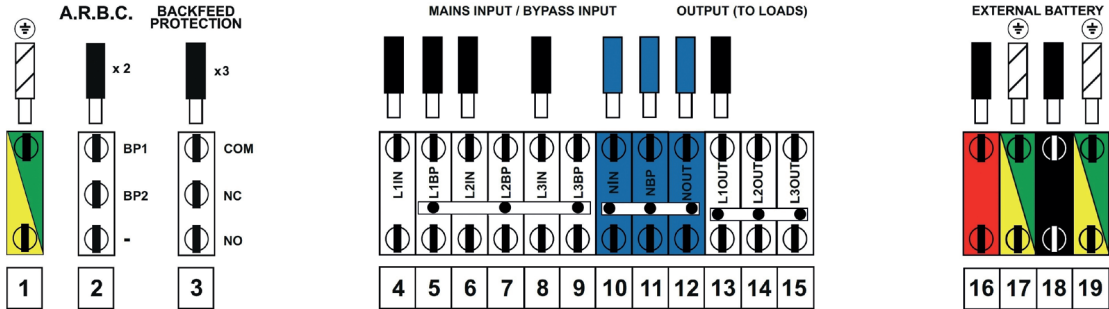

**Trimod MCS 10 - 15 - 20  
with separate bypass input line**

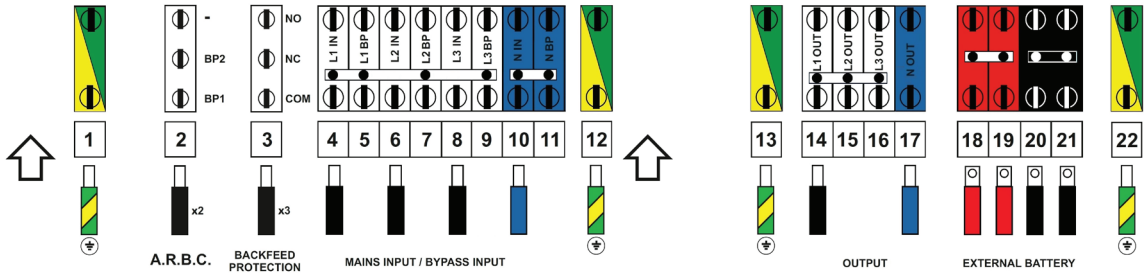

**Trimod MCS 30  
with common bypass input line**

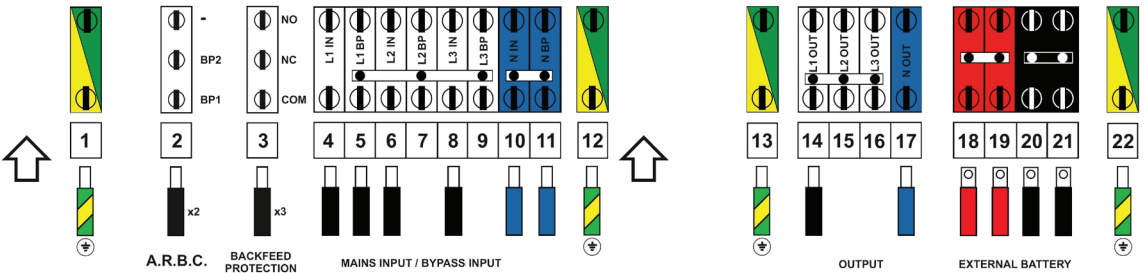

**Trimod MCS 30  
with separate bypass input line**

## 4. Installation

### CAUTION

For the configuration with single phase output, it is necessary to insert in all the back panel boards a special connector provided in the accessory kit.

The back panel boards are located in the equipment behind the power modules. In the Trimod MCS 10, 15 and 20 models there is just one back panel board. In the Trimod MCS 30 model there are two back panel boards.

The connector must be inserted in the position indicated by EC 15 serigraphed onto the board as shown in the following figure:

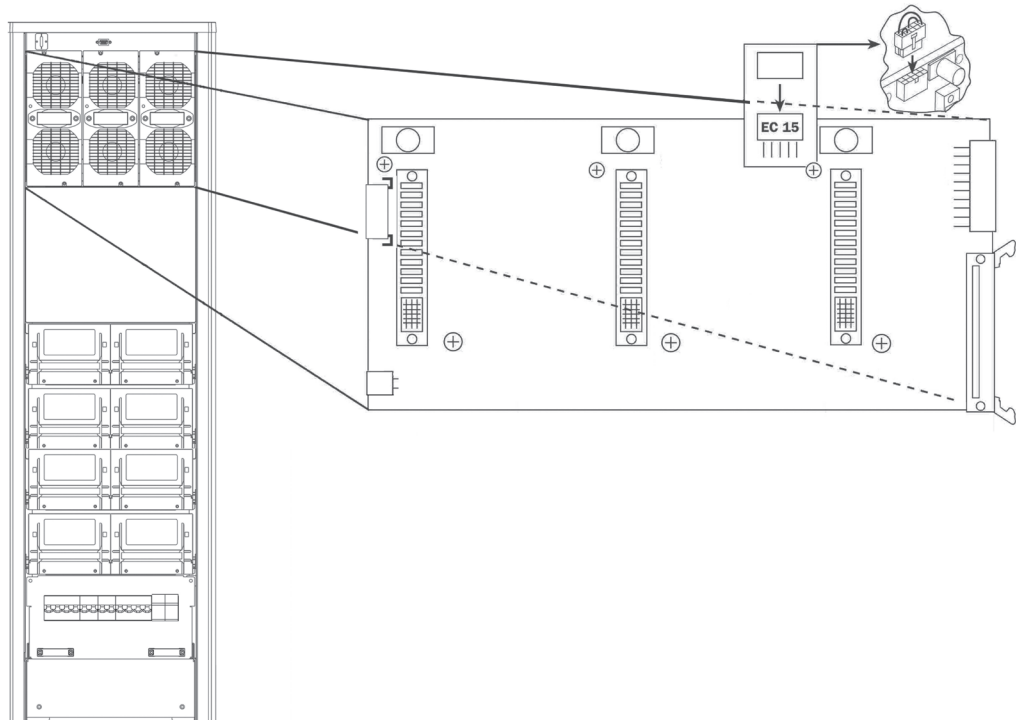

### 4.3.5 SINGLE PHASE input - SINGLE PHASE output connection

This connection is available only for Trimod MCS 10, 15, 20 and 30.

In addition to the wiring shown in the following images, it is necessary to configure the functioning mode as indicated in chapter 5.

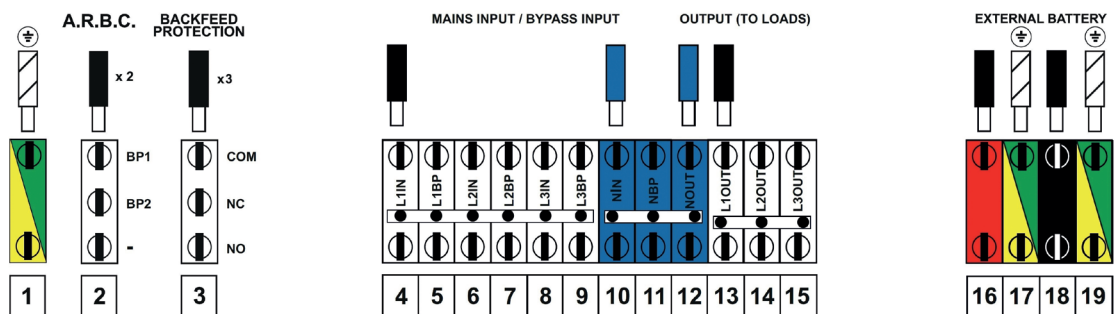

Trimod MCS 10 - 15 - 20  
with common bypass input line



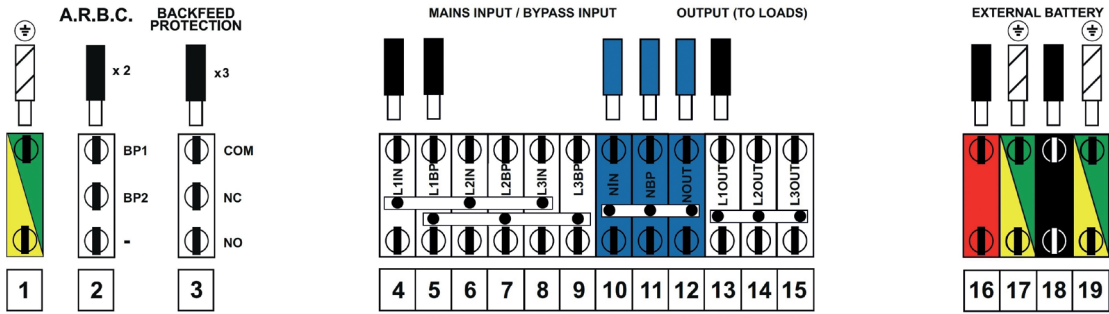

**Trimod MCS 10 - 15 - 20  
with separate bypass input line**

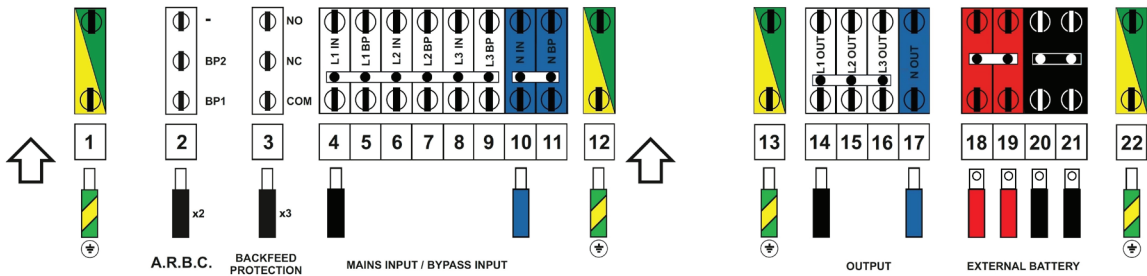

**Trimod MCS 30  
with common bypass input line**

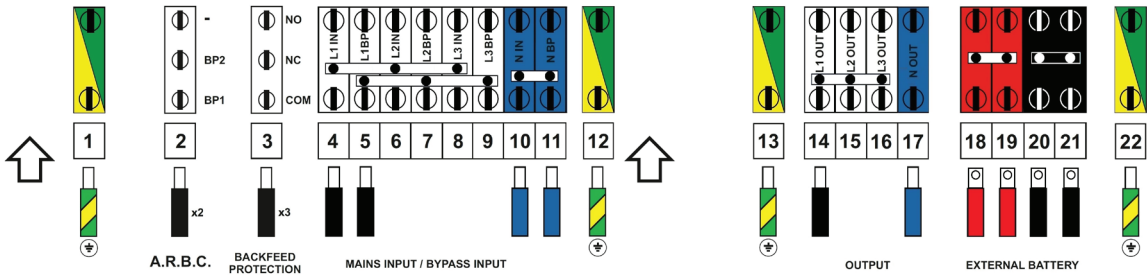

**Trimod MCS 30  
with separate bypass input line**

## 4. Installation

### CAUTION

For the configuration with single phase output, it is necessary to insert in all the back panel boards a special connector provided in the accessory kit.

The back panel boards are located in the equipment behind the power modules. In the Trimod MCS 10, 15 and 20 models there is just one back panel board. In the Trimod MCS 30 model there are two back panel boards.

The connector must be inserted in the position indicated by EC 15 serigraphed onto the board as shown in the following figure:

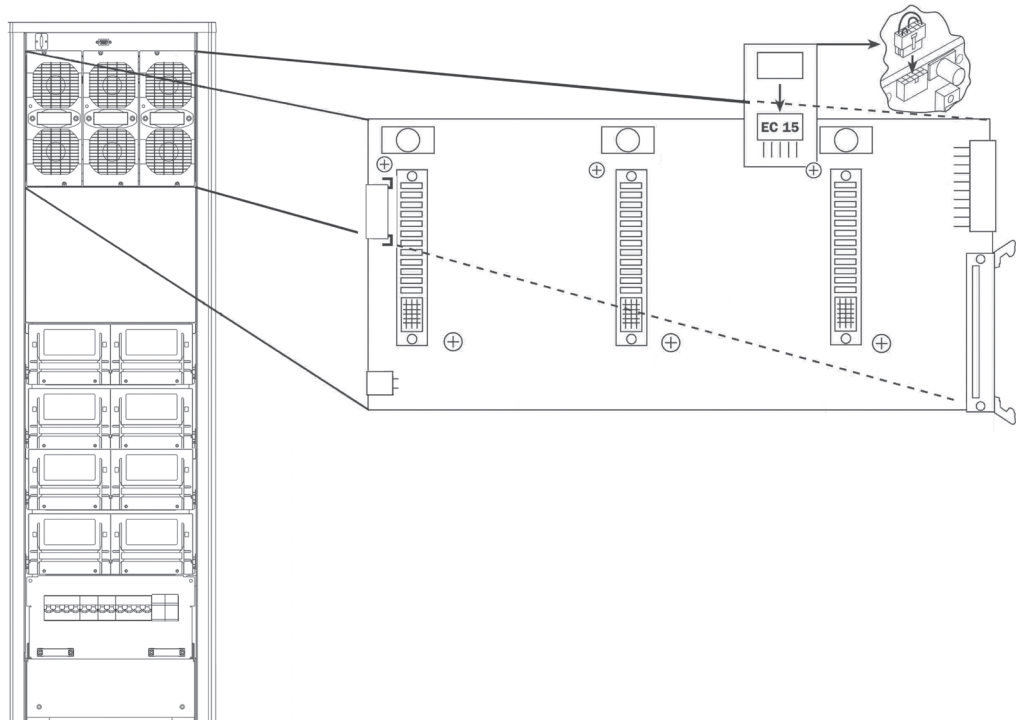

### 4.3.6 SINGLE PHASE input - THREE PHASE 120° output connection

This connection is available only for Trimod MCS 10, 15, 20 and 30.

In addition to the wiring shown in the following images, it is necessary to configure the functioning mode as indicated in chapter 5.

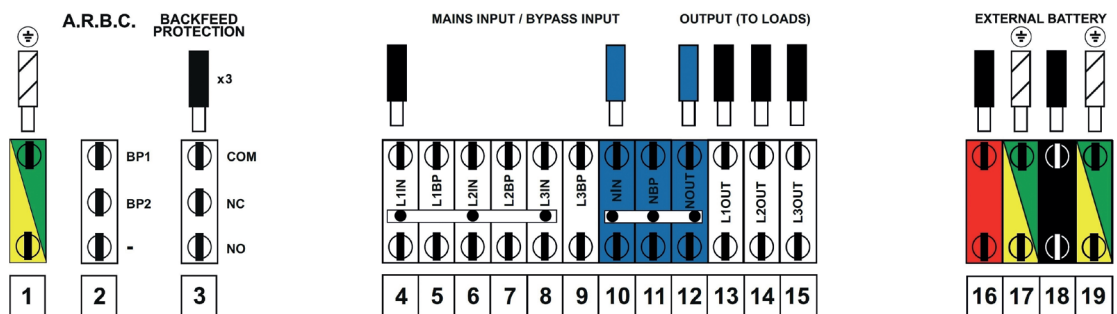

**Trimod MCS 10 - 15 - 20  
(disabled bypass input line)**



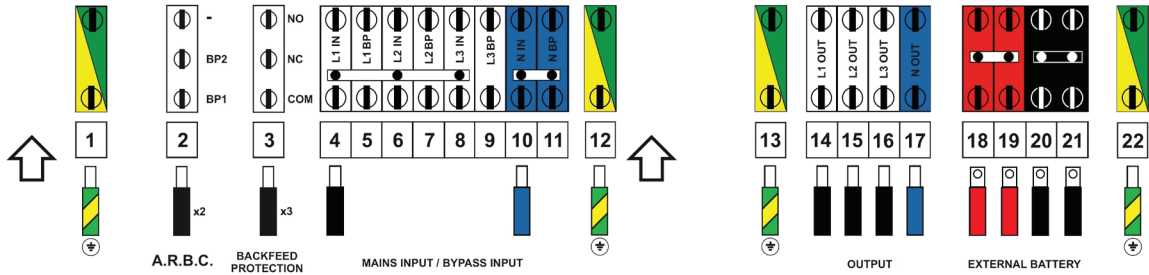

**Trimod MCS 30**  
(disabled bypass input line)

**CAUTION**

The bypass function is not available for the configuration with single phase input and three phase 120° output. The manual maintenance bypass switch S1 and bypass input line switch S5 must NEVER be activated. For greater safety, it is possible to completely eliminate the manual maintenance bypass by cutting the brown, black and grey cables that connect the relative S1 switch to the output S2 switch and being careful to isolate the wires adequately.

**4.3.7 SINGLE PHASE input - THREE INDEPENDENT PHASE output connection**

This connection is available only for Trimod MCS 10, 15, 20 and 30. In addition to the wiring shown in the following images, it is necessary to configure the functioning mode as indicated in chapter 5.

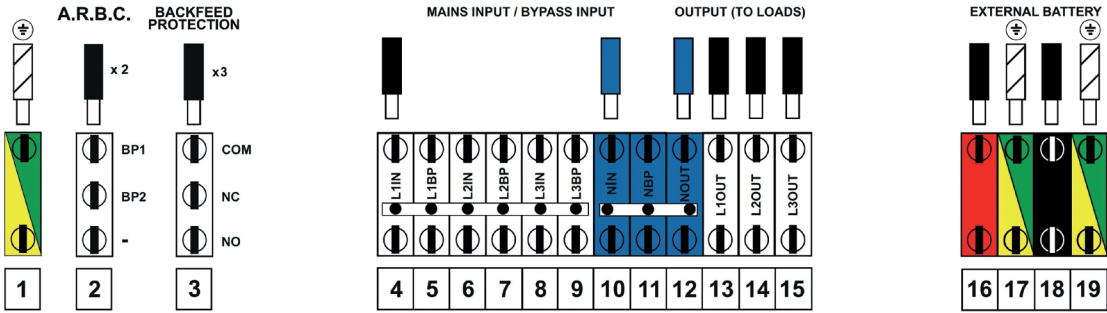

**Trimod MCS 10 - 15 - 20**  
with common bypass input line

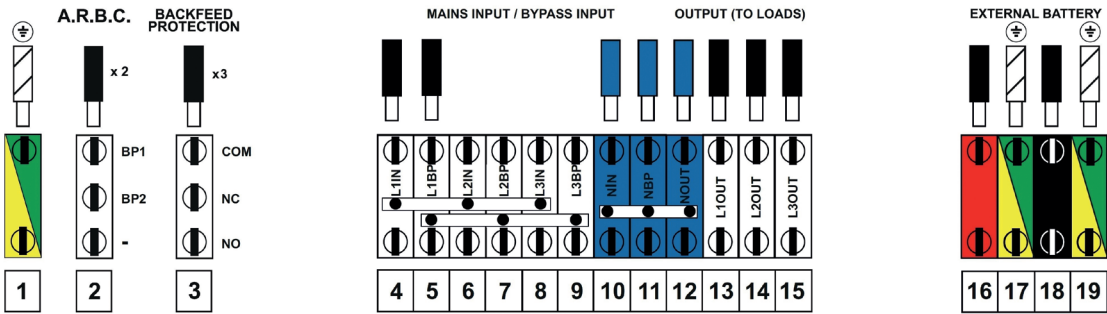

**Trimod MCS 10 - 15 - 20**  
with separate bypass input line

## 4. Installation

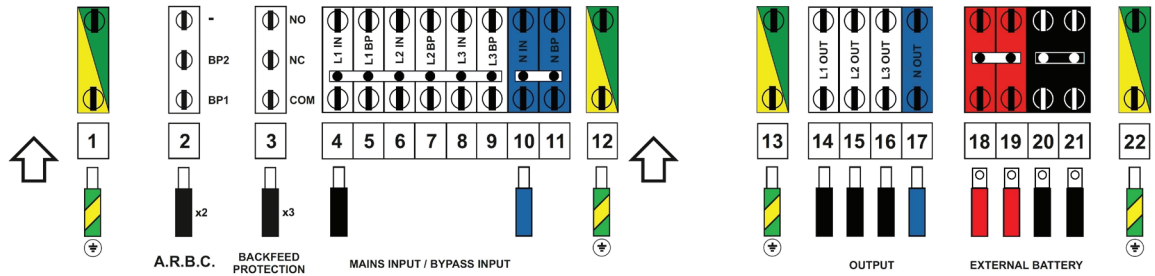

**Trimod MCS 30  
with common bypass input line**

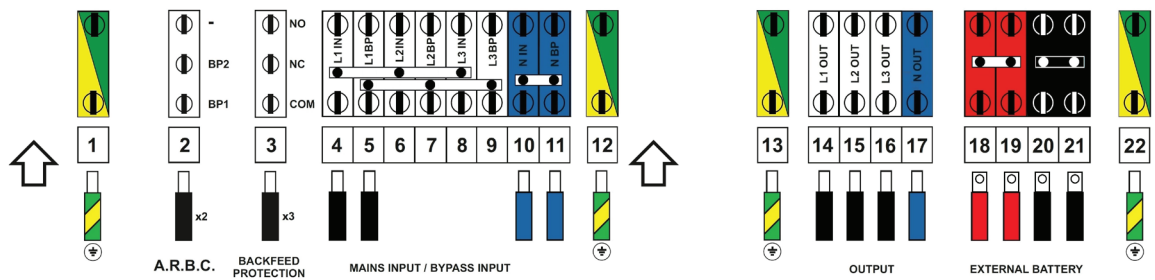

**Trimod MCS 30  
with separate bypass input line**

### 4.3.8 Installation of the connection jumpers

1. Take one of the connection jumpers out of the accessory envelope and cut it so as to make it the requisite length. Check that after the cut there are no burrs that could cause contact with adjacent jumpers.

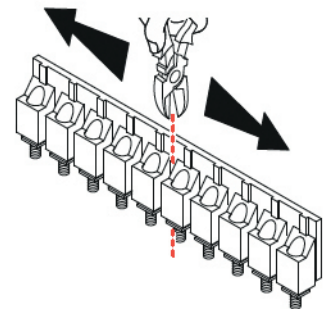

2. Eliminate the vertical connections that are not represented in the connection diagrams.

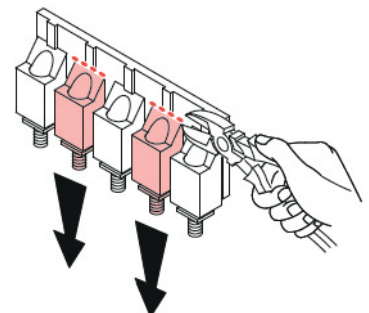

3. Insert the jumper into the terminal strip as shown in the connection diagrams.

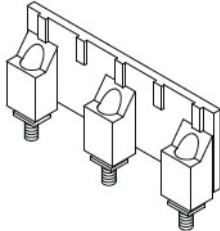

4. Carefully tighten all the screws to the terminal strip.

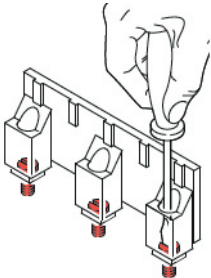

5. Tighten up the terminals.

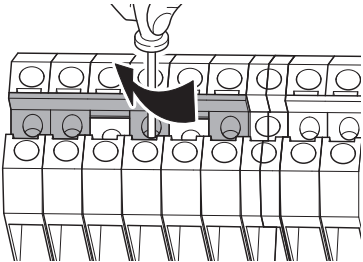

6. Use the screwdriver to extract the yellow plastic part.

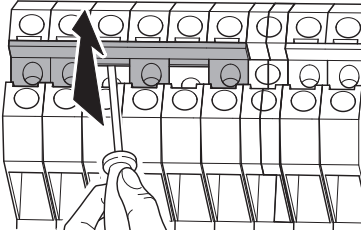

7. Check that the screw head abuts properly on the terminals.

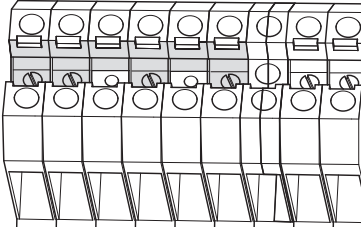

8. Reinsert the yellow plastic part.

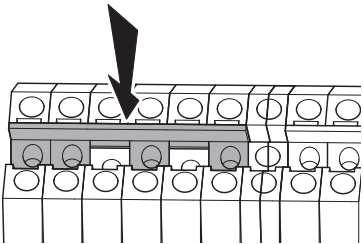

### 4.3.9 ARBC (Auxiliary Remote Bypass Contact)

Trimod MCS makes it possible to enable EPS forced bypass functioning without any operation from the control panel but simply through a normally open external contact.

The external bypass contact terminal is found on the terminal strip and is marked by the wording "A.R.B.C."

For the correct connection of the external contact, the following requirements must be adhered to:

- use a double-insulation cable of up to 10 meters in length;
- make sure that the switch used is galvanically isolated.

The electric characteristics of the auxiliary remote bypass contact are the following:

- voltage with open contacts: less than 100 V
- current with closed contacts: less than 100 mA

The figure below shows how the external bypass contact must be connected:

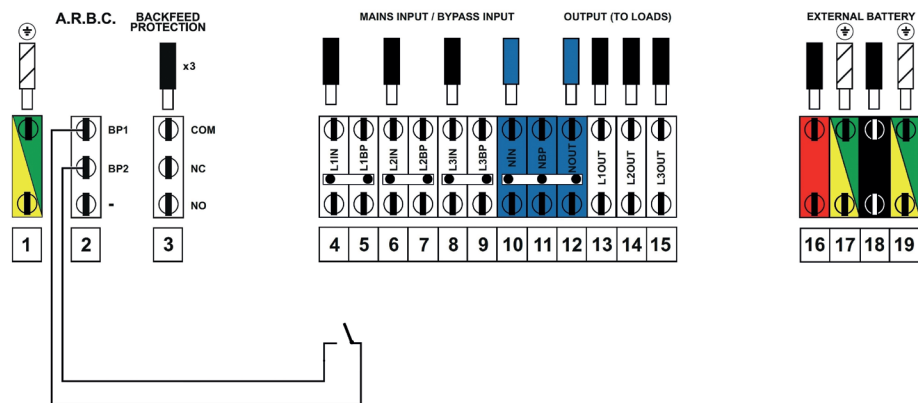

#### CAUTION

After the forced bypass enable contact is closed, mains input is powered. When this contact is opened, the output is no longer powered.

#### INDICATION

It is not possible to use the auxiliary contact if the EPS is configured as a single phase input-three phase 120° output.

### 4.4 Insertion of power modules and battery drawers

Once all the electrical connections have been made, close the distribution drawer for the Trimod MCS 3, 5, 7, 10, 15, 20 models or screw up the lower panels for the Trimod MCS 30, 40, 60 and 80.

It is then possible to move onto the insertion of the power modules and battery drawers into the EPS (depending on the model) and in the external modular battery units (if there are any).



#### WARNING

The Trimod MCS EPS have electrical distribution sized for the nominal power of the equipment and must be used exclusively with the power modules provided as shown in the "Mechanical characteristics" table in chapter 9 of this manual. Do not use power modules that differ from those indicated and do not exchange the modules with each other and/or replace them to vary the power of the EPS.

The model, the nominal power and the type of power module to be installed in the Trimod MCS EPS are indicated in the manuals and on the rating plate inside the door of the EPS.

The type and the nominal power of the power module are indicated on a rating plate at the back of the module.

Insert the power modules one at a time checking that they abut. Fix them to the frame with the two screws provided with each module. Use SHC M4x20 screws (hex socket head). The two fixing screws also act as the module's earth connection and must both be fixed for safety purposes.

If one or more power modules are not installed, the free slots must be protected by using the plastic cover of the kit 3 108 66 in each of them. The cover must be fixed with two TCEI M4x20 screws.

## 5. Configuration and Starting-up



### DANGER

All the configurations and start-up operations must be done only by a SKILLED TECHNICIAN (paragraph 2.2.1)

### 5.1 Introduction

This chapter contains all the information necessary for a correct configuration of the Trimod MCS EPS and for its subsequent startup.

The factory configuration provides SINGLE-PHASE INPUT and SINGLE-PHASE OUTPUT for Trimod MCS 3-5-7 and THREE PHASE INPUT and THREE PHASE 120° OUTPUT for other models.

### 5.2 Input configuration

Trimod MCS automatically recognises the input voltage, frequency and number of phases if the electrical connection on the terminal strip is modified.



### CAUTION

Make sure the neutral cable is always connected.

### 5.3 Output configuration

Trimod MCS does not automatically recognise the electrical configuration on the output terminal strip. For this reason it is ALWAYS necessary to select the type of output voltage from the control panel according to the applied load.

The default configuration for the Trimod MCS 3-5-7 EPS is single-phase; for the other models is three phase 120°, 400Vac. The equipment can also be configured to obtain a unique single phase output 230 Vac in the Trimod MCS 10,20 and 30 models.

If the EPS is configured with three phase output, it is possible to select the management of the three phase as follows :

- THREE PHASES 120°: this is the default setup and is usually used if three phase loads are applied on the output (e.g. three phase electrical motors) or if there are both three phase and single phase loads. The EPS manages the three output phases protecting the three phase load. For example, if an excessive load is applied to one of the three output lines, the automatic bypass switches all three lines on output.
- THREE SINGLE PHASE OUTPUTS: this setup is necessary if three single phase lines have been created with the common neutral on the output. The EPS manages the three outputs completely independently of each other. For example, if an excessive load is applied to one of the three output lines, the bypass only cuts in on the overloaded line, while the power supply continues to be guaranteed on the other two by the equipment. If the input is single phase, the three lines are not in phase but rather with a phase shift of 120° and therefore cannot be connected in parallel. If the input is three phase, the outputs are in phase and the possibility of using the bypass is guaranteed.

For the correct selection of the output configuration, follow the instructions given in section 5.5.

### 5.4 Pre-start-up checks

Before powering the equipment, carry out the following checks:

1. Check that the mains input switch S3 of the EPS is open (OFF position).
2. Check that the bypass input switch S5 of the EPS is open (OFF position).
3. Check that the battery fuse breakers of the EPS FB+ and FB- (if the model includes them) and those inside the Trimod MCS BATTERY (if present) are open (OFF position).
4. Check that the maintenance bypass switch S1 and the output switch S2 of the EPS are open (OFF position)
5. Check that the wiring on input and output has been done and that all the connections have been tightened up properly.
6. Check the correct phase sequence of the mains input and bypass line (if separate).
7. Check that the parameters (voltage and frequency) of the input line are compatible with those shown on the rating plate.
8. Check that all the power modules are inserted properly and that the fixing screws of the power modules are present and screwed up to abut the relative slots (use SHC M4x20 screws with hex socket head).
9. Check that all the battery drawers, if present, are inserted properly and that all the fixing screws are present and screwed up to abut the relative slots (use SHC M4x20 screws with hex socket head).

## 5. Configuration and Starting-up

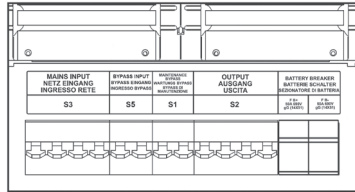

Trimod MCS 3-5-10

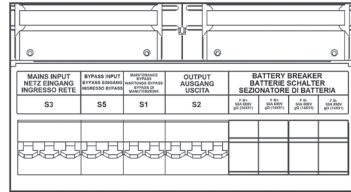

Trimod MCS 7-15-20

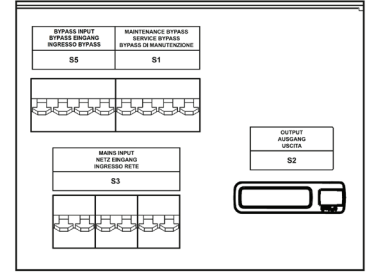

Trimod MCS 30

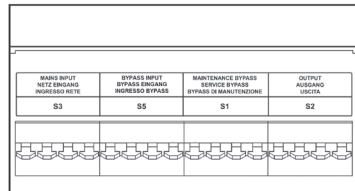

Trimod MCS 40-60

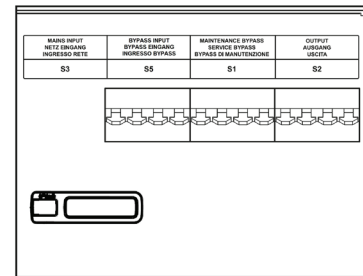

Trimod MCS 80

### 5.5 Start-up procedure

1. Insert the battery fuses into the appropriate fuse breakers of the Trimod MCS, if the model includes them and inside the external Trimod MCS BATTERY (if present).
2. Close the battery fuse breakers of the EPS and Trimod MCS BATTERY FB+ and FB- (if present).



#### CAUTION

Before turning on the EPS it is necessary to select the correct output configuration (Single phase/ Three Phases 120° / Three independent phases). In order to do so, the rest of the procedure must be applied.

3. With the EPS off, press the ENTER key on the control panel and keep it held down until the text "Language" appears. Using the ARROW UP and ARROW DOWN keys, select the language you require and confirm your choice with ENTER key.
4. Then press the ESC key to leave the Language page. The text "Service Mode" appears on the display.

For further information about the function Service Mode and how the control panel works, consult the user manual.



#### CAUTION

Trimod MCS is able to recognise the presence of non aligned firmware among the power modules and therefore prevent the start-up.

In Service Mode the status indicator flashes orange rapidly and the texts "Service Mode" and "PM FW not updated!" Follow the path **Power Modules** → **PM SW update** to update the power module firmware. It is possible to choose **Update all PM** to check and if necessary update all the power modules, while with the option **Single PM SW update** you can select the specific power module to update.

5. Press the ENTER key to enter the menu. Using the ARROW UP and ARROW DOWN keys, it is possible to move the selection on the display; the ENTER key is used to confirm the choice and the ESC key is used to cancel the choice.

Follow the path **UPS Setup** → **Output** → **Inverter**

Select "Three Phases 120°" / "Three Phases indep." / "Single Phase" in accordance with the type of load and distribution downstream of the EPS.

**CAUTION**

**The inverter output configuration must correspond with the configuration set on the output terminal strip during the installation.**

Wrong connections or incorrect output configurations may cause injury and/or damage.

6. Follow the path **UPS Setup → Output → Voltage and UPS Setup → Output → Frequency** to check that the voltage and the frequency of the set outputs are the ones required.
7. Follow the path **UPS Setup → Options → Output options** to select whether the output is enabled or disabled in normal mode. The default value set is "ENABLED".
8. Follow the path **UPS Setup → Batteries → Total KB** to select the correct number of KB (Battery Kits) installed.

**INDICATION**

1 KB (Battery Kit) represents a string of 20 batteries in series.

In case of models with internal battery drawers and for external modular battery units, 1 KB comprises 4 battery drawers.

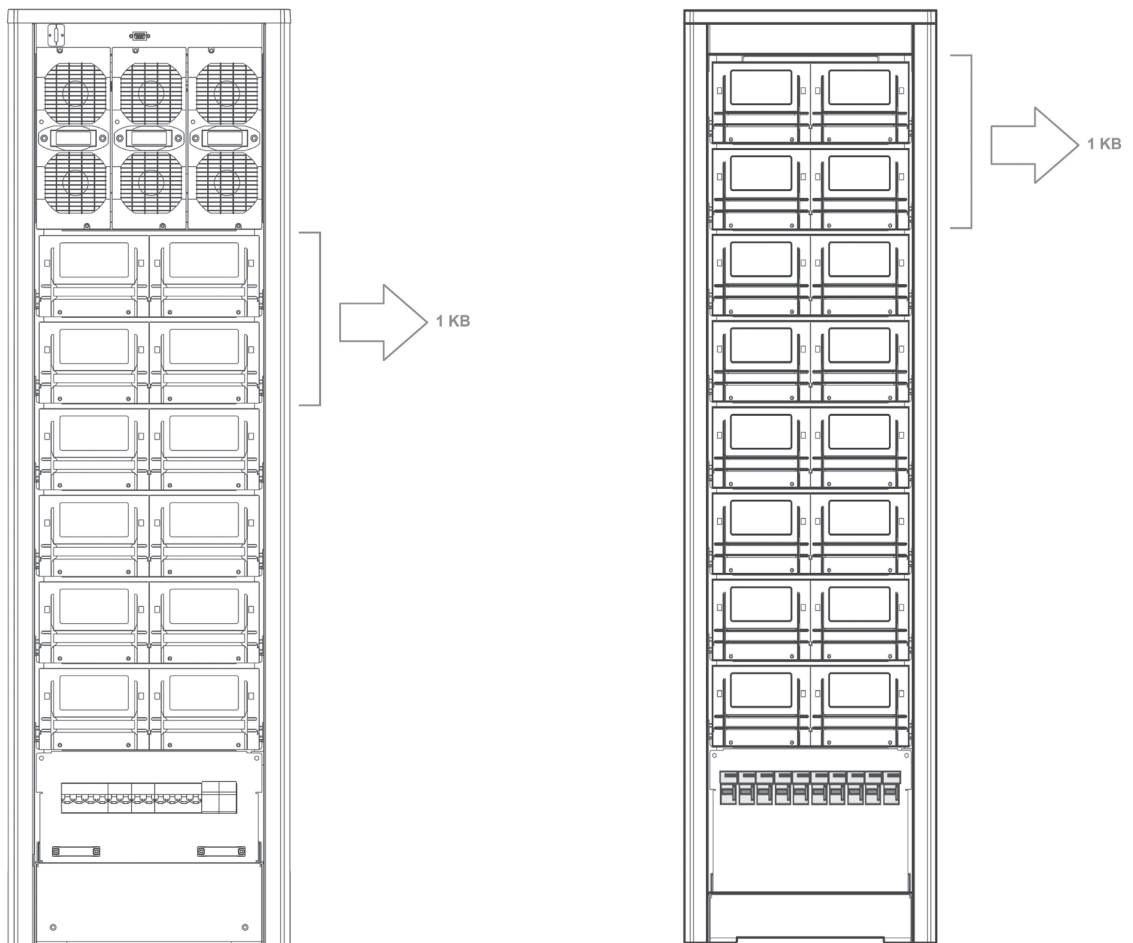

It is necessary to install 1 KB every 10 kVA of nominal EPS power in case of modular cabinets with battery drawers. For example, for the Trimod MCS 40 it is necessary to have at least one external modular battery cabinet with 4 KB (16 battery drawers).

In case of non-modular 94Ah external battery cabinets, each unit represents 1 KB and 1 KB is sufficient for all the Trimod MCS models.

9. Follow the path **UPS Setup → Batteries → Capacity** to select the correct value of the capacity in Ah of the individual KB.

**INDICATION**

The EPS calculates the total battery capacity as produced by the total KB \* Capacity.

10. Leave the Service Mode pressing the ON/OFF key.

11. Provide the power supply to the equipment and close the S3 mains input switch and S5 bypass input switch (ON position) of the EPS.

**INDICATION**

If the "Standby Charge" is enabled, when the EPS is powered a battery charge cycle is started automatically. Press the ESC key to interrupt the standby charge and proceed with the power up of the Trimod MCS as described below.

12. Press the ON/OFF key to turn on the EPS. When the display shows the text "<ENTER> to confirm UPS turn ON", press the ENTER key.



**CAUTION**

If the firmware of the power modules is out of alignment, the status indicator flashes red rapidly and the display shows the text "Invalid PM SW Versions: ⬅ to execute update".

Press the ENTER key to update the modules and complete the start up phase. Press the ESC key to interrupt the update and start-up procedures.

If no operation is carried out within 30 seconds, the EPS turns off.

13. Wait for the backlit status indicator on the control panel to show a steady green light.

14. Check that the output voltage and frequency values set correspond with the requirements of the applied load. If this is not the case, insert the values necessary (see the user manual).

15. Close the S2 output disconnect switch (position ON) of the EPS. The load is not powered. When there is a power cut, the load is powered by the EPS.

16. Close the EPS door and remove the key.

**INDICATION**

If during the installation phase it is necessary to check the proper functioning of the EPS in battery mode, remove the mains by means of the breaker placed upstream of the EPS.



**CAUTION**

Do not remove the power modules during the functioning of the EPS without first having activate the proper replacement procedure (described in paragraph 7.4). The removal of one or more power modules without the proper use of the procedure could damage the equipment.

**INDICATION**

The keys for opening the EPS door must not be left at the operator's disposal.

**INDICATION**

The installation and maintenance manual must not be left at the disposal of the operator.



## 6. Maintenance



### DANGER

**ORDINARY MAINTENANCE operations may be done only by SKILLED TECHNICIANS (paragraph 2.2.1). EXTRAORDINARY MAINTENANCE operations may be done only by the LEGRAND TECHNICAL SUPPORT SERVICE.**

### 6.1 Introduction

This chapter contains all the information necessary to a skilled technician for a correct maintenance of the Trimod MCS EPS.



### DANGER

The operator is not authorised to perform the operations contained in this chapter. LEGRAND declines all liability for any injury or damage caused by activities carried out differently from the instructions in this manual or by a skilled technician who does not observe the requirements laid down in the installation and maintenance manual.

### 6.2 Preventive maintenance

The EPS does not contain parts for preventative maintenance by the operator.

The operator must regularly perform:

- a general external cleaning;
- a check to verify the absence of alarms on the display;
- a check to verify the correct functioning of the fans on each power module.

During a preventive maintenance inspection the skilled technician must carry out the following checks:

- no alarm presence;
- list of the memorised events;
- correct function of the static and maintenance bypass;
- integrity of the electrical installation;
- flow of cold air;
- battery status;
- characteristics of the applied load;
- conditions of the installation location.

After the first year of EPS life, check the batteries every six months through the "battery calibration" function to guarantee the optimal operation and continuous protection of the connected load. With this function, the EPS detects the discharge curve of the batteries.

To activate the function, enter the main menu and follow the path **Tools → Batteries → Batt. Calibration**. Press the ENTER key to confirm the choice.

Contact the LEGRAND Technical Support Service in case of problems.

### 6.3 Periodical checks

The correct functioning of the EPS must be guaranteed by periodical maintenance inspections. These are essential to safeguard its reliability.



### WARNING

The periodical checks involve operations inside the EPS in presence of dangerous voltages. Only maintenance personnel trained by LEGRAND are authorized to work.

## 6. Maintenance

### 6.4 Ordinary maintenance

#### 6.4.1 Maintenance procedure with EPS off

This mode is necessary to perform maintenance or replace parts such as power modules, command boards, backplanes, update the EPS firmware, etc.

1. Keep the ON/OFF key pressed for at least two seconds.
2. When the display shows the text "Turn off the UPS?", press the ENTER key.
3. Wait for the shutdown operations to complete.
4. Open the (S2) output disconnecter by bringing it to the OFF position.
5. Open the (S3) mains disconnecter and (S5) bypass input disconnecter by bringing them to the OFF position.
6. Open the battery fuse breakers of the EPS and Trimod MCS BATTERY (if present).
7. Press the ON/OFF key to discharge any internal capacity.
8. Open the circuit breaker upstream of the EPS which supplies power from the mains. If these operations are performed correctly, there will be no voltage to the equipment. It is now possible to proceed with the maintenance operations.

#### WARNING

Inside the upper part of the EPS where the command boards and the contact interface card are located there could be dangerous voltage due to the connection of the external backfeed control line. Be careful of connector EC9 of the relay interface card to which the backfeed line is connected.

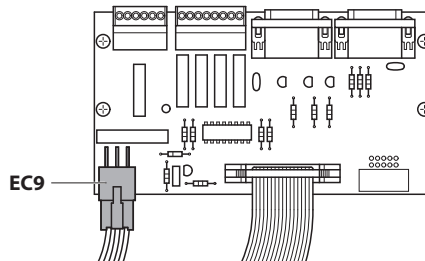

**Note:** by protecting external backfeed protection as indicated in the diagrams in paragraph 4.2.6, it is possible to disconnect the line from the outside and secure it.

#### 6.4.2 Maintenance procedure for the EPS in maintenance bypass mode

This mode is necessary to perform maintenance or replace parts such as power modules, command boards, backplanes, update the EPS firmware, etc.

#### CAUTION

During forced and maintenance bypass operations, the load is supplied by the bypass input line and is not protected by the EPS

#### CAUTION

The power modules must not be replaced without adhering scrupulously to the instructions below.

#### Accessing the manual maintenance bypass mode

1. Open the Trimod MCS door.
2. Enable the EPS in forced bypass mode. Enter the main menu and follow the path **UPS Setup → Bypass → Forced Mode**. Set the value of the parameter to "Enable" with the ARROW UP/DOWN keys. Press the ENTER key to confirm.  
In this condition the power modules are excluded and the load is powered directly from the mains. The display shows the text "Forced on Bypass". When the equipment is in forced bypass mode, the status indicator flashes quickly. The LEDs on the power modules flash quickly as well.
3. Close the maintenance manual bypass disconnecter (S1) by bringing it to the ON position. The load is powered directly from the mains. The display shows the text "Maintenance Bypass".
4. Open the (S2) output disconnecter by bringing it to the OFF position.

5. Shutdown the EPS by holding the ON/OFF key down for a few seconds. When the display shows the text "Turn off the UPS?", press the ENTER key.
6. Open the (S3) mains input disconnecter and (S5) bypass input disconnecter by bringing them to the OFF position.
7. Open the battery fuse breakers of the EPS and all the Trimod MCS BATTERY (if present).
8. Press the ON/OFF key to discharge any internal capacity. It is now possible to proceed with the maintenance operations.

**WARNING**

In the case of models with internal batteries, some parts remain with dangerous voltage even after all the battery fuse breakers are opened. Remove at least one battery drawer for every shelf present in order to interrupt the battery string set.

**WARNING**

Inside the upper part of the EPS where the command boards and the contact interface card are located there could be dangerous voltage due to the connection of the external backfeed control line. Be careful of connector EC9 of the relay interface card to which the backfeed line is connected.

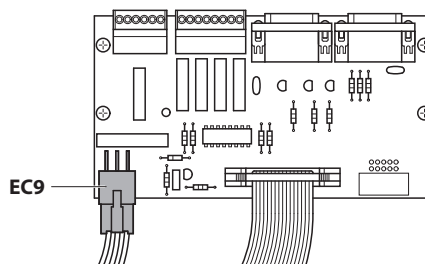

**Note:** by protecting external backfeed protection as indicated in the diagrams in paragraph 4.2.6, it is possible to disconnect the line from the outside and secure it.

### Power module replacement or inclusion of new modules

1. Check that the procedure for placing in maintenance bypass mode described above has been applied.
2. Extract the power module after undoing the two fixing screws.

**CAUTION**

On the cover of the power module there are two holes from which it is possible to see two LEDs that signal the presence of dangerous voltage on the rear connection. Before performing any operation on the power module, make sure that these LEDs are off. If they are on, wait for them to turn off.

3. Check that the two LEDs visible through the two holes in the side cover of the new power module are off. If they are on, wait for them to turn off.
4. Insert the new power module in the same slot where the previous one was located.
5. Fix the new power module to the frame with the two screws provided along with the power module, making sure they abut. Use SHC M4x20 screws (hex socket head). The two fixing screws allow the module's earthing and must both be fixed for safety purposes.

The procedure described does not need further manual settings from the control panel. The EPS automatically recognises the new power module and it is configured automatically.

### INDICATION

The procedure to add power modules is similar to the previous one. At point 2 remove the plastic covers of kit 3 108 66 which protect the empty slots where new power modules are to be added.

### Exit from maintenance manual bypass

To transfer the EPS from the maintenance bypass mode to the normal mode, do the following:

1. Check that the output disconnecter (S2) is open (OFF position).
2. Close all the battery fuse breakers of the EPS and all the Trimod MCS BATTERY (if present).
3. Close the mains input disconnecter (S3) and bypass input disconnecter (S5) by bringing them to the ON position.

## 6. Maintenance

4. Press the ON/OFF key to turn on the EPS. When the display shows the text "<ENTER> to confirm UPS turn ON", press the ENTER key.



### CAUTION

Trimod MCS is able to recognise the presence of non aligned firmware among the power modules and therefore prevent the start-up.

If the firmware of the power modules is out of alignment, the status indicator flashes red rapidly and the display shows the text "Invalid PM SW Versions: ← to execute update".

Press the ENTER key to update the power modules and complete the start up phase of the EPS. Press the ESC key to interrupt the update and start-up procedures.

If no operation is carried out within 30 seconds, the EPS turns off.

5. Wait for the power-on procedure to be completed. The main screen is shown on the display. In this condition the load is supplied directly by the bypass line. The display shows the text "Manual Bypass" and "Forced on Bypass". The backlit status indicator becomes orange.
6. Open the output disconnecter (S2) by bringing it to the ON position.
7. Open the maintenance manual bypass disconnecter (S1) by bringing it to the OFF position.
8. Enable the EPS in normal mode. Enter the main menu and follow the path **UPS Setup → Bypass → Forced Mode**. Set the value of the parameter to "Disabled" with the ARROW UP/DOWN keys. Press the ENTER key to confirm.
9. At the end of the procedure, the EPS returns to normal operation, with the output not powered. Under these conditions the backlit indicator alternates green and orange colours.
10. Close the Trimod MCS door (the keys must not be left at the operator's disposal).

### 6.5 Battery drawers requirements

The battery drawers of the EPS and modular Trimod MCS BATTERY can be installed/replaced in two different ways in addition to the one with the EPS off described in paragraph 6.4.1.

#### INDICATION

**The battery drawers must always be added/removed in multiples of 4 (1 KB consists of four battery drawers for models with internal battery or external modular battery cabinets).** If a KB is added, start from the free slots at the bottom and covered with the plastic covers of the kit 3 108 65. If a KB is completely removed, cover the free slots with the empty battery slot covers of the kit 3 108 65.

If the installation/removal procedure changes the total number of KB installed, it is necessary to update this setting from the control panel.

After concluding the installation/replacement operations, calibrate the batteries from the control panel to get precise indications regarding the total autonomy of the EPS. To activate the function, enter the main menu and follow the path **Tools → Batteries → Batt. Calibration**.

Press the ENTER key to confirm the choice.

#### INDICATION

Always replace only 1 KB at a time

### 6.5.1 Installation/replacement of battery drawers with EPS in normal mode

If the EPS has in total more than 1 KB every 10kVA of power supplied on the output, it is possible to replace 4 battery drawers (1 KB) a time with the EPS in normal mode.

This operation can be carried out on models with internal batteries and on modular Trimod MCS BATTERY.

The replacement procedure is as follows:

1. Check that the equipment has installed more than 1KB every 10kVA of power supplied.
2. Check that the EPS is not functioning in battery mode and that the battery charger is in the "maintenance" or "standby" state. To check the status of the battery charger, go into the menu **UPS Status** → **Measures** → **Batteries** and check the fourth item shown on the screen.
3. Extract the four battery drawers relative to just one KB. To add another KB, do not remove any battery drawer.
4. Insert the four new battery drawers and fix them with the screws provided with them.
5. Repeat steps 2, 3 and 4 for every KB to install/replace.

#### INDICATION

If the EPS switches to battery mode during the operation, do not extract nor insert battery drawers. It is possible to resume the operation when the equipment returns to the normal mode.

If during the operation the input mains power fails, the autonomy is reduced: it is therefore necessary to carefully assess this circumstance in relation to the application before beginning the procedure.

### 6.5.2 Installation/replacement of battery drawers with EPS in maintenance manual bypass

This procedure is valid for both models with internal batteries and for modular Trimod MCS BATTERY.

1. Check that the procedure for placing in maintenance bypass mode, described in paragraph 6.4.2, has been applied.
2. Extract the four battery drawers relative to just one KB. To add another KB, do not remove any battery drawer.
3. Insert the four new battery drawers and fix them with the screws provided with them.
4. Repeat steps 2 and 3 for every KB to install/replace.
5. To leave the maintenance manual bypass status actuate the procedure described in paragraph 6.4.2.



#### CAUTION

During maintenance manual bypass operations, the load is supplied by the bypass input line and is not protected by the EPS

### 6.6 Extraordinary maintenance

Contact the LEGRAND Technical Support Service if faults have occurred which require access to internal parts of the EPS.

## 7. Warehousing



### **DANGER**

The warehousing operations must only be done by **SKILLED TECHNICIANS** (paragraph 2.2.1).



### **DANGER**

The **SKILLED TECHNICIAN** must check that there is no voltage present before disconnecting the cables. All the battery breakers on the EPS and on the external battery cabinets must be open. The modular Trimod MCS BATTERY battery drawers (if present) and the EPS battery drawers (according to the model) must be removed.

### **7.1 EPS**

The EPS may be stored in an environment with a temperature between -20°C (-4°F) and +50°C (+122°F) and humidity less than 90% (not condensing).

### **7.2 Batteries**

It is possible to store batteries without recharging them in the following conditions:

- up to 6 months if the temperature is between +20°C (+68°F) and +30°C (+86°F);
- up to 3 months if the temperature is between +30°C (+86°F) and +40°C (+104°F);
- up to 2 months if the temperature is over +40°C (+104°F).

For the recharging of the battery contact a qualified technician.



### **CAUTION**

The battery drawers or the external Trimod MCS BATTERY battery cabinets must never be stored if the batteries are partially or totally discharged.

LEGRAND is not liable for any damage or bad functioning caused to the EPS by wrong warehousing of the batteries.

## 8. Dismantling



**DANGER**

Dismantling and disposal operations must be carried out only by a **SKILLED TECHNICIAN** (paragraph 2.2.1). The instructions in this chapter are to be considered indicative: in every country there are different regulations with regard to the disposal of electronic or hazardous waste such as batteries. It is necessary to strictly adhere to the standards in force in the country where the equipment is used. Do not throw any component of the equipment in the ordinary rubbish.

### 8.1 Battery disposal

Batteries must be disposed of in a site intended for the recovery of toxic waste. Disposal in the traditional rubbish is not allowed.

Apply to the competent agencies in your country for the proper procedure.



Pb



**WARNING**

A battery may constitute a risk of an electric shock and high short-circuit current.

When working on batteries, the prescriptions indicated in chapter 2 must be adhered to.

### 8.2 EPS dismantling

The dismantling of the EPS must occur after the dismantling of the various parts it consists of.

For the dismantling operations, it is necessary to wear the Personal Protective Equipment mentioned in paragraph 2.3 and to consult the instructions and diagrams in this manual.

Sub-divide the components separating the metal from the plastic, from the copper and so on according to the type of selective waste disposal in the country where the machine is dismantled.

If the dismantled components must be stored before their disposal, be careful to keep them in a safe place protected from atmospheric agents to avoid soil and groundwater contamination.

### 8.3 Electronic component dismantling

For the disposal of electronic waste like the control panel or the command boards it is necessary to refer to the relevant standards.



This symbol indicates that at the end of its life the product is collected separately from other waste and taken to authorised collection centres, in the cases and ways laid down by the national laws of EU countries, to avoid negative effects for the environment and human health. Unauthorised disposal at the end of life is subject to legal penalties. It is recommended to check that this equipment subject to WEEE legislations in the country where it is used.

## 9. Technical data

### Main features

	Trimod MCS 3	Trimod MCS 5	Trimod MCS 7	Trimod MCS 10	Trimod MCS 15	Trimod MCS 20	Trimod MCS 30	Trimod MCS 40	Trimod MCS 60	Trimod MCS 80
Rated power at 120% of the load (EN50171)	3.4 kVA	5 kVA	6.7 kVA	10 kVA	15 kVA	20 kVA	30 kVA	40 kVA	60 kVA	80 kVA
Active power at 120% of the load (EN50171)	3.4 kW	5 kW	6.7 kW	10 kW	15 kW	20 kW	30 kW	40 kW	60 kW	80 kW
Active power at 100% of the load	2.83 kW	4.16 kW	5.58 kW	8 kW	12.5 kW	16.7 kW	25 kW	33.3 kW	50 kW	66.7 kW
Technology	Classification according to EN62040-3: VFI-SS-111									
IN/OUT Configuration	Single-phase / Single-phase			Single-phase / Single-phase – Single-phase / Three-phase Three-phase / Single-phase - Three- phase / Three-phase (may be configured by a skilled technician)				Three-phase / Three-phase		
Dual Input	Available on all the models									
Command boards	1									
EPS architecture	Modular with power modules PF=1 Expandable, redundant N+X									
Neutral system	Neutral passing straight from input to output (not isolated)									
Bypass	Automatic (static and electromechanical) Manual (for maintenance)									
Protection class	I									
Overvoltage category	OVC II									

### Input electrical characteristics

	Trimod MCS 3	Trimod MCS 5	Trimod MCS 7	Trimod MCS 10	Trimod MCS 15	Trimod MCS 20	Trimod MCS 30	Trimod MCS 40	Trimod MCS 60	Trimod MCS 80
Maximum three-phase/ three-phase current	-	-	-	19.2 A	28.8 A	38.4 A	57.6 A	76.8 A	115.2 A	153.6 A
Maximum three-phase/ single-phase current	-	-	-	19.2 A	28.8 A	38.4 A	57.6 A	-	-	-
Maximum single phase/single phase current	-	-	-	57.6 A	86.4 A	115.2 A	172.8 A	-	-	-
Maximum single- phase/single-phase current	19.5 A	28.7 A	38.5 A	57.6 A	86.4 A	115.2 A	172.8 A	-	-	-
Rated input voltage	230 V + 15% - 20% (Single-phase)			230 V + 15% - 20% (Single-phase) 400 V + 15% - 20% (Three-phase) (neutral line indispensable)				400 V + 15% - 20% (Three-phase) (neutral line indispensable)		
Bypass frequency	50 / 60 Hz ± 2% 50 / 60 Hz ± 14 % (autosensing and/or selectable by the user)									
Power factor on input	> 0.99									
Total harmonic distortion of the input current	THDi < 3%									



**Electrical output characteristics (normal mode)**

	Trimod MCS 3	Trimod MCS 5	Trimod MCS 7	Trimod MCS 10	Trimod MCS 15	Trimod MCS 20	Trimod MCS 30	Trimod MCS 40	Trimod MCS 60	Trimod MCS 80
Maximum three-phase/ three-phase current	-	-	-	14.5 A	21.7 A	29 A	43.5 A	58 A	87 A	116 A
Maximum three-phase/ single-phase current	-	-	-	43.5 A	65.2 A	87 A	130.5 A	-	-	-
Maximum single phase/single phase current	-	-	-	14.5 A	21.7 A	29 A	43.5 A	-	-	-
Maximum single- phase/single-phase current	14.8 A	21.7 A	29.2 A	43.5 A	65.2 A	87 A	130.5 A	-	-	-
Rated output voltage	230 V ± 1% (Single-phase)			230 V ± 1% (Single-phase) 400 V ± 1% (Three-phase)				400 V ± 1% (Three-phase)		
Rated output frequency	50 / 60 Hz									
Tolerance on the output frequency	If synchronised with the input frequency: adjustable range from ±1% to ±14% If not synchronised: ± 0.1%									
Crest factor admitted on the output current	3:1									
Efficiency (AC/AC on-line)	up to 96%									
Efficiency ECO mode	99% max									
Overload admitted	120% continuously without automatic bypass intervention 135% for 10 minutes without automatic bypass intervention 150% for 60 seconds without automatic bypass intervention									

**Electrical output characteristics (battery mode)**

	Trimod MCS 3	Trimod MCS 5	Trimod MCS 7	Trimod MCS 10	Trimod MCS 15	Trimod MCS 20	Trimod MCS 30	Trimod MCS 40	Trimod MCS 60	Trimod MCS 80
Rated output voltage	230 V ± 1% (Single-phase)			230 V ± 1% (Single-phase) 400 V ± 1% (Three-phase)				400 V ± 1% (Three-phase)		
Rated output frequency	50 / 60 Hz ± 1%									
Total harmonic distortion of output voltage on non-linear nominal load	< 1%									
Overload admitted	120% until end of autonomy 135% for 2 minutes 155% for 30 seconds									

## 9. Technical data

### Batteries and Battery Charger Characteristics

	Trimod MCS 3	Trimod MCS 5	Trimod MCS 7	Trimod MCS 10	Trimod MCS 15	Trimod MCS 20	Trimod MCS 30	Trimod MCS 40	Trimod MCS 60	Trimod MCS 80
Battery type	Long-life maintenance-free sealed lead-acid (VRLA); life expectancy 10 years									
Unitary capacity	Battery drawers: 5 batteries 12Vdc - 9Ah Non-modular external battery cabinets: 20 batteries 12Vdc - 94Ah									
Rated battery voltage	240 Vdc (20 batteries 12V in series)									
Type of battery charger	High performance PWM, one for each power module									
Recharge curve	Smart Charge, advanced three-stage cycle									
Battery charger nominal recharge current	2.5 A max for every power module installed									
Charging time (EN50171)	12 h max									

	3 109 90 Trimod MCS 3	3 109 91 Trimod MCS 5	3 109 92 Trimod MCS 7	3 109 93 Trimod MCS 10	3 109 94 Trimod MCS 15	3 109 95 Trimod MCS 20	3 109 96 Trimod MCS 30	3 109 97 Trimod MCS 40	3 109 98 Trimod MCS 60	3 109 99 Trimod MCS 80
Minimum number of batteries to guarantee an autonomy of 1 h (EN50171) *	8 battery drawers	12 battery drawers	16 battery drawers	24 battery drawers (12 in the EPS + 12 in the external modular battery cabinet 4KB)	36 battery drawers (16 in the EPS + 20 in the external modular battery cabinet 5KB)	1 external non-modular battery cabinet	2 external non-modular battery cabinet	2 external non-modular battery cabinet	3 external non-modular battery cabinet	4 external non-modular battery cabinet

\*1h autonomy only guaranteed for the item codes listed in the table

### Features

	Trimod MCS 3	Trimod MCS 5	Trimod MCS 7	Trimod MCS 10	Trimod MCS 15	Trimod MCS 20	Trimod MCS 30	Trimod MCS 40	Trimod MCS 60	Trimod MCS 80
Signals and alarms	Large four line alphanumeric screen, multicolour status indicator, acoustic notification									
Communication ports	2 x RS 232 ports, 1 relay interface, 1 contact port, 1 SMNP module slot									
Protections	Electronics against overloads, short-circuit and excessive battery discharge Block of functions due to the end of autonomy In-rush limiter on start up EPO contact Auxiliary contact for Backfeed protection									

**Mechanical characteristics**

	3 110 00 Trimod MCS 3	3 110 00 Trimod MCS 5	3 110 00 Trimod MCS 10	3 110 01 Trimod MCS 20	3 110 03 Trimod MCS 30	3 110 04 Trimod MCS 40	3 110 05 Trimod MCS 60
Net weight (without batteries and power modules)	87 kg			90 kg	86 kg	83 kg	92 kg
Dimensions in mm (w x h x d)	414 x 1370 x 628						
3400 VA power modules installed	1	-	3	-	-	-	-
5000 VA power modules installed	-	1	-	-	6	-	-
6700 VA power modules installed	-	-	-	3	-	6	9
Power module net weight	8.5 kg						
Battery drawer net weight	13.3 kg			-	-	-	-

	3 110 02 Trimod MCS 7	3 110 02 Trimod MCS 15	3 110 06 Trimod MCS 80
Net weight (without batteries and power modules)	105 kg		122 kg
Dimensions in mm (w x h x d)	414 x 1650 x 628		
3400 VA power modules installed	-	-	-
5000 VA power modules installed	-	3	-
6700 VA power modules installed	1	-	12
Power module net weight	8.5 kg		
Battery drawer net weight	13.3 kg		-

	3 110 07 Trimod MCS Battery Cabinet 4KB	3 106 16 Trimod MCS Battery Cabinet 5KB	3 108 08 3 108 09 3 108 10 3 108 11 Trimod Battery Cabinet 94Ah
Net weight (without batteries)	82 kg	96 kg	100 kg
Dimensions in mm (w x h x d)	414 x 1370 x 628	414 x 1650 x 628	600 x 1635 x 800
Battery drawers weight	13.3 kg		-
Weight of each 94Ah battery	-		32.6 kg

## 9. Technical data

### Environmental conditions

	Trimod MCS 3	Trimod MCS 5	Trimod MCS 7	Trimod MCS 10	Trimod MCS 15	Trimod MCS 20	Trimod MCS 30	Trimod MCS 40	Trimod MCS 60	Trimod MCS 80
Operating temperature	0 ÷ 40 °C									
Relative humidity during operation	0%÷95% non condensing									
Storage temperature	-20°C ÷ 50 °C (excluding batteries)									
Noise level at 1 metre	58 ÷ 62 dB									
Pollution degree	PD2									
Environmental category (EN60721-3-3)	3K2									
Mechanical category (EN60721-3-3)	3M1									
Protection index	IP 20									
Operating height	up to 1000 metres above sea level without derating									

### Trimod MCS 3 108 51 battery charger module (BCM) technical specifications

Rated input voltage	230 Vac + 15% - 20%
Rated input current	19.3 A
Input Power Factor	PF > 0.99
Total harmonic distortion of the input current	THDi < 3%
Rated output voltage	240/252 Vdc
Output voltage in maintenance phase	13.75 Vdc per battery
Rated output current	15 Adc max
AC/DC performance	>93% at max rated output current
Functioning status indications (signalled by multicoloured LED on module and indications on the display)	Yellow LED, fast flashing: recharge phase f1 Green LED, slow flashing: recharge phase f2 and maintenance Green LED steady: standby Red LED: fault status

### Reference directives and standards

Marks	CE, EAC, CMIN
CPSS	EN 50171
Safety	2014/35/EU directive EN 62040-1
EMC	2014/30/EU directive EN 62040-2
Performance and test requirements	EN 62040-3

## 10. Tables



### CAUTION

The choice of the type and section of the connecting wires depending on their voltage, rated current and installation must be done as indicated in the standards in force in the country where the EPS is installed and it is a responsibility of the installation engineer.

The input current and the output power of the EPS are indicated in chapter 9 and the battery current in table 8 of this chapter.

The following tables give an indication of the wire cross sections to use if the wires are unipolar with simple PVC installation and installation in tube in the air.

**TABLE 1**

Minimum cable cross sections recommended for Trimod MCS

POWER	INPUT PHASES	OUTPUT PHASES	INPUT CABLE	BYPASS CABLE (in case of separate bypass line)	OUTPUT CABLE
3 kVA	1	1	3 x 2.5 mm <sup>2</sup>	3 x 2.5 mm <sup>2</sup>	3 x 2.5 mm <sup>2</sup>
5 kVA	1	1	3 x 4 mm <sup>2</sup>	3 x 4 mm <sup>2</sup>	3 x 4 mm <sup>2</sup>
7 kVA	1	1	3 x 6 mm <sup>2</sup>	3 x 6 mm <sup>2</sup>	3 x 6 mm <sup>2</sup>
10 kVA	3	3	5 x 4 mm <sup>2</sup>	5 x 4 mm <sup>2</sup>	5 x 4 mm <sup>2</sup>
	1	1	3 x 10 mm <sup>2</sup>	3 x 10 mm <sup>2</sup>	3 x 10 mm <sup>2</sup>
	1	3	3 x 10 mm <sup>2</sup>	3 x 10 mm <sup>2</sup>	5 x 4 mm <sup>2</sup>
	3	1	5 x 10 mm <sup>2</sup>	5 x 10 mm <sup>2</sup>	3 x 10 mm <sup>2</sup>
15/20 kVA	3	3	5 x 10 mm <sup>2</sup>	5 x 10 mm <sup>2</sup>	5 x 10 mm <sup>2</sup>
	1	1	3 x 25 mm <sup>2</sup>	3 x 25 mm <sup>2</sup>	3 x 25 mm <sup>2</sup>
	1	3	3 x 25 mm <sup>2</sup>	3 x 25 mm <sup>2</sup>	5 x 10 mm <sup>2</sup>
	3	1	5 x 25 mm <sup>2</sup>	5 x 25 mm <sup>2</sup>	3 x 25 mm <sup>2</sup>
30 kVA	3	3	5 x 16 mm <sup>2</sup>	5 x 16 mm <sup>2</sup>	5 x 16 mm <sup>2</sup>
	1	1	3 x 50 mm <sup>2</sup>	3 x 50 mm <sup>2</sup>	3 x 50 mm <sup>2</sup>
	1	3	3 x 50 mm <sup>2</sup>	3 x 50 mm <sup>2</sup>	5 x 16 mm <sup>2</sup>
	3	1	5 x 50 mm <sup>2</sup>	5 x 50 mm <sup>2</sup>	3 x 50 mm <sup>2</sup>
40 kVA	3	3	5 x 25 mm <sup>2</sup>	5 x 25 mm <sup>2</sup>	5 x 25 mm <sup>2</sup>
60 kVA	3	3	5 x 35 mm <sup>2</sup>	5 x 35 mm <sup>2</sup>	5 x 35 mm <sup>2</sup>
80 kVA	3	3	5 x 50 mm <sup>2</sup>	5 x 50 mm <sup>2</sup>	5 x 50 mm <sup>2</sup>

### INDICATION

The maximum cable cross section that can be installed in the terminals is 70 mm<sup>2</sup> for all the models.

**TABLE 2**

Battery fuse values recommended for Trimod MCS with internal batteries

POWER	BATTERY FUSES	
	Trimod MCS	
	F B+	F B-
3/5/7/10/15 kVA	50A 400V gG (14 x 51 mm)	50A 400V gG (14 x 51 mm)

## 10. Tables

**TABLE 3**

Battery fuse values recommended for MODULAR Trimod MCS BATTERY 4KB

POWER	BATTERY FUSES	
	MODULAR Trimod MCS BATTERY 4KB (16 drawers)	
	F B+	F B-
3/5/7/10 kVA	n°4 – 50A 500V gG (14 x 51 mm)	n°4 – 50A 500V gG (14 x 51 mm)

**TABLE 4**

Battery fuse values recommended for MODULAR Trimod MCS BATTERY 5KB

POWER	BATTERY FUSES	
	MODULAR Trimod MCS BATTERY 5KB (20 drawers)	
	F B+	F B-
3/5/7/10/15 kVA	No. 5 – 50A 500V gG (14 x 51 mm)	No. 5 – 50A 500V gG (14 x 51 mm)

**TABLE 5**

Battery fuse values recommended for NON MODULAR Trimod BATTERY 1KB (94Ah)

POWER	BATTERY FUSES	
	NON MODULAR Trimod BATTERY 1KB (94Ah)	
	F B+	F B-
20 kVA	No. 1 – 100A 500V gG (22 x 58 mm)	No. 1 – 100A 500V gG (22 x 58 mm)
30 kVA	No. 2 – 80A 500V gG (22 x 58 mm)	No. 2 – 80A 500V gG (22 x 58 mm)
40 kVA	No. 2 – 125A 500V gG (22 x 58 mm)	No. 2 – 125A 500V gG (22 x 58 mm)
60 kVA	No. 3 – 100A 500V gG (22 x 58 mm)	No. 3 – 100A 500V gG (22 x 58 mm)
80 kVA	n°4 – 100A 500V gG (22 x 58 mm)	n°4 – 100A 500V gG (22 x 58 mm)

**TABLE 6**  
Automatic breaker recommended for mains input and bypass line

POWER	INPUT PHASES	OUTPUT PHASES	RECOMMENDED AUTOMATIC CIRCUIT BREAKER	RECOMMENDED INPUT FUSE
3 kVA	1	1	C curve 20A (2P)	20A gG
5 kVA	1	1	C curve 32A (2P)	32A gG
7 kVA	1	1	C curve 40A (2P)	40A gG
10 kVA	3	3	C curve 20A (3P+N)	20A gG
	3	1	C curve 63A (3P+N)	63A gG
	1	1-3	C curve 63A (1P+N)	63A gG
15kVA	3	3	C curve 32A (3P+N)	32A gG
	3	1	C curve 100A (3P+N)	100A gG
	1	1-3	C curve 100A (1P+N)	100A gG
20 kVA	3	3	C curve 40A (3P+N)	32A gG
	3	1	C curve 100A (3P+N)	100A gG
	1	1-3	C curve 100A (1P+N)	100A gG
30 kVA	3	3	C curve 63A (3P+N)	63A gG
	3	1	C curve 160A (3P+N)	160A gG
	1	1-3	C curve 160A (1P+N)	160A gG
40 kVA	3	3	C curve 80A (3P+N)	63A gG
60 kVA	3	3	C curve 100A (3P+N)	100A gG
80 kVA	3	3	C curve 150A (3P+N)	125A gG

**TABLE 7**  
Residual current breaker recommended for mains input and bypass line

POWER	RESIDUAL CURRENT BREAKER RESIDUAL CURRENT ( $I_{\Delta n}$ )
3 kVA	$\geq 30$ mA B type
5 kVA	$\geq 30$ mA B type
7 kVA	$\geq 30$ mA B type
10 kVA	$\geq 300$ mA B type
15 kVA	
20 kVA	
30 kVA	
40 kVA	
60 kVA	
80 kVA	

## 10. Tables

**TABLE 8**

Maximum current absorbed by the batteries at 100% of the load and minimum wire cross sections recommended for connection of the EPS to the external Trimod MCS BATTERY battery cabinets.

POWER	MAXIMUM BATTERY CURRENT	RECOMMENDED MINIMUM WIRE CROSS SECTION
3 kVA	16 A	1 x 10 mm <sup>2</sup> for each pole
5 kVA	27 A	1 x 10 mm <sup>2</sup> for each pole
7 kVA	38 A	1 x 10 mm <sup>2</sup> for each pole
10 kVA	50 A	1 x 10 mm <sup>2</sup> for each pole
15 kVA	76 A	1 x 16 mm <sup>2</sup> for each pole
20 kVA	100 A	1 x 25 mm <sup>2</sup> for each pole
30 kVA	152 A	2 x 25 mm <sup>2</sup> for each pole
40 kVA	202 A	2 x 35 mm <sup>2</sup> for each pole
60 kVA	304 A	2 x 50 mm <sup>2</sup> for each pole
80 kVA	405 A	2 x 70 mm <sup>2</sup> for each pole



# 11. Wiring Diagrams

## 11.1 Block diagram of interconnections and distributions of the EPS

The following figure shows the block diagram of a Trimod MCS 60 distribution. The layout is similar for all the other models. The bypass input terminals are represented according to the factory configuration (bypass input line in common).

CABINET DISTRIBUTION

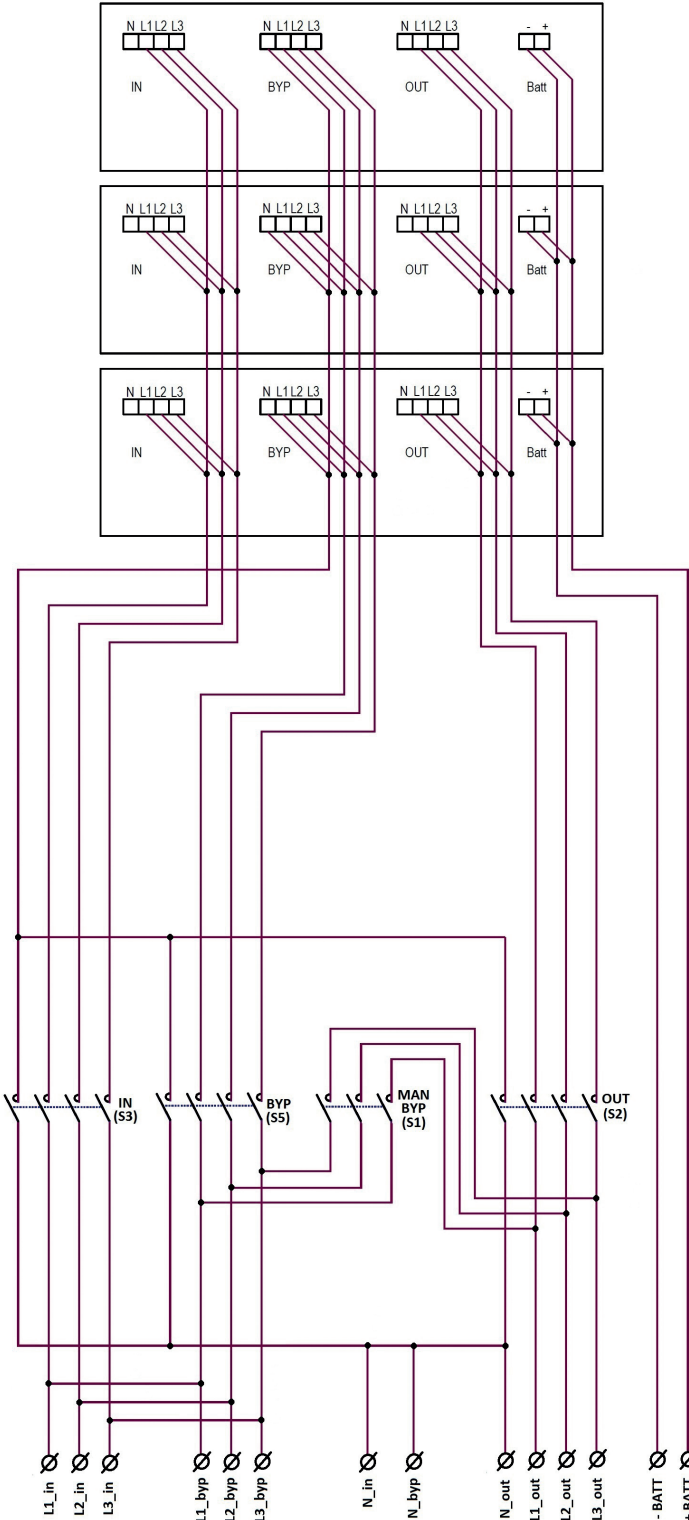

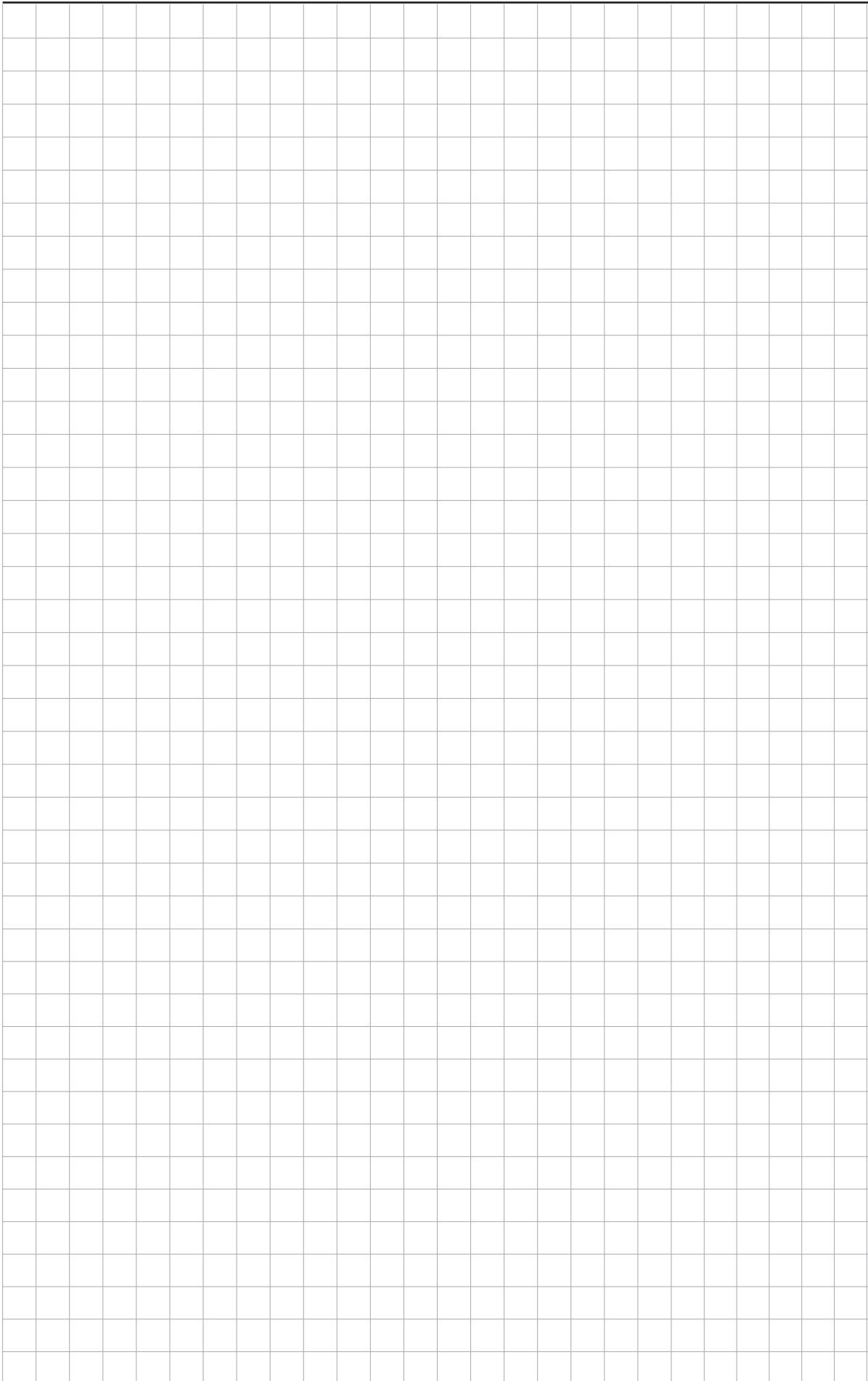

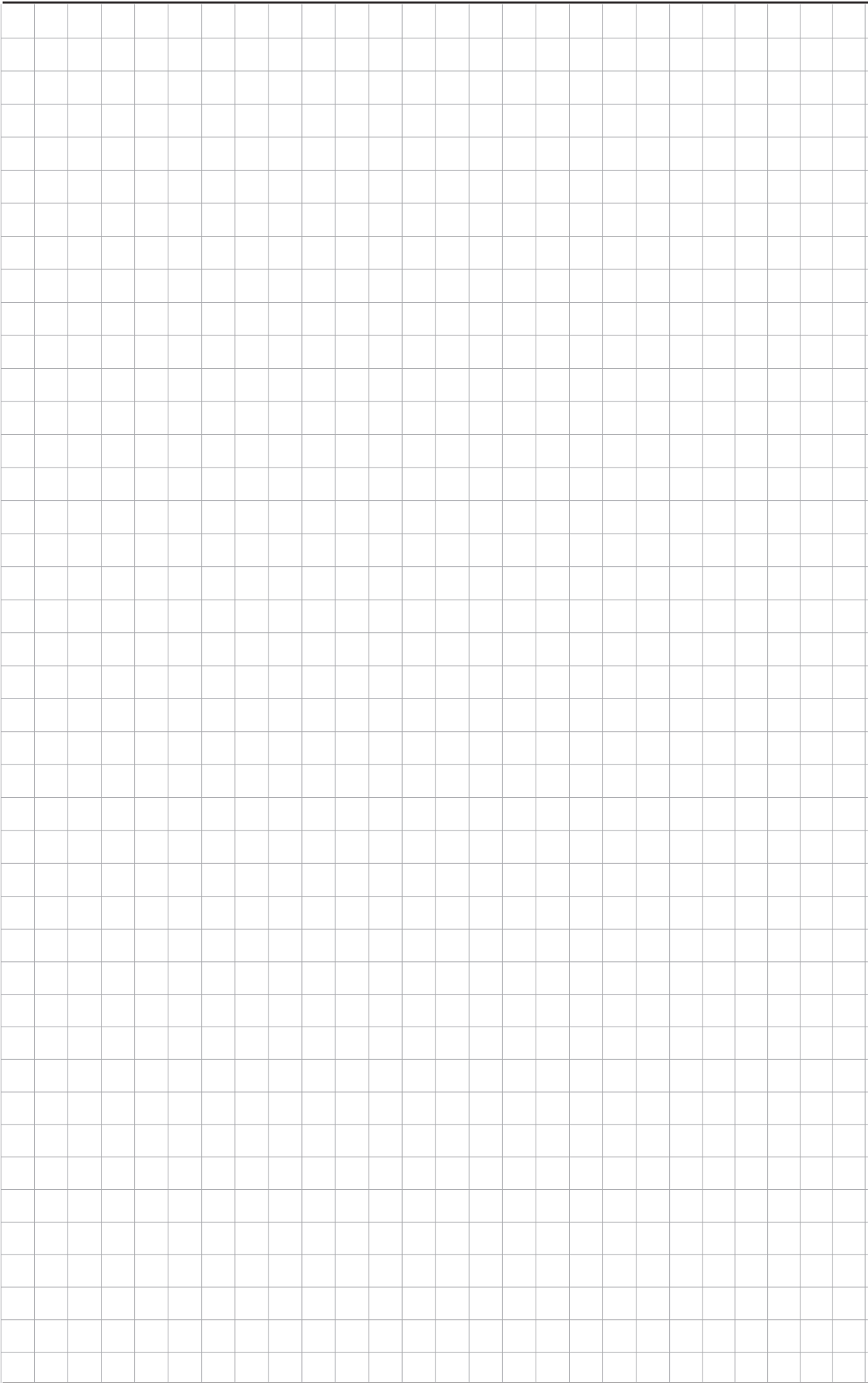

LEGRAND  
Pro and Consumer Service  
BP 30076 - 87002  
LIMOGES CEDEX FRANCE  
[www.legrand.com](http://www.legrand.com)

┌ Installer stamp ─┐

└ ─────────────────┘