



Trimod MCS

UK

ENGLISH

3



Contents

1	Introduction	5
1.1	General information	5
1.2	Purpose of the manual	5
1.3	Symbols in the manual	6
1.4	Where and how to keep the manual	6
1.5	Update of the manual	6
1.6	Manufacturer's liability and guarantee	6
1.6.1	Guarantee terms	7
1.6.2	Guarantee extension and maintenance contracts	7
1.7	Copyright	7
2	Regulatory and safety requirements	8
2.1	General notes	8
2.2	Definitions of "Skilled Technician" and "Operator"	8
2.2.1	Skilled Technician	8
2.2.2	Operator	8
2.3	Personal Protective Equipment	9
2.4	Hazard signs in the workplace	9
2.5	Signs on the equipment	9
2.6	General warnings	10
2.7	How to proceed in an emergency	11
2.7.1	First-aid procedures	11
2.7.2	Fire procedures	11
3	Technological description	12
3.1	Trimod MCS technology	12
3.2	Features	14
3.3	Models	16
3.4	Block diagram of interconnections and distributions of the EPS	20
4	Unpacking and positioning	21
4.1	Visual check	21
4.1.1	Equipment and supplied accessories check	21
4.2	Unpacking	21
4.3	Check of the content	21
4.4	Movement	22
4.5	Positioning constraints	22
4.6	Final operations	22
5	Communication devices	23
5.1	RS232 serial ports	23
5.2	Contact interface	24
5.3	Emergency Power Off (EPO)	24
5.4	Logic level interface	25
5.5	Network card (SNMP) slot	26

Contents

6	Control panel	27
6.1	Description	27
6.2	Service Mode	28
6.3	Main screen	28
6.4	Main menu and submenu	30
6.4.1	UPS Status	31
6.4.2	UPS Setup	33
6.4.3	Power Modules	37
6.4.4	Events	39
6.4.5	Tools	39
6.4.6	Log Out	39
6.5	POWER ON/OFF menu	40
6.6	Switching off the EPS	40
6.7	Switching on the EPS	40
7	Diagnosis	41
7.1	Luminous and audible notifications	41
7.2	Messages	43
8	Installation and maintenance	50
8.1	Introduction	50
8.2	Installation	50
8.3	Preventive maintenance	50
8.4	Periodical checks	50
8.5	Ordinary maintenance	50
8.6	Extraordinary maintenance	50
9	Warehousing	51
9.1	EPS	51
9.2	Batteries	51
10	Dismantling	52
10.1	Battery disposal	52
10.2	EPS dismantling	52
10.3	Electronic component dismantling	52
11	Technical data	53

1. Introduction



CAUTION

The instructions in this manual are intended for an OPERATOR (paragraph 2.2.2)

1.1 General information

Congratulations on your LEGRAND TRIMOD MCS EPS purchase.

Thanks to this EPS, your critical equipment will always be protected by a constant and reliable electricity supply.

LEGRAND is specialized in designing and producing EPS. Trimod MCS is unique in its kind: it is modular, redundant and belongs to the last generation of medium power EPS.

High reliability, low running costs and excellent electrical performance are some of its features. The high quality standard of LEGRAND in design and production allows Trimod MCS to pass the strictest quality tests.

The EPS has been designed in compliance with the existing European Union directives, with the technical standards that include their requirements and with the eco-design guidelines.

The equipment is produced at an ISO14001 certified factory.

This publication, simply defined “user manual” herein, contains all the information for the use of the Trimod MCS EPS, also referred to as “equipment” in this manual.

The contents of the user manual are intended mainly for an operator (see paragraph 2.2.2) or for people, generically defined as “users”, who have the need and/or obligation to provide instructions or work directly on the equipment for their assigned tasks.

These people can be the following:

- managers;
- heads of operating areas;
- department heads;
- direct private users.

The original text of this publication, drafted in Italian, is the only reference for the resolution of disputes of interpretation linked to translations into other languages.

1.2 Purpose of the manual

The purpose of this manual is to provide the operator with instructions for safely using the equipment after the installation performed by a skilled technician.

Any adjustments and extraordinary maintenance operations are not dealt with in this manual because they are the sole preserve of the LEGRAND Technical Support Service.

The reading of this manual is essential but does not substitute the skill of the technician who must have received adequate preliminary training.

The intended use and configurations envisaged for the equipment and shown in this manual are the only ones allowed by the Manufacturer.

Any other use or configuration must be previously agreed with the Manufacturer in writing and, in this case, the written agreement will be attached to the installation and user manual.

This manual also makes reference to laws, directives and standards that the operator is required to be aware of and consult.

1. Introduction

1.3 Symbols in the manual

Some operations are shown in graphic symbols that draw the attention of the reader to the danger or the importance they imply:



This indication shows a danger entailing a high degree of risk that, if not avoided, will lead to death or serious injury or considerable damage to the equipment and the things around it.



This indication shows a danger entailing a medium degree of risk that, if not avoided, could lead to death or serious injury or considerable damage to the equipment and the things around it.



This indication shows a danger entailing a low level of risk that, if not avoided, could lead to minor or moderate injury or material damage to the equipment and the things around it.

INDICATION

This symbol indicates important information which should be read carefully.

1.4 Where and how to keep the manual

This manual must be kept in a safe, dry place and must always be available for consultation.

It is recommended to make a copy of it and file it away.

If information is exchanged with the Manufacturer or the authorised assistance personnel, it is essential to refer to the equipment's rating plate data and serial number.

INDICATION

The supplied manuals are an integral part of the equipment and must therefore be kept for their entire lifetime.

In case of need (for example in case of damage that even partially compromise the consultation) the operator is required to get a new copy from the Manufacturer, quoting the publication code on the cover.

1.5 Update of the manual

The manual reflects the state of the art when the equipment was put onto the market. The publication conforms with the directives current on that date. The manual cannot be considered inadequate when new standards come into force or modifications are made to the equipment.

Any addition the Manufacturer considers appropriate to send to the users, must be kept together with the manual of which they will become an integral part.

The updated version of the manual is available on the Internet at <http://www.ups.legrand.com>

1.6 Manufacturer's liability and guarantee

The skilled technician and the operator shall scrupulously comply with the precautions indicated in the manuals. In particular they must:

- always work within the operating limits of the equipment;
- always carry out constant and careful maintenance through a skilled technician who complies with all the procedures indicated in the installation and maintenance manual.

The Manufacturer declines all indirect or direct responsibility arising from:

- installation and wiring completed by personnel not possessing the qualifications required by the regulations of the country of installation for working on equipment operating on dangerous voltages;
- installation and wiring completed by personnel not wearing the Personal Protective Equipment required by the regulations of the country of installation;
- failure to observe the installation, maintenance instructions and use of the equipment which differs from the specifications in the user manual;
- use by personnel who have not read and thoroughly understood the content of the user manual;
- use that does not comply with the specific standards used in the country where the equipment is installed;
- modifications made to the equipment, software, operating logic unless they have been authorised by the Manufacturer in writing;

- repairs that have not been authorised by the LEGRAND Technical Support Service;
- damage caused intentionally, through negligence, by acts of God, natural phenomena, fire or liquid infiltration.
- damage caused by the use of batteries or protections other than those indicated in the installation and maintenance manual;
- damage caused by failure to install or establish the safety protections indicated in the manuals, or by failure to comply with the safety labels.

Transfer of the equipment to others also requires the handing over of all the manuals. Failure to hand over the manuals shall automatically nullify any right of the buyer, including the terms of the guarantee where applicable.

If the equipment is sold to another party in a country where a different language is spoken, the original owner shall be responsible for providing a faithful translation of the manuals in the language of the country where the equipment will be used.

1.6.1 Guarantee terms

The terms of the guarantee may vary depending on the country where the EPS is sold. Check the validity and duration with LEGRAND's local sale representative.

If there should be a fault in the equipment, contact the LEGRAND Technical Support Service which will provide all the instructions on what to do.

Do not send anything back without LEGRAND's prior authorization.

The guarantee becomes void if the EPS has not been brought into service by a properly trained skilled technician (see paragraph 2.2.1).

If during the guarantee period the EPS does not conform with the characteristics and performance laid down in this manual, LEGRAND at its discretion will repair or replace the EPS and relative parts.

All the repaired or replaced parts will remain LEGRAND's property.

LEGRAND is not responsible for costs such as:

- losses of profits or earnings;
- losses of equipment, data or software;
- claims by third parties;
- any damage to persons or things due to improper use, unauthorized technical alterations or modifications;
- any damage to persons or things due to installations where the full compliance with the standard regulating the specific usage applications have not been guaranteed.

1.6.2 Guarantee extension and maintenance contracts

The standard guarantee can be consolidated in an extension contract (maintenance contract).

Once the guarantee period has passed, LEGRAND is available for giving a technical assistance service able to meet all requirements, maintenance agreements, 24/7 availability and monitoring.

For more information contact the LEGRAND Technical Support Service.

1.7 Copyright

The information contained in this manual cannot be disclosed to any third party. Any partial or total duplication of the manual by photocopying or other systems, including electronic scanning, which is not authorised in writing by the Manufacturer, violates copyright conditions and may lead to prosecution.

LEGRAND reserves the copyright of this publication and prohibits its reproduction wholly or in part without previous written authorisation.

2. Regulatory and safety requirements



DANGER

Before carrying out any operation on the equipment, it is necessary to read the entire manual carefully, especially this chapter.

Look after this manual carefully and consult it repeatedly while using the EPS.

2.1 General notes

The equipment has been made for the applications given in the manuals. It may not be used for purposes other than those for which it has been designed, or differently from those specified.

2.2 Definitions of "Skilled Technician" and "Operator"

2.2.1 Skilled Technician

The professional figure who will carry out the installation, start up and ordinary maintenance is called "Skilled Technician". This definition refers to people who have specific technical qualification and are aware of the method of installing, assembling, repairing, commissioning and safe use of the equipment.

In addition to the requirements listed in the paragraph below for general operators, the Skilled Technician must be qualified in accordance with the safety regulations in force in the country of installation on the measures to implement when working in presence of hazardous voltage. He must also use the Personal Protective Equipment required by the safety regulations in force at the country of installation for all the activities indicated in the installation and maintenance manual (see paragraph 2.3)



WARNING

The safety manager is responsible for protection and company risks prevention according to what is indicated in the European directives 2007/30/EC and 89/391/EEC regarding safety in the workplace.

The safety manager must ensure that all the people working on the equipment have received all the instructions included in the manuals with particular reference to those contained in this chapter.

2.2.2 Operator

The professional figure assigned to the equipment for normal use is called "Operator".

This definition refers to people who know how to operate the equipment as described in the user manual and have the following requisites:

1. technical education, which enables them to operate according to safety standards in relation to the dangers linked to the presence of electric current;
2. training on the use of Personal Protective Equipment and basic first aid interventions.

The company safety manager in choosing the person (operator) who uses the equipment, must consider:

- the person's work fitness according to the laws in force;
- the physical aspect (not disabled in any way);
- the psychological aspect (mental stability, sense of responsibility);
- the educational background, training and experience;
- the knowledge of the standards, regulations and measures for accident prevention.

He should also impart training in such a way as to provide thorough knowledge of the equipment and its component parts.

The operator shall consult the user manual at any time. He shall also follow the requirements provided to achieve maximum safety for himself and others during all operating phases.

Some typical activities the operator is expected to carry out are:

- the use of the equipment in its normal operating status and the restore of the functioning after it shuts down;
- the activation of the necessary provisions for maintaining the quality performance of the EPS;
- the cleaning of the equipment;
- cooperation with personnel responsible for ordinary maintenance activities (skilled technicians).

2.3 Personal Protective Equipment



DANGER

The equipment poses a considerable risk of electric shock and a high short circuit current. During use and maintenance operations, it is forbidden to operate without the equipment listed in this paragraph.

People responsible for operating this equipment and/or passing close to it must not wear garments with flowing sleeves, nor laces, belts, bracelets or other metal pieces that might cause a danger.

The following signs sum up the minimum Personal Protective Equipment to wear at all times. Additional requirements may be provided for by the safety regulations in force in the country of installation.



Anti-accident and no-spark shoes with rubber sole and reinforced toe



Safety gloves for protection from mechanical risks



Dielectric gloves for protection from dangerous voltages



Protective clothing for electrical work



Electrical protection helmet and visor



1000 V Insulated tools

2.4 Hazard signs in the workplace

The following signs must be exhibited at all points of access to the room where the equipment is installed:



Electric current

This sign indicates the presence of electrical live parts.



How to proceed in an emergency

Do not use water to quench fires but just the extinguishers specifically designed for putting out fires in electrical equipment.



No smoking

This sign indicates that smoking is not allowed.

2.5 Signs on the equipment

Displayed on the equipment are explanatory plates that can vary depending on the country the equipment is intended for and constructional standards applied.

Make sure the instructions are adhered to. It is strictly prohibited to remove these plates and to work in a way that differs from what is written there.

The plates must always be clearly read and they must be cleaned periodically.

If a plate deteriorates and/or it is no longer legible, even partially, the Manufacturer must be contacted for another one in order to replace it.

2. Regulatory and safety requirements

CAUTION

The plates must not be removed or covered. No other plates may be affixed to the equipment without the Manufacturer's prior written authorisation.

WARNING

Potential risks can be drastically reduced by wearing the Personal Protective Equipment listed in this chapter. These protections are indispensable. Always operate with due care around dangerous areas marked by the appropriate warning signs on the equipment.

2.6 General warnings

DANGER

The EPS works with dangerous voltages. Only SKILLED TECHNICIANS must perform the installation and ordinary maintenance operations. No part of the EPS can be repaired by the operator.

Extraordinary maintenance operations must be carried out by LEGRAND Technical Support Service personnel.

WARNING

A battery can present a risk of electrical shock and high short circuit current. The following precautions should be observed when working on batteries:

- a) remove watches, rings or other metal objects;
- b) use tools with insulated handles;
- c) wear rubber gloves and boots;
- d) do not lay tools or metal parts on top of batteries;
- e) disconnect the charging source prior to connecting or disconnecting battery terminals;
- f) determine if battery is inadvertently grounded. If inadvertently grounded, remove source from ground. Contact with any part of a grounded battery can result in electrical shock. The likelihood of such shock can be reduced if the ground connections are removed during installation and maintenance (applicable to remote equipment and battery supplies without a grounded supply circuit).
- g) never leave powered cables uncovered.

Do not dispose of batteries in a fire. The batteries may explode.

Do not open or mutilate batteries. Released electrolyte is harmful to the skin and eyes.

The batteries installed inside the cabinet must be disposed of correctly. For the disposal requirements refer to local laws and relevant standards.

CAUTION

The EPS works with TT and TN systems. It has a pass-through neutral architecture: the status of the output neutral is the same as the input neutral.

When the output load needs a different neutral status from the input status, it is necessary to place downstream of the EPS a suitably scaled isolation transformer protected in compliance with the standards in force.

CAUTION

Do not open the battery fuse holders while the EPS is powering the loads in battery mode.

WARNING

To reduce the risk of fire or electric shock, the EPS must work in clean and indoor environments with controlled temperature and humidity. It must be kept away from inflammable liquids and corrosive substances. The room temperature must not be above +40°C (+104°F) and the relative humidity must be a maximum of 95% not condensing.

**CAUTION**

The equipment generates, uses and can radiate radio frequency energy. If it is not installed and used in accordance with the instructions in the manuals, it may cause harmful interference with radio communications.

Trimod MCS 3,5,7 and 10 are category C2 products according to standard EN62040-2.

In the home environment these devices could cause radio interference; in this case appropriate countermeasures must be taken.

All other Trimod MCS models are category C3 products according to standard EN62040-2.

They can therefore be used in commercial and industrial environments; nevertheless restrictions or adequate countermeasures might be necessary to avoid radio interference.

**CAUTION**

- The equipment must be maintained and used according to the instructions written in the manuals
- The departmental manager must instruct the operating and maintenance personnel on the safe use and maintenance of the equipment.
- Only specifically-trained, highly skilled personnel are allowed access to the equipment order to perform maintenance. While the maintenance operation is being carried out, signs saying "Maintenance work in progress" must be affixed in the department in such a way that they can be easily seen from each and any access area.
- Any intervention on the equipment must be done only after it has been disconnected from the power supply network by means of a switch disconnecter and must be locked with an appropriate padlock.
- The EPS must not be turned on if liquid is leaking from the batteries.
- Depositing flammable material near the equipment is strictly forbidden. The equipment should always be locked, and only specifically trained personnel are allowed access to them.
- Do not disable any safety, signalling or warning devices and do not ignore any alarms, warning messages or notices, no matter whether they are generated automatically or represented by plates fixed to the equipment.
- Do not run the equipment with fixed protections not installed (panels etc.).
- In case of breaking, buckling or malfunctioning of the equipment or parts of it, repair or replace immediately.
- For no reason can the equipment, the devices and the operation sequence, be modified, disabled or tampered with in any way, without prior consultation with the Manufacturer.
- When replacing fuses, only use ones of the same type.
- The replacement of the batteries is an operation intended to be carried out by a skilled technician.
- Keep a register in which to enter the date, time, type, performer's name and any other useful information about each and any routine- and extraordinary-maintenance operation.
- Do not use oils or chemical products for cleaning because they could scratch, corrode or damage certain parts of the equipment.
- The equipment and workplace must be kept completely clean.
- Upon completion of the maintenance operations, before connecting the power supply, carry out a careful check in order to make sure that no tools and/or material of any kind have been left next to the equipment.

**CAUTION**

The skilled technician must not leave at the disposal of the operator:

- the keys for opening the EPS door;
- the installation and maintenance manual.

2.7 How to proceed in an emergency

The following information are general.

For the specific interventions consult the regulations in force in the country where the equipment is installed.

2.7.1 First-aid procedures

When administering first aid, adhere to the company rules and the usual procedures.

2.7.2 Fire procedures

Do not use water to quench fires but just the extinguishers specifically designed for putting out fires in electrical equipment.

3. Technological description

3.1 Trimod MCS technology

LEGRAND® has developed an innovative project that is the only one of its kind by producing Trimod MCS, the EPS with 3, 5, 7, 10, 15, 20, 30, 40, 60 and 80 kVA power.

The concepts underlying the project are modularity, expandability and redundancy in such a way as to offer maximum reliability and to be the guarantee of considerable savings.

Trimod MCS is EPS designed in accordance with EN 50171 for the preservation of power supply in emergency and security systems. Some of its features are:

- permanent overload capability of 120% in relation to the rated power;
- batteries with rated life expectancy of 10 years;
- battery polarity inversion protection
- protection against complete discharge;
- short circuit protection;
- high current battery charger for full charge time of 12 hours;
- IP20 metal enclosure according to EN 60598-1.

If the mains is available, the EPS output is enabled by default. It is possible to change this setting from the control panel. If the mains input is missing, the output is supplied by the EPS in battery mode.

Trimod MCS is a modular EPS whose base module is single phase and can be programmed to obtain the desired input/output configuration. It is thus possible to manage three phase and single phase voltages on input and output to have a choice of the traditional three phase/three phase, three phase/single phase, single phase/three phase and single phase/single phase. At the same time it is possible to obtain simultaneously single phase and three phase lines on output or two or more single phase lines even with different power.

For every configuration it is possible to have redundancy that is both complete and partial. For example, one normal three phase (or redundant) line can coexist with a redundant single phase (or normal) line on output. The philosophy underlying modularity has also been applied to the batteries that have been supplied in individual drawers that can be extracted and make installation and maintenance easier.

The EPS is controlled by one command board.

The command board (CM) and the power modules (PM) are identified by a unique address inside the system, as shown below:

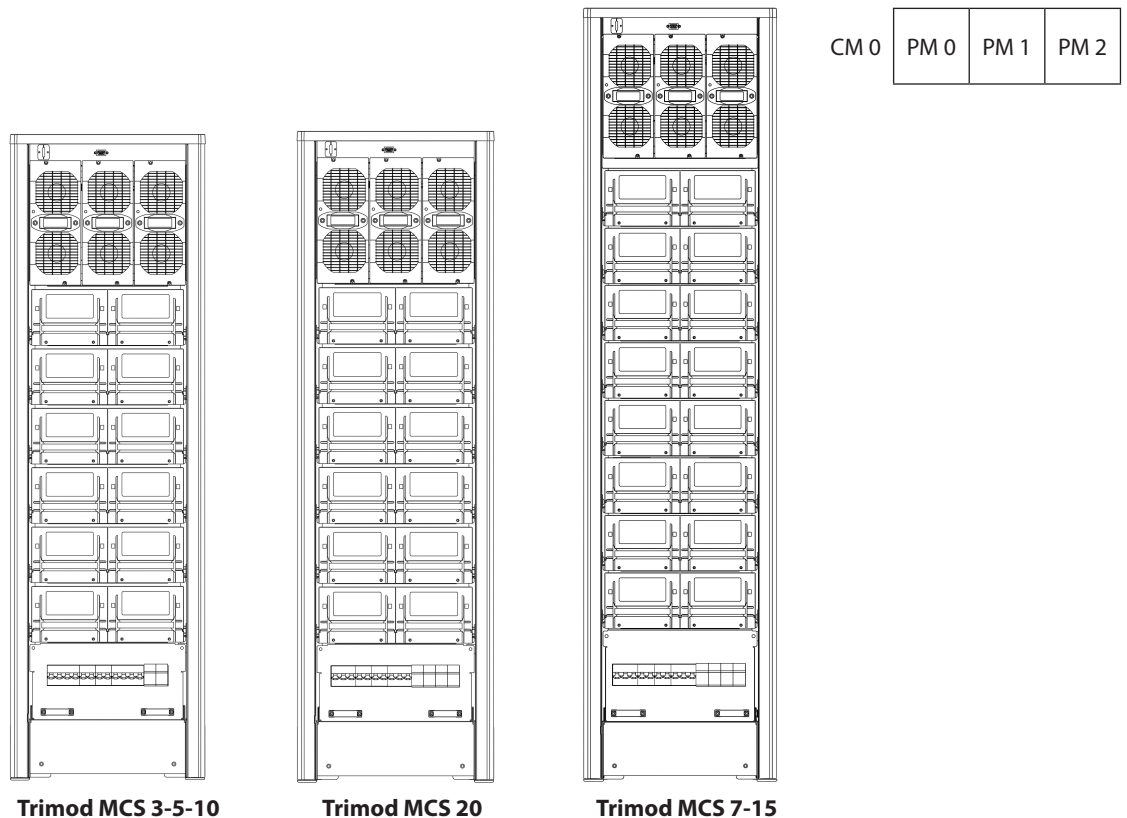

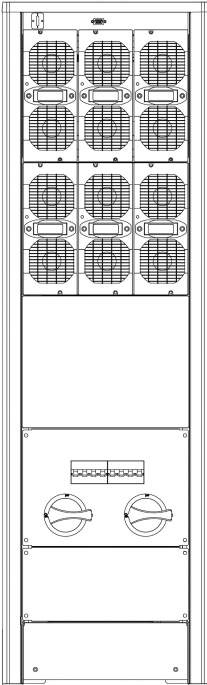

Trimod MCS 30

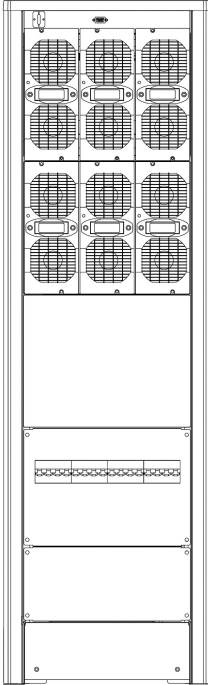

Trimod MCS 40

CM 0	PM 0	PM 1	PM 2
	PM 3	PM 4	PM 5

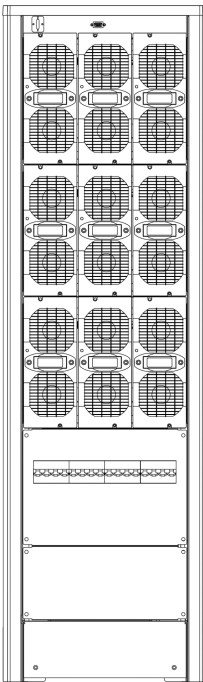

Trimod MCS 60

CM 0	PM 0	PM 1	PM 2
	PM 3	PM 4	PM 5
	PM 6	PM 7	PM 8

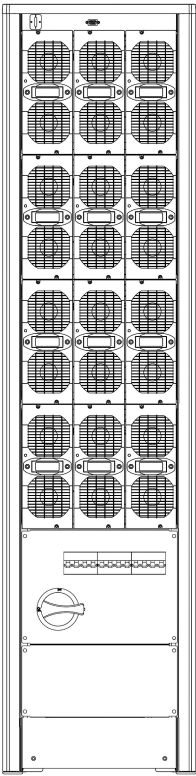

Trimod MCS 80

CM 0	PM 0	PM 1	PM 2
	PM 3	PM 4	PM 5
	PM 6	PM 7	PM 8
	PM 9	PM 10	PM 11

3. Technological description

The command board is connected to a control panel with display from which it is possible to verify the status and setups of the EPS and to a communication interface with RS-232 and SNMP connection, dry contacts and logical contacts. It is possible to access all the EPS functions from the control panel and communicate through any of the interfaces present thereby guaranteeing the redundancy of the peripherals as well. In installations with three separate single phase line on output, it is possible to manage each line independently through the software. For example, it is possible to prioritise the autonomy of one of them during battery operation. A bypass input line separated from that of the mains input makes it possible to supply the bypass with a second power source (the neutral wires of the two lines must be in common).

The technology used in the hardware and the firmware of the EPS represents the current state of the art. A sophisticated microprocessor-type control optimises the performance both on the Booster/PFC side and on the output inverter. The recharge curve of the battery has been designed to get the maximum useful life and have the greatest autonomy possible if the main power goes off. The electronic boards are entirely assembled on LEGRAND automated lines and tested to the highest quality standards. Every device goes through an extended period of operation at full load before being sent to the customer.

3.2 Features

Modular-redundant architecture

The modular-redundant architecture is the best solution for protecting the nerve centres of a company and has the following advantages:

- there is one control of the devices supplied;
- modular expandability;
- module redundancy;
- easy maintenance;
- low running cost;
- compactness.

Efficiency

Trimod MCS concentrates particularly on both the energy absorbed from the mains and the energy provided to the load. They are characterised by high efficiency (up to 96%), PF on input >0,99, THDi <3%.

The advantages of a high efficiency are:

- reduction of the power absorbed from the EPS but not supplied to the load and transmitted to the environment as heat;
- less heat loss transmitted to the environment means reducing the need for ventilation or air conditioning systems in the installation site;
- no power factor correction cost and so no increase in charges;
- no need to increase the size of any generator upstream of the EPS.

Expandability

Most EPS systems on the market are of the non-modular and non-expandable type thus requiring an initial upscaling of the system to make future expansions possible.

The advantages of an expandable system are:

- optimisation of investments for EPS, making them adequate for the current requirements without precluding future expansions and avoiding wastes of energy;
- increase in the efficiency of the system thanks to proper sizing.

Reliability

To obtain a level of redundancy with traditional EPS, it is necessary to put at least two in parallel thereby doubling the power acquired, the space occupied and the electricity consumed. Trimod MCS modular architecture makes it possible to have redundant configurations within a single cabinet.

The advantages are:

- a redundant modularity EPS can be configured as a power redundant N+X system. Even in the case of a fault in a module, the equipment continues to function avoiding any downtime;
- clear indications and a large display make it possible to find the fault more quickly;
- the modular architecture makes it possible to speed up the solution to problems through the simple replacement of the faulty module without interrupting the service;
- high percentage of faults resolved at the first attempt.

Power module

The high-efficiency single phase module, available in three power sizes of 3400 VA (PM4), 5000 VA (PM6) and 6700 VA (PM7) respectively, and is mainly made up of the following functional blocks:

- command and control logic (managed by a microprocessor);
- PFC rectifier/booster;
- inverter;
- battery charger;
- automatic bypass.

In each power module there is a microcontroller that can oversee the main functions of the individual unit, monitor its correct operation and flag up any malfunctions.

The power module is Plug & Play to make the power expansion and any maintenance operation easier. Every module is put in parallel with other identical ones until reaching the power of the EPS.

The modules are independent of each other and can function even if there is a fault in one of them. At the front of the module there is a multicoloured LED with traffic-light code green-yellow-red, making it possible to identify the operating status of the electronic unit quickly.

The power modules are housed on shelves also called “tunnels” that can house three modules.

The block diagram of the power module is the following:

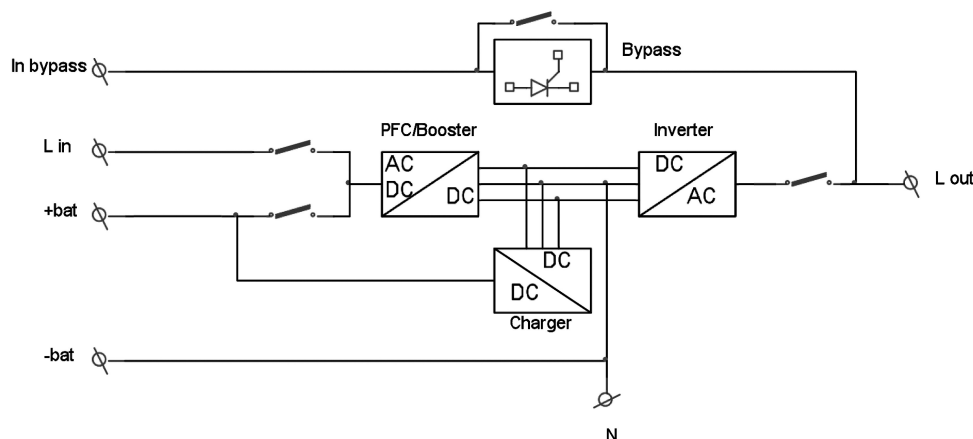

Batteries

The battery modules are designed for easy insertion into the dedicated cabinet and they do not need any operation for their connection. A drawer consists of five 12V-9Ah batteries, connected in series and thanks to the Plug & Play connection it is easy to extract and insert it in the cabinet.

The nominal battery voltage for the Trimod MCS is 240Vdc, therefore a complete branch consists of four battery drawers (for a total of twenty 12Vdc batteries) that form what is called KB (Battery Kit).

In order to ensure the maximum level of safety, the voltage of each drawer is properly isolated into two branches of 24 V and 36 V and it is only restored when the drawer is completely inserted into its housing.

This allows conformity with the standard EN 62040-1 on electrical safety that requires the use of adequate protection and particular care when handling dangerous voltages above 50 Vdc where direct contact is possible.

The battery operation autonomy of the EPS can be increased by adding more battery drawers in multiples of four, using both the seats in the EPS cabinet if available, and the seats in the additional modular battery cabinets.

Digital display and alarm display

Trimod MCS is managed by a microprocessor-type command board (according to the version) and it has a backlit LCD alphanumeric display with twenty characters on four lines.

The display is incorporated in the control panel where there is also a high-brightness operating status indicator with traffic light type green-yellow-red.

Five keys situated near the display enable the user to display the operating data, set the operating parameters, analyse the status of the individual power modules, select the language in which the messages are to be displayed and carry out a guided set of functional tests and procedures.

BCM - Battery Charger Module 3 108 51

The additional battery charger module works in parallel and in sync with the battery chargers in the power modules and it is managed by the same algorithm that governs the recharging cycle. Every additional battery charger module provides up to 15A of charge current that are added to the current of the battery chargers inside the power modules. Every power module can provide up to 2.5A of charge current. This guarantees a reduction of the charge time in installations requiring long autonomies and increases the availability of the UPS after a black out. During operation, the module takes current from the input phase where it is installed.

It is possible to install any quantity of BCMs as long as there is at least one power module and enough empty slots inside the EPS cabinet. All the information regarding the operating status of the BCM is given by the LED on the front of the module and by what is shown on the EPS display.

The module is managed by a microprocessor to optimize performance and reliability. It is recommended to install it together with a battery cabinet with capacity exceeding 60 Ah.

ECO MODE

One functioning mode of Trimod MCS is called “eco mode”. With this mode it is possible to save energy while guaranteeing uninterruptability of the power supply to the load connected. During the functioning in eco mode, the load is powered directly from the electrical mains through the automatic bypass circuit inside the power modules. This means that the output voltage and frequency are the same as the mains. The advantage obtained in the eco mode is a greater electrical efficiency and consequently a reduction in consumption. If the output voltage leaves the window of tolerance (-20% / +15% of the voltage set on the output), the EPS actuates its inverter stage and powers the load with the energy stored in the batteries. The autonomy during the battery operation depends on the configuration of the UPS (nominal power, battery capacity) and on the percentage of load applied. When the mains are back within the tolerance values, the EPS switches automatically back to the eco mode. It is possible to change the operating mode between on-line and eco mode (and viceversa) both with the EPS on and with the UPS off (in this case entering the Service Mode).

3. Technological description

3.3 Models

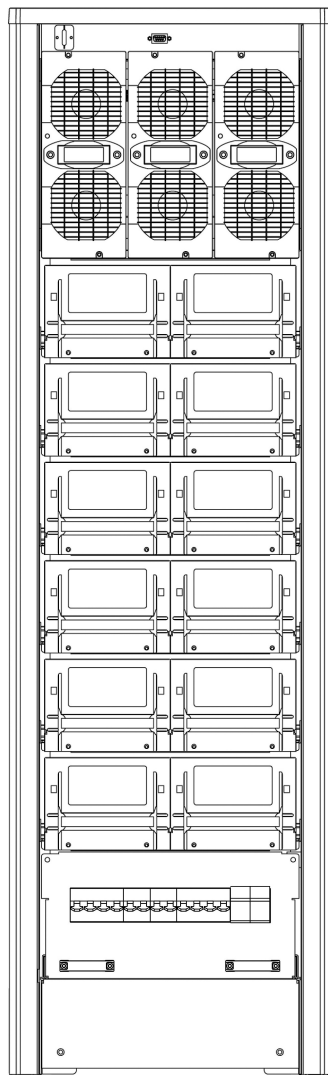

Trimod MCS 3-5-10

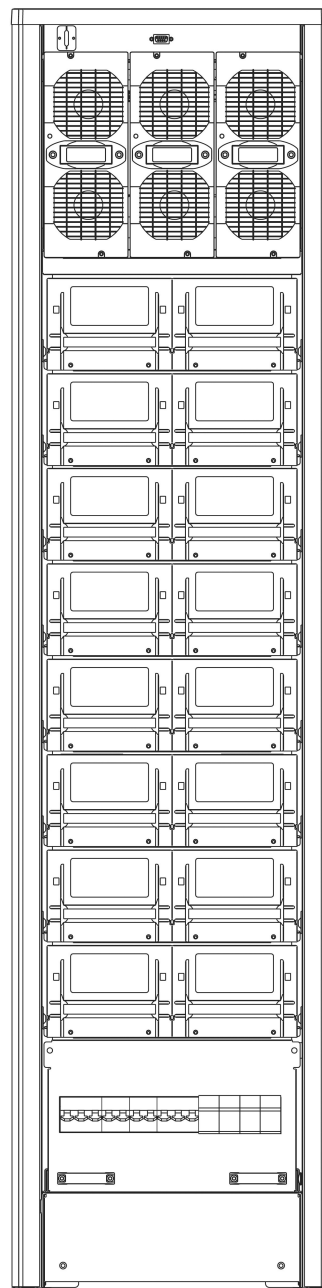

Trimod MCS 7-15

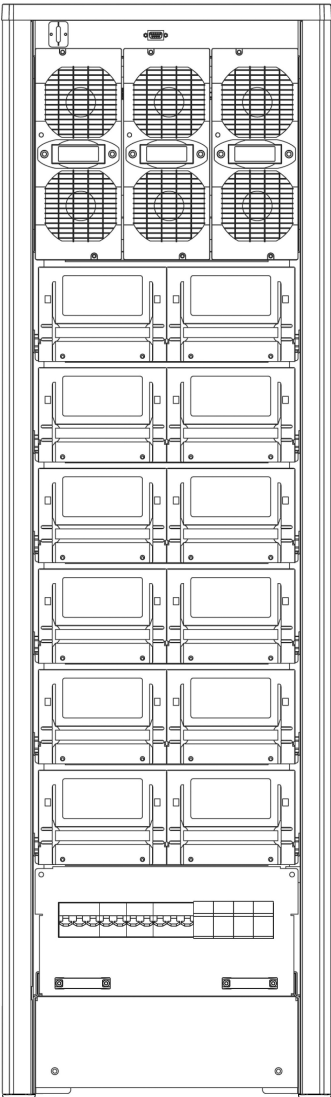

Trimod MCS 20

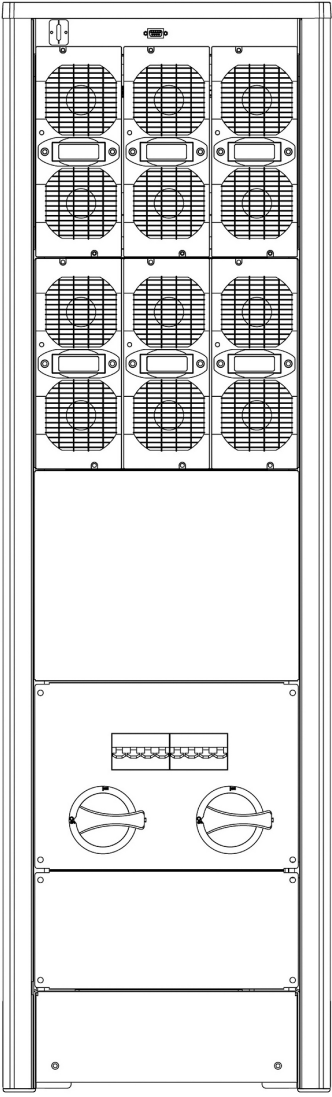

Trimod MCS 30

3. Technological description

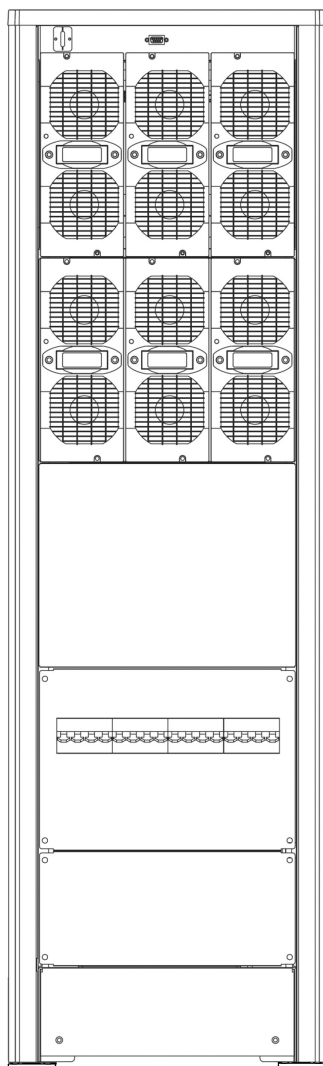

Trimod MCS 40

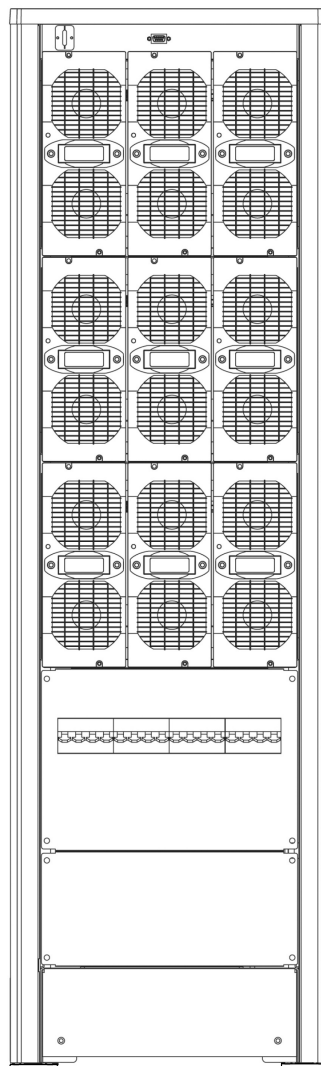

Trimod MCS 60

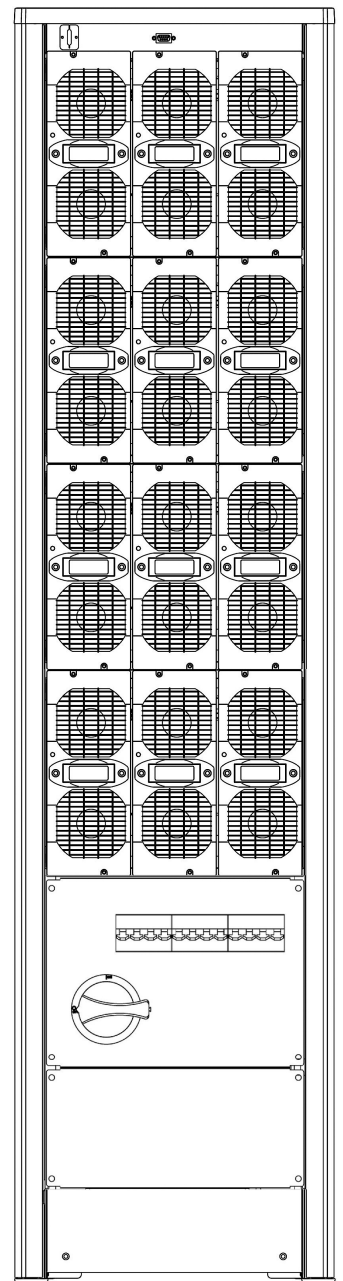

Trimod MCS 80

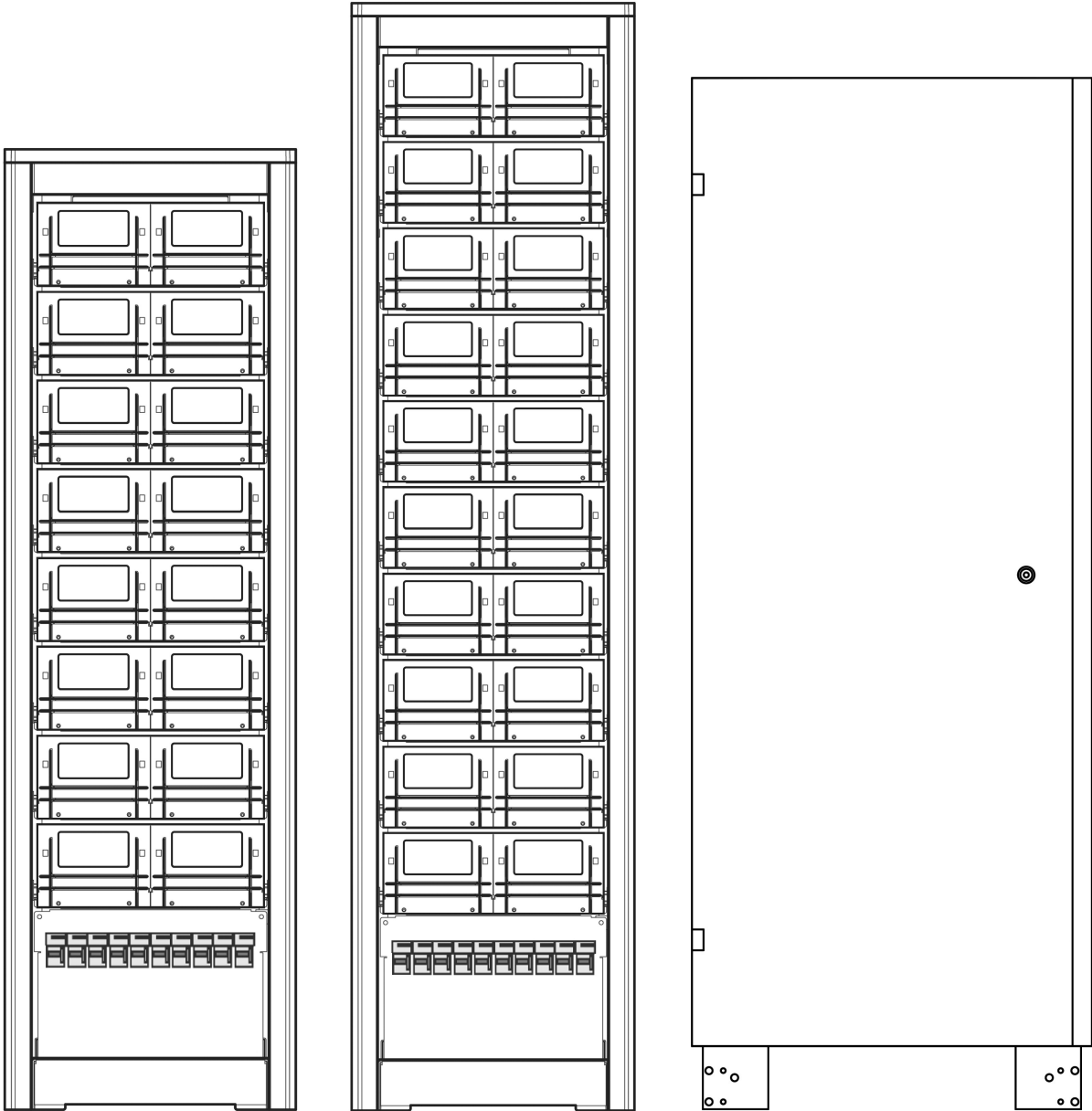

**Trimod MCS MODULAR
BATTERY 4KB**
(16 battery drawers)

**Trimod MCS MODULAR
BATTERY 5KB**
(20 battery drawers)

**Trimod NON-MODULAR
BATTERY 1KB**
(94Ah)

3. Technological description

3.4 Block diagram of interconnections and distributions of the EPS

The following figure shows the block diagram of a Trimod MCS 60 distribution. The layout is similar for all the other models.

The bypass input terminals are represented according to the factory configuration (bypass input line in common).

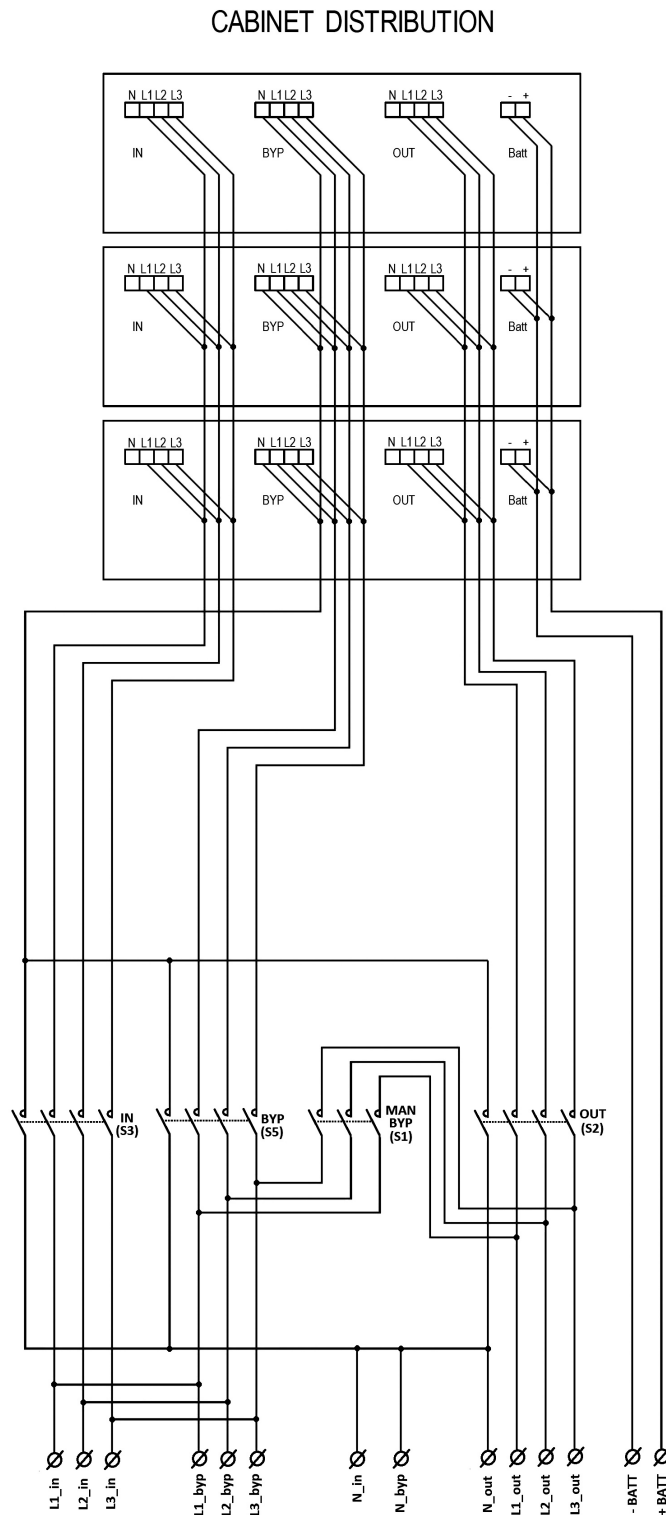

4. Unpacking and positioning

4.1 Visual check

On delivery of the EPS, carefully inspect the packaging and the product for any damage that might have occurred during transport. Check there is no damage to the indicator on the outer label reading "Shock Watch".

If there is possible or ascertained damaged immediately inform:

- the transporter;
- the LEGRAND Technical Support Service.

Check the equipment corresponds with the material indicated in the delivery documentation.

Follow the instructions in Chapter 9 when storing the equipment.

4.1.1 Equipment and supplied accessories check

The equipment and the relative supplied accessories must be in a perfect state of repair.

Check that:

- the shipping data (address of the recipient, no. of packages, order no, etc.) correspond to what is contained in the delivery documentation;
- the technical rating plate data on the label applied to the EPS correspond with the material purchased, described in the delivery documentation;
- the documentation accompanying the equipment includes the installation manual and the user manual.

In case of discrepancy, immediately inform the LEGRAND Technical Support Service before commissioning the equipment.

4.2 Unpacking

To remove the packaging material, comply with the icons on the outside of the box and observe the following procedure:

1. cut the wrapping material and open the plastic packaging safety holds;
2. open the top of the box;
3. remove the upper protection;
4. remove the four protective corners;
5. remove the packaging container pulling it upwards;
6. remove the pallet and the front/rear bracket from the EPS by undoing the four fixing screws present;
7. check the equipment for damage. Immediately inform the shipper and the supplier in the case of apparent damage.

Keep the packaging material for any future shipment of the equipment.

The package can be fully recycled.

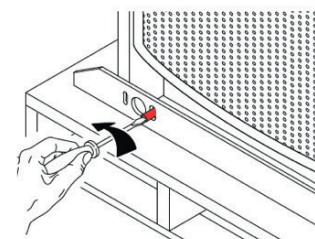

4.3 Check of the content

The content of the supply is subject to thorough checking before the shipment. Nonetheless it is always advisable to check that it is complete and in order on receiving the material.

The following list is general:

- 1 Trimod MCS EPS;
- 1 envelope of accessories containing washers for the contact with the earthing, set of screws for fitting the panels, two eight-pole terminal strips, a serial cable and fuses (the latter are only included in models with internal batteries);
- 1 envelope of accessories containing one or more EC15 connectors according to the model and connecting jumpers for the terminal strip (ONLY for Trimod MCS 10, 15, 20 and 30);
- 1 front closing panel;
- 2 base strips for side closing;
- user manual;
- acceptance report;
- installation and maintenance manual.

Should there be defects and/or missing material, immediately inform the LEGRAND Technical Support Service before commissioning the equipment.



CAUTION

The installation manual must be used and consulted only by SKILLED TECHNICIANS.

INDICATION

In case of purchase of empty cabinets, the power modules and any battery drawers to install must be bought separately.

4. Unpacking and positioning

4.4 Movement



WARNING

Move the EPS very carefully, lifting it as little as possible and avoiding dangerous swings or falls. The equipment must always be handled by trained and instructed personnel equipped with the Personal Protective Equipment illustrated in chapter 2.

The EPS has wheels at the back of the cabinet. Before installations, and while it is still empty, it can be moved by hand by at least two people.

For any lifting, use a forklift or a transpallet with an adequate carrying capacity, placing the forks in the wooden base and making sure they come out the other side by at least twenty centimetres.



WARNING

Do not move the equipment after installation or following the insertion of power modules and any battery drawers.

4.5 Positioning constraints

Minimum recommended distances for the EPS
X=100 mm /
Y=200 mm

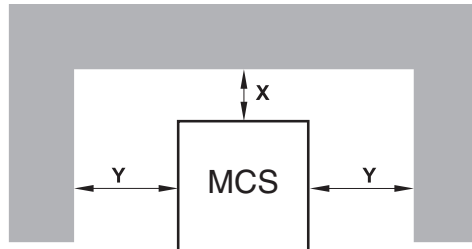

Minimum recommended distances Trimod
MCS UPS + Trimod
MCS BATTERY
X=100 mm /
Y=200 mm

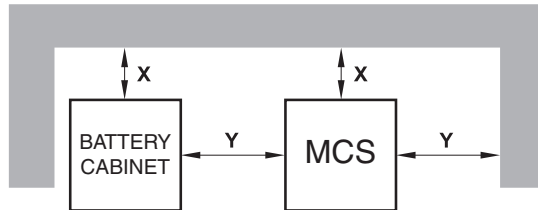

The EPS must be positioned respecting the following conditions:

- temperature and humidity must be within permitted limits;
- fire regulations must be respected;
- the wiring must be simply made;
- front and rear accessibility must be available for assistance or periodic servicing;
- the cooling flow of air must be guaranteed;
- the air conditioning system must be adequately scaled;
- dust or corrosive/explosive gasses must be absent;
- the premises must be free of vibration;
- the rear and side space must be enough to guarantee an adequate circulation of air for cooling;
- the support surface must be scaled in for the carrying capacity necessary to support the equipment.

To safeguard the batteries as well as possible it is necessary to bear in mind that their average lifetime is strongly influenced by the operating room temperature.

Position the equipment in an environment with a temperature range between +20°C (+68°F) and +25°C (+77°F) to guarantee the optimum life of the batteries.

Before proceeding with the installation operations, make sure that there is enough lighting to clearly see every detail. Provide artificial lighting if the natural lighting does not satisfy the requirements cited.

In the case of maintenance operations in places that are not sufficiently well lit, portable lighting systems must be used.

4.6 Final operations

Once the EPS has been properly positioned, fit the two base strips and the front one provided in the accessory kit.

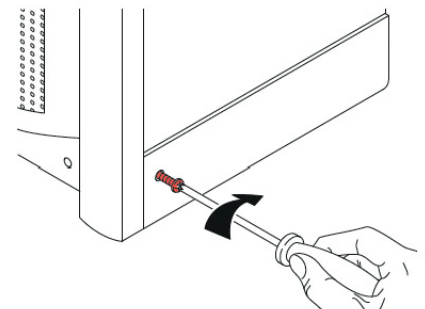

5. Communication devices

Trimod MCS EPS have two RS232 serial ports, one contact interface, one logic level interface on DB15 socket and one SNMP slot. The communication interfaces are found in the rear of the equipment. The RS232 serial maintenance port is inside the EPS door, above the first row of power modules.

CAUTION

- the maximum voltage between any two wires connected to the interface and between any one of these wires and the earth is less than 42Vpk or less than 60Vdc;
- the insulation voltage between any wire connected to the interface and the earth is at least 1500Vac.

5.1 RS232 serial ports

The first of the two RS232 serial ports is called "maintenance RS232" and is found above the first row of power modules, in a part accessible only to a skilled technician with a key to open the door. The RS232 maintenance door is dedicated exclusively to diagnostic functions and to update the equipment firmware.

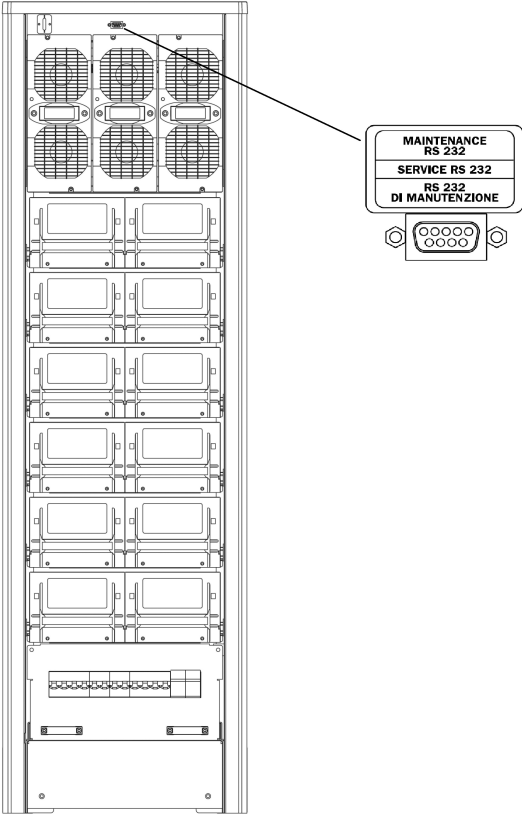

The second serial port called "user interface" is located at the back of the EPS. Via computer, this port allows to access some data relative to the operation of the device as well as control the unmanned shutting down of the operating system.

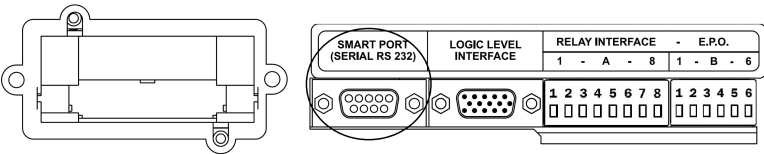

5. Communication devices

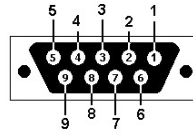

PIN	FUNCTION
2	RX
3	TX
5	GND
1 - 4 - 6	<i>connected together</i>
7 - 8	<i>connected together</i>

5.2 Contact interface

The notifications available through this interface are:

- battery mode operation
- autonomy reserve
- generic alarm
- overload
- EPS in bypass mode
- EPS in operating mode

The contacts of the relay interface are programmed in default mode as normally open (NO) and with specific signalling functions. These settings can be changed by means of the control panel (see section 6.4.2 - path **UPS Setup** → **Dry contacts**).

The contacts are available through 8 and 6 pole connectors.

The electric characteristics of the relay interface are the following:

- $V_{MAX} = 250 \text{ Vac} / 30 \text{ Vdc}$.
- $I_{MAX} = 5 \text{ A}$.

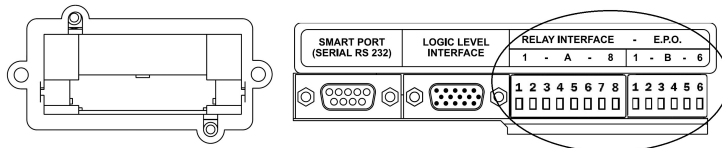

PIN	CONNECTOR A
	FUNCTION
1 - 2	Contact 1 default: battery mode operation
3 - 4	Contact 2 default: autonomy reserve
5 - 6	Contact 3 Default: generic alarm
7 - 8	Contact 4 default: overload

PIN	CONNECTOR B
	FUNCTION
1 - 2	Contact 5 default: EPS in bypass mode
3 - 4	EPO (see paragraph 5.3)
5 - 6	-

5.3 Emergency Power Off (EPO)

The EPS has an external normally closed contact (NC) that can be opened to activate the immediate stop of the equipment.

The EPO terminal is at the back of the EPS on pins 3 and 4 of the 6-pole connector of the relay interface.

For the correct connection of the EPO, the following requirements must be adhered to:

- use a double-insulation cable of up to 10 meters in length;
- check that the switch used is galvanically isolated.

INDICATION

It is not possible to connect the EPO circuits of different EPS in parallel. If necessary, use contacts on the EPO emergency pushbutton isolated from each other.

The electric characteristics of the EPO interface are:

- voltage between terminals 3 and 4 with open circuit: 12Vdc.
- current between terminals 3 and 4 with closed circuit: 5mA.

The figure below shows how the EPO connection must be made:

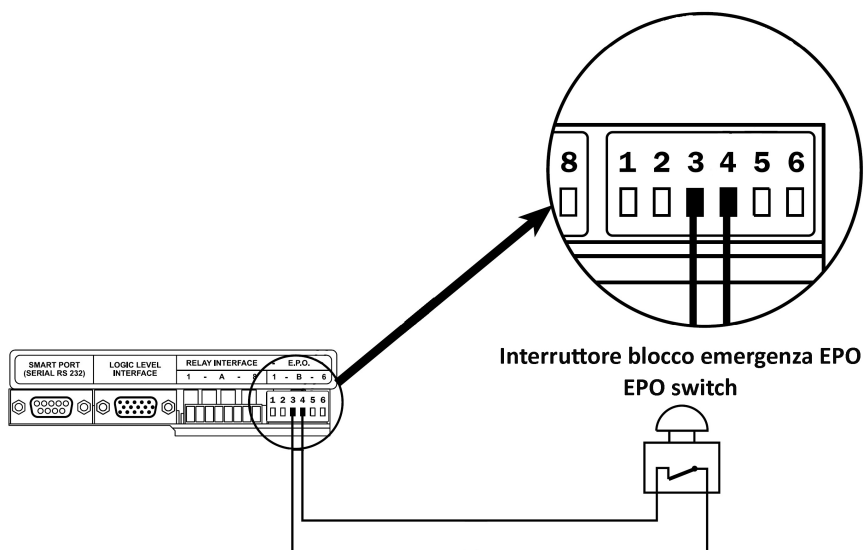

5.4 Logic level interface

The logic level interface is available on connector DB15 at the back of the EPS and makes it possible to connect the equipment in remote control mode with the aim of monitoring its operating status.

The following control signals are available:

- Mains/battery operation
- Autonomy reserve
- EPS fault
- Overload
- EPS in bypass mode
- ON/OFF input

The electric characteristics of the logic level interface are:

- Logical output: $V_{MAX} = 12$ Vdc, impedance on output: 2.2 k Ω in series
- Power supply: 12 Vdc, $I_{MAX} = 700$ mA, not regulated.
- Open collector outputs: 30 Vdc, $I_{MAX} = 100$ mA.

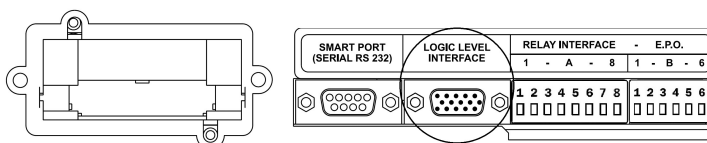

5. Communication devices

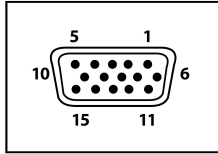

PIN	FUNCTION
1	GND
2	Mains / Battery (output, active high)
3	Autonomy reserve (output, active high)
4	Power supply
6	Test IN (if the output is disabled in normal mode, it is possible to enable it in presence of the mains by connecting the pin to the GND)
7	Overload (open collector, active low)
12	EPS in battery mode (open collector, active low)
13	EPS in bypass mode (open collector, active low)
14	Autonomy reserve (open collector, active low)
15	Alarm (open collector, active low)
5 - 8 - 9 - 10 - 11	<i>do not connect</i>

Two examples of how the open collector outputs and the TEST IN pin can be used are given below:

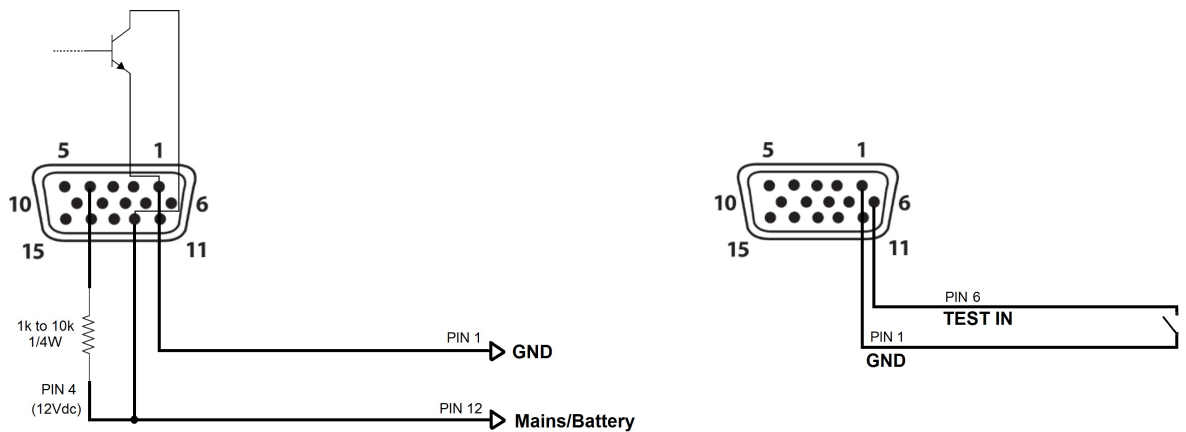

5.5 Network card (SNMP) slot

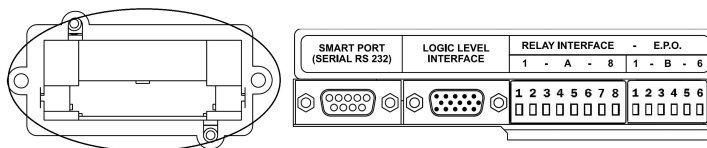

At the back of the EPS there is a slot for the SNMP card (optional).

The current taken from the SNMP slot for the operation of the network card must be in total less than 700mA.

6. Control panel

6.1 Description



WARNING

The control panel allows to access some configuration pages of the EPS menu. Only a skilled technician (paragraph 2.2.1) is authorized to modify the configuration set during the installation. Wrong settings could lead to injury or material damage to the equipment and the things around it.

The control panel is in the front part of the equipment and consists of an LCD display with 4 x 20 character rows, a backlit multicolour status indicator and a five keys keyboard.

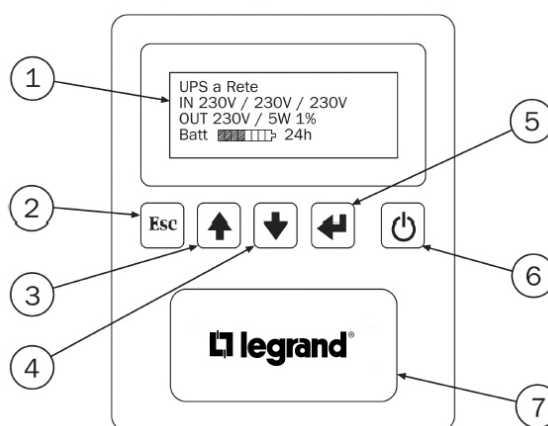

LEGEND

1 - 4 line x 20 characters LCD display

2 - ESCAPE key

Main functions:

- exit a function without changing it;
- passage from a lower to a higher menu level;
- exit the main menu and return to the status display;
- silence of the buzzer.

3 - ARROW UP key

Main functions:

- selection of the previous function;
- increase of a value within a function;
- selection of a new item within a function (e.g. from DISABLED to ENABLED);
- scroll a menu with more than four lines
- change of the page of the main screen.

4 - ARROW DOWN key

Main functions:

- selection of the following function;
- decrease of a value within a function;
- selection of a new item within a function (e.g. from DISABLED to ENABLED);
- scroll a menu with more than four lines
- change of the page of the main screen.

5 - ENTER key

Main functions:

- confirmation of a value;
- access a menu item;
- passage from a higher to a lower menu level;
- it allows access to the Service Mode.

6 - ON/OFF key

Main functions:

- to turn the EPS on and off;
- to shut down the output phases individually (only with the EPS set with 3 output independent phases).

7 - multicolour backlit status indicator

6. Control panel

6.2 Service Mode

This is the operating mode necessary to make the setup during the installation and to manage the software update of the command board and power modules.

To access this mode, press the ENTER key with the the EPS off until the display shows the text "Service Mode..." At the end of the start-up procedure, press the ENTER key to access the navigation menu.

It is possible to choose one of the following languages for the text displayed: Italian, English, German, French, Russian, Spanish, Polish and Portuguese. Follow the path: **UPS Setup** → **Operator Panel** → **Language** and press the ENTER key to confirm the choice.

Press the ON/OFF key to exit. Alternatively, the EPS turns off automatically after 20 minutes without receiving manual or serial commands.

6.3 Main screen

The main screen is shown on the display during EPS operation.

Using the ARROW UP and ARROW DOWN keys it is possible to scroll through the different pages. Every page gives several information about the status of the equipment.

The pictures of the different pages of the main screen are shown below:

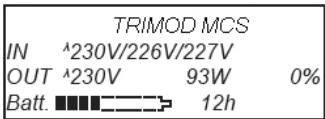
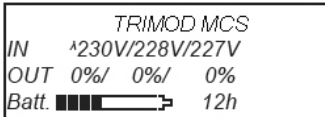
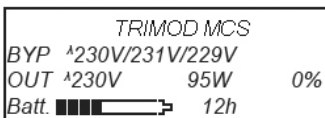
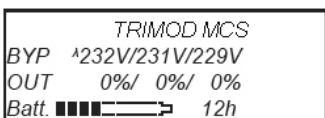
MAIN PAGE	DATA DISPLAYED
<p>1 input - output - battery</p> 	<p>1st line: Operating status of the EPS. If the text alternates "TRIMOD MCS" and "EPS in stand-by", the output is disabled</p> <p>2nd line: Input voltages</p> <p>3rd line: Voltage set on output, active power absorbed by the load and total percentage of the load applied.</p> <p>4th line: Bar showing the battery residual capacity and the actual operation time in case of a power failure.</p>
<p>2 input - percentage output - battery</p> 	<p>1st line: Operating status of the EPS. If the text alternates "TRIMOD MCS" and "EPS in stand-by", the output is disabled</p> <p>2nd line: Input voltages</p> <p>3rd line: Percentage of the load on the output phases</p> <p>4th line: Bar showing the battery residual capacity and the actual operation time in case of a power failure.</p>
<p>3 bypass - output - battery</p> 	<p>1st line: Operating status of the EPS. If the text alternates "TRIMOD MCS" and "EPS in stand-by", the output is disabled</p> <p>2nd line: Bypass voltages</p> <p>3rd line: Voltage set on output, active power absorbed by the load and total percentage of the load applied.</p> <p>4th line: Bar showing the battery residual capacity and the actual operation time in case of a power failure.</p>
<p>4 bypass - percentage output - battery</p> 	<p>1st line: Operating status of the EPS. If the text alternates "TRIMOD MCS" and "EPS in stand-by", the output is disabled</p> <p>2nd line: Bypass voltages</p> <p>3rd line: Percentage of the load on the output phases</p> <p>4th line: Bar showing the battery residual capacity and the actual operation time in case of a power failure.</p>

MAIN PAGE	DATA DISPLAYED																
<p>5 load availability on output</p> <table border="1" style="width: 100%; border-collapse: collapse;"> <tr> <td colspan="4" style="text-align: center;"><i>TRIMOD MCS</i></td> </tr> <tr> <td>L1o</td> <td>0.4/</td> <td>40kVA</td> <td>1%</td> </tr> <tr> <td>L2o</td> <td>0.5/</td> <td>40kVA</td> <td>1%</td> </tr> <tr> <td>L3o</td> <td>0.5/</td> <td>40kVA</td> <td>1%</td> </tr> </table>	<i>TRIMOD MCS</i>				L1o	0.4/	40kVA	1%	L2o	0.5/	40kVA	1%	L3o	0.5/	40kVA	1%	<p>1st line: Operating status of the EPS. If the text alternates "TRIMOD MCS" and "EPS in stand-by", the output is disabled</p> <p>2nd line: Phase L1 - power in kVA or in W compared with the rated power or current compared with the rated one and relative percentage</p> <p>3rd line: Phase L2 - power in kVA or in W compared with the rated power or current compared with the rated one and relative percentage</p> <p>4th line: Phase L3 - power in kVA or in W compared with the rated power or current compared with the rated one and relative percentage</p>
<i>TRIMOD MCS</i>																	
L1o	0.4/	40kVA	1%														
L2o	0.5/	40kVA	1%														
L3o	0.5/	40kVA	1%														
<p>6 measurements on output</p> <table border="1" style="width: 100%; border-collapse: collapse;"> <tr> <td colspan="3" style="text-align: center;"><i>TRIMOD MCS</i></td> </tr> <tr> <td>L1o231V</td> <td>1.7A</td> <td>27W</td> </tr> <tr> <td>L2o229V</td> <td>1.6A</td> <td>31W</td> </tr> <tr> <td>L3o231V</td> <td>1.9A</td> <td>29W</td> </tr> </table>	<i>TRIMOD MCS</i>			L1o231V	1.7A	27W	L2o229V	1.6A	31W	L3o231V	1.9A	29W	<p>1st line: Operating status of the EPS. If the text alternates "TRIMOD MCS" and "EPS in stand-by", the output is disabled</p> <p>2nd line: Output L1 phase: Voltage, current and active power</p> <p>3rd line: Output L2 phase: Voltage, current and active power</p> <p>4th line: Output L3 phase: Voltage, current and active power</p>				
<i>TRIMOD MCS</i>																	
L1o231V	1.7A	27W															
L2o229V	1.6A	31W															
L3o231V	1.9A	29W															
<p>7 output line voltages</p> <table border="1" style="width: 100%; border-collapse: collapse;"> <tr> <td colspan="2" style="text-align: center;"><i>TRIMOD MCS</i></td> </tr> <tr> <td>L1o-L2o Δ</td> <td>400V</td> </tr> <tr> <td>L2o-L3o Δ</td> <td>399V</td> </tr> <tr> <td>L3o-L1o Δ</td> <td>396V</td> </tr> </table>	<i>TRIMOD MCS</i>		L1o-L2o Δ	400V	L2o-L3o Δ	399V	L3o-L1o Δ	396V	<p>1st line: Operating status of the EPS. If the text alternates "TRIMOD MCS" and "EPS in stand-by", the output is disabled</p> <p>2nd line: line voltage between L1 and L2 on output</p> <p>3rd line: line voltage between L2 and L3 on output</p> <p>4th line: line voltage between L3 and L1 on output</p>								
<i>TRIMOD MCS</i>																	
L1o-L2o Δ	400V																
L2o-L3o Δ	399V																
L3o-L1o Δ	396V																
<p>8 measurement on input</p> <table border="1" style="width: 100%; border-collapse: collapse;"> <tr> <td colspan="3" style="text-align: center;"><i>TRIMOD MCS</i></td> </tr> <tr> <td>L1i229V</td> <td>3.4A</td> <td>408W</td> </tr> <tr> <td>L2i228V</td> <td>2.9A</td> <td>162W</td> </tr> <tr> <td>L3i230V</td> <td>2.6A</td> <td>228W</td> </tr> </table>	<i>TRIMOD MCS</i>			L1i229V	3.4A	408W	L2i228V	2.9A	162W	L3i230V	2.6A	228W	<p>1st line: Operating status of the EPS. If the text alternates "TRIMOD MCS" and "EPS in stand-by", the output is disabled</p> <p>2nd line: Input L1 phase: Voltage, current and active power</p> <p>3rd line: Input L2 phase: Voltage, current and active power</p> <p>4th line: Input L3 phase: Voltage, current and active power</p>				
<i>TRIMOD MCS</i>																	
L1i229V	3.4A	408W															
L2i228V	2.9A	162W															
L3i230V	2.6A	228W															
<p>9 bypass line voltages</p> <table border="1" style="width: 100%; border-collapse: collapse;"> <tr> <td colspan="2" style="text-align: center;"><i>TRIMOD MCS</i></td> </tr> <tr> <td>L1b-L2b Δ</td> <td>401V</td> </tr> <tr> <td>L2b-L3b Δ</td> <td>402V</td> </tr> <tr> <td>L3b-L1b Δ</td> <td>400V</td> </tr> </table>	<i>TRIMOD MCS</i>		L1b-L2b Δ	401V	L2b-L3b Δ	402V	L3b-L1b Δ	400V	<p>1st line: Operating status of the EPS. If the text alternates "TRIMOD MCS" and "EPS in stand-by", the output is disabled</p> <p>2nd line: Line voltage between L1 and L2 of bypass line</p> <p>3rd line: Line voltage between L2 and L3 of bypass line</p> <p>4th line: Line voltage between L3 and L1 of bypass line</p>								
<i>TRIMOD MCS</i>																	
L1b-L2b Δ	401V																
L2b-L3b Δ	402V																
L3b-L1b Δ	400V																
<p>10 battery status</p> <table border="1" style="width: 100%; border-collapse: collapse;"> <tr> <td colspan="4" style="text-align: center;"><i>TRIMOD MCS</i></td> </tr> <tr> <td>Batt.</td> <td>^A288V</td> <td></td> <td>-0,3A</td> </tr> <tr> <td>C 50%</td> <td>R 12h</td> <td>T 24h</td> <td></td> </tr> <tr> <td>Charging</td> <td colspan="3" style="text-align: center;">-maint</td> </tr> </table>	<i>TRIMOD MCS</i>				Batt.	^A 288V		-0,3A	C 50%	R 12h	T 24h		Charging	-maint			<p>1st line: Operating status of the EPS. If the text alternates "TRIMOD MCS" and "EPS in stand-by", the output is disabled</p> <p>2nd line: voltage, charging current (negative value when charging in progress, positive value when the batteries are powering the equipment)</p> <p>3rd line: battery capacity percentage compared with the nominal percentage, time remaining, total autonomy time</p> <p>4th line: battery status:</p> <ul style="list-style-type: none"> - Battery Stand-by - Discharging - Reserve autonomy - End autonomy - Charging - ph1 - battery recharging status (current limitation) - Charging - ph2 - battery recharging status (voltage limitation) - Charging - maint: Battery recharging in maintenance mode - Charging - float.: Battery charging in floating mode - Testing batteries: Battery test in progress - Equaliz. batteries: Battery equalizing in progress - BATTERY FAULT: battery voltage less than 100 V - MaxTime on Battery: End of the maximum set time for battery mode operation
<i>TRIMOD MCS</i>																	
Batt.	^A 288V		-0,3A														
C 50%	R 12h	T 24h															
Charging	-maint																

6. Control panel

6.4 Main menu and submenu

Press the ENTER key on the main screen of the display to access the main menu.

The main menu has the following items:

- UPS Status: it allows to check the EPS status in real time;
- UPS Setup: it allows to configure all the EPS functions;
- Power Modules: it allows to analyze the status of the individual power modules in real time;
- Events: it allows to display the events memorized in the EPS history;
- Tools: it allows to carry out a series of functional tests on the EPS;
- Log Out: it allows to end the password-protected session.

Press the ENTER key to access the relative submenus.

The following table sums up all the menu and submenu pages:

UPS Status (par. 6.4.1)	UPS Setup (par. 6.4.2)	Power Modules (par. 6.4.3)	Events (par. 6.4.4)	Tools (par. 6.4.5)	Log Out (o) (par. 6.4.6)
UPS Info	Options	PM Status	Log View	Battery	-
UPS Cfg	Output	Diagnostics (*)		Signalling Test (*)	
Measures	Input	PM SW update (*)		LCD Display Test (*)	
Alarms	Bypass			Assistance	
History Data	Batteries			CM errors recovery	
	Operator Panel				
	Clock Setup				
	Dry contacts				

(*) Only available in "Service Mode"

(o) Available in password-protected session

The equipment has a menu and relative submenu tree structure, the functions of which are explained in the following paragraphs.

On the right side of the display, an arrow appears turned downwards or upwards when there are further items to display. Press the ARROW UP and ARROW DOWN keys to display them.

6.4.1 UPS Status

UPS Info	Model	Equipment model (TRIMOD MCS)
	SYNC. address	Synchronisation address of the command board
	Number of CM	Number of command boards recognised
	Max VA	Maximum apparent power [kVA]
	Maw W	Maximum active power [kW]
	Max Ichg	Maximum current available to charge the batteries [A]
	SW Ver.	Firmware version of the command board
	PM SW Ver.	Firmware version of the power modules
	Boot Ver.	Bootloader version in the command board
	S/N	EPS serial number

UPS Cfg	OUT	Single Phase/ Three Phases 120° / Three Phases indep.
	IN	Single Phase / Three Phases / Inv.3 phases / Undefined (_ _)
	BYP	Single Phase / Three Phases / Inv.3 phases / Undefined (_ _)
	X/Y -- X/Y - X/Y	X Power modules for each phase managed by the command board Y Power modules for each phase managed by the EPS
	Number BCM	Number of battery charger module recognised
	Installed KB	Number of KB installed
	Batt. Cap.	Capacity of the batteries installed [Ah]
	Batt.N per KB	Number of batteries in series available in one KB

Measures	Output X	Power	Output active power on phase X [W]
		Appar. Power	Output apparent power on phase X [VA]
		Vrms	Output effective voltage on phase X [V rms]
		Vrms ph-ph	Effective line voltage among the output phases [V rms]
		Irms	Output effective current on phase X [A rms]
		Peak Current	Output peak current on phase X [A]
		Frequency	Pure sine output voltage frequency on phase X [Hz]
		I Crest factor	Crest factor for phase X
		Power fact.	Power factor of the load connected to the EPS on phase X
		Maw W	Maximum active power available on phase X [W]
		Power	Active power on phase X, expressed as a percentage in relation to the maximum active power available on phase X [%]
		Max VA	Maximum apparent power available by the EPS on phase X [VA]
		Appar. Power	Apparent power on phase X, expressed as a percentage in relation to the maximum apparent power available by the EPS on phase X [%]

INDICATION

To change the value of X and therefore vary the phase from which the data is read, press the ENTER key after entering the submenu.

6. Control panel

Measures	Input X	Power	Absorbed input active power on phase X [W]
		Appar. Power	Absorbed input apparent power on phase X [VA]
		Vrms	Effective input voltage of phase X [V rms]
		Vrms bypass	Effective input voltage of phase X of bypass line [V rms]
		Vrms ph-ph	Effective line voltage among the input phases [V rms]
		Irms	Absorbed effective input current on phase X [A rms]
		Peak Current	Input peak current on phase X [A]
		Frequency	Pure sine input voltage frequency on phase X [Hz]
		I Crest Factor	Crest factor for phase X
		Power Fact.	Power factor of the load connected to the UPS on phase X

INDICATION

To change the value of X and therefore vary the phase from which the data is read, press the ENTER key after entering the submenu.

Measures	Batteries	Voltage	Battery voltage [V]
		Current	Current supplied by the batteries (negative if the EPS is charging the batteries) [A]
		Residual Cap.	Battery charge status, expressed as percentage [0-100%]
		(Status)	Battery charge operating status: - Battery Stand-by - Discharging - Reserve autonomy - End autonomy - Charging - ph1 - Charging - ph2 - Charging - maint. - Testing batteries - Equaliz. batteries - BATTERY FAULT - MaxTime on Battery
		Total Auton.	Total autonomy the EPS would have with batteries 100% charged
		Resid.Auton.	Residual autonomy of the EPS
		V Res.Th.	Threshold voltage of the string of batteries for autonomy end [V]
		Disch.Count	Total number of complete battery discharges
		Usage	Total number of hours in which the EPS has functioned in battery mode [h]
		Cal.	Day and time of the last calibration. The text "Factory" is displayed if no calibration has yet been made.
		Calibr.count	Total number of calibrations made

Measures	Misc.	Int.Temp	Internal temperature [°C]
		Pos.H.V.Bus	Voltage on positive DC BUS [V]
		Neg.H.V.Bus	Voltage on negative DC BUS [V]

Alarms	Alarm Log. See chapter 7.
---------------	---------------------------

INDICATION

To scroll through the list of alarms, press the ARROW UP and ARROW DOWN keys.

History Data	UPS RunTime	Total runtime
	OnBatteryTime	Total runtime on battery mode
	This batt.	Total runtime with the batteries currently installed
	CHG Runtime	Total battery charger runtime
	DrainedOut N.	Total number of complete battery discharges
	Booster Int.	Total number of booster interventions
	BypassInterv.	Total number of bypass interventions
	Batt.calibr.	Total number of battery calibrations
	Chg.cycle N.	Total number of battery charge cycles
	Batt.equal.N.	Total number of battery equalization cycles
	Replace batt.N.	Total number of times the batteries have been replaced
	Load>80% N	Total number of times the load has exceeded 80% of the rated load
	Load>80% T	Total time the load has exceeded 80% of the rated load
	Load>100% N	Total number of times the load has exceeded 100% of the rated load
	Load>100% T	Total time the load has exceeded 100% of the rated load without the overload being signalled

6.4.2 UPS Setup

Options	Startup on Battery	If enabled, it allows the EPS to be started up with no mains supply		
	Auto Restart	If enabled, automatic restarts are permitted		
	Output options (*)	DISABLED	During normal functioning, the output is not powered.	
		ENABLED	During normal functioning, the output is powered.	

(*) Only available in the "Service Mode"

6. Control panel

Output	Voltage	This sets the output voltage value [V]	
	Frequency	Nominal value (*)	This makes it possible to set the output frequency value (50 Hz or 60 Hz) independently of the input frequency.
		Auto selection	If enabled, the EPS detects the frequency of the input voltage and synchronises the output to the same value. If disabled, the EPS uses the "Nominal Value" setting.
	Inverter (*)	This sets the output configuration and the applied load: - Single Phase: a unique single phase output - Three Phases 120°: three phase output suitable for the supply of three phase loads (e.g. a motor) - Three Phases indep.: three single phase output lines that are independent of each other	
	Phases in startup (**)	L1 phase	This makes it possible to program the start-up status for each output: - Always ON: phase always on during start-up - Always OFF: phase always off during start-up - Last state: phase restored to the status prior to the shutdown
L2 phase			
L3 phase			

(*) Available in the "Service Mode" only

(**) Available with the inverter set up as three independent phases only



WARNING

Only a skilled technician is authorized to modify the settings on the **Output** menu

Input	PLL enable	If enabled, the EPS synchronises the output pure sine with that of the input. If disabled, the output voltage is not synchronised with the input and it is indicated with the status light (green) flashing.
	PLL Range	This makes it possible to select the frequency range in which the EPS synchronises the output voltage with the input: - NORMAL: synchronization for frequency variations of $\pm 2\%$ of the nominal value - EXTENDED: synchronization for frequency variations of $\pm 14\%$ of the nominal value - CUSTOM: this can be set by the user (see the next menu item)
	Custom PLL Range °	This makes it possible to set the customised frequency interval in which the EPS synchronises the output voltage with the input. The value can be selected from a minimum of 0.5 Hz to a maximum of 7.0 Hz with 0.1 Hz step
	Input Dip Enable	This allows the input Dip function to be enabled/disabled

° Available with PLL range set in CUSTOMISED mode

INDICATION

The PLL function ensures that the output frequency is synchronised with that of the input, guaranteeing that passage through zero (zero-crossing) occurs at the same moment. The input-output synchronisation is guaranteed even in case of bypass intervention (e.g. because of overload).

INDICATION

By disabling the PLL function, the automatic bypass function is deactivated as well. The equipment turns off in case of an extended overload.



WARNING

Only a skilled technician is authorized to modify the settings on the **Input** menu

Bypass	Bypass enable	If enabled, the EPS manages the bypass intervention automatically. If disabled, the EPS never switches to bypass mode so in the case of an extended overload or in the case of failure and absence of redundancy, it turns off.
	Forced Mode	If enabled, the EPS activates the bypass permanently
	DIP speed	It allows to vary the switching circuit sensitivity: - SLOW: indicated for loads that are not sensitive to voltage fluctuations and that cause current peaks - STANDARD: normal mode - FAST: for all loads that are highly sensitive to voltage fluctuations
	Off-Line Mode	If enabled, the EPS operates in eco mode. During the operation, the load is powered directly by the automatic bypass circuit. If there is a power failure or the voltage input tolerance is exceeded, the EPS activates the inverter thereby powering the load through the batteries.
	Startup on Bypass	If enabled, on mains start-up the initial powering of the load occurs via bypass. If disabled, the inrush current is managed by the inverter as in a battery start-up.

**WARNING**

Only a skilled technician is authorized to modify the settings on the **Bypass** menu

Batteries	Threshold Values	Reserve Time	This sets the start time of the battery autonomy warning [min]
		MaxTime on Battery	This sets the maximum operating time in battery mode. Once this time has elapsed, the EPS turns off. Set at OFF to disable the function
	Charger	Standby Charge	If enabled, it activates the battery charge with the EPS off
	Auto Restart	Restart Enable	This enables or disables the restart of the EPS when the mains returns after the total discharge of the batteries
		Min. Autonomy	This sets the percentage charge value of the batteries to be reached with the standby charge function in order to restart automatically the EPS after a total battery discharge.
	Total KB	This sets the total number of KB installed. The parameter is necessary for the EPS to provide correct values for the autonomy based on the load applied and for a correct battery charge.	
Capacity (*)	This sets the capacity value of the batteries in the EPS [Ah].		

(*) Available in the "Service Mode" only

**WARNING**

Only a skilled technician is authorized to modify the settings on the **Batteries** menu

6. Control panel

Operator Panel	Language	This sets the language on the display
	Buzzer	This enables/disables all the sound signals
	Keyboard Beep	This enables/disables the key pressure sound
	Locked turn off (*)	If enabled, the password is required to shutdown the equipment
	Display Backlight	This sets the backlighting of the display: - FIXED: always lit - TIMED: the backlighting turns off after one minute of keyboard inactivity - DISABLED: always off
	Display Contrast	This sets the display contrast
	Password Change	This sets a password that blocks access to the settings
	Password level	It indicates the level of the password (the default value is USER)

(*) Only available with the chosen password.

Clock Setup	DD/MM/YY – HH:mm:SS	This sets the date/time of the EPS. By pressing the ENTER key, the value to modify is selected. By pressing the ARROW UP/DOWN keys, the selected value is increased or decreased. DD: day MM: month YY: year HH: hour mm: minutes SS: seconds
--------------------	---------------------	---

Dry contacts	Contact 1	Function	This allows the signal to be associated with the contact: - Mains/Battery - Runtime autonomy - Alarm - Overload - Bypass - UPS is working
		Setup	This allows to set the type of contact: - NORMALLY CLOSED - NORMALLY OPEN
	Contact 2	Function	(see contact 1)
		Setup	
	Contact 3	Function	(see contact 1)
		Setup	
	Contact 4	Function	(see contact 1)
		Setup	
	Contact 5	Function	(see contact 1)
		Setup	
All	This allows to set for all the contacts: - NORMALLY CLOSED - NORMALLY OPEN		

6.4.3 Power Modules

PM Status	PM Info X	Mod.	Model of power module X	
		SW Ver.	Version of the firmware inside power module X	
		HW Ver.	Hardware version of power module X	
		S/N	Serial number of power module X	
		Max VA	Maximum apparent power supplied by power module X [VA]	
		Maw W	Maximum available active power supplied by power module X [W]	
		Max Ichg	Maximum current available from the battery charger of power module X [A]	
	PM Measures	Input X	Power	Active power absorbed by the mains by power module X [W]
			Appar.Power	Apparent power absorbed by the mains by power module X [VA]
			Vrms	Effective input voltage to the power module X [V rms]
			Vrms bypass	Effective input voltage to the power module X of the bypass line [V rms]
			Vrms ph-ph	Input line voltage to the power module X [V rms]
			Irms	Effective current absorbed by the mains supplied by power module X [A rms]
			Peak Current	Peak current of the power module X [A]
			Frequency	Pure sine input frequency voltage of power module X for the bypass line [Hz]
			I Crest factor	Crest factor applied by power module X to the mains
			Power fact.	Power factor applied by power module X to the mains
		Output X	Power	Active power supplied by power module X [W]
			Appar.Power	Output apparent power supplied by power module X [VA]
			Vrms	Effective output voltage of power module X [V rms]
			Vrms ph-ph	Effective output line voltage of power module X [V rms]
			Irms	Effective output current supplied by power module X [A rms]
			Peak Current	Output peak current of power module X [A]
			Frequency	Pure sine output voltage frequency of power module X [Hz]
			I Crest factor	Crest factor of the output current of power module X
			Power fact.	Output power factor for power module X
			Maw W	Maximum available active power from power module X [W]
Power	Output active power supplied by power module X, expressed as a percentage in relation to the maximum active power available from power module X [%]			
Max VA	Maximum apparent power available from power module X [VA]			
Appar.Power	Apparent power supplied by power module X, expressed as a percentage in relation to the maximum apparent power available from power module X [%]			

(continue)

6. Control panel

PM Status	PM Measures	Battery X	Voltage	Battery voltage detected by power module X [V]
			Current	Current required to the batteries by power module X (negative if the batteries are charging) [A]
			Charger	Status of the battery charger inside the power module X
		Misc. X	INV HSink Temp.	Temperature of power module X Inverter heat sink [°C]
			BST HSink Temp.	Temperature of power module X Booster/PFC heat sink [°C]
			Fan Speed	Fan speed of power module X expressed as a percentage [%]
			Pos.H.V.Bus	Voltage on the positive DC BUS of power module X [V]
	Neg.H.V.Bus	Voltage on the negative DC BUS of power module X [V]		
	PM History Data	Run Time	Total runtime	
		Batt.Time	Total runtime on battery mode	
		Chg.Time	Total battery charger runtime	
		Bypass int.	Total number of bypass interventions	
		Battery int.	Total number of transfers to battery mode	
		Dumper int.	Total number of dumper interventions	
		Mains High	Total number of times that the input line voltage has exceeded the maximum permitted value by the power module	
		Overheat N.	Total number of overheating	
		Overload N.	Total number of overloads	
		HVBus Run.N.	Total number of overvoltages on the BUS	
		OutDCLevel N.	Total number of presence of DC output voltages to the power module	

INDICATION

Press the ENTER key to change the X value that represents the power module number the data are read from. The X value starts from 0 that represents the first power module installed in the first tunnel at the top left.

Diagnostics (*)	PM errors recovery	This deletes the error memory detected in the power module. It deletes only the resettable errors.
------------------------	--------------------	--

PM SW update (*)	Update all PM	This allows the sequential and automatic update of the internal software in all the power modules. Press the ENTER key to start the procedure. If the update is not necessary, the message "PM SW Versions updated!" appears on the display. Press the ESC key to exit.
	Single PM SW update	This allows the internal software update of a single power module. Use the ARROW UP/DOWN keys to choose the module that has to be updated ('PM00' indicates the first power module installed in the first tunnel at the top left). Press the ENTER key to display a comparison between the software currently present in the selected module and the new software to be installed. Press the ENTER key to start the update procedure. When the update is complete, the message "PM SW Version updated!" appears on the display. Press the ESC key to exit.

(*) Available in the "Service Mode" only



CAUTION

Only a skilled technician is authorized to carry out an update.

6.4.4 Events

Events	Log View	All	This displays all the events
		Critical	This displays the events that have generated critical alarms
		Warning	This displays the events that have generated non-critical alarms
		Info	This displays the events that have generated simple warnings

6.4.5 Tools

Battery	Battery Test	Automatic	This performs a test on the batteries to check their status and performance
	Batt. Calibration	This calibrates the batteries, finding the discharge curve. For precise information about the battery charge status, it is necessary to perform the calibration in the following cases: - after installation and first start-up; - in case the batteries are replaced; - every six months after the first year of the EPS life.	
	Battery cycle	This carries out a battery test and their equalization to check the status, the performance and to maximise the battery life.	

Signalling Test (*)	This carries out the test of the status indicator signalling (green, orange and red) and of the acoustic notification.
----------------------------	--

LCD Display Test (*)	This performs the test of the alphanumeric display. Press the ENTER key to display all the available characters.
-----------------------------	--

(*) Available in the "Service Mode" only

Assistance	Display Identifier	This displays the code to communicate to the Technical Support Service.
	Use code	Enter the code provided by the Technical Support Service.

CM errors recovery	This deletes the error memory detected by the command board. It restores only the resettable errors.
---------------------------	--

6.4.6 Log Out

It is possible to set a password to prevent non-authorised personnel to modify the configuration. By choosing a password, it is necessary to enter a private session to modify the settings. At the end of the operations use the "Log Out" menu to leave the private session.

If the password has been forgotten, it is necessary to contact the LEGRAND Technical Support Service.

6. Control panel

6.5 POWER ON/OFF menu

When the EPS is on, it is possible to access a menu called POWER ON/OFF by pressing the ON/OFF pushbutton for less than 0,5 seconds.

The choices that can be made in this menu are the following:

L1 phase (**)	Press the ENTER key to access the submenu in which it is possible to choose whether to turn phase L1 on or off independently of the others. Press the ARROW UP/DOWN keys to choose the ON or the OFF value. Press the ENTER key to confirm the value. Press the ESC key to leave the submenu.
L2 phase (**)	Press the ENTER key to access the submenu in which it is possible to choose whether to turn phase L2 on or off independently of the others. Press the ARROW UP/DOWN keys to choose the ON or the OFF value. Press the ENTER key to confirm the value. Press the ESC key to leave the submenu.
L3 phase (**)	Press the ENTER key to access the submenu in which it is possible to choose whether to turn phase L3 on or off independently of the others. Press the ARROW UP/DOWN keys to choose the ON or the OFF value. Press the ENTER key to confirm the value. Press the ESC key to leave the submenu.
UPS	Press the ENTER key to access the submenu to switch the EPS off. Press the ENTER key again to switch the equipment off. Press the ESC key to leave the submenu.
Hot swap	Press the ENTER key to access a submenu to make the hot-swap substitution of the power modules.  CAUTION This operation CANNOT BE PERFORMED

(**) Available with the inverter set up as three independent phases only

6.6 Switching off the EPS



The shutdown procedure must be applied exclusively if the load is off or does not need to be supplied by the EPS.

There are two possible ways to shut down the UPS.

It is possible to shut down the UPS from the **POWER ON/OFF** menu or it is possible to perform the following procedure:

1. Keep the ON/OFF key pressed for at least two seconds.
2. The display shows the text "Turn off the UPS?". Press the ENTER key.
3. Wait for the shutdown operations to complete.

If a prolonged shutdown is planned, apply what is prescribed in chapter 9.

6.7 Switching on the EPS

The operator can turn the equipment on with the following procedure:

1. Press the ON/OFF key.
2. When the display shows the text "<ENTER> to confirm UPS turn ON", press the ENTER key. If no operation is carried out within 30 seconds, the EPS turns off.
If the display shows the message "WARNING: different UPS setup! <ENTER> to confirm UPS turn on", the EPS setup is different from the last power up. A skilled technician must check the setup before confirming the power up.
3. Wait for the power up operations to complete. The load is only supplied when the bar with the text "UPS initialize..." displayed reaches the end and the main screen appears.

7. Diagnosis

7.1 Luminous and audible notifications

The status indicator of the control panel and the led on the front of every power module change their colour according to the actual operating status of the EPS. This status is shown in the table below.

INDICATION

Some luminous notifications come with an audible notification. Press the ESC key to silence the buzzer. On every subsequent press, the buzzer is silenced or enabled.

INDICATION

If it is not possible to solve the problem, contact the LEGRAND Technical Support Service.

STATUS INDICATOR	POWER MODULE LED	AUDIBLE NOTIFICATION	STATUS MESSAGE	UPS STATUS DESCRIPTION AND OPERATING TIPS
GREEN Steady	GREEN Steady	-	Trimod MCS	Normal EPS operation with mains present, load within the limits and output enabled
GREEN Steady ORANGE Steady	ORANGE Flashing	-	TRIMOD MCS EPS in stand-by	Normal EPS operation with mains present, load within the limits and output disabled
-	-	-	3V Battery Fail	Contact the LEGRAND Technical Support Service
GREEN Steady ORANGE Flashing	ORANGE Flashing	-	Output/phase turned OFF	Phase OFF in configuration of 3 independent phases output. Check the output setup.
GREEN Steady ORANGE Flashing	-	-	Modules turned OFF	Command board in Hot Swap
GREEN Steady	1 module: Steady ORANGE Remaining modules: Steady GREEN	-	Equalizing Battery	Battery equalization in progress
GREEN Quick flashing	GREEN Quick flashing	-	-	Mains supply is absent on at least one power module and/or the frequency of the mains is not correct (>68Hz or <43Hz) and/or the input PLL is not synchronised. A skilled technician must check the input mains.
GREEN Quick flashing	-	-	-	One or more of the following problems are present: bypass absent, input PLL not synchronised, bypass voltage outside the limits, bypass three-phase circuit sequence not correct or reversed, bypass frequency out of tolerance. A skilled technician must check the bypass line.
GREEN Quick flashing	GREEN Quick flashing	-	Bypass line KO	The bypass line cannot be used to power the load
ORANGE Quick flashing	ORANGE Flashing	-	Forced on Bypass UPS on Bypass	Operation in forced bypass mode
ORANGE Steady	ORANGE Steady	ON 500 ms and OFF 12 s	UPS on Battery	Battery mode operation
ORANGE Steady	ORANGE Steady	-	Battery Cal..	Battery calibration in progress

continue...

7. Diagnosis

STATUS INDICATOR	POWER MODULE LED	AUDIBLE NOTIFICATION	STATUS MESSAGE	UPS STATUS DESCRIPTION AND OPERATING TIPS
ORANGE Steady	-	-	Battery Test...	Battery test in progress
ORANGE long intermittent	GREEN Steady	-	Make Maintenance	Contact the LEGRAND Technical Support Service
ORANGE long intermittent	GREEN Steady	-	Check Batteries	A skilled technician must check the battery status
ORANGE Quick flashing	ORANGE Flashing	-	Maintenance Bypass	Operation in manual bypass mode
ORANGE Short and double intermittent with pause	ORANGE Steady	Short intermittent blinks and double with pause	RUNTIME RESERVE!	Autonomy reserve during the battery mode operation
RED Steady	RED Steady only on the module with the fault	Quick flashing	FAULT CHARGER	Battery charger faulty on at least one power module. A skilled technician must replace the faulty module.
RED Steady	RED Steady only on the module with the fault	Quick flashing	FAULT MODULE	A skilled technician must replace the faulty power module.
RED Quick flashing	ORANGE Flashing	Quick flashing	BATTERIES KO	Batteries failed. A skilled technician must check the batteries.
RED Quick flashing	RED Quick flashing	Quick flashing	BATTERY DISCONNECTED	Batteries failed or not connected. A skilled technician must check the batteries.
RED Quick flashing	RED Short and double intermittent with pause	Quick flashing	BATTERY RUNAWAY	Excessive battery voltage. If the alarm persists over time a skilled technician must check the batteries.
RED Quick flashing	RED Short and double intermittent with pause	Quick flashing	HVBUS RUNAWAY FAIL	Contact the LEGRAND Technical Support Service
RED Quick flashing	RED Steady	Quick flashing	OUT DC LEVEL FAIL	Reset the power module error from the control panel in Service Mode (paragraph 6.4.3) and turn on the EPS. If the error persists, one or more power modules are faulty and a skilled technician must replace them.
RED Quick flashing	RED Short and double intermittent with pause only on the module in alarm	Quick flashing	OVERHEAT	Overheating of one or more power modules. Check the operation of the module fans and clean the air intake grilles.
RED Quick flashing	RED Short and double intermittent with pause only on the module in overload	Quick flashing	OVERLOAD	Overload on one or more power modules. Check the applied load.
RED Quick flashing	-	Quick flashing	CM FAILURE	Contact the LEGRAND Technical Support Service
RED Quick flashing	-	Quick flashing	Reference Error! or Reference Warning	Contact the LEGRAND Technical Support Service
RED Quick flashing	-	Quick flashing	BACKFEED	Contact the LEGRAND Technical Support Service

7.2 Messages

This paragraph shows the messages that appear on the control panel display or in the event list (see paragraph 6.4.4) and the probable cause that could have generated them.

INDICATION

If it is not possible to solve the problem, contact the LEGRAND Technical Support Service.

FIRST ROW OF THE MAIN SCREEN

MESSAGE	MEANING AND OPERATING TIPS
TRIMOD MCS	The EPS is operating properly
Service mode	EPS in Service Mode. The parameters can be modified through the control panel and updates can be made.
UPS initialize...	The EPS is starting-up
CM initialize...	The command board is starting-up all the associated power modules after the exit from the hot-swap mode.
CM turning off...	The command board is turning off all the associated power modules after entering the hot-swap mode
Service Mode...	The EPS is starting up in Service Mode.
Maintenance Bypass	The load is powered directly from the mains by means of the manual bypass.
Forced on Bypass	The EPS has entered the forced Bypass mode through a selection from the control panel.
UPS on Bypass	EPS in bypass mode.
Bypass line KO	A skilled technician must check the bypass line.
EPS in stand-by	Output non powered during normal functioning (with mains present)
Modules turned OFF	Command board in hot-swap. The power modules are no longer powered and ready to be replaced.
Output/phase turned OFF	Phase or Output off. Configuration obtained via display or after a EPS malfunctioning.
UPS on battery	EPS in battery mode. A fault in the equipment power supply system or a loss of mains has occurred.
UPS in off-line	The load is powered directly from the bypass line. In case of a power failure, the equipment switches to battery mode.
Battery Cal...	The EPS is performing the calibration of the batteries through a command from the control panel.
Battery Test...	The EPS is carrying out a test on the batteries in order to check their status and proper operation.
Equalizing Battery	The EPS is performing battery equalization.
Buzzer Muted	The buzzer has been silenced.
RUNTIME RESERVE!	The battery charge is low while the EPS is working in battery mode.
FAULT MODULE	One or more power modules are faulty. A skilled technician must replace them.

continue...

7. Diagnosis

MESSAGE	MEANING AND OPERATING TIPS
BACKFEED	A backfeed error has been detected. Contact the LEGRAND Technical Support Service.
FAULT CHARGER	The battery charger circuit of one or more power modules is faulty. A skilled technician must replace them.
BATTERIES KO	Batteries failed. A skilled technician must check their status and replace them if necessary.
BATTERY DISCONNECTED	The EPS detects a battery voltage lower than 10 V. A skilled technician must verify the batteries and the cabling.
STRONG OVERLOAD	The load has caused an excessive lowering of the output voltage.
OVERLOAD	The load is higher than the rated power of the EPS.
OVERHEAT	The temperature inside the EPS is outside the nominal range. Check the operation of the module fans and clean the air intake grilles.
OUT DC LEVEL FAIL	Reset the power module error from the control panel in Service Mode (paragraph 7.4.3) and turn on the EPS. If the error persists, one or more power modules are faulty and a skilled technician must replace them.
HVBUS RUNAWAY FAIL	Contact the LEGRAND Technical Support Service.
BATTERY RUNAWAY	The battery voltage is out of control. A skilled technician must check the status of the batteries and of the battery charger.
3V Battery Fail	The 3V battery of the command board is exhausted. Contact the LEGRAND Technical Support Service.
Abnormal batt.drain	Abnormal battery drain. Contact the LEGRAND Technical Support Service.
Check Batteries	A skilled technician must check the battery status.
Make Maintenance	Contact the LEGRAND Technical Support Service.
Shutdown ongoing...	The EPS is shutting down after being programmed to do so by the user
Charging Battery	The EPS is charging the batteries. The charging mode is indicated next to the message.
UPS EMERGENCY!	Contact the LEGRAND Technical Support Service.
LOAD TURNED OFF!	A prolonged excessive load (e.g. a short circuit) has caused a significant lowering of the output voltage and the load is no longer powered or the load has been shut down because of an extended overload in battery mode.
UPS TURNED OFF!	The EPS is turning off due to a command given from the control panel.
UPS BLOCKED!	Contact the LEGRAND Technical Support Service.
PM FW not updated!	One or more power modules have the software not compatible with the command board. Update the modules before turning on the EPS.
Reference Error!	Synchronisation error among the command boards. Contact the LEGRAND Technical Support Service.
CM FAILURE	Communication error among the command boards. Contact the LEGRAND Technical Support Service.
Reference Warning	Synchronisation error among the command boards. Contact the LEGRAND Technical Support Service.

ALARMS

MESSAGE	MEANING
INVERTER FAIL	Fault detected in the Inverter circuit. One or more power modules are faulty. A skilled technician must replace them.
BOOSTER FAIL	Fault occurred in the Booster/PFC circuit. One or more power modules are faulty. A skilled technician must replace them.
CHARGER FAIL	Fault occurred in the Battery charger circuit. One or more power modules are faulty. A skilled technician must replace them.
OVERHEAT	Overheating. Check the ventilation system.
OVERLOAD	Overload. Check the connected load level.
HVBUS RUNAWAY	Contact the LEGRAND Technical Support Service
OUTPUT DC LEVEL ERROR	A skilled technician must check that there is not a faulty power module or a voltage backfeed from the output.
BATTERY VOLTAGE TOO HIGH	Excessive battery voltage. A skilled technician must check the batteries.
MODULE COMMUNICATION FAIL PM -> CM	Failure in the communication with the power modules. Contact the LEGRAND Technical Support Service.
BATTERY WIRING FAIL	Error in the battery connection with the power modules. One or more modules are faulty. A skilled technician must replace them.
MAINS WIRING FAIL	Error in the mains connection with the power modules. One or more modules are faulty. A skilled technician must replace them.
H.V.BUS WIRING FAIL	Error in the DC bus connection with the power modules. One or more modules are faulty. A skilled technician must replace them.
BATTERY DISCONNECTED OR POLARITY INVERTED	The batteries were not connected correctly or the polarity has been inverted
MODULE COMMUNICATION FAIL CM -> PM	Failure in the communication with the power modules. Contact the LEGRAND Technical Support Service.
UNPROTECTED LOAD	Load not protected
MAKE MAINTENANCE	Contact the LEGRAND Technical Support Service
CHECK BATTERIES	A skilled technician must check the battery status
REFERENCE ERROR OVER CAN NETWORK!	Synchronisation failure among the command boards. Contact the LEGRAND Technical Support Service.
CM FAILURE ON CAN NET	Synchronisation failure among the command boards. Contact the LEGRAND Technical Support Service.
BACKFEED	A backfeed error has been detected. Contact the LEGRAND Technical Support Service.
ABNORMAL BATTERY DRAIN	Abnormal battery drain. Contact the LEGRAND Technical Support Service.

7. Diagnosis

SCREEN DISPLAYED ON START-UP OR SHUT DOWN

MESSAGE	MEANING AND OPERATING TIPS
First Turn ON: Supply Mains!	The EPS has never been turned on. No mains input. Start-up not permitted. Make sure the mains is present before turning on.
Mains not Present! Startup not Allowed	No mains input. Start-up not permitted. To start the EPS in battery mode select this configuration from the control panel (paragraph 6.4.2).
Emergency Power Off!	The Emergency Power Off (EPO) has been activated. The EPO command has been sent by a pushbutton or a disconnect switch on the input line has been opened during the operation of the EPS. Check the emergency pushbutton.
Incomplete Setup for start-up!	The EPS requires a complete configuration for start-up. Check that the output configuration, bypass enabling, number of KB, number of batteries per KB and output voltage have been inserted properly.
Three Phase Voltage Sequence Invalid!	The three phase input sequence is not valid. A skilled technician must check that the input three phase system has been correctly connected.
Invalid PM SW Versions: ← to execute update	The SW versions of some or of all the power modules are not correct. Press the ENTER key to update. At the end of the update, the EPS continues the start-up procedure.
Invalid PM HW Versions!	One or more power modules are not compatible with the EPS. Contact the LEGRAND Technical Support Service.
START UP Error!	An error has occurred during the start-up procedure of the EPS. Contact the LEGRAND Technical Support Service.
Startup aborted	The EPS start-up has not been confirmed from the control panel within 30 seconds after the confirmation request of the start-up procedure.
UPS turned off by program!	EPS shut down as programmed via software in a remote control system
Incorrect setup turn-off	An error has occurred during the configuration. EPS is shutting down. One or more parameters have not been set properly. Check the configuration from the control panel.
Incorrect KB setup turn-off	An error has occurred during the configuration of the number of KB. Set the right number of KB from the control panel (paragraph 6.4.2)
Low Battery TurnOff	EPS shutdown during battery mode because the minimum voltage level of the batteries has been reached.
Battery Start up Failed. Check polarity.	The batteries are not connected to the EPS or the BUS is not properly charged. A skilled technician must check the batteries.
Battery Time Expired	EPS shutdown during battery mode because the maximum battery operating time set from the control panel has been reached (paragraph 6.4.2)
Load turned OFF	The load power has been cut off
Powered from Output	Start-up error. Voltage present on the equipment output. A skilled technician must check the connections.
Turned Off with charged H.V.bus	The EPS has not shutdown properly. Make sure the DC buses are discharged before performing any maintenance operation.
Saving NVDData error	Error saving some EPS parameters. If the problem persists, contact the LEGRAND Technical Support Service.
Invalid CM SW Versions: Execute update!	The command boards have been programmed with different software versions. The software versions must be aligned by carrying out an update of the command boards through a PC.

MESSAGES DISPLAYED ON START-UP

MESSAGE	MEANING AND OPERATING TIPS
WARNING: alarm records in memory!	It is necessary to confirm the turning on of the EPS in presence of alarms in the even list
WARNING: different UPS setup!	The EPS configuration has changed from the last power up. A skilled technician must check the setup before confirming the power up.
Maintenance Bypass! Open output	Open the output breaker before turning on the EPS to exit the manual maintenance bypass mode.
Turn ON after low battery turn OFF.	The EPS is turned on after a previous end of autonomy
<ENTER> to confirm UPS turn ON	Press the ENTER key to turn on the EPS

CRITICAL EVENTS (paragraph 6.4.4)

MESSAGE	MEANING AND OPERATING TIPS
Inverter Fail	Fault detected in the Inverter circuit. One or more power modules are faulty. A skilled technician must replace them.
Booster Fail	Fault detected in the Booster/PFC circuit. One or more power modules are faulty. A skilled technician must replace them.
Battery Charger Fail	Fault detected in the Battery charger circuit. One or more power modules are faulty. A skilled technician must replace them.
Overheat	Overheating. Check the ventilation system.
Overload	Overload. Check the connected load level.
H.V.Bus Runaway Failure	Contact the LEGRAND Technical Support Service
Output DC Level	A skilled technician must check that there is not a faulty power module or a voltage backfeed from the output
Battery voltage too high	Excessive battery voltage. A skilled technician must check the batteries.
Power Module comm. failure	Contact the LEGRAND Technical Support Service
Emergency	Contact the LEGRAND Technical Support Service
Load turned OFF	The output load power has been cut off
Irregular TurnOff	EPS shutdown in an anomalous way. The skilled technician must make sure that there is no voltage inside the equipment before performing any maintenance operation.
Overload TurnOff	EPS shutdown due to an extended overload
Emergency Power Off turn-OFF	EPS shutdown due to an Emergency Power Off
Battery KO	Fault in the batteries. A skilled technician must check them.
Power Module battery wiring failure	There is a fault in the connection of the batteries to the power modules. One or more power modules are faulty. A skilled technician must replace them.
Power Module mains wiring failure	There is a fault in the connection of the mains to the power modules. One or more power modules are faulty. A skilled technician must replace them.

continue...

7. Diagnosis

MESSAGE	MEANING AND OPERATING TIPS
Power Module HVBus wiring failure	There is a fault in the connection of the HVBus to the power modules. One or more power modules are faulty. A skilled technician must replace them.
Communication failure between CM	Communication error among the command boards. Contact the LEGRAND Technical Support Service.
Backfeed	A backfeed error has been detected. Contact the LEGRAND Technical Support Service.
Abnormal battery drain	Abnormal battery drain. Contact the LEGRAND Technical Support Service.

NOTIFICATION EVENTS (paragraph 6.4.4)

MESSAGE	MEANING AND OPERATING TIPS
Low Battery TurnOff	EPS shutdown due to autonomy end during the battery mode operation.
Invalid sequence turn-OFF	EPS shutdown due to incorrect three phase sequence on input. A skilled technician must check that the input three phase system has been correctly connected.
Battery calibration aborted	Battery calibration interrupted by the user
Battery Time Expired	Shutdown of the EPS because the maximum battery operating time set from the control panel has been reached (paragraph 6.4.2)
StartUP error	Start-up error.
Start-up granted with alarms	EPS start-up authorised in presence of alarms
Start-up granted with new cfg	EPS start-up authorised with new configuration. The number of power modules installed on the UPS has changed.
Incorrect setup turn-off	EPS shutdown because the configuration is wrong. The number of power modules detected by the EPS is not correct for the output configuration set.
PM firmware updated	Power module software updated
Strong overload	Strong overload
Powered from Output	Voltage present on the EPS output. A skilled technician must check the connections.
Turned Off with charged H.V.bus	The EPS has not shutdown properly. The EPS has shutdown without completely discharging the buses.
Make Maintenance	Contact the LEGRAND Technical Support Service.
Check Batteries	A skilled technician must check the batteries.
Replace batteries	A skilled technician must check the battery status and change the batteries if necessary.
Low Battery Emergency	The load is powered directly from the bypass line due to an end of autonomy
Charge finished	Faulty operation of the battery charger. Contact the LEGRAND Technical Support Service.
Battery disconnected or polarity inverted	The batteries were not connected correctly or the polarity has been inverted

INFORMATIVE EVENTS (paragraph 6.4.4)

MESSAGE	MEANING
User Turn ON	User start-up of the EPS
User Turn OFF	User shutdown of the EPS
Auto turn ON	Automatic EPS start-up
Timed turn OFF	The EPS has been shut down via the delayed shutdown programming (paragraph 6.4.2)
Stand-by battery charge start	The battery charger has started in EPS stand-by mode
UPS on battery	The EPS has transferred to battery operation mode
UPS on mains	The EPS has transferred to mains operation mode
Line Out turned OFF	The EPS output has been shut down
Battery test executed	Battery testing successfully completed
Battery learning executed	Battery calibration successfully completed
Forced Bypass ON	The forced bypass operation mode has been enabled
Forced Bypass OFF	The forced bypass operation mode has been disabled
Maintenance Bypass ON	The load is powered directly from the manual bypass disconnect switch
Maintenance Bypass OFF	The load is no longer powered directly from the manual bypass disconnect switch
Enter in Hot Swap	The equipment has started-up the hot-swap mode
Exit from Hot Swap	The equipment has exited the hot-swap mode
Event list erased	The event list has been erased
Battery replaced	The batteries have been replaced by the LEGRAND Technical Support Service

8. Installation and maintenance



INSTALLATION and ORDINARY MAINTENANCE operations must be carried out only by SKILLED TECHNICIANS (paragraph 2.2.1). The EXTRAORDINARY MAINTENANCE operations must be carried out only by the LEGRAND TECHNICAL SUPPORT SERVICE.

8.1 Introduction

This chapter contains all the information necessary for an operator to correctly install and maintain the EPS.



The operator is not authorised to perform the operations contained in the installation and maintenance manual. LEGRAND declines all liability for any injury or damage caused by activities carried out differently from the instructions in this manual or by a skilled technician who does not observe the requirements laid down in the installation and maintenance manual.

8.2. Installation

The operator is not authorized to install and electrically connect the EPS. These operations are the sole preserve of a skilled technician (paragraph 2.2.1) who must follow the instructions addressed to him in the installation and maintenance manual.

8.3 Preventive maintenance

The EPS does not contain parts for preventative maintenance by the operator.

The operator must periodically perform:

- a normal general external cleaning;
- a check to verify the absence of alarms on the display;
- a check to verify the correct operation of the fans on each power module.

After the first year of EPS life, check the batteries every six months through the "battery calibration" function to guarantee the optimal operation and continuous protection of the connected load. With this function, the EPS detects the discharge curve of the batteries in order to provide precise information on the charging status.

To activate the function enter the main menu and follow the path **Tools → Batteries → Batt. Calibration**

Press the ENTER key to confirm the choice.

Contact the LEGRAND Technical Support Service in case of problems.

8.4 Periodical checks

The correct EPS operation must be guaranteed by periodical maintenance inspections. These are essential to safeguard the EPS reliability.



The periodical checks involve operations inside the EPS in presence of dangerous voltages. Only maintenance personnel trained by LEGRAND are authorized to work.

8.5 Ordinary maintenance

Contact a skilled technician if it is necessary to replace or add power modules, battery drawers for modular Trimod MCS BATTERY or batteries for non-modular Trimod BATTERY.

8.6 Extraordinary maintenance

Contact the LEGRAND Technical Support Service if faults have occurred which require access to internal parts of the EPS.

9. Warehousing



DANGER

All storage operations must be carried out only by a SKILLED TECHNICIAN (paragraph 2.2.1)



DANGER

The SKILLED TECHNICIAN must check that there is no voltage present before disconnecting the cables. All the battery breakers on the EPS and on the external battery cabinets must be open. The modular Trimod MCS BATTERY battery drawers (if present) and the EPS battery drawers (according to the model) must be removed.

9.1 EPS

The EPS may be stored in an environment with a temperature between -20°C (-4°F) and +50°C (+122°F) and humidity less than 90% (not condensing).

9.2 Batteries

It is possible to store batteries without recharging them in the following conditions:

- 6 months at +20°C (+68°F);
- 3 months at +30°C (+86°F);
- 2 months at +35°C (+95°F).

For the recharging of the battery contact a qualified technician.



CAUTION

The battery drawers or the external Trimod MCS BATTERY battery cabinets must never be stored if the batteries are partially or totally discharged.

LEGRAND is not liable for any damage or bad operation caused to the EPS by wrong warehousing of the batteries.

10. Dismantling



DANGER

Dismantling and disposal operations must be carried out only by a **SKILLED TECHNICIAN** (paragraph 2.2.1). The instructions in this chapter are to be considered indicative: in every country there are different regulations with regard to the disposal of electronic or hazardous waste such as batteries. It is necessary to strictly adhere to the standards in force in the country where the equipment is used. Do not throw any component of the equipment in the ordinary rubbish.

10.1 Battery disposal

Batteries must be disposed of in a site intended for the recovery of toxic waste. Disposal in the traditional rubbish is not allowed.

Apply to the competent agencies in your country for the proper procedure.



Pb



WARNING

A battery may constitute a risk of an electric shock and high short-circuit current. When working on batteries, the prescriptions indicated in chapter 2 must be adhered to.

10.2 EPS dismantling

The dismantling of the EPS must occur after the dismantling of the various parts it consists of.

For the dismantling operations, it is necessary to wear the Personal Protective Equipment mentioned in paragraph 2.3 and to consult the instructions and diagrams in the installation and maintenance manual.

Sub-divide the components separating the metal from the plastic, from the copper and so on according to the type of selective waste disposal in the country where the machine is dismantled.

If the dismantled components must be stored before their disposal, be careful to keep them in a safe place protected from atmospheric agents to avoid soil and groundwater contamination.

10.3 Electronic component dismantling

For the disposal of electronic waste like the control panel or the command boards, it is necessary to refer to the relevant standards.



This symbol indicates that in order to prevent any negative effects on the environment and on people, this product should be disposed of separately from other household waste, by taking it to authorised collection centres, in accordance with the EU countries local waste disposal legislations. Disposing of the product without following local regulations may be punished by law. It is recommended to check that this equipment subject to WEEE legislations in the country where it is used.

11. Technical data

Main features

	Trimod MCS 3	Trimod MCS 5	Trimod MCS 7	Trimod MCS 10	Trimod MCS 15	Trimod MCS 20	Trimod MCS 30	Trimod MCS 40	Trimod MCS 60	Trimod MCS 80
Nominal power	3.4 kVA	5 kVA	6.7 kVA	10 kVA	15 kVA	20 kVA	30 kVA	40 kVA	60 kVA	80 kVA
Active Power	3.4 kW	5 kW	6.7 kW	10 kW	15 kW	20 kW	30 kW	40 kW	60 kW	80 kW
Active power according to EN50171	2.83 kW	4.16 kW	5.58 kW	8 kW	12.5 kW	16.7 kW	25 kW	33.3 kW	50 kW	66.7 kW
Technology	Classification according to EN62040-3: VFI-SS-111									
IN/OUT Configuration	Single-phase / Single-phase			Single-phase / Single-phase - Single-phase / Three-phase Three-phase / Single-phase - Three- phase / Three-phase (may be configured by a skilled technician)				Three-phase / Three-phase		
Dual Input	Available on all the models									
Command boards	1									
EPS architecture	Modular with power modules PF=1 Expandable, redundant N+X									
Neutral system	Neutral passing straight from input to output (not isolated)									
Bypass	Automatic (static and electromechanical) Manual (for maintenance)									

Input electrical characteristics

	Trimod MCS 3	Trimod MCS 5	Trimod MCS 7	Trimod MCS 10	Trimod MCS 15	Trimod MCS 20	Trimod MCS 30	Trimod MCS 40	Trimod MCS 60	Trimod MCS 80
Maximum three-phase/ three-phase current	-	-	-	19.2 A	28.8 A	38.4 A	57.6 A	76.8 A	115.2 A	153.6 A
Maximum three-phase/ single-phase current	-	-	-	19.2 A	28.8 A	38.4 A	57.6 A	-	-	-
Maximum single phase/single phase current	-	-	-	57.6 A	86.4 A	115.2 A	172.8 A	-	-	-
Maximum single- phase/single-phase current	19.5 A	28.7 A	38.5 A	57.6 A	86.4 A	115.2 A	172.8 A	-	-	-
Rated input voltage	230 V + 15% - 20% (Single-phase)			230 V + 15% - 20% (Single-phase) 400 V + 15% - 20% (Three-phase) (neutral line indispensable)				400 V + 15% - 20% (Three-phase) (neutral line indispensable)		
Input frequency	50 / 60 Hz ± 2% 50 / 60 Hz ± 14 % (autosensing and/or selectable by the user)									
Power factor on input	> 0.99									
Total harmonic distortion of the input current	THDi < 3%									

11. Technical data

Electrical output characteristics (normal mode)

	Trimod MCS 3	Trimod MCS 5	Trimod MCS 7	Trimod MCS 10	Trimod MCS 15	Trimod MCS 20	Trimod MCS 30	Trimod MCS 40	Trimod MCS 60	Trimod MCS 80
Maximum three-phase/ three-phase current	-	-	-	14.5 A	21.7 A	29 A	43.5 A	58 A	87 A	116 A
Maximum three-phase/ single-phase current	-	-	-	43.5 A	65.2 A	87 A	130.5 A	-	-	-
Maximum single phase/single phase current	-	-	-	14.5 A	21.7 A	29 A	43.5 A	-	-	-
Maximum single- phase/single-phase current	14.8 A	21.7 A	29.2 A	43.5 A	65.2 A	87 A	130.5 A	-	-	-
Rated output voltage	230 V ± 1% (Single-phase)			230 V ± 1% (Single-phase) 400 V ± 1% (Three-phase)			400 V ± 1% (Three-phase)			
Rated output frequency	50 / 60 Hz									
Tolerance on the output frequency	If synchronised with the input frequency: adjustable range from ±1% to ±14% If not synchronised: ± 1%									
Crest factor admitted on the output current	3:1									
Efficiency (AC/AC on-line)	up to 96%									
Efficiency ECO mode	99% max									
Overload admitted	120% continuously without automatic bypass intervention 135% for 10 minutes without automatic bypass intervention 150% for 60 seconds without automatic bypass intervention									

Electrical output characteristics (battery mode)

	Trimod MCS 3	Trimod MCS 5	Trimod MCS 7	Trimod MCS 10	Trimod MCS 15	Trimod MCS 20	Trimod MCS 30	Trimod MCS 40	Trimod MCS 60	Trimod MCS 80
Rated output voltage	230 V ± 1% (Single-phase)			230 V ± 1% (Single-phase) 400 V ± 1% (Three-phase)			400 V ± 1% (Three-phase)			
Rated output frequency	50 / 60 Hz ± 1%									
Total harmonic distortion of output voltage on non-linear nominal load	< 1%									
Overload admitted	120% until end of autonomy 135% for 2 minutes 155% for 30 seconds									

Batteries and Battery Charger Characteristics

	Trimod MCS 3	Trimod MCS 5	Trimod MCS 7	Trimod MCS 10	Trimod MCS 15	Trimod MCS 20	Trimod MCS 30	Trimod MCS 40	Trimod MCS 60	Trimod MCS 80
Battery type	Long-life maintenance-free sealed lead-acid (VRLA); life expectancy 10 years									
Unitary capacity	Battery drawers: 5 batteries 12Vdc - 9Ah Non-modular external battery cabinets: 20 batteries 12Vdc - 94Ah									
Rated battery voltage	240 Vdc (20 batteries 12V in series)									
Type of battery charger	High performance PWM, one for each power module									
Recharge curve	Smart Charge, advanced three-stage cycle									
Battery charger nominal recharge current	2.5 A max for every power module installed									
Charging time (EN50171)	12 h max									

	3 109 90 Trimod MCS 3	3 109 91 Trimod MCS 5	3 109 92 Trimod MCS 7	3 109 93 Trimod MCS 10	3 109 94 Trimod MCS 15	3 109 95 Trimod MCS 20	3 109 96 Trimod MCS 30	3 109 97 Trimod MCS 40	3 109 98 Trimod MCS 60	3 109 99 Trimod MCS 80
Minimum number of batteries to guarantee an autonomy of 1 h (EN50171) *	8 battery drawers	12 battery drawers	16 battery drawers	24 battery drawers (12 in the EPS + 12 in the external modular battery cabinet 4KB)	36 battery drawers (16 in the EPS + 20 in the external modular battery cabinet 5KB)	1 external non-modular battery cabinet	2 external non-modular battery cabinet	2 external non-modular battery cabinet	3 external non-modular battery cabinet	4 external non-modular battery cabinet

*1h autonomy only guaranteed for the item codes listed in the table

Features

	Trimod MCS 3	Trimod MCS 5	Trimod MCS 7	Trimod MCS 10	Trimod MCS 15	Trimod MCS 20	Trimod MCS 30	Trimod MCS 40	Trimod MCS 60	Trimod MCS 80
Signals and alarms	Large four line alphanumeric screen, multicolour status indicator, acoustic notification									
Communication ports	2 x RS 232 ports, 1 relay interface, 1 contact port, 1 SMNP module slot									
Protections	Electronics against overloads, short-circuit and excessive battery discharge Block of functions due to the end of autonomy In-rush limiter on start up EPO contact Auxiliary contact for Backfeed protection									

11. Technical data

Mechanical characteristics

	3 110 00 Trimod MCS 3	3 110 00 Trimod MCS 5	3 110 00 Trimod MCS 10	3 110 01 Trimod MCS 20	3 110 03 Trimod MCS 30	3 110 04 Trimod MCS 40	3 110 05 Trimod MCS 60
Net weight (without batteries and power modules)	87 kg			90 kg	86 kg	83 kg	92 kg
Dimensions in mm (w x h x d)	414 x 1370 x 628						
3400 VA power modules installed	1	-	3	-	-	-	-
5000 VA power modules installed	-	1	-	-	6	-	-
6700 VA power modules installed	-	-	-	3	-	6	9
Power module net weight	8.5 kg						
Battery drawer net weight	13.3 kg			-	-	-	-

	3 110 02 Trimod MCS 7	3 110 02 Trimod MCS 15	3 110 06 Trimod MCS 80
Net weight (without batteries and power modules)	105 kg		122 kg
Dimensions in mm (w x h x d)	414 x 1650 x 628		
3400 VA power modules installed	-	-	-
5000 VA power modules installed	-	3	-
6700 VA power modules installed	1	-	12
Power module net weight	8.5 kg		
Battery drawer net weight	13.3 kg		-

	3 110 07 Trimod MCS Battery Cabinet 4KB	3 106 16 Trimod MCS Battery Cabinet 5KB	3 108 08 3 108 09 3 108 10 3 108 11 Trimod Battery Cabinet 94Ah
Net weight (without batteries)	82 kg	96 kg	100 kg
Dimensions in mm (w x h x d)	414 x 1370 x 628	414 x 1650 x 628	600 x 1635 x 800
Battery drawer weight	13.3 kg		-
Weight of each 94Ah battery	-		32.6 kg

Environmental conditions

	Trimod MCS 3	Trimod MCS 5	Trimod MCS 7	Trimod MCS 10	Trimod MCS 15	Trimod MCS 20	Trimod MCS 30	Trimod MCS 40	Trimod MCS 60	Trimod MCS 80
Operating temperature	0 ÷ 40 °C									
Relative humidity during operation	0% ÷ 95% non condensing									
Storage temperature	-20°C ÷ 50 °C (excluding batteries)									
Noise level at 1 metre	58 ÷ 62 dB									
Protection index	IP 20									
Operating height	up to 1000 metres above sea level without derating									

Trimod MCS 3 108 51 battery charger module (BCM) technical specifications

Rated input voltage	230 Vac + 15% - 20%
Rated input current	19.3 A
Input Power Factor	PF > 0.99
Total harmonic distortion of the input current	THDi < 3%
Rated output voltage	240/252 Vdc
Output voltage in maintenance phase	13.75 Vdc per battery
Rated output current	15 Adc max
AC/DC performance	>93% at max rated output current
Operating status indications (signalled by multicoloured LED on module and indications on the display)	Yellow LED, fast flashing: recharge phase f1 Green LED, slow flashing: recharge phase f2 and maintenance Green LED steady: standby Red LED: fault status

Reference directives and standards

CPSS	EN 50171
Safety	2014/35/EU directive EN 62040-1
EMC	2014/30/EU directive EN 62040-2
Performance and test requirements	EN 62040-3

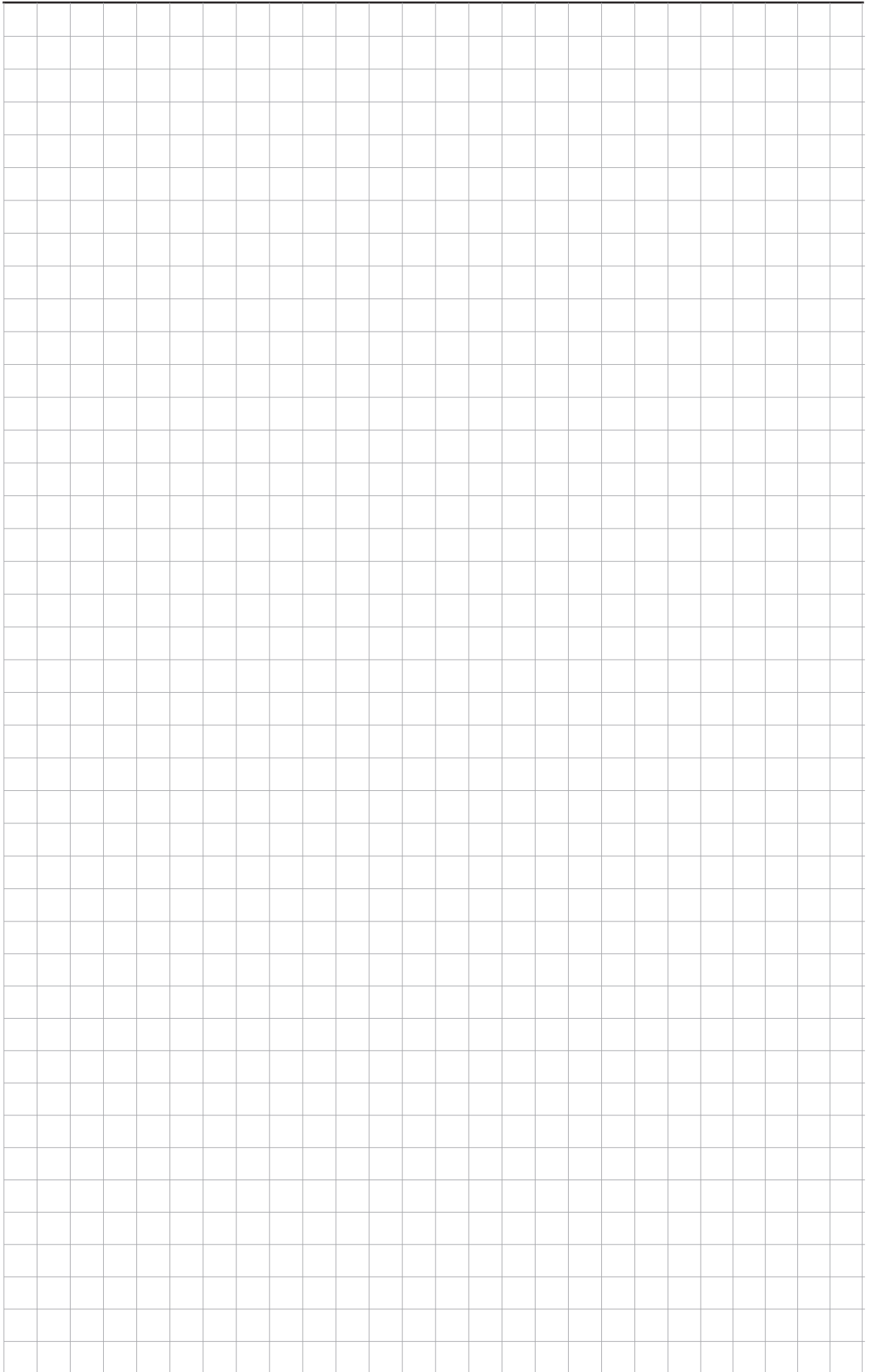



LEGRAND
Pro and Consumer Service
BP 30076 - 87002
LIMOGES CEDEX FRANCE
www.legrand.com

┌ Installer stamp ─┐

└ ─────────────────┘