

This pack enables you to create a switched power outlet in your home. You can complete this pack with the compatible products in the Céliane with Netatmo range: power outlets, light switches, lighting micromodules and wireless light switches sold separately.

Pack contents

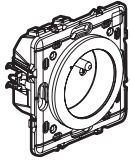

Pre-paired power outlet

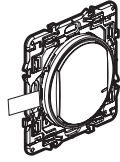

Pre-paired wireless light switch

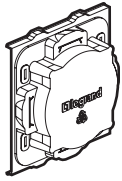

Site protection

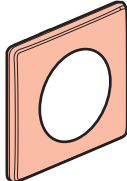

Finishing plate x 2



x 4

Removable stickers

⚠ Safety instructions

This product should be installed in compliance with installation rules, preferably by a qualified electrician. Incorrect installation and/or incorrect use can lead to risk of electric shock or fire. Before carrying out the installation, read the instructions and take account of the product's specific mounting location. Do not open up, dismantle, alter or modify the device except where specifically required to do so by the instructions. All Legrand products must be opened and repaired exclusively by personnel trained and approved by Legrand. Any unauthorised opening or repair completely cancels all liabilities and the rights to replacement and guarantees. Use only Legrand brand accessories.

LET0712AA

Before you start: wiring precautions

To control a power outlet, only use the following products:

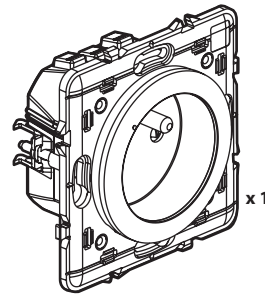

Power outlet (included in this pack)

AND

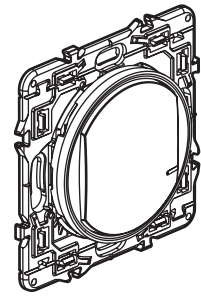

Wireless light switches (one wireless switch included in this pack)

If you are replacing a power outlet controlled by a switch:

Tip if you are replacing an old flush-mounted switch (replaced with a wireless switch)

Use a **connector** to connect the two wires.

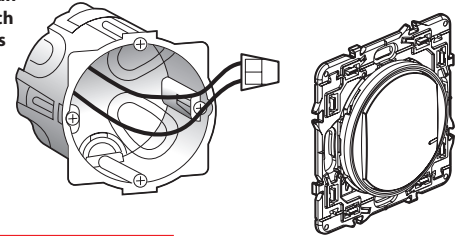

⚠ The circuit must be protected by a 16 A circuit breaker.

2

1 Necessary safety precautions



OFF
Switch off the power at the main circuit breaker.

2 **⚠ Make sure that the power is off before continuing with the installation.**

2 Install the power outlet

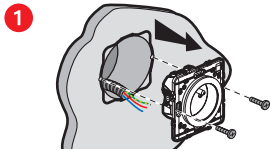

Remove the existing power outlet.

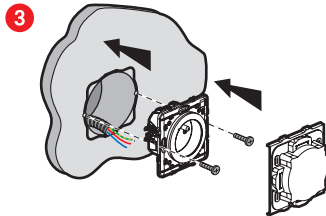

2 Wire the power outlet.

2.5 mm² rigid wire (recommended)

**16 A - 230 V~
3680 W max
cos 0.8**

Frequency bands: 2.4 - 2.4835 GHz
Power level: < 100 mW

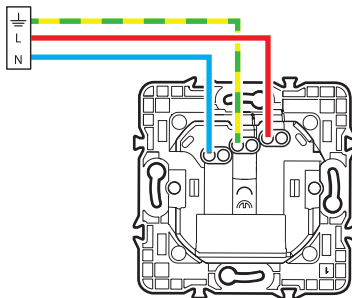

— N (neutral) = blue
— L (live) = any except blue and green/yellow
— ⊕ (earth) = green/yellow

3

3 Power up the power outlet

⚠ Mandatory installation step:



Turn the power back on at the main circuit breaker.

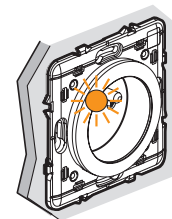

2 The power outlet indicator light flashes orange.

4

4 Install the wireless switch included in this pack

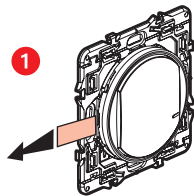

Take the wireless switch **included in this pack**. Remove the protective strip from the battery to power up the switch.

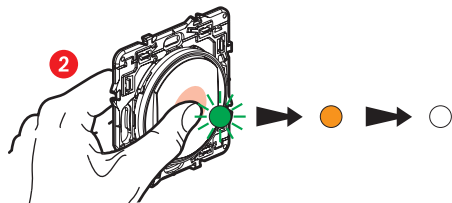

Press the wireless switch **briefly** to activate it. The indicator light will flash green and then turn permanently orange, then switch off.

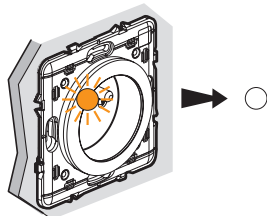

The indicator light on the **power outlet** supplied in the pack goes off.
The controlled power outlet is now functional.

5

If you want to add one or more wireless switches, go straight to step 8.

5 You want to add one or more wired products



Power outlet

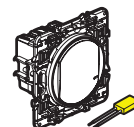

Light switch + bleeder

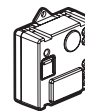

Lighting micromodule

Wire the wired products using the individual user instructions provided in the packaging for each of them.

6 Power the wired products



Turn the power back on at the main circuit breaker.

You must power all the wired products simultaneously.

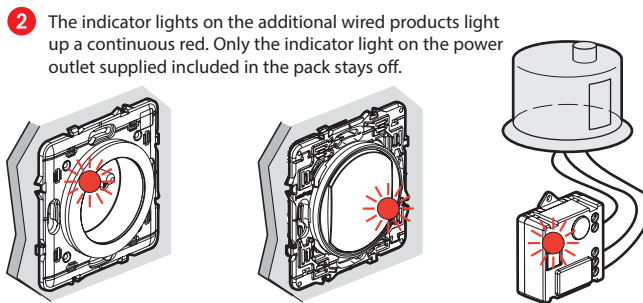

6

7 Start setting up the additional wired products

1 Press the button of the wireless switch already installed (it is included in the initial pack) in the centre, until its light briefly shines orange, **then release**.

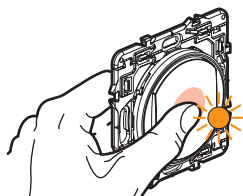

2 The indicator lights on the all products you have wired turn permanently orange one by one.

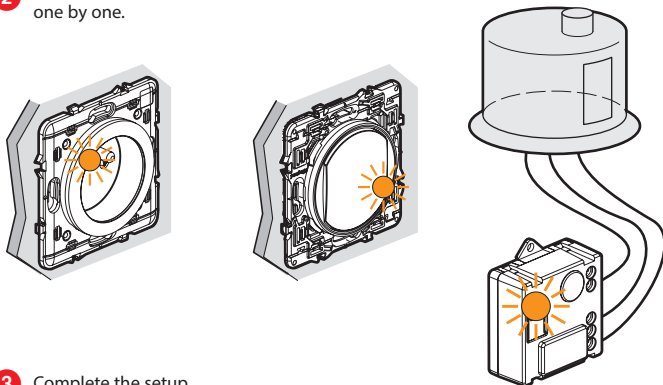

3 Complete the setup.

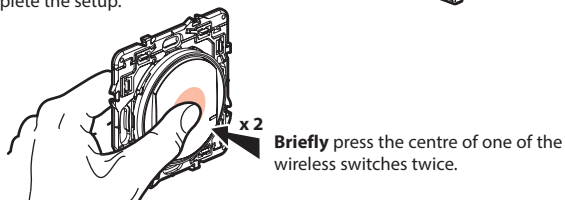

All the indicator lights on the products switch off.

The centralised control system is now functional. Any one of your wireless switches now controls all your wired products.

7

8 Install any additional wireless switches:

1 Press the button of the wireless switch already installed (it is included in the initial pack) in the centre, until its light briefly shines orange, **then release**.

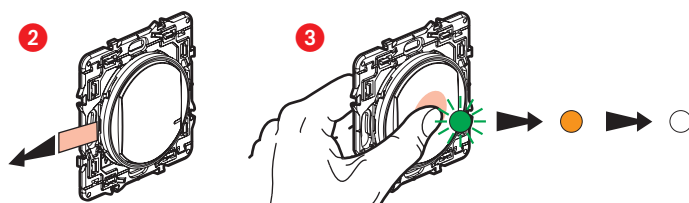
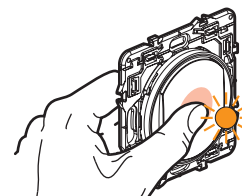

Remove the protective strips from each of the wireless switches.

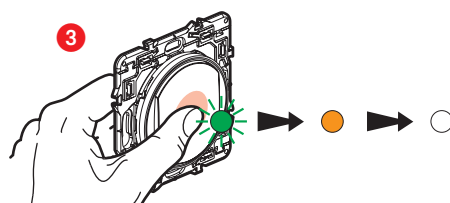

Briefly press each of the wireless switches to activate them. The indicator lights will flash green then light up permanently orange and then switch off.

4 Complete the setup.

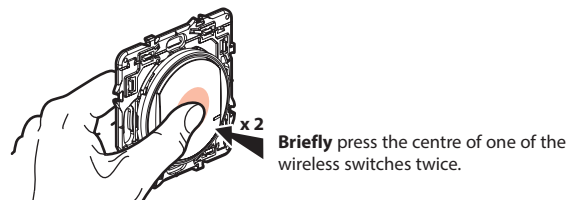

All the indicator lights on the products switch off.

The centralised control system is now functional. Any one of your wireless switches now controls all your wired products.

8

9 Attach the wireless switches

Attach the wireless switch(es) in the required places.

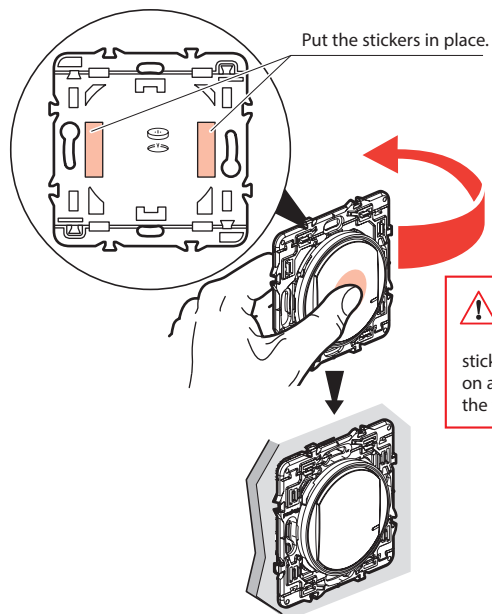

You can also attach the wireless switch(es) permanently to the wall with screws.

10 Install the finishing plates

Install the finishing plates on all of the products installed.

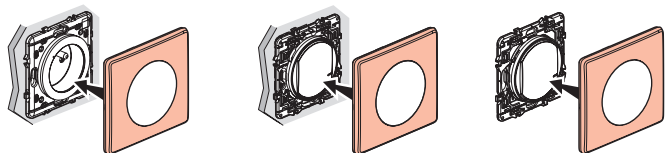

9



www.legrand.fr

LEGRAND - Pro and Consumer Service - BP 30076
87002 LIMOGES CEDEX FRANCE • www.legrand.com

Replacing the battery of a wireless switch

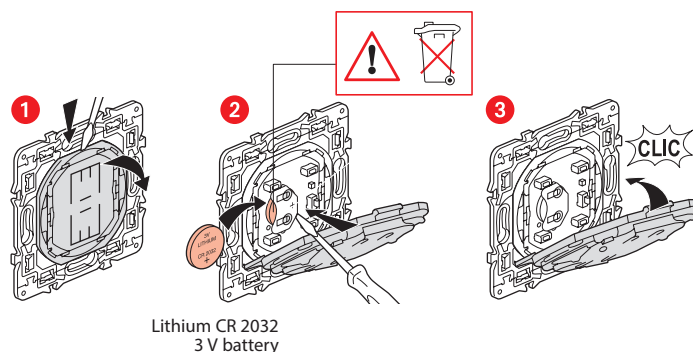

SIMPLIFIED EU DECLARATION OF CONFORMITY

The undersigned,

Legrand

declares that the radio-electric equipment referred to in these instructions complies with directive 2014/53/EU. The full text of the EU declaration of conformity is available on the following website:

www.legrandoc.com