

Connected power outlet

7 521 94 - 7 522 94 - 7 523 94



This pack is a connected accessory which **requires** you to buy and install the Valena Life with Netatmo connected starter pack first.

Pack contents

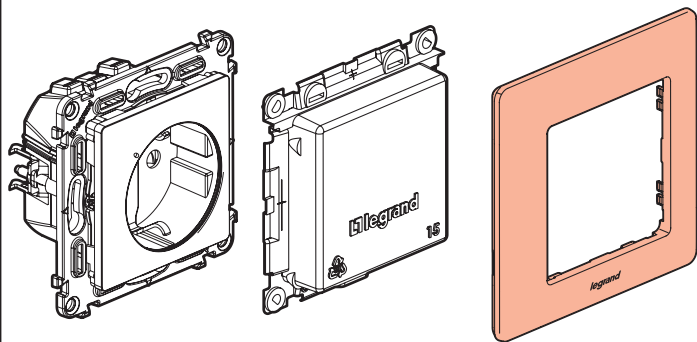

Connected power outlet

Site protection

Finishing plate

Safety instructions:

This product should be installed according to the installation regulations and preferably by a qualified electrician. Incorrect installation and/or use can entail risk of electric shock or fire. Before carrying out the installation, read the instructions and take account of the product's specific mounting location. Do not open, disassemble, alter or modify the device unless specified otherwise in the instructions. All **Legrand** products must be exclusively opened and repaired by personnel trained and approved by **Legrand**. Any unauthorised opening or repair completely cancels all liabilities and the rights to replacement and guarantees. Use only **Legrand** brand accessories.

Before you start: wiring precautions

To control a power outlet, only use the products:

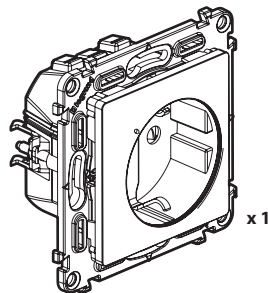

Connected power outlet

AND

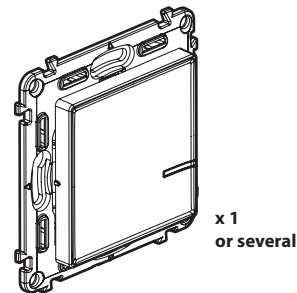

Wireless switches for all control points (not included in this pack)



Do not use: a connected switch (with dimmer option) to control a connected power outlet or a traditional power outlet.

If you are replacing a power outlet controlled by a switch:

Tip if you are replacing an old flush-mounted switch (replaced with a wireless switch)

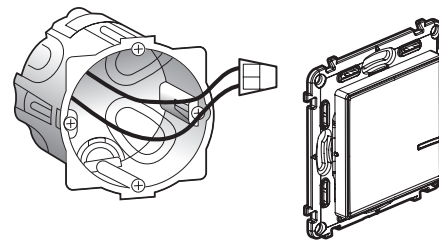

Use a **connector** to connect the two wires.



The head protection must be 16 A

LE1066AA

1 Necessary safety precautions

1

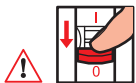

OFF

Switch off the power at the main circuit breaker

2



Make sure that the power is off before continuing with the installation.

2 Install the connected power outlet

1

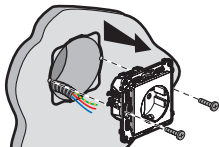

Remove the existing power outlet

3

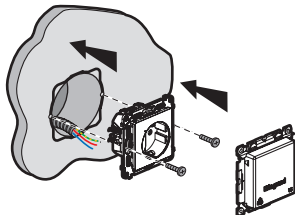

2

Wire the connected power outlet

2.5 mm² rigid wire
(recommended)

**16 A - 230 V~
3680 W max
cos 0.8**

Frequency bands: 2.4 - 2.4835 GHz
Power level: < 100 mW

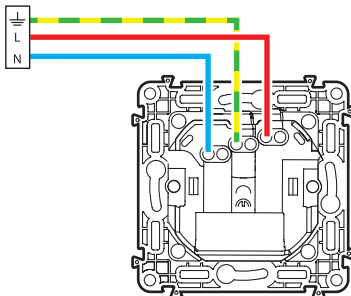

— N (neutral) = blue
— L (live) = any except blue and green/yellow
— \perp (earth) = green/yellow

3 To add a connected product to your connected installation, you should follow the instructions:

- in the **user guide in your connected starter pack**
- in the **Legrand Home + Control application** (Settings/Add a new product section)
- or consult the user manual on **legrand.fr**



www.legrand.fr

LEGRAND - Pro and Consumer Service - BP 30076
87002 LIMOGES CEDEX FRANCE • www.legrand.com

SIMPLIFIED EU DECLARATION OF CONFORMITY

The undersigned,

Legrand

declares that the radio-electric equipment referred to in these instructions complies with directive 2014/53/EU.

The full text of the EU declaration of conformity is available on the following website:

www.legrandoc.com