

	x 18	SXAR18				x 36	SXARC
		x 24	SXAR24					
		x 36	SXAR36					

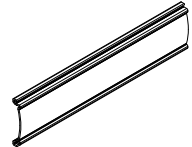

SXAA230

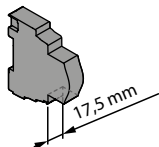

PRI: 95÷250 V~, 50/60 Hz, 150÷75 mA
 NEMO SX: 12 Vd.c., 500 mA

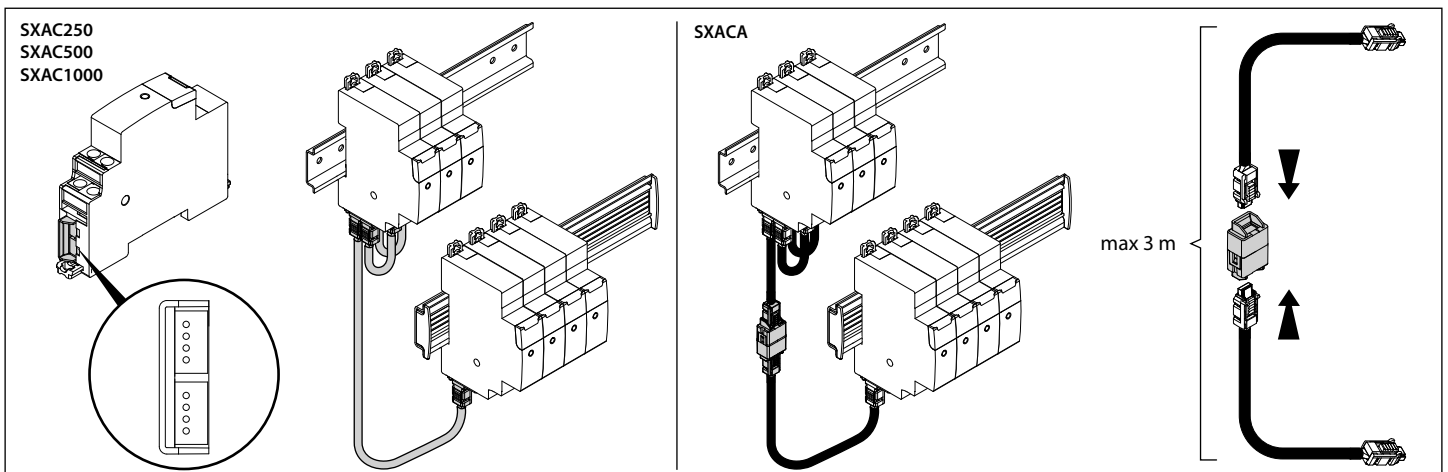
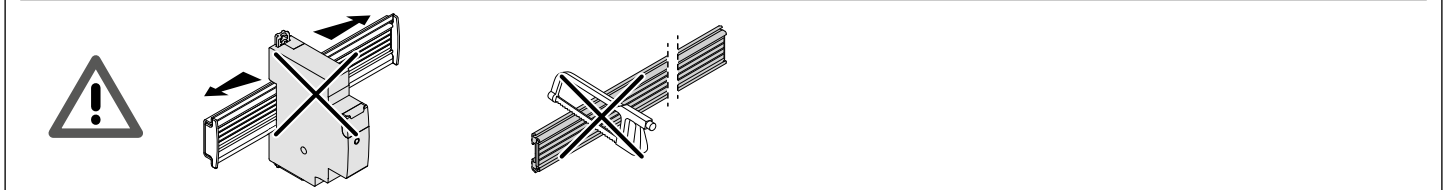
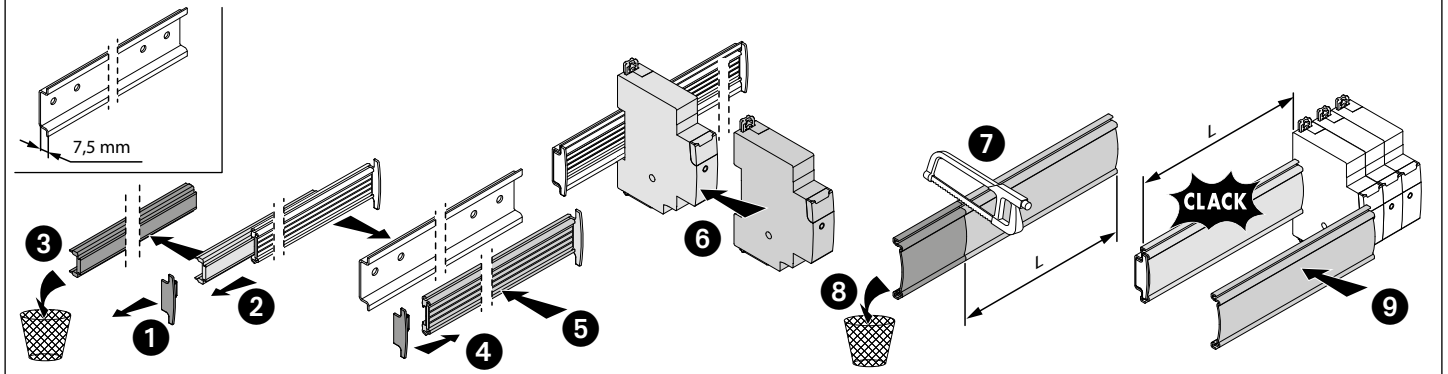
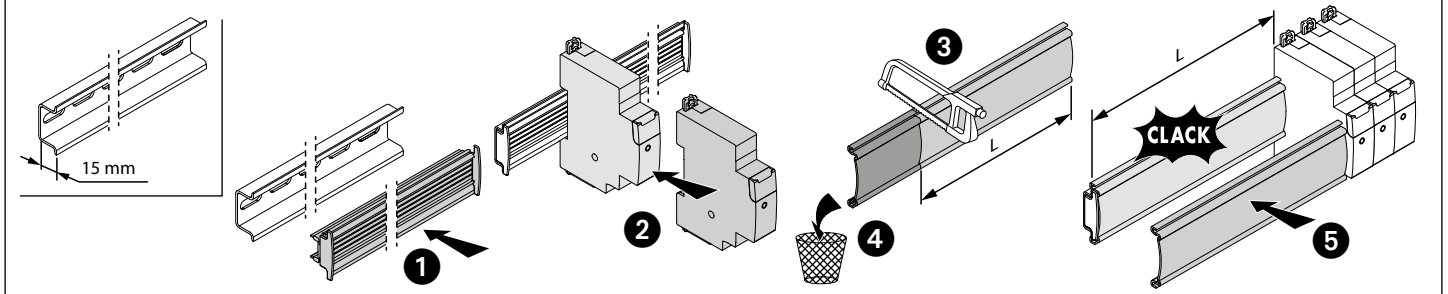
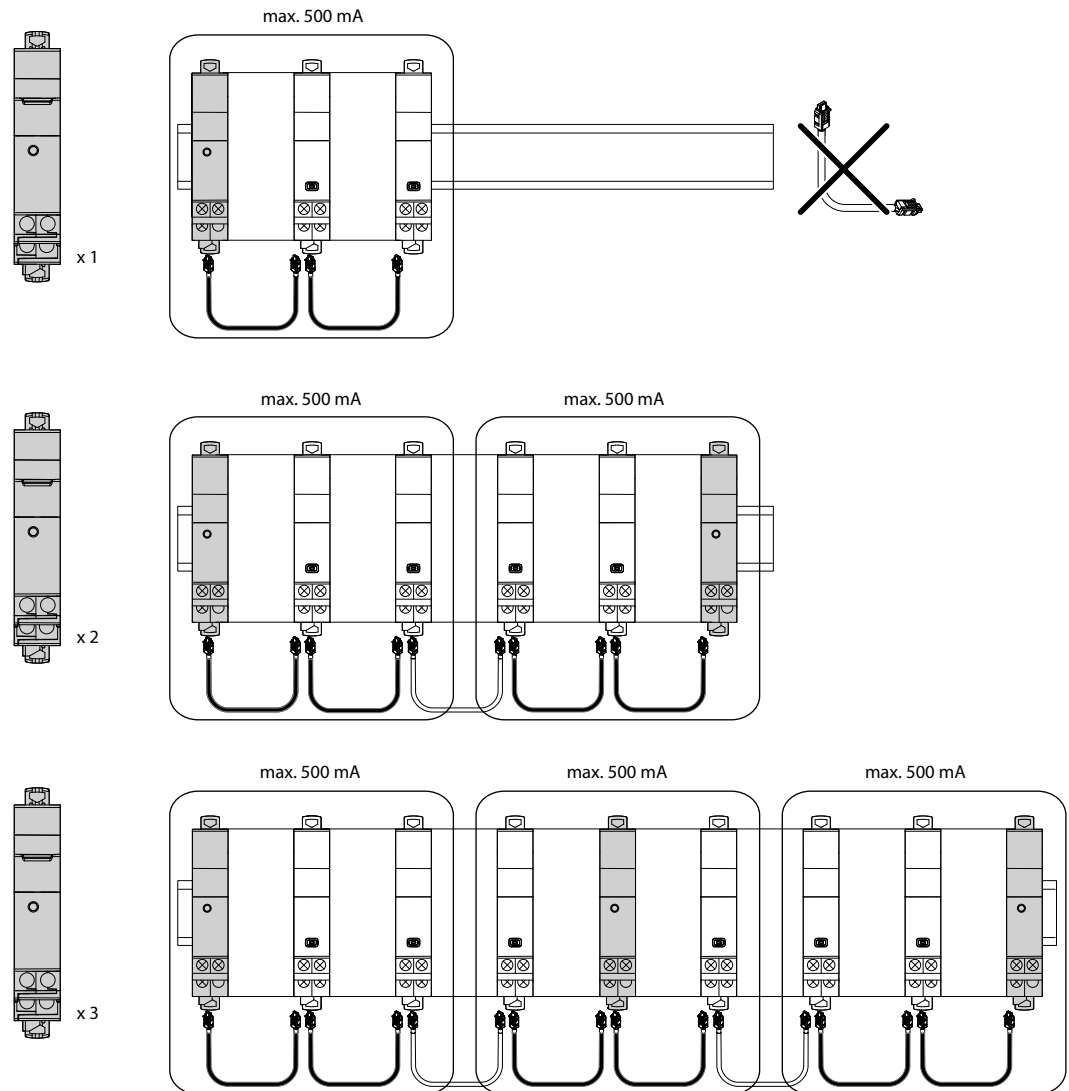
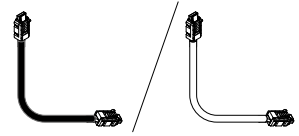
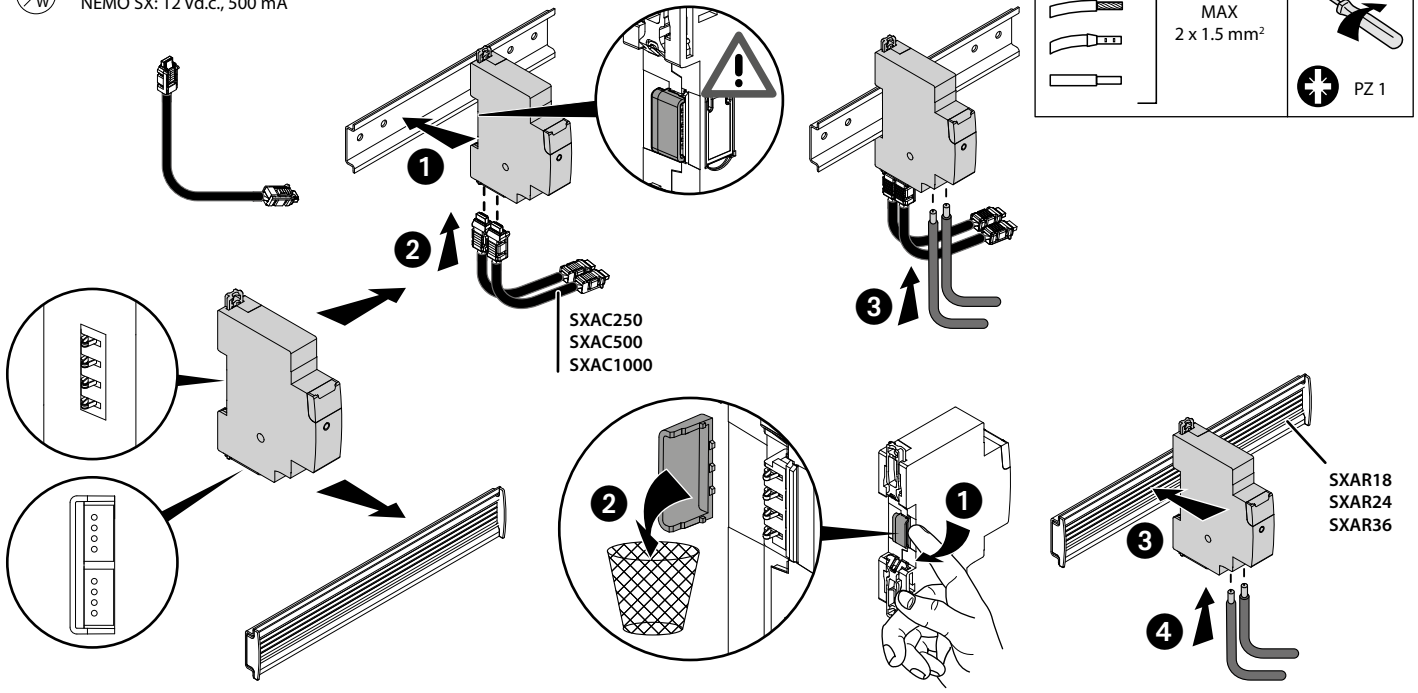

95-250 V~

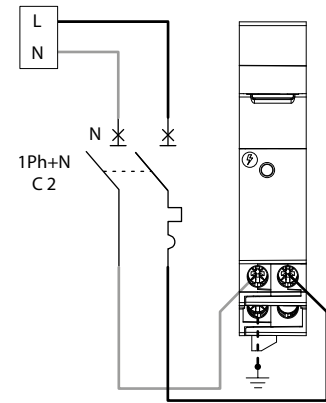

95-250 V~

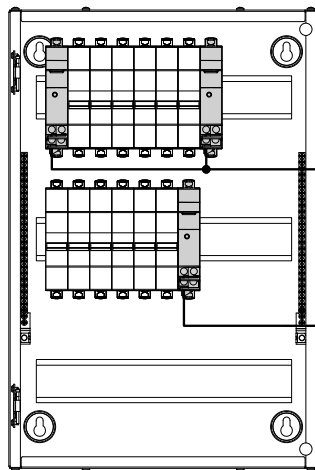
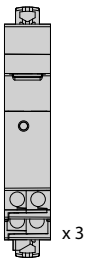
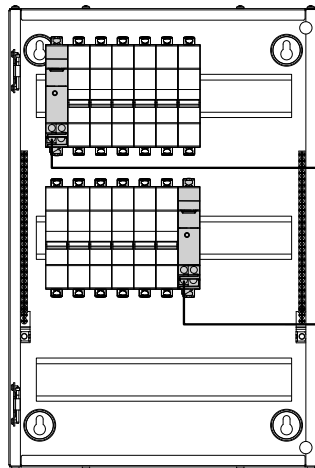
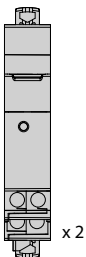
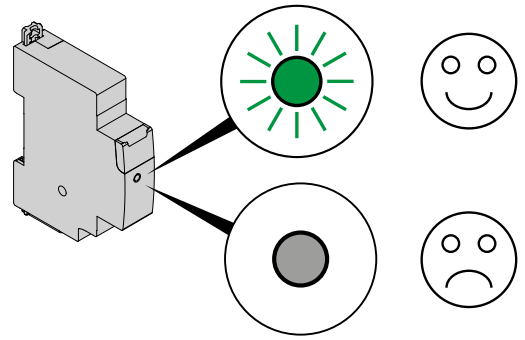
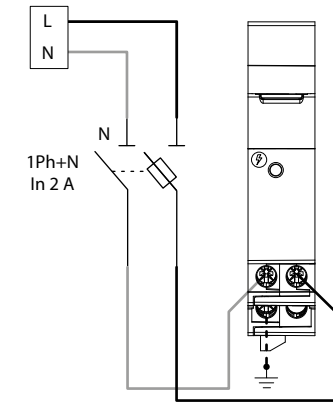

Il non rispetto alla lettera delle condizioni d'installazione e di utilizzo può generare rischi di scariche elettriche o di incendio.

The instructions for installation and use must be strictly observed in order to avoid the risk of electric shock or fire.

Ne pas respecter strictement les conditions d'installation et d'utilisation peut entraîner des risques de choc électrique ou d'incendie.

Bei Nichtbeachtung der Einbau- und Nutzungsvorschriften besteht Stromschlag- bzw. Brandgefahr.

El no cumplimiento estricto de las instrucciones de instalación y uso puede implicar riesgos de choque eléctrico o incendio.

Door de installatie- en gebruiksvoorwaarden niet strikt na te leven, kan er gevaar voor elektrische schokken of brand ontstaan.

Não respeitar estritamente as condições de instalação e de utilização poderá provocar riscos de choque eléctrico ou de incêndio.

Η μη αυστηρή τήρηση των συνθηκών εγκατάστασης και χρήσης μπορεί να επιφέρει κινδύνους ηλεκτροπληξίας ή πυρκαγιάς.

Несоблюдение правил монтажа и эксплуатации может повлечь за собой риск поражения электрическим током или возникновения пожара.

Niezastosowanie się ściśle do warunków instalacji i użytkowania może grozić porażeniem prądem lub pożarem.

Yerleşirme ve kullanım koşullarına uyulmaması elektrik çarpması veya yangın risklerine yol açabilir.

A beszerelési és használati feltételek szigorú betartásának elmulasztása áramütés vagy tűz kockázatával jár.

Jos et noudata tarkasti asennus- ja käyttöohjeita, voit aiheuttaa sähköiskun vaaran tai tulipalon.

IT CH

GB IE

FR LU BE CH

DE AT LI CH

ES

NL BE

PT

GR CY

RU

PL

TR CY

HU

FI

Om installationsvilkoren inte uppfylls strikt, föreligger risk för elchocker eller brand.

Nedodržení stanovených podmínek instalace a používání může vést k rizikům zasažení elektrickým proudem nebo požáru.

V prípade nedodržania presných podmienok týkajúcich sa inštalácie a používania hrozí riziko úrazu elektrickým prúdom alebo vzniku požiaru.

Neupoštevanje vseh pogojev instalacije in uporabe lahko povzroči nevarnost električnega udara ali požara.

Hvis installations- og brugsbetingelserne ikke strengt overholdes, kan det medføre risiko for elektrisk stød eller brand.

Kui paigaldamis- ja kasutustingimusi ei järgita rangelt, võib see kaasa tuua elektrišoki või tulekahjuohtu.

Precizni neievėrojot uzstādīšanas un lietošanas noteikumos, pieaug elektriskās strāvas trieciena vai ugunsgrēka iespējamība.

Tiksliai nesilaikant instaliavimo ir naudojimo sąlygų gali kilti trumpojo elektros jungimo arba gaisro pavojus.

Manglende overhold av installasjons- og brugsbetingelsene kan føre til elektrisk stød eller brann.

Ef skilyrðum um uppsetningu og notkun er ekki vandlega fylgt kann slíkt að valda hættu á raflosti eða eldsvoða.

Nerespectarea strictă a condițiilor de instalare și utilizare poate genera riscuri de șocuri electrice sau incendiu.

Неспазването стриктно на указанията за съгласяване и използване може да доведе до риск от токов удар или пожар.

SE

CZ

SK

SI

DK

EE

LV

LT

NO

IS

RO

BG