

1

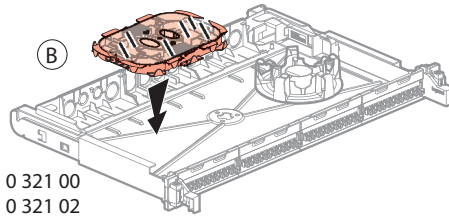

0 321 00
0 321 02
0 321 04
0 321 06

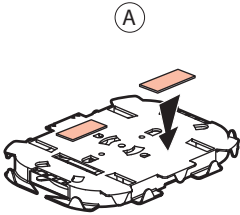
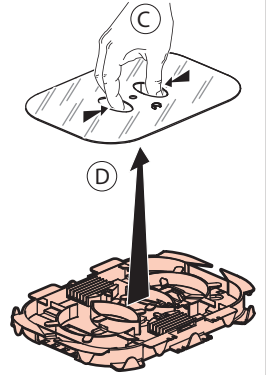

2

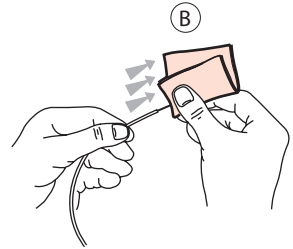
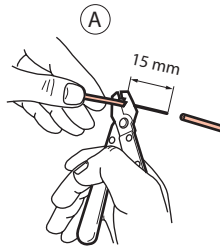
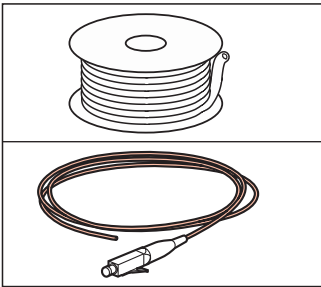

3

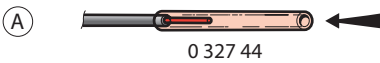

FLASH

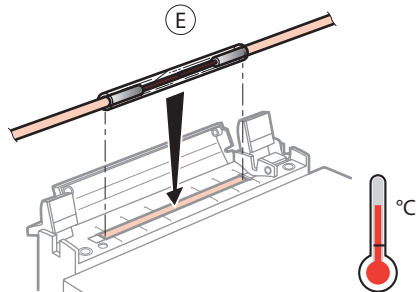
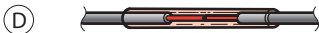

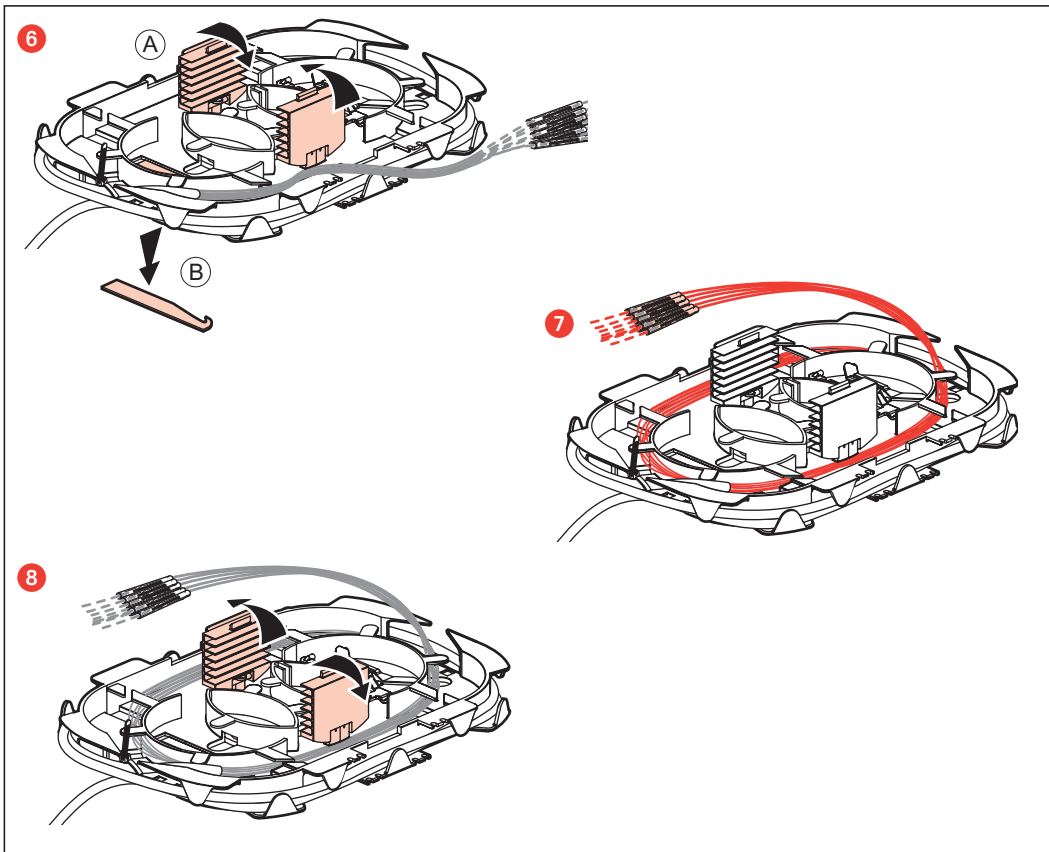
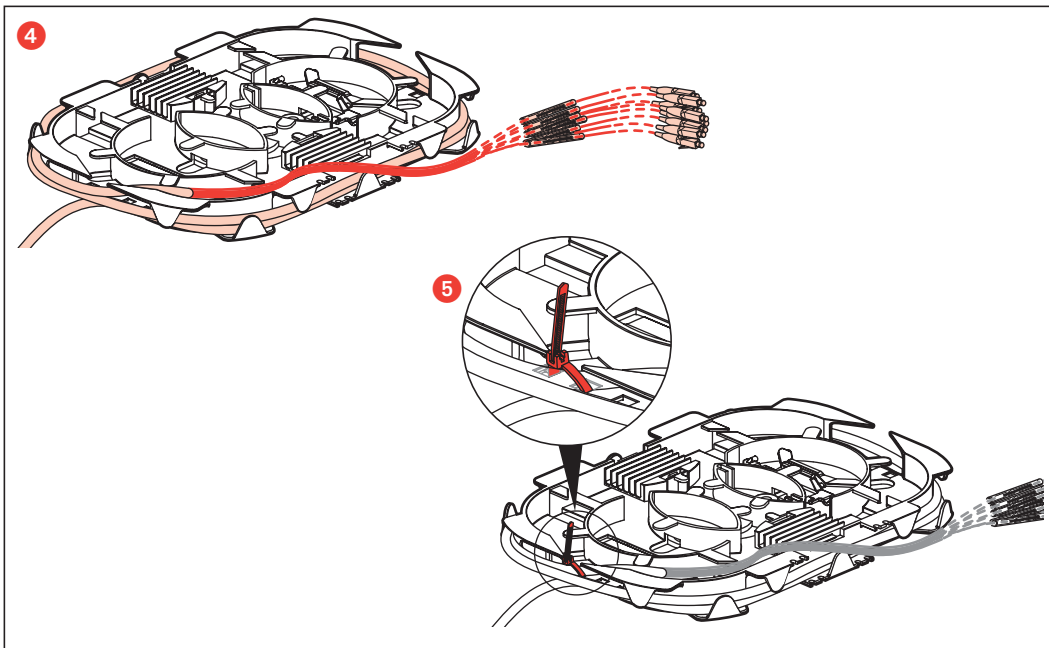

9

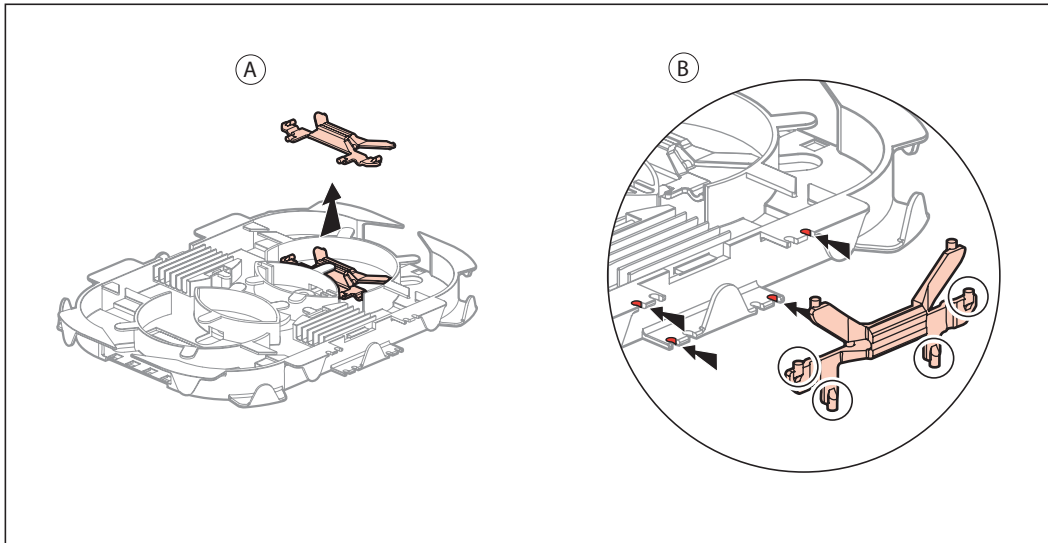
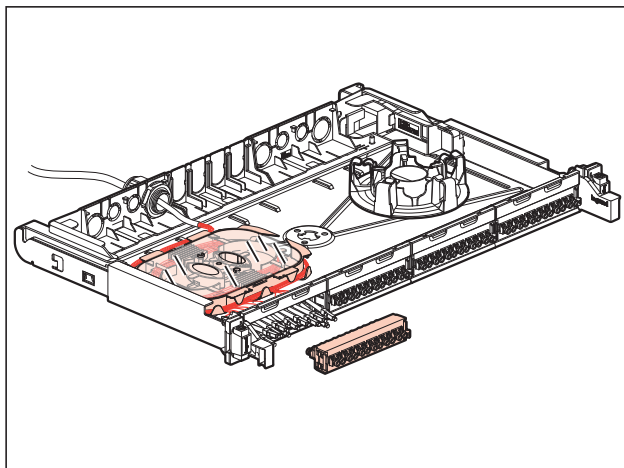
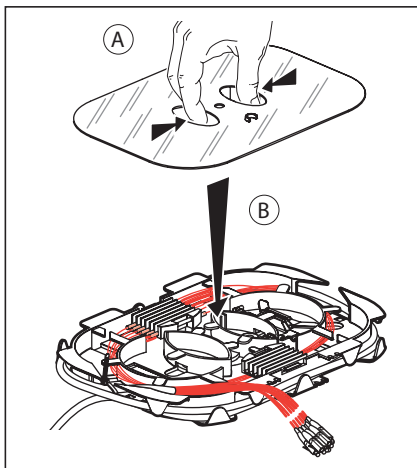
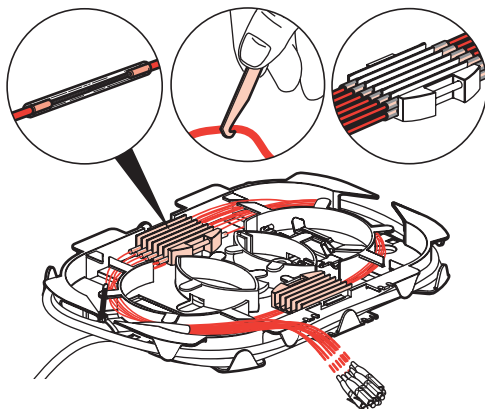

C

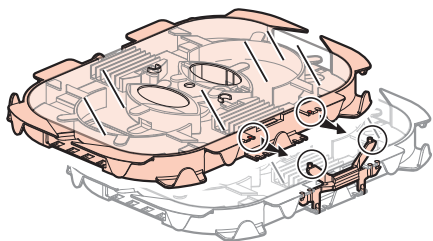

D

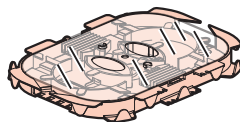
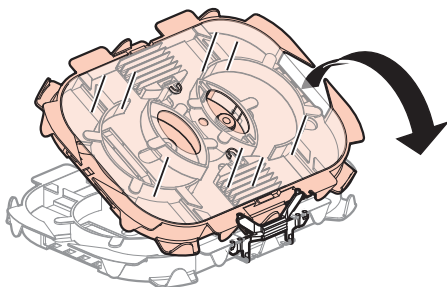
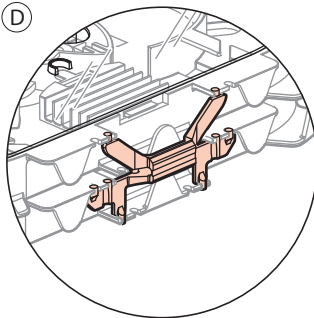

24

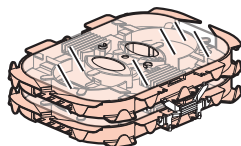

48

⚠ Consignes de sécurité

FR LU BE CH

Avant toute intervention, couper le courant.
Respecter strictement les conditions d'installation et d'utilisation.

⚠ Veiligheidsvoorschriften

NL BE

Onderbreek voor enige ingreep de stroom.
Neem de installatie- en gebruiksvoorwaarden nauwgezet in acht.

⚠ Safety instructions

GB IE

Make sure the power supply is disconnected before any intervention.
Strictly comply with instructions for installation and use.

⚠ Sicherheitshinweise

DE CH

Vor jeglichem Eingriff die Spannungsfreiheit sicherstellen.
Einbau- und Gebrauchsanleitungen sind genau zu beachten.

⚠ Consignas de seguridad

ES

Antes de realizar cualquier intervención, cortar la corriente eléctrica.
Respetar estrictamente las condiciones de instalación y uso.

⚠ Instruções de segurança

PT

Antes de qualquer intervenção, desligar a corrente.
Respeitar rigorosamente as condições de instalação e de utilização.

⚠ Συστάσεις ασφαλείας

GR CY

Πριν από οποιαδήποτε επέμβαση, διακόψτε την παροχή ρεύματος.
Να τηρείτε ανστηρά τις συνθήκες εγκατάστασης και χρήσης.

⚠ Меры предосторожности

RU

Отключить питание перед проведением любых ремонтных работ.
Строго соблюдайте требования к условиям монтажа и эксплуатации.

⚠ Istruzioni di sicurezza

IT CH

Prima di qualsiasi intervento, interrompere l'alimentazione.
Rispettare scrupolosamente le condizioni d'installazione e uso.

⚠ 安全提示

在任何干涉以前一定要断电，严格遵守安全和使用的规定。

إرشادات الأمان: ⚠

«إفطع التيار الكهربائي قبل أي تدخل. نقيده نقيداً تماماً بشروط التركيب والاستخدام.»