

-10°C ... +70°C	-5°C ... +35°C	40 mm	10 / 13 mm 1...2,5...4 mm²

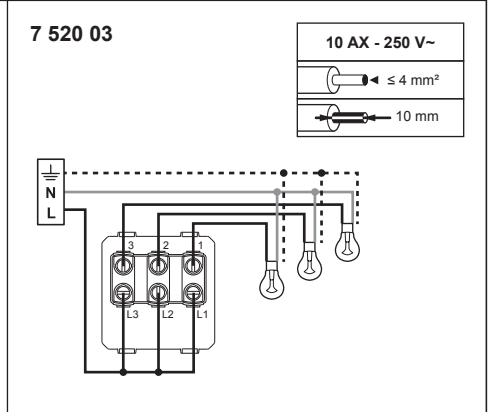

<p>7 520 05</p> <p>10 AX - 250 V~</p> <p>≤ 2,5 mm²</p> <p>13 mm</p>	<p>7 520 05 + 0 676 84</p> <p>10 AX - 250 V~</p> <p>≤ 2,5 mm²</p> <p>13 mm</p>	<p>7 520 06 / 16 (10 AX) 7 520 27 (16 AX)</p> <p>10 AX / 16 AX - 250 V~</p> <p>≤ 2,5 mm²</p> <p>13 mm</p>
<p>7 520 06 / 16 (10 AX) 7 520 27 (16 AX) + 0 676 86</p> <p>10 AX / 16 AX - 250 V~</p> <p>≤ 2,5 mm²</p> <p>13 mm</p>	<p>7 520 06 / 16 (10 AX) 7 520 27 (16 AX) + 7 520 57</p> <p>10 AX / 16 AX - 250 V~</p> <p>≤ 2,5 mm²</p> <p>13 mm</p>	<p>7 520 06 / 16 (10 AX) 7 520 27 (16 AX) + 6 650 90</p> <p>10 AX / 16 AX - 250 V~</p> <p>≤ 2,5 mm²</p> <p>13 mm</p>
<p>7 520 07</p> <p>10 AX - 250 V~</p> <p>≤ 2,5 mm²</p> <p>10 mm</p>	<p>7 520 07 + 6 650 90</p> <p>10 AX - 250 V~</p> <p>≤ 2,5 mm²</p> <p>10 mm</p>	<p>7 520 08 / 28</p> <p>10 AX - 250 V~</p> <p>≤ 2,5 mm²</p> <p>13 mm</p>
<p>7 520 08 / 28 + 0 676 86</p> <p>10 AX - 250 V~</p> <p>≤ 2,5 mm²</p> <p>13 mm</p>	<p>7 520 08 / 28 + 7 520 57</p> <p>10 AX - 250 V~</p> <p>≤ 2,5 mm²</p> <p>13 mm</p>	<p>7 520 08 / 28 + 6 650 90</p> <p>10 AX - 250 V~</p> <p>≤ 2,5 mm²</p> <p>13 mm</p>
<p>7 520 10</p> <p>10 AX - 250 V~</p> <p>≤ 2,5 mm²</p> <p>13 mm</p>	<p>7 520 10 + 7 520 58</p> <p>10 AX - 250 V~</p> <p>≤ 2,5 mm²</p> <p>13 mm</p>	<p>7 520 10 + 0 676 88</p> <p>10 AX - 250 V~</p> <p>≤ 2,5 mm²</p> <p>13 mm</p>

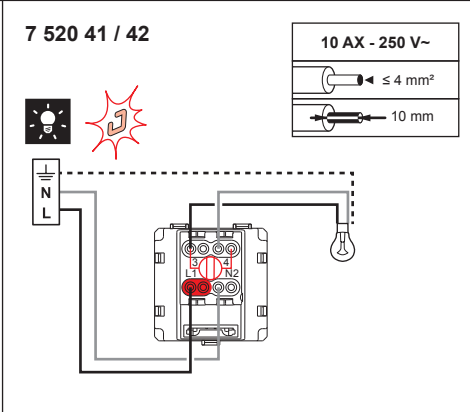

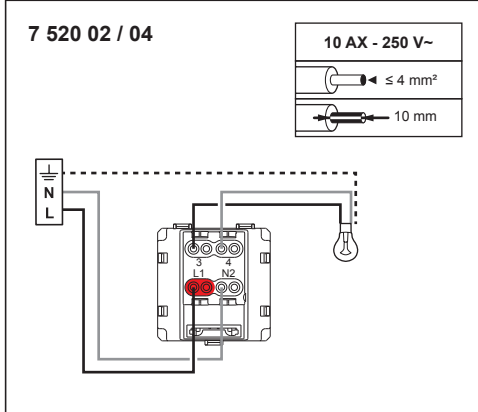
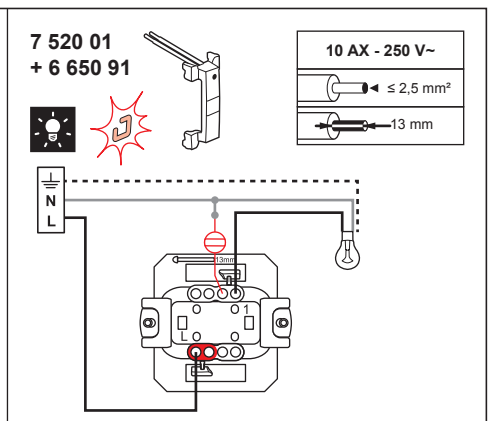
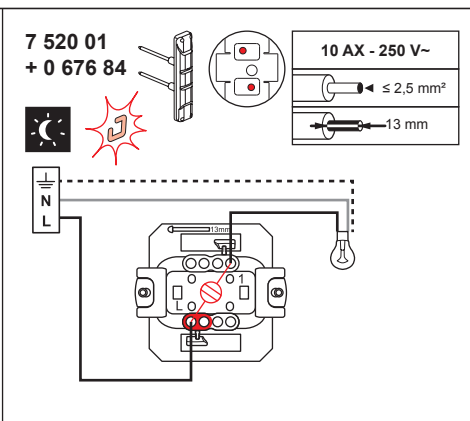
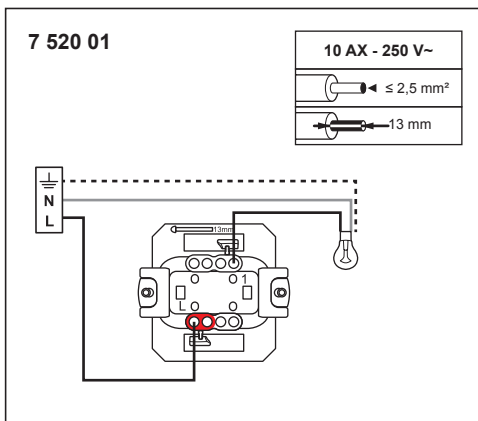
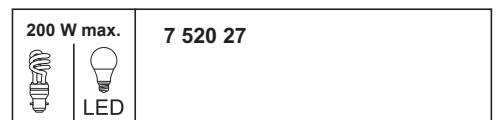
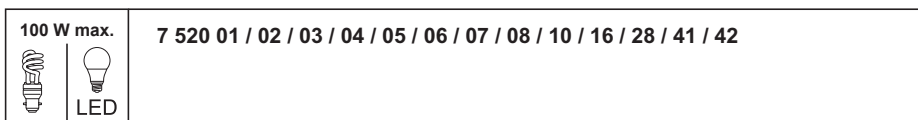
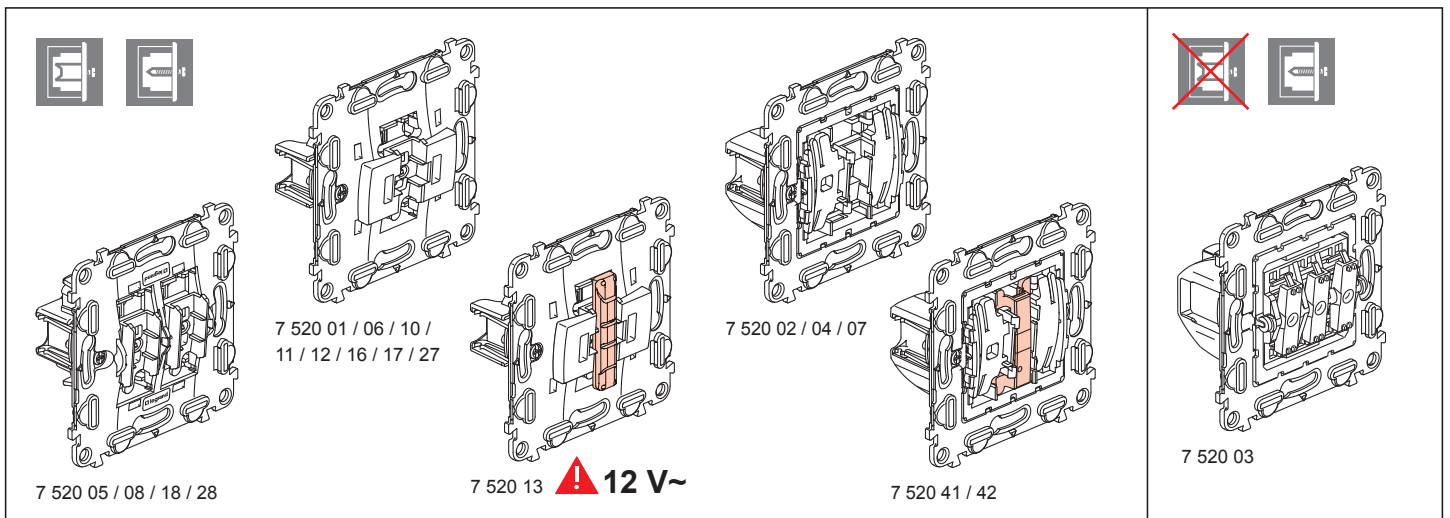
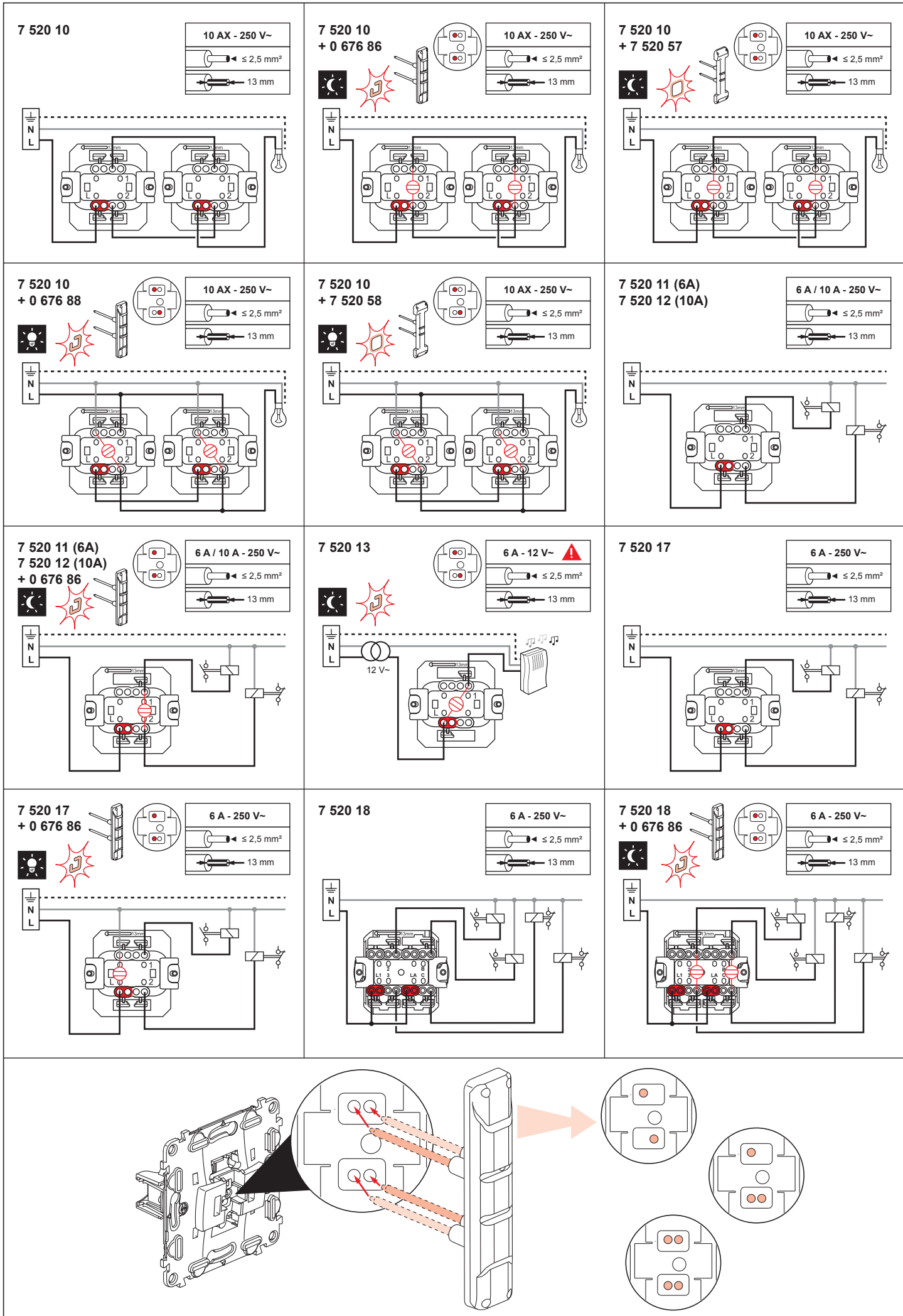

12 - 48 V~ ~~250 V~~~

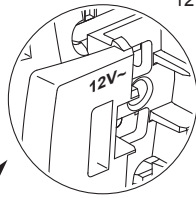
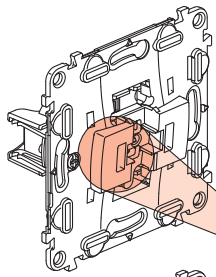

12 - 48 V~

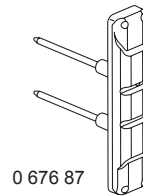

0 676 87

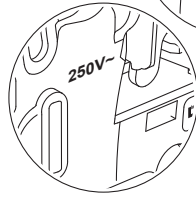
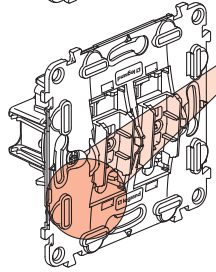

250 V~

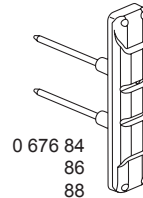
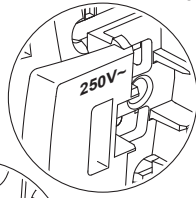

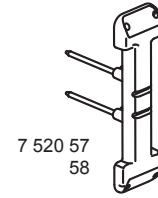

0 676 84
86
88

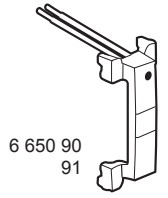

7 520 57
58



6 650 90
91

	0 676 84	0 676 86	0 676 87	0 676 88	6 650 90	6 650 91	7 520 57	7 520 58
7 520 01	✓	—	—	—	—	✓	—	—
7 520 02	—	—	—	—	—	—	—	—
7 520 03	—	—	—	—	—	—	—	—
7 520 05	✓	—	—	—	—	—	—	—
7 520 06 / 16 / 27	—	✓	—	—	 ✓	—	✓	—
7 520 07	—	—	—	—	✓	—	—	—
7 520 08 / 28	—	✓	—	—	 ✓	—	✓	—
7 520 10	—	✓	—	✓	—	—	✓	✓
7 520 11 / 12	—	✓	—	—	—	—	—	—
7 520 13	—	—	✓	—	—	—	—	—
7 520 17	—	✓	—	—	—	—	—	—
7 520 18	—	✓	—	—	—	—	—	—
7 520 41	—	—	—	—	—	✓	—	—