









	29 V _~
	20 mA
	4 x (Ø 0,6 mm <  < Ø 0,8 mm)
	-5°C → +45°C
	 PIR
	150 lux
	15 mn
	Auto ON/OFF
	Ø 5 m
	15 m









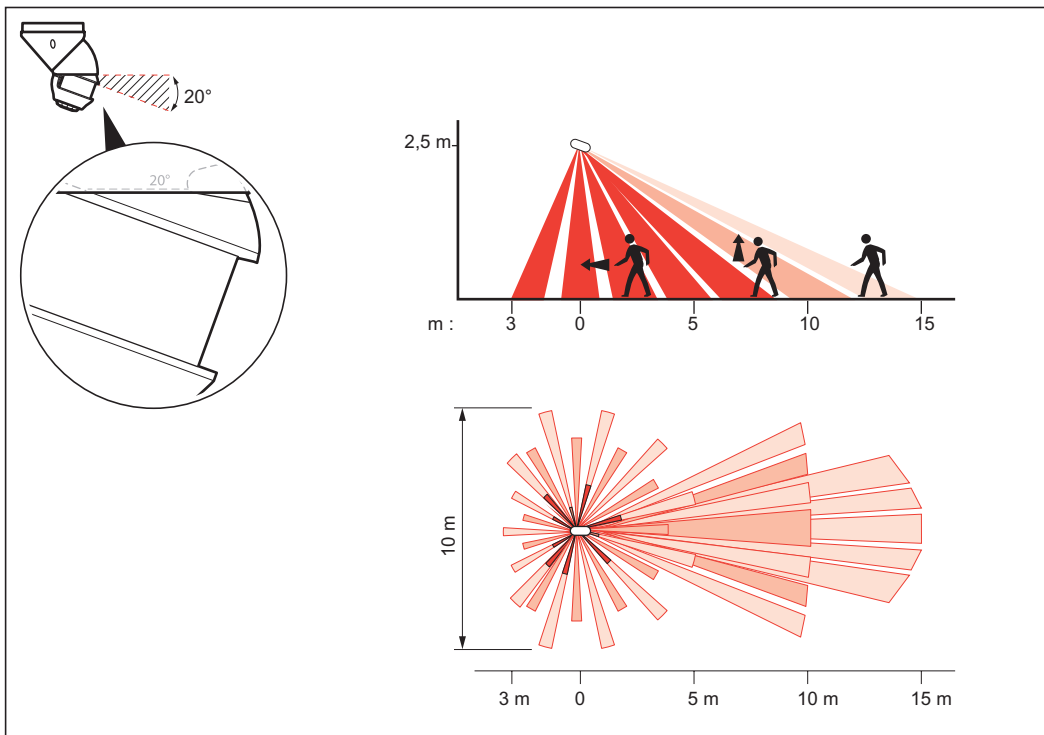
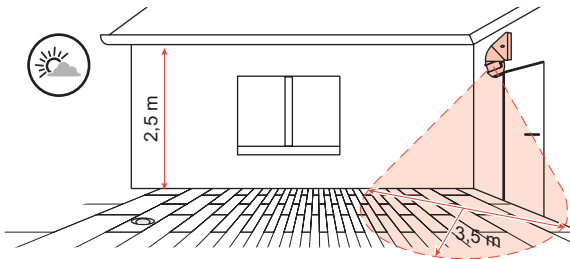
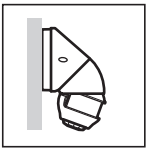
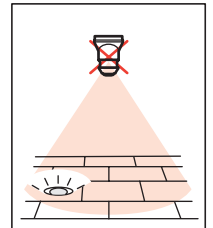
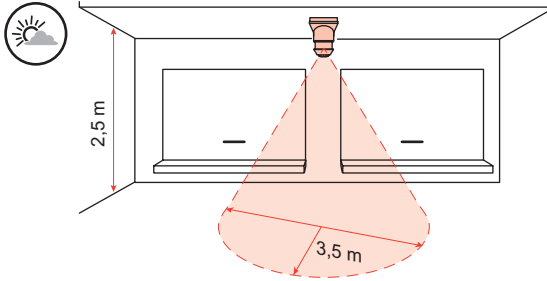
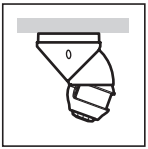
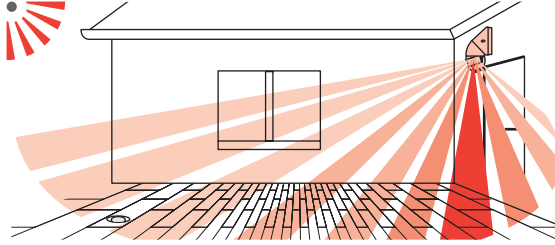
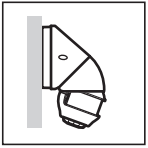
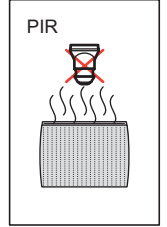
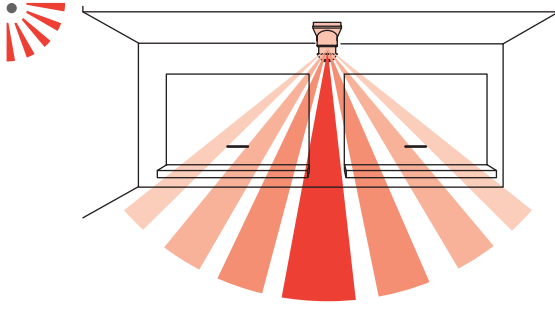
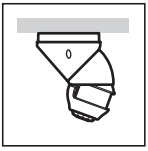
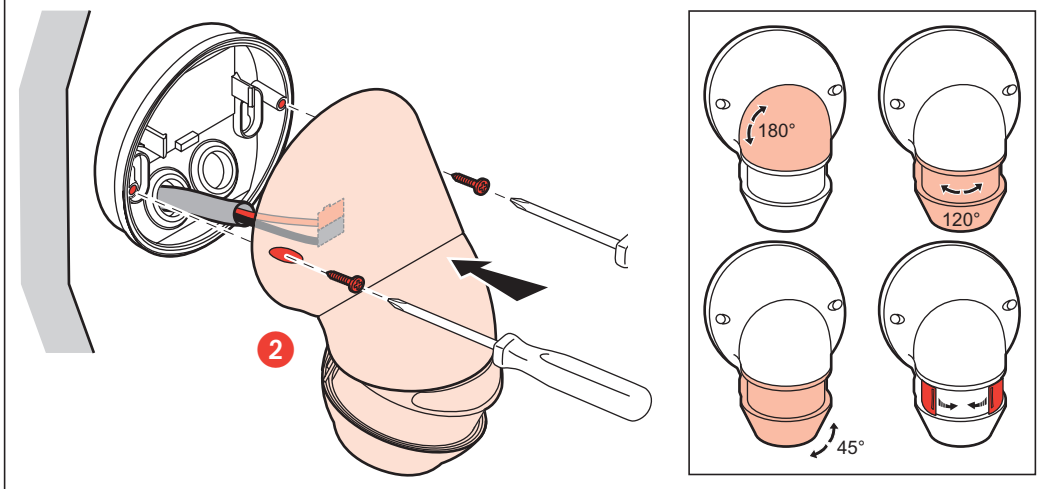
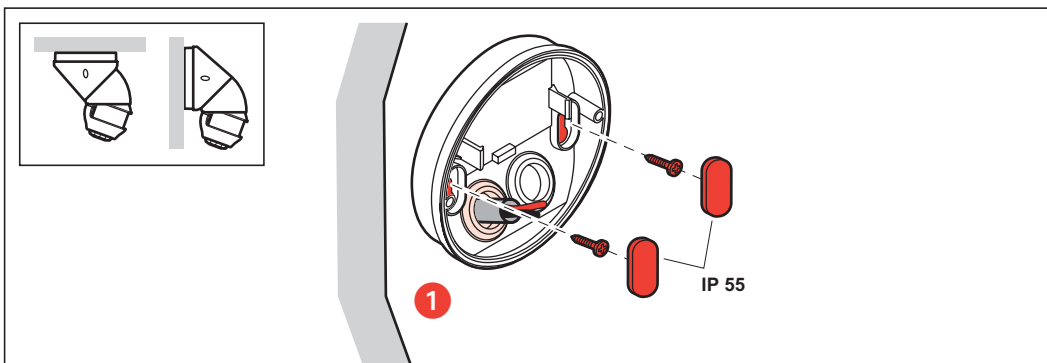
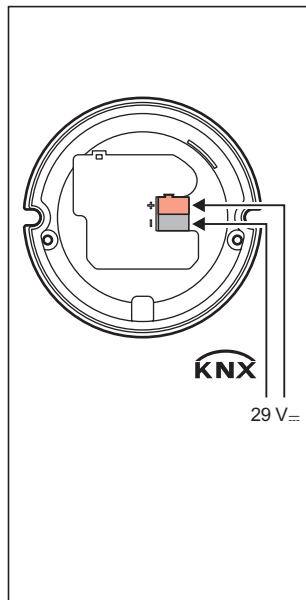
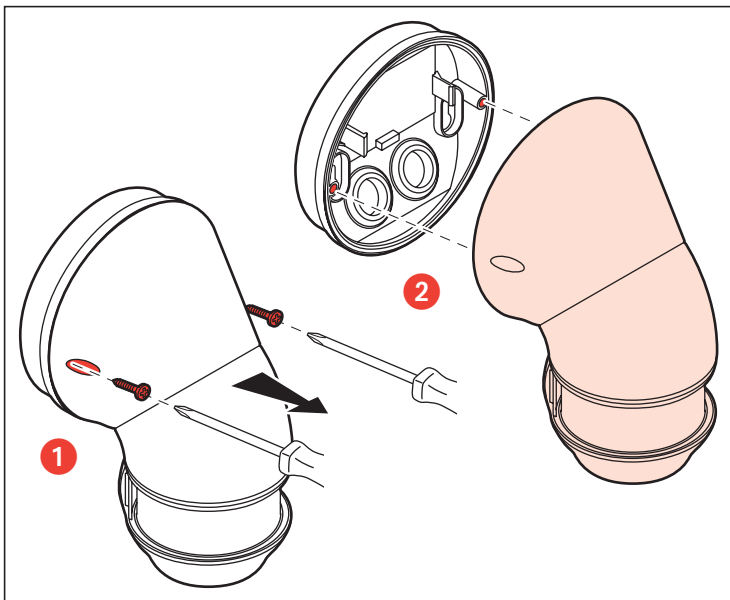
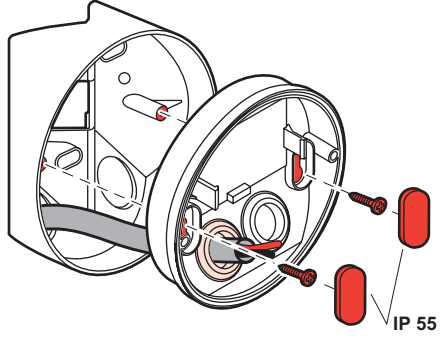
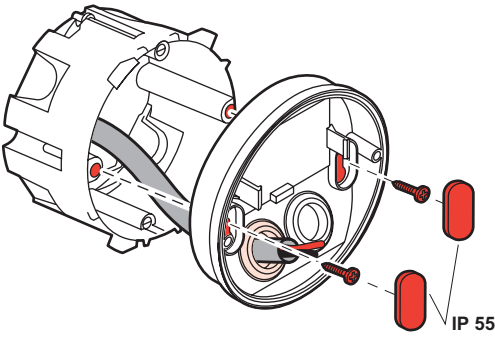
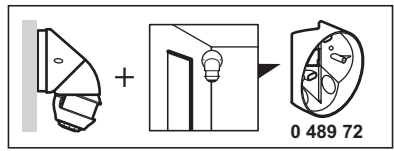
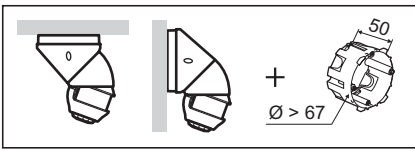

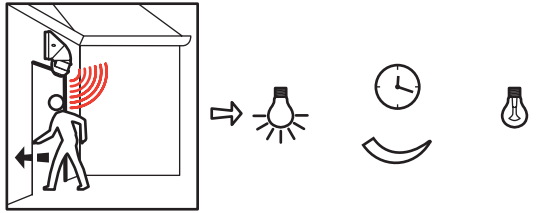
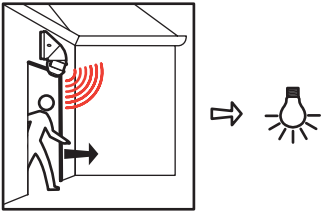
 **Auto ON/OFF**



 **Manual ON / Auto OFF**

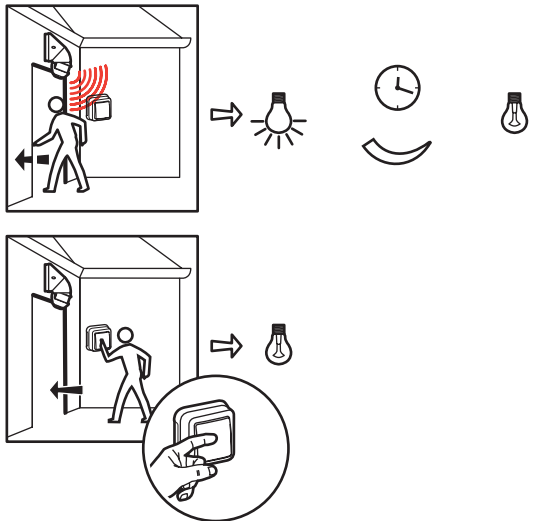
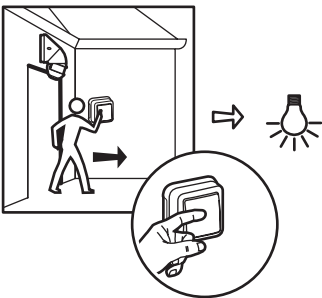



	5 - 1275 lux
	5 sec - 18h00
	25% - 50% - 75% - 100%
Mode	Auto ON/OFF - Manual On/Auto OFF - Walkthrough

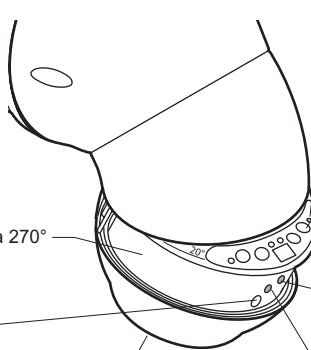

- Détecteur/capteur PIR 180° à 270°
- PIR sensor 180° to 270°
- Sensore PIR 180° a 270°
- Cellule de luminosité
- Daylight sensor
- Cellula di luminosità
- Détecteur/capteur PIR 360°
- PIR sensor 360°
- Sensore PIR 360°

- LED KNX
- KNX LED
- LED KNX

- Bouton de prog. KNX
- KNX prog. push-button
- Pulsante prog. KNX

- LED de détection
- Motion led
- LED rilevazione movimento

- LED d'émission/de réception IR
- IR reception/transmission LED
- LED ricezione/trasmissione IR



* 0 882 30
BMSO4001

- * • Version minimum du firmware **2.5.6**, mise à jour disponible sur www.legrandoc.com
- Minimum version of **2.5.6** firmware update available on www.legrandoc.com
- Versione minima del firmware **2.5.6**, software di aggiornamento disponibile su www.legrandoc.com

