

Prise HD15

Prise HD15 + jack

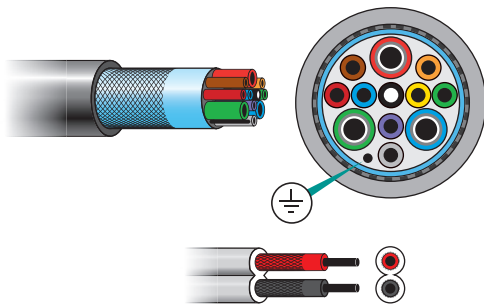

1

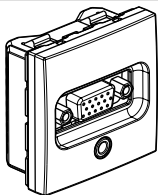
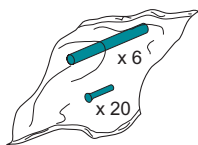
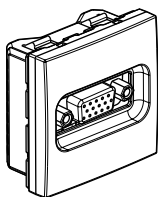
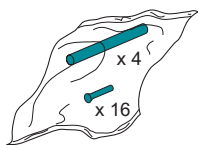
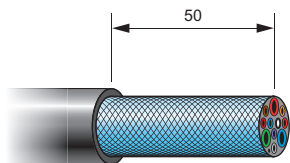

2

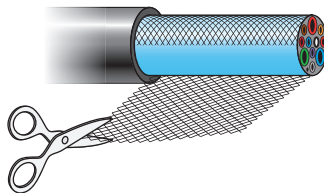

3

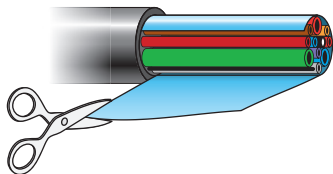

4

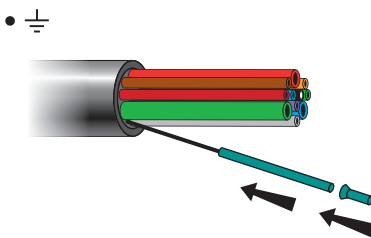

5

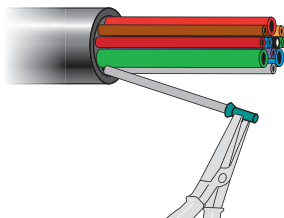

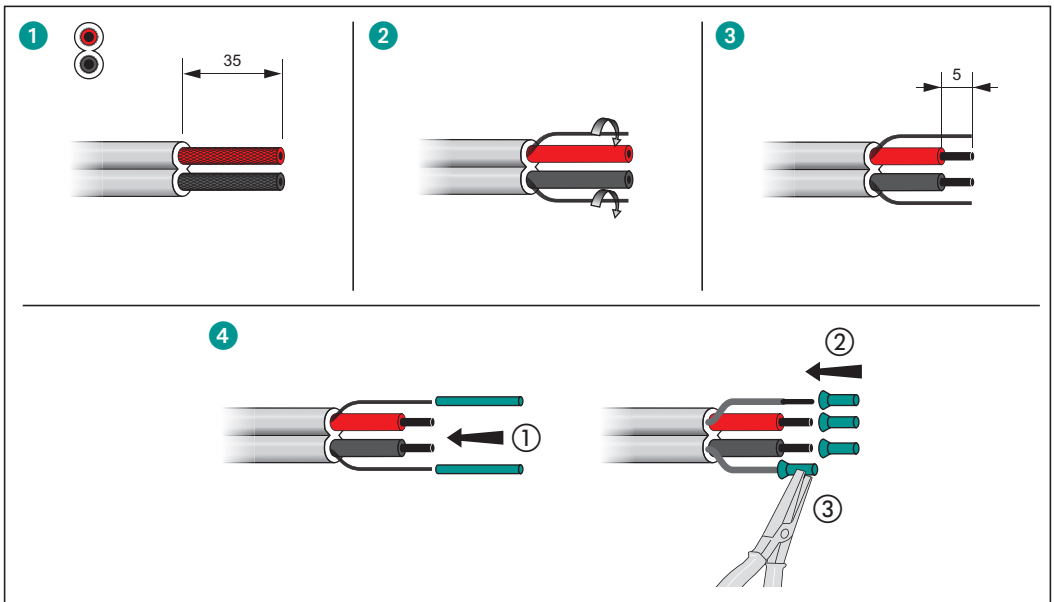
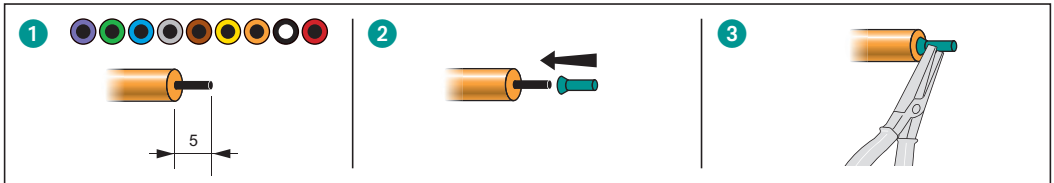
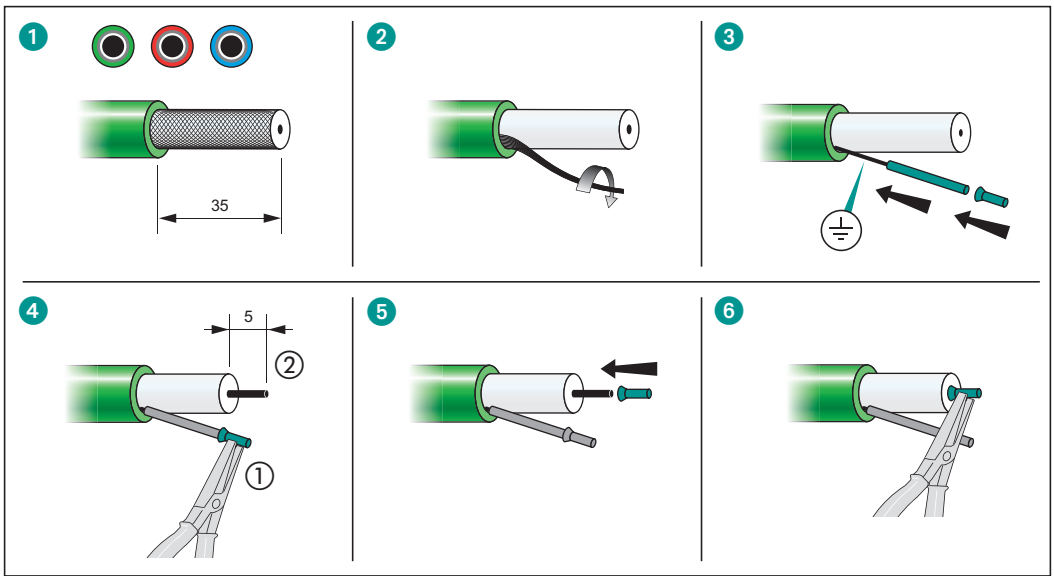

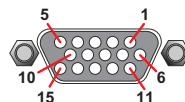
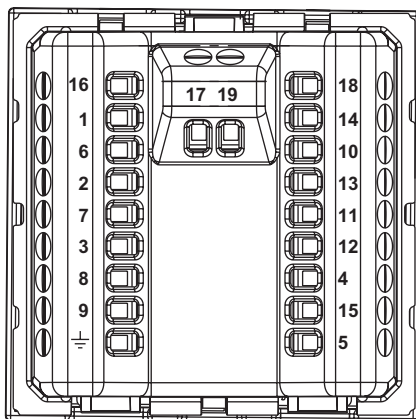

















Repère bornier (Repère connecteur)

VGA FULL PIN

-  { 1 Coax rouge (rouge)
-  { 6 Tresse rouge(masse rouge)
-  { 2 Coax vert (vert)
-  { 7 Tresse verte (masse verte)
-  { 3 Coax bleu (bleu)
-  { 8 Tresse bleue (masse bleue)
-  9 Violet
-  14 Vert (SV)
-  10 Bleu (masse SH-SV)
-  13 Gris (SH)
-  11 Marron (ID Bit 0)
-  12 Jaune (ID Bit 1)
-  4 Orange (ID Bit 2)
-  15 Noir (ID Bit 3)
-  5 Rouge (Gnd)
-  Masse générale

VGA RVB SH SV

- 1 Coax rouge (rouge)
- 6 Tresse rouge (masse rouge)
- 2 Coax vert (vert)
- 7 Tresse verte (masse verte)
- 3 Coax bleu (bleu)
- 8 Tresse bleue (masse bleue)
- 14 Vert (SV)
- 10 Bleu (masse SH-SV)
- 13 Gris (SH)
- ⊥ Masse générale

Jack

- 16 HP droit
- 17 Masse HP droit
- 18 HP gauche
- 19 Masse HP gauche

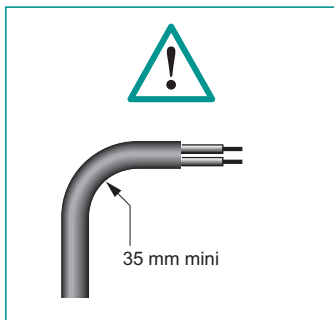

Consignes de sécurité

Ce produit doit être installé de préférence par un électricien qualifié. Une installation et une utilisation incorrectes peuvent entraîner des risques de choc électrique ou d'incendie.

Avant d'effectuer l'installation, lire la notice, tenir compte du lieu de montage spécifique au produit.

Ne pas ouvrir l'appareil. Tous les produits PLANET WATTOHM doivent exclusivement être ouverts et réparés par du personnel formé et habilité par PLANET WATTOHM. Toute ouverture ou réparation non autorisée annule l'intégralité des responsabilités, droits à remplacement et garanties. Utiliser exclusivement les accessoires d'origine.