

LCS 3

TECHNICAL DATA SHEET SERVER CABINET

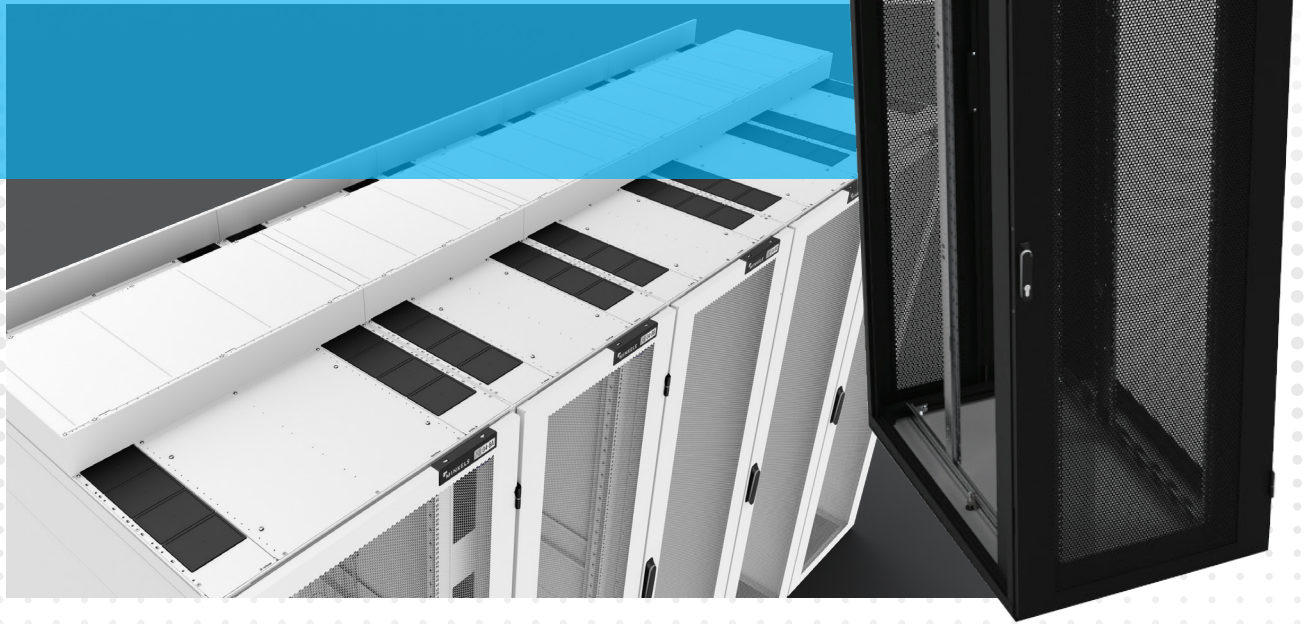

DATA CENTER
LOCAL AREA NETWORK

THE GLOBAL SPECIALIST
IN ELECTRICAL AND DIGITAL BUILDING INFRASTRUCTURES

 **legrand**[®]

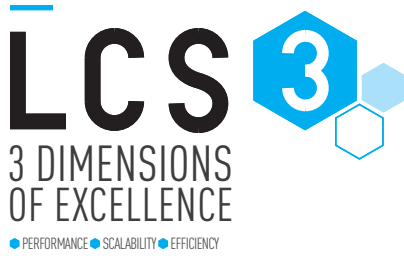

The **LCS3 server cabinets** are perfectly suited for the installation of (blade) servers, switches, patch panels, routers and storage equipment. The cabinets are used to bring together IT equipment and the corresponding cables neatly in one place. The server cabinets have everything to facilitate this in the best energy efficient and modular way. The cabinets are widely applicable and modular in structure. What type of cabinet is most suitable depends highly on its application. The server cabinets can be configured in varying heights, widths and depths.

BENEFITS OF SERVER CABINETS

- Premium quality cabinet system for on-premise, colocation and hyperscale datacenters
- Demountable aluminum frame for reduced weight at maximum strength
- Superb for (High Density) servers, storage and network equipment
- Highly energy efficient due to best in class airflow management
- Accessories compatible between server and cabling cabinets



GENERAL FEATURES		
General:		
		Server cabinets delivered without side panels Server cabinets with airflow management are supplied with an airflow management package keeping the loss of air to a minimum, thus improving energy efficiency Server cabinets with airflow management are supplied with side skirt with cutouts and panels. all the cabinets are equipped with leveling feet
Colour		RAL 9005 (black)
Static load capacity	kg	1500
Earthing		Fully earthed with central earthing point
IP grade		IP20
Dimensions:		
Height	U	42 or 47
Height	mm	1978 or 2200
Width	mm	600 or 800
Depth	mm	1000 or 1200
Interior:		
19-inch profiles	pcs	4 • steel, powder coated
Adjustability (depth)		Stepless adjustability with depth marking
Adjustability (width)		Stepless adjustability
U marking		1st U at bottom
Distance to the cabinet with airflow front		Set to 80 mm (pitch set to 100 mm)
Distance to the cabinet front		Set to 175 mm (pitch set to 100 mm)
Frame:		
Material		Aluminium extrusions
Finishing		Powder coated
Front/rear closure:		
Front door		80% perforated <u>single</u> front door
Rear door		80% perforated <u>double</u> rear door
Security		2-Points Fix-Easy swivel handle with an EK-333 cylinder lock
Material		Steel
Finishing		Powder coated
Hinges		Easily reversable and fast placement • Max. rotation degree 260°
Roof:		
Modularity		Modular inserts per 100 mm
Inserts:		3 Cut outs: the left and right has blind plates and brushes. The center cut out has a blind plate.



The **LCS3 server cabinets** are available in various types. **A standard version or a version with airflow package.**

AIRFLOW MANAGEMENT

Airflow management is the efficient guidance of the various airflows in data centers to keep the cold and hot air separated optimally. To optimize that cooling process, air leakage and recirculation must be minimized by using an airflow management package. Airflow management packages consist of a plate on the bottom, top, left and right. The airflow management package enables an air tight adjustability in the depth direction of 150 mm.

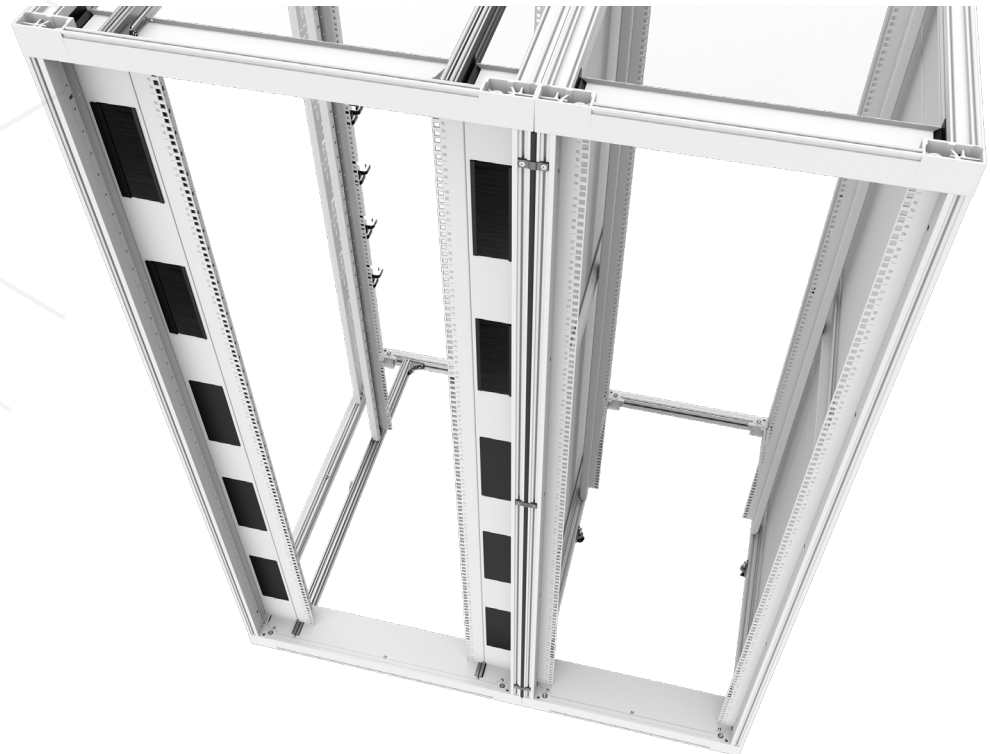

LCS3 19" server cabinets

General features



FRAME

- Light but sturdy aluminium frame with a maximum static load capacity of 1500 kg.
- Offers a unique degree of flexibility: the unit is continuously adjustable in all three dimensions.
- Rails adjustable with screws to allow continuously variable depth, width and height (e.g. for cable management).
- Integrated T-slots allow continuously variable depth and height adjustment (e.g. adjustable vertical rail with screws).
- Upgrade the energy efficiency with an airflow package. (To be added at a later stage.)
- Easy to install because all the accessories and components are accessible from inside the cabinet.
- Vertical cable managers with PDU mounting capabilities.

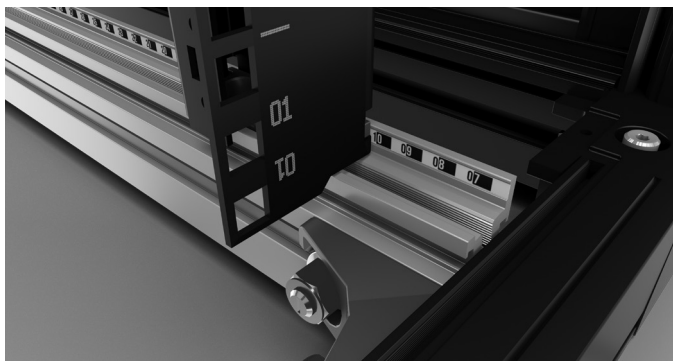

Depth marking placed on depth profiles
 Stepless adjustability in depth direction





TOP

- A solid platform for installing top-of-cabinet infrastructure.
- Cut-aways as wide as possible, left and right.
- Optimum accessibility for cabling.
- Optimum positioning for PDUs – suitable for plugs of up to 32A.
- Cable strain relief available.
- Roof panels in multiples of 100 mm.

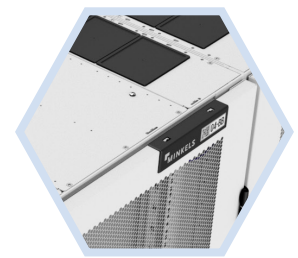
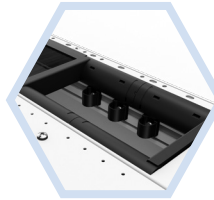
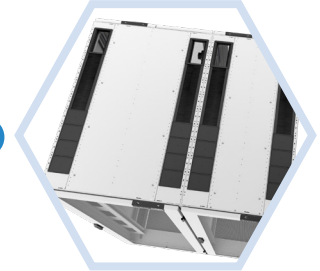

80% PERFORATED DOOR

- Single front door and split back door with Fix Easy locking.
- Predefined position for identification. (Place serial numbers, barcodes or QR codes here to encode and personalise your cabinets.)
- Clean, minimalist design.
- The door is simple to fit.
- Suitable for various types of locks.
- Door can easily be switched round (opening from the left or right).
- Door opens to 165° when cabinets are connected together.
- Door opens to 260° when cabinets are stand-alone.
- Complete integration of the locking mechanism and the cabling (when intelligent locks are used).

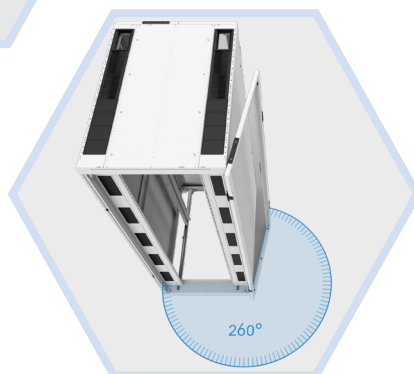
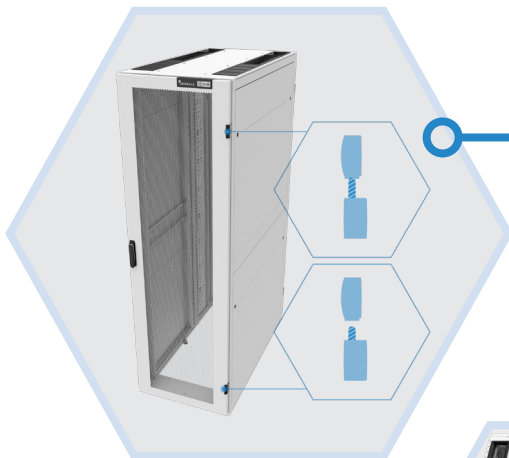

Standard server cabinets

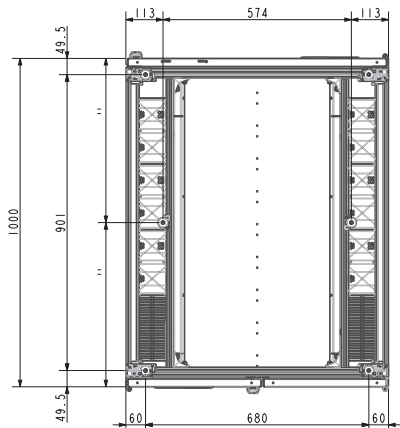
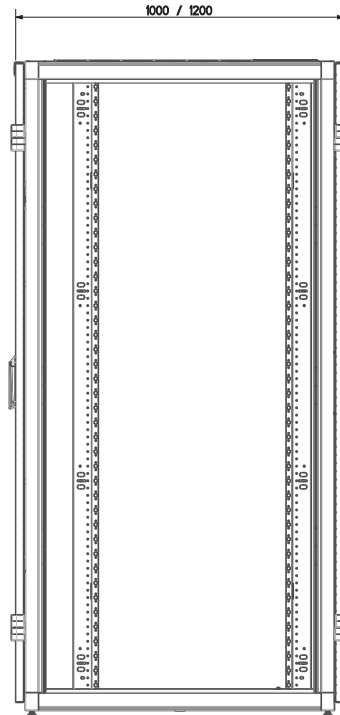
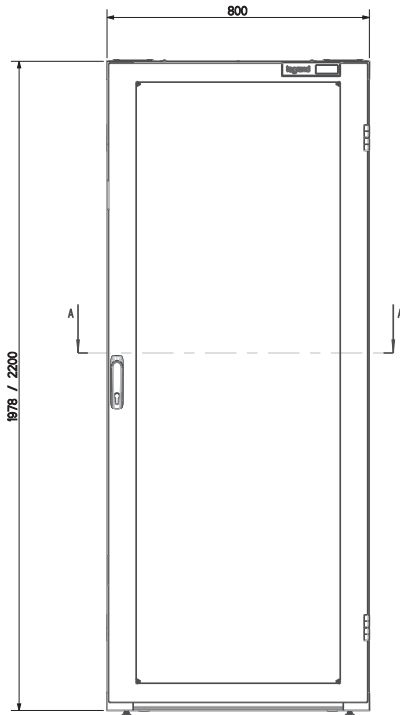
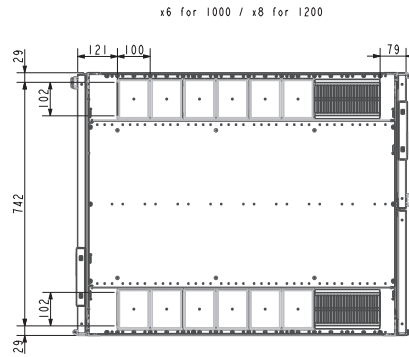
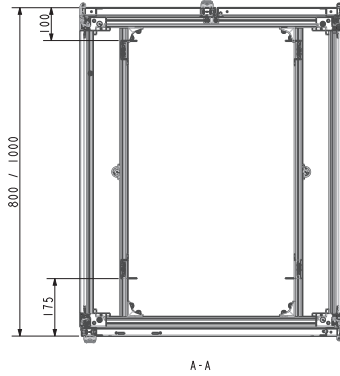

Height	Width (mm)	Depth (mm)	Black (RAL 9005)
42 U	600	1000	446441
		1200	446442
	800	1000	446443
		1200	446444
47 U	600	1000	446445
		1200	446446
	800	1000	446447
		1200	446448

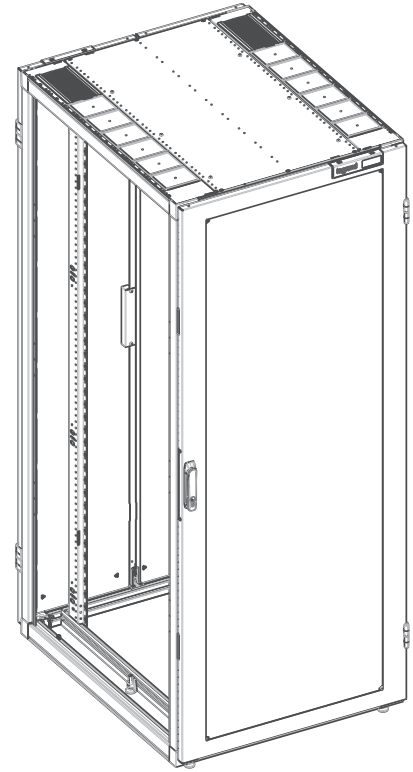
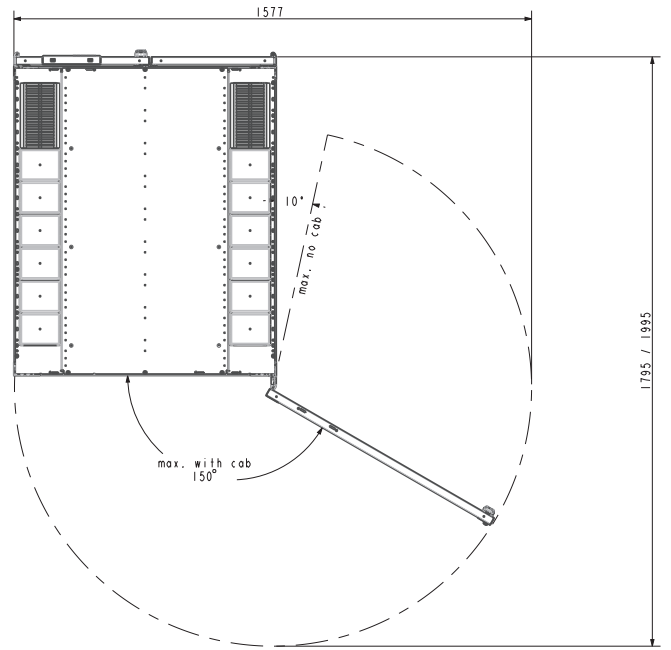
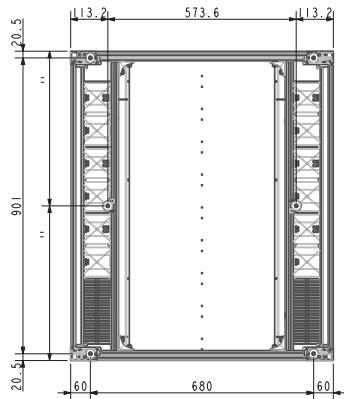
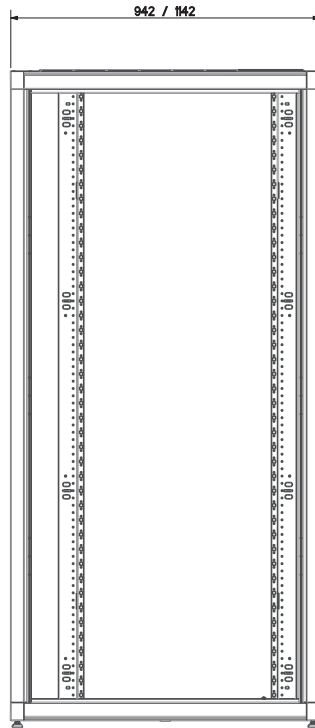
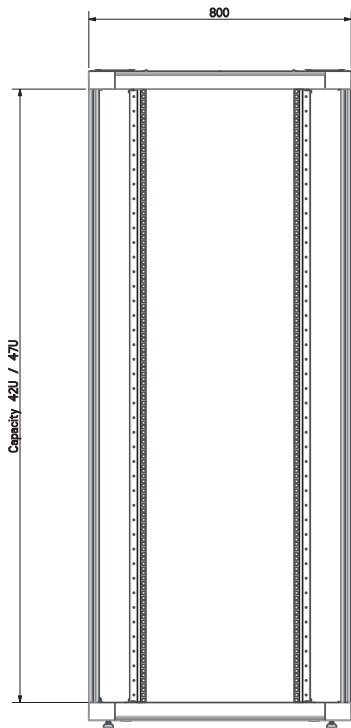
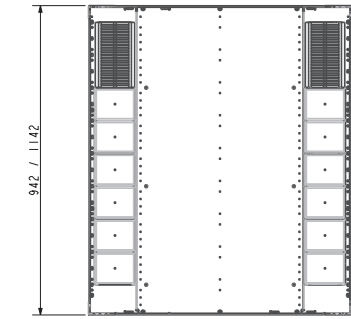

Server cabinets with airflow management

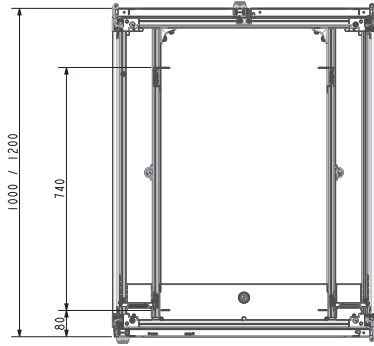

A-A

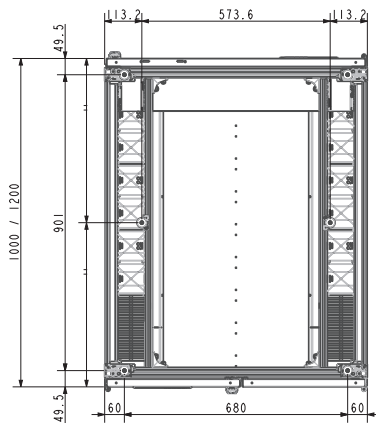
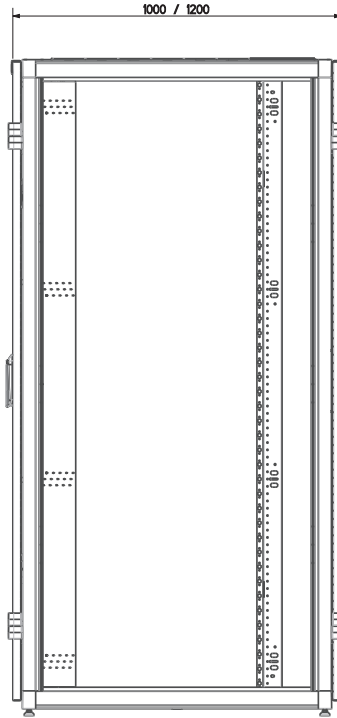
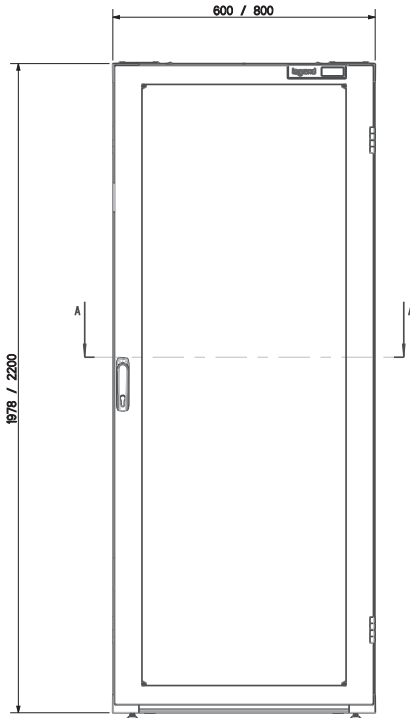
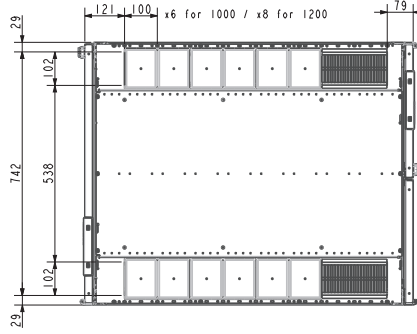

Height	Width (mm)	Depth (mm)	Black (RAL 9005)
42 U	600	1000	446449
		1200	446450
	800	1000	446451
		1200	446452
47 U	600	1000	446453
		1200	446454
	800	1000	446455
		1200	446456

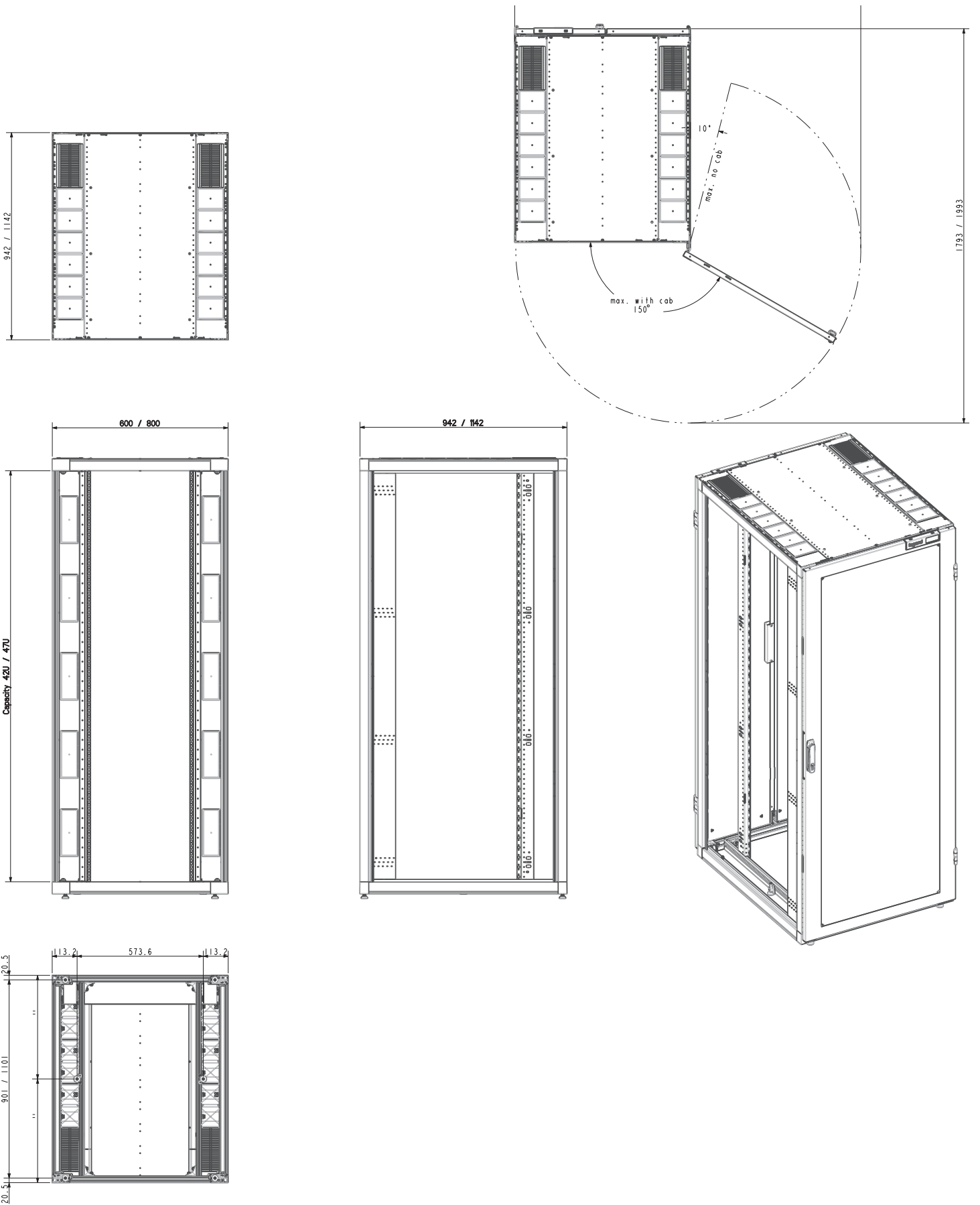

Accessories

Vertical cable management

Cable tray



446464
Cable tray

The powder coated cable tray 100 mm, 200 mm and 300 mm wide is used for vertical cable management. It has numerous possibilities for organizing your cabling. Cables can be attached to the tray using tie-wraps and/or Velcro. The toolless mount plastic cable rings may also be fitted to this cable tray. Cable trays are available in various heights. Cable Trays are fixed to the upper and lower frame where the threaded mounting rails integrated in the frame enables stepless adjustment of the cable tray in depth direction. This flexible feature ensures your cable management tray is placed exactly where it is needed.

Pack	Article number	Cable tray		
1	446463	Colour	Height in U	Width in mm
1	446464	Black	24	200
1	446465	Black	42	200
		Black	47	200

Vertical cable management

Cable rings



446477
Cable ring



446478
Cable ring with brackets to fix to frame

The cable rings are a high quality product made out of a combination of glass fiber reinforced with nylon that ensures a solid product with a certain degree of flexibility but nearly impossible to deform or even break! The brackets can be mounted without the use of any tools on the cable trays and on the vertical cable management profiles (ordered separately) that attach to the VMRs, if you opt for the ring with bracket, it enables the possibility of mounting them onto the height posts. They come in a set of 10 pieces.

Pack	Article number	Cable ring
10	446477	Cable ring
10	446478	Cable ring with brackets to fix to frame

Vertical cable management

Mounting profile for cable management on VMR



446471
Mounting profile for cable management on VMR

This sheet metal strip with an U shape has been designed to enable a toolless mount of cable management accessories in front of your VMRs. First the strip must be installed in front of your VMR profile with the use of screws and then cable fingers and cable rings can be placed in the punched pattern present in the strip. There are holes that allow the mounting of steel cable rings as well with the use of screws. A final remark is that PDU brackets can no longer be placed on VMRs when this strip is used.

Pack	Article number	Mounting profile	
1	446470	Colour	Height in U
1	446471	Black	24
1	446472	Black	42
1	446472	Black	47

Vertical cable management

Wire mesh cable tray and PDU cable tray



446460
Wire mesh cable tray



446466
PDU

The zinc-blue passivated wire mesh cable tray offers various possibilities for vertical cable management within the rack. Cables can be attached to the wire mesh over the entire height of the rack. Wire mesh cable trays are the right choice for high volume (structured) cabling. They are fixed to the upper and lower frame where the threaded mounting rails integrated in the frame enables stepless adjustment of the cable tray in depth direction. This flexible feature ensures your cable management tray is placed exactly where it is needed.

The powdercoated PDU cable tray 170mm wide is used for PDU placement as well as vertical cable management. It features three vertical patterns of key holes for placement of toolless mount PDU's. The pitch of the key holes is 7U and therefore fits to most PDU's available in the market (Raritan, Servertech, Legrand, ...). The width of 170mm ensure placement of up to 3 PDU's (width approx. 1U), 2 (Intelligent PDU's,) or 1 (High-Density) PDU. It has possibilities for organizing your cabling. Cables can be attached to the tray using tie-wraps and/or Velcro. The toolless mount plastic cable rings may also be fitted to this cable tray. Cable trays are available in various heights. Cable Trays are fixed to the upper and lower frame where the threaded mounting rails integrated in the frame enables stepless adjustment of the cable tray in depth direction. This flexible feature ensures your cable management tray is placed exactly where it is needed.

Pack	Article number	Wire mesh cable tray		
1	446460	Height in U	Width in mm	
1	446461	42	200	
1	446462	47	200	
1	446462	24	200	

Pack	Article number	PDU cable tray		
1	446466	Colour	Height in U	Width in mm
1	446467	Black	42	170
1	446467	Black	47	170

Accessories

Cable guiding accessories

Steel cable rings



446481
Cable management ring steel

446482
Steel cable rings

446483
Cable ring steel VMR

These steel cable rings are used for the assembly of cable bundles. They come in sets of 10 pcs.

Pack	Article number	Steel cable rings
10	446481	Steel cable rings to mount on height profile
10	446482	Steel cable rings to mount on cable tray & height profile
10	446483	Steel cable rings to mount on VMR

Cable guiding accessories

Cable guides



446491 - 446492 - 446493
Cable guides

The cable guides are a high quality product made out of a combination of glass fiber reinforced with nylon that ensures a solid product with a certain degree of flexibility but nearly impossible to deform or even break! These cable guides are mounted on our vertical cable management profiles (ordered separately) that attach to the VMRs, you can choose to build up your own solution combining heights of 4 and 5 Units or choose our already predefined combinations for complete 24, 38, 42, 47 or 52 Units. These cable guides include a snap-on feature to allow the placement of our bend radius cover that improves the curvature radius for your cables when needed!

Pack	Article number	Cable guides
1	446491	Height in U 24
1	446492	47
1	446493	52

Cable management

Pull and relief tying brackets



446479
Frame pull and relief tying brackets



446480
Roof pull and relief tying brackets

The pull-relief cable managers are a brand new smart approach to cable management made possible thanks to the flexibility in all 3 directions that the Legrand cabinet provides. They come as a set of 10 pieces and can be mounted either on the frame (top& bottom) or on the roof. Thanks to the use of velcro you can easily put together a set of cables and also separate them whenever needed.

Pack	Article number	Pull and relief tying brackets
10	446479	Frame pull and relief tying brackets
10	446480	Roof pull and relief tying brackets

Cable management

Tool-less mount cable guides for fiber optic cabling



446476
Tool-less mount cable guides

The bend radius covers introduces one of the many new features implemented in our new platform, this accessory can be easily fixed to the cable guides completely toolless thanks to a snap-on feature integrated in the product. This item optimizes your cable management radius to work best with fiber-optic solutions.

Pack	Article number	Cable guides
10	446476	Tool-less mount

Accessories

Airflow management

Brush for side skirt



446475
Brush for side skirt 200mm (d)

This cable entry accessory is to be placed in the side-skirts (part of the airflow package). The cable entry brush version provides cable throughput in a cost efficient manner.

Pack	Article number	Brush for side skirt
1	446475	Depth in mm 200

Airflow management

Plinth front/rear



446457
Plinth front/rear

446494
Plastic front panel 1U

This front-rear sheet metal plinth adds an increased level of air tightness to the cabinet. Recommended when leveling feet are in use to achieve the best airflow control and prevent airflow leakage. These plinths can be used with the L shape protruding towards the outside of the cabinet to facilitate the floor tile alignment. Then it is possible to install them with the L shape inwards. Ending up with a seamless solution between cabinet and plinth.

The plastic front panel serves to seal off the 19-inch area so that it is airtight. The front panel have been specially designed to make installation easy and to form an airtight 19-inch seal. The front panel is easy to mount between the 19-inch profiles. No materials are needed for securing the front panel. Air tight accessories enable energy savings by preventing air leakage.

Pack	Article number	Plinth front/rear		
1	446457	Colour	Height in U	Width in mm
1	446458	Black	22-47	600
1	446459	Black	22-47	800
1	446499	Black	0-25	800
		Black	0-25	600
		Plastic front panel		
25	446494	Height in U		
		1		

Airflow management

Cover plate with fan unit



446468
Cover plate with fan unit



446485
Thermostat

The fan unit contains three axial fans. The flow with no load is 480 m³/h. Under normal loads it will be over 300 m³/h. The connection is made using IEC-320 C13 connectors. The fan units can be combined using a cable with IEC-320 C13 / C14 connectors. As an additional option, this fan unit can be switched automatically using the thermostat.

Pack	Article number	Fan unit
1	446468	Cover plate with fan unit
1	446485	Thermostat Use the thermostat to switch the fan unit automatically

PDU bracket

Frame PDU-bracket



446473
Frame PDU-bracket

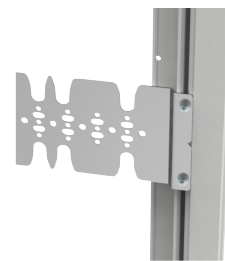

446474
PDU Power bracket 2 fold

PDU bracket to mount PDU in a cabinet

Pack	Article number	Frame PDU-bracket
1	446473	Single
1	446474	Twofold

Accessories

Mechanical accessories

Frame baying bracket



446469
Frame baying bracket

The baying kit is used to connect two cabinets. All external but only accessible once the doors of both cabinets are open, ensuring the security of the solution, when the doors are closed these baying sets are not accessible.

Pack	Article number	Frame baying bracket
6	446469	Set of baying brackets for connecting cabinets

Cabinet accessories for side

Horizontally split side panel



446420
Horizontally split side panel

The powder coated horizontally split side panel is especially used for so-called end-of-row applications. It consists of a bottom and top panel, and a middle support beam. The lower side panel is supported by the frame. The top side panel is supported by the middle beam. Due to the fact the side closure comes horizontally split, it ensures easy handling. The panels also feature quarter turn locks that automatically guarantee an earthing connection to the frame once locked. No more hassle with earthing cables! Set of two plinths are included.

Pack	Article number	Horizontally split side panel	Colour	Height in U	Depth in mm
1	446420		Black	42	1000
1	446421		Black	42	1200
1	446422		Black	47	1000
1	446423		Black	47	1200

Cabinet accessories for bottom

Castors



446484
Cable wheel LD AP (2pcs)

Castors provide you the option of moving your cabinet more often, more quickly and more easily.

Pack	Article number	Castors
1	446484	Colour Black

Cabinet accessories for bottom

Adjustable base legs



446498
Adjustable base legs (side)

446497
Adjustable base legs (middle)

The adjustable feet are needed for positioning the cabinet horizontally.

Pack	Article number	Adjustable base legs	
2	446497	Position middle	Height in mm 61
4	446498	side	61

Cabinet accessories for top
Plastic blind plate



446486
 Cover roof plate

The plastic blind plates have been specifically design to fulfill our flexibility and modularity approach. These plates can be easily placed on your right and/or left roof cutouts to completely cover gaps where they are not desired and allow you to adapt your solution to your specific needs. Not only they come as a piece of 200 in width, but in order to provide you with a higher degree of flexibility, these plates have been designed to allow you to easily split them into 2 plates of 100 mm that you may install in different positions of your roof.

Pack	Article number	Plastic blind plate for top
6	446486	Depth in mm 200

Cabinet accessories for top
Cable entry brush

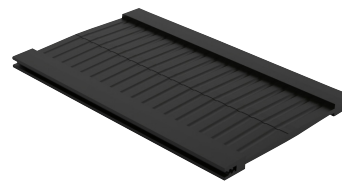

446487
 Cable entry brush

The brushes have been specifically design to fulfill our flexibility and modularity approach. These brushes can be easily placed on your right and/or left roof cutouts and allow you to adapt your solution to your specific needs. There are several lengths to choose from in order to provide you with the dimensions that better suit your needs.

Pack	Article number	Cable entry brush for top
1	446487	Depth in mm 200

Cabinet accessories for top

Cable guide (left or right side)



446488
Guide bend radius (2pcs)

The cable guides have been specifically design to fulfill our flexibility and modularity approach. These items can be easily placed on your right and/or left roof cutouts and allow you to adapt your solution to your specific needs, facilitating the management of top-of-cabinet cables. These come in a set of two pieces that cover a pitch of 100 mm and can be extended as much as desired over the total length of the roof cutout and then finalized with a single set of the Cable guide end plates, that fit at the front and rear of your solution. It is also possible to purchase a single set combining 4 pieces, 2 for the sides and another 2 for the front and rear and achieve a solution for a 100 mm pitch.

Pack	Article number	Cable guide
2	446488	Cable guide
2	446489	Cover plate for cable guide
2	446490	Combination of the previous two (cable guide including cover plate)

Cabinet accessories for top

Cable entry brush and cable guide (middle)



446495
Cable entry brush for top (middle)



446496
Cable guide for top (middle)





The cable entry brushes in combination with a small sheet metal plate are used in combination with a roof layout that includes a cutout in the middle plate. Not only this cutout enables the mounting of these brushes, but also of blind plates, bend radius guides for better curvature and a triple-fan unit.

This set of cable guides together with a small sheet metal plate are used in combination with a roof layout that includes a cutout in the middle plate. Not only this cutout enables the mounting of these cable guides, but also of blind plates, brushes and a triple-fan unit.

Pack	Article number	Cable entry brush for top
1	446495	Position Middle
1	446496	Cable guide for top Position Middle



FOLLOW US
ALSO ON

- @ legrand.com
-  youtube.com/user/legrand
-  facebook.com/Legrand
-  twitter.com/Legrand
-  pinterest.com/legrandgroup
-  instagram.com/legrandnews



Headquarters

128, avenue de Lattre de Tassigny
87045 Limoges Cedex
France
Tel.: + 33 (0) 5 55 06 87 87
Fax: + 33 (0) 5 55 06 88 88