

## Strumento multifunzione trifase con 1 o 2 ingressi "Easy Connect"

Codici: MFD41ORFCDT – MFD42ORFCDT  
 MFD41ORFCMT – MFD42ORFCMT  
 Modello: NEMO D4-ec



ROG630M2	ROG1600M2	ROG3200M2	ROG6300M2
Ø 50mm	Ø 100mm	Ø 150mm	Ø 240mm



Sommario	Pagine
1. Uso .....	1
2. Gamma .....	1
3. Installazione .....	1
4. Dimensioni .....	1
5. Connessioni .....	2
6. Dati operativi .....	3
7. Caratteristiche generali .....	3
8. Conformità e certificazioni .....	5
9. Comunicazione .....	6

### 1. USO

Lo strumento multifunzione, in 4 moduli DIN, è dotato di connettore rapido per il collegamento del trio di sensori di corrente di tipo Rogowski (versioni da 630A/ 1600A/ 3200A/ 6300A).

Lo strumento misura in 4 quadranti, adatto per reti 3N-3E e 3-3E.

### 2. GAMMA

Codice Art.	Ingressi I	Uscita	Ingressi Digitali	Range Tensione
MFD41ORFCDT	1	Modbus	4 Tariffe	V-NV-V: 3x230/ 3x400±15% V-V: 3x230 ±15%
MFD42ORFCDT	2			
MFD41ORFCMT	1	Mbus		
MFD42ORFCMT	2			

Codice	Bobine Rogowski Apribili				Lunghezza cavo (m)	Diametro (mm)
	Ingresso (A)	Corrente min. (A)	Corrente max. (A)			
ROG630M2	630	12,5	750	2	50	
ROG1600M2	1600	32,5	1950	2	100	
ROG3200M2	3200	65,0	3900	2	150	
ROG6300M2	6300	125,0	7500	2	240	
Codice cavo				Lunghezza cavo (m)	Quantità	
ROGEXTM1	-	-	-	1	x 3 max.	
ROGETXM3	-	-	-	3	x 1 max.	

### 3. INSTALLAZIONE

#### Fissaggio:

Su rotaia simmetrica EN/IEC 60715 o guida DIN 35.

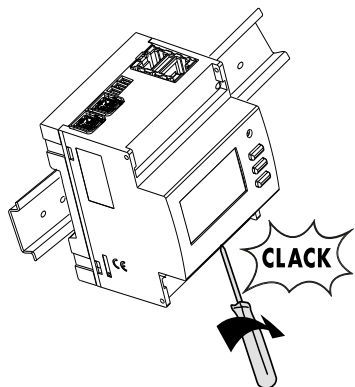

### Posizione di funzionamento:

Verticale, Orizzontale, Sottosopra, Sul lato

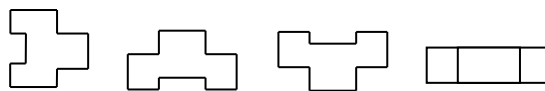

### 4. DIMENSIONI

Custodia: 4 moduli DIN43880

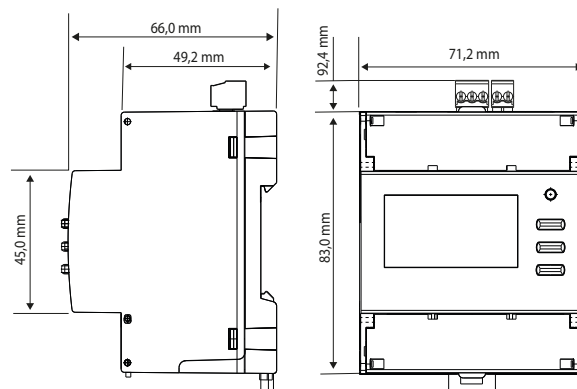

# Strumento multifunzione trifase con 1 o 2 ingressi "Easy Connect"

Codici: MFD41ORFCDT – MFD42ORFCDT  
MFD41ORFCMT – MFD42ORFCMT

Modello: NEMO D4-ec

## 5. CONNESSIONI - COLLEGAMENTO

### Schemi di inserzione:

- Rete trifase a 4 fili o a 3 fili (3N3E; 3-3E)

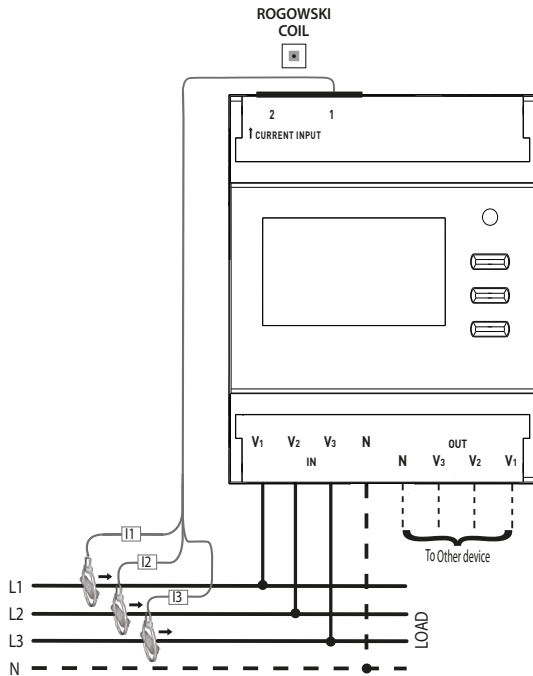

- Schema con 2 sonde:

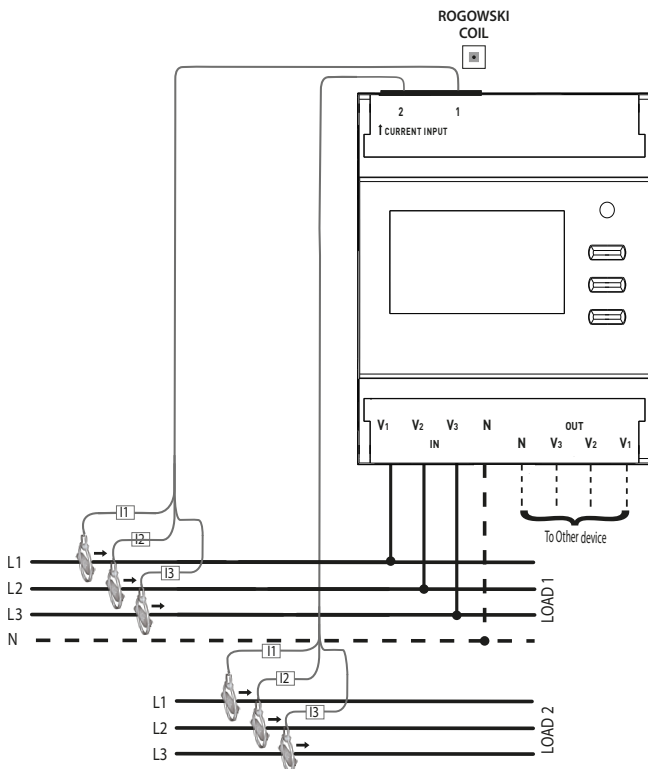

## 5. CONNESSIONI - COLLEGAMENTO

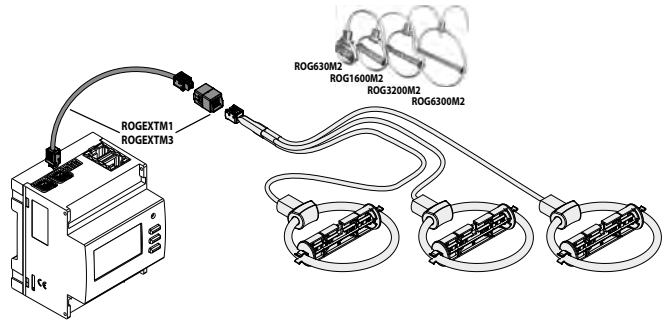

- Sensore Rogowski – Lunghezza del cavo

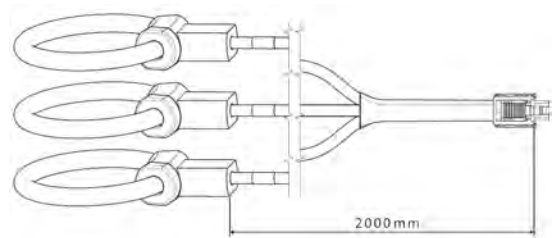

Questa lunghezza può essere estesa tramite il cavo di prolunga + connettore fino a 5 metri (2 m di cavo Rogowski e fino a 3 m di prolunga)

- **ROGEXTM1, ROGEXTM3:**

Cavo di prolunga per bobine Rogowski

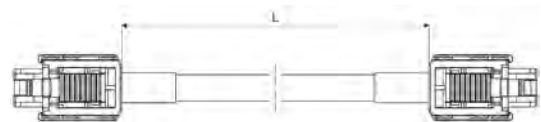

Codice art.	Lunghezza (mm)
ROGEXTM1	1000
ROGEXTM3	3000

Supporto centratore in plastica per bobine Rogowski

Codice art.	Lunghezza (mm)
ROG630M2	79
ROG1600M2	123
ROG3200M2	173
ROG6300M2	263

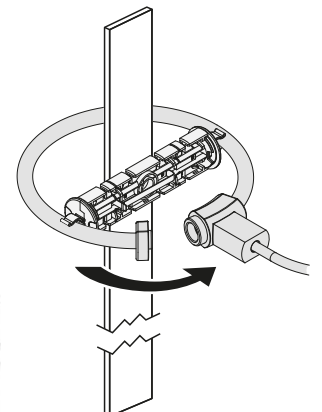
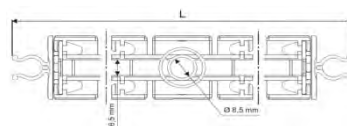

# Strumento multifunzione trifase con 1 o 2 ingressi "Easy Connect"

Codici: MFD41ORFCDT – MFD42ORFCDT  
MFD41ORFCMT – MFD42ORFCMT

Modello: NEMO D4-ec

## 6. DATI OPERATIVI

### 6.1 ELETTRICI

Per tutti i codici MFD41ORFCDT – MFD42ORFCDT – MFD41ORFCMT - MFD42ORFCMT la portata di riferimento (Iref) è programmabile in base alle Rogowski scelte:

Portata correnti	I <sub>min</sub>	I <sub>ref</sub>	I <sub>max</sub>
630	12,5A	250A	750A
1600	32,5A	650A	1950A
3200	65A	1300A	3900A
6300	125A	2500A	7500A

### Tensioni V1,V2,V3,N:

- Tensione trifase: V-N/ V-V : 3x230 /3x400 ±15%  
V-V: 3x230 ±15%

### Sezione massima cavi collegabili ai morsetti V1,V2,V3,N:

Morsetti	Senza bussola	Con bussola
Cavo rigido	0,05 + 1,5 mm <sup>2</sup>	0,05 + 2,5 mm <sup>2</sup>
Cavo flessibile	0,05 + 1,5 mm <sup>2</sup>	0,05 + 2,5 mm <sup>2</sup>

### Autoalimentato (morsetti V e N):

- Frequenza nominale: 50/60Hz  
- Frequenza di funzionamento: 45...65Hz  
- Autoconsumo: ≤ 2,5VA"@230 Vca

**Massima potenza termica dissipata per il dimensionamento termico dei quadri: ≤ 5W**

## 6.2 MECCANICI

### Morsetti a vite:

- Max ingombro esterno: 18mm  
- Lunghesse della spelatura del cavo per ingresso e bus 5mm;  
per tensioni in/out 7,5mm

### Testa della vite:

- Morsetti di collegamento delle tensioni (V1, V2, V3, N) viti COMBI (testa con intaglio/croce PH1) mentre per morsetti (N, V3, V2, V1): viti a testa con intaglio.  
- Morsettiere nella parte superiore del multifunzione (ingresso e bus): viti a testa con intaglio

### Coppia di serraggio raccomandata:

- Morsetti di collegamento delle tensioni (V1, V2, V3, N): 0,5Nm  
- Morsetti di collegamento delle tensioni (N, V3, V2, V1): 0,5Nm  
- Morsettiere tariffe e comunicazione (Modbus o Mbus): 0,2 Nm

### Utensili necessari:

- Per morsetti versione BUS utilizzare cacciavite a taglio da 2,5mm;  
per morsetti tensioni utilizzare cacciaviti a taglio da 3,5mm e/o con impronta a croce PH1

## 7. CARATTERISTICHE GENERALI (continua)

### Dati di marcatura:

Marcatura indelebile

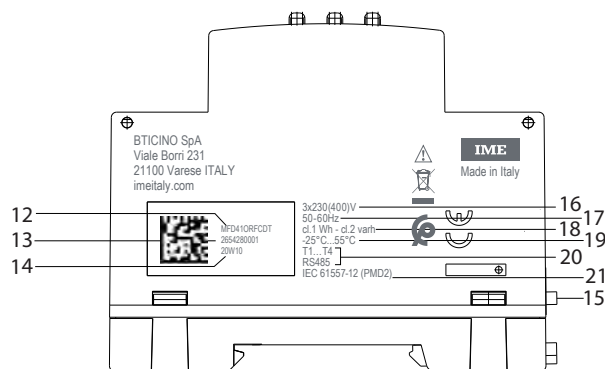
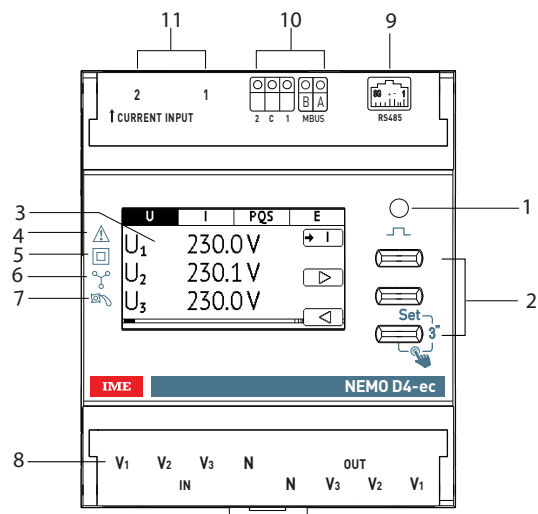

1. LED metrologico
2. Tastiera a 3 pulsanti multifunzionali
3. Display grafico
4. Consultare manuale d'uso prima dell'installazione
5. Doppio isolamento
6. Inserzione su linea trifase 4 fili / 3 fili
7. Dispositivo antirotazione \*cpvK getgo gpvq+
8. Tensioni
9. Connessione RJ45 per Modbus RTU
10. Comunicazione Mbus ed ingresso tariffario
11. Ingresso correnti 1 / 2
12. Codice articolo
13. Datamatrix per tracciabilità prodotto
14. Settimana e anno di fabbricazione
15. Tensioni
16. Tensioni nominali
17. Frequenze nominali
18. Classi di precisione
19. Temperatura d'impiego
20. Ingressi / Uscite
21. Norme di riferimento

# Strumento multifunzione trifase con 1 o 2 ingressi "Easy Connect"

Codici: MFD41ORFCDT – MFD42ORFCDT  
MFD41ORFCMT – MFD42ORFCMT

Modello: NEMO D4-ec

## 7. CARATTERISTICHE GENERALI

### Laseratura:

#### Lato Sinistro

Informazioni di tracciabilità

#### Lato Destro

Schemi di collegamento

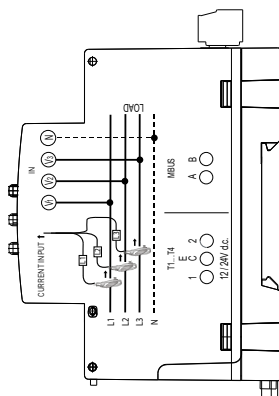
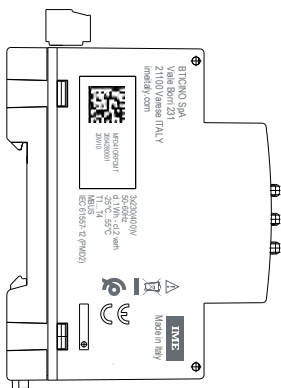
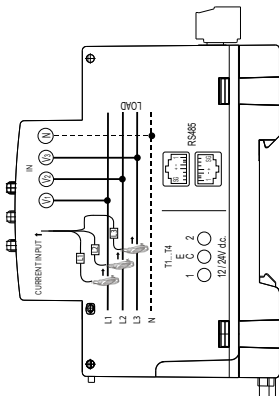
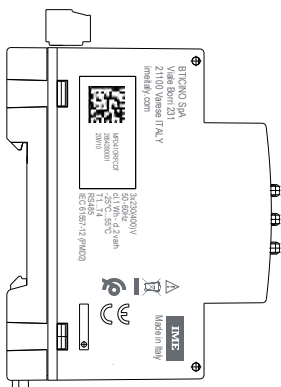

### Marcature uscite comunicazione e ingressi tariffari:

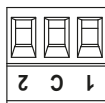
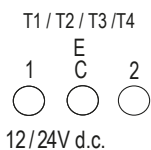

#### RS485



#### MBUS

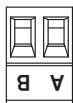

## 7. CARATTERISTICHE GENERALI (continua)

### Display e LED metrologico :

- Grafico retroilluminato 1,8 pollici (256x128).

Ingressi Rogowski	Risoluzione Energie	Wh/imp.
630A	1kWh/kvarh/kVAh	10
1600A	1kWh/kvarh/kVAh	25
3200A	1kWh/kvarh/kVAh	50
6300A	0,01MWh/Mvarh/MVAh	100

### Visualizzazione del valore e programmazione:

- Attraverso la tastiera frontale, 3 pulsanti (vedi al manuale dell'utente).
- Accesso protetto da codice di identificazione (**codice predefinito 1000**)

### Grandezze misurate e precisione in conformità ENIEC 61557-12

- Corrente: cl.1
- Tensione: cl.0,5
- Frequenza:  $\pm 0,1$  Hz
- Potenza totale attiva istantanea, fase, valore medio e max. valore medio: cl.1
- Potenza totale reattiva istantanea, fase, valore medio e max. valore medio: cl.2
- Potenza totale apparente istantanea, fase, valore medio e max. valore medio: cl.1
- Fattore di Potenza: cl.1
- Energia attiva totale e parziale, tariffarie, di fase, positiva e negativa cl.1
- Energia reattiva totale e parziale, tariffe, di fase, positiva e negativa cl.2
- Energia apparente cl.1

**Le classi sopra indicate sono garantite mantenendo la centratura, tra sensore Rogowski e conduttore primario, con gli appositi accessori forniti ed un contenuto armonico entro i limiti della EN/IEC 61557-12**

### Analisi armonica (THD): valore e grafico

- Fino alla 15° armonica

### Potenza media:

- Grandezza: potenza attiva, reattiva, apparente
- Calcolo: media mobile, sul periodo selezionato
- Tempo media: 3/5/8/10/15/20/30/60min
- Load Profile (Curva di carico di potenza), diagramma degli ultimi 24 valori di Potenza media registrati:

#### Tempo di media impostato | Intervallo della curva

3 min	72 min
5 min	2 ore
60 min	24 ore

### Contaore azzerabile:

- Conteggio di ore e minuti di funzionamento
- Risoluzione 8 cifre (6 per le ore + 2 per i minuti)
- Visualizzazione massima: 999999.99
- Valore programmabile: 0...50% Pn (Potenza attiva positiva)

## Strumento multifunzione trifase con 1 o 2 ingressi "Easy Connect"

Codici: MFD41ORFCDT – MFD42ORFCDT  
MFD41ORFCMT – MFD42ORFCMT

Modello: NEMO D4-ec

### 7. CARATTERISTICHE GENERALI

#### Ingresso digitale

- L'ingresso digitale permette la commutazione del conteggio di energia su 4 tariffe
- 3 morsetti di ingresso con punto in comune (1 - C - 2)

Morsetti	Senza bussola	Con bussola
Cavo rigido	0,05 + 1,5 mm <sup>2</sup>	0,05 + 2,5 mm <sup>2</sup>
Cavo flessibile	0,05 + 1,5 mm <sup>2</sup>	0,05 + 2,5 mm <sup>2</sup>

- Tensione nominale: 12-24V dc, 10mA Max

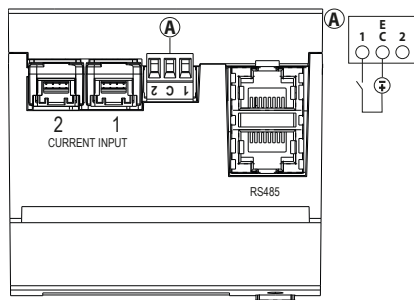

#### Caratteristiche della porta di comunicazione ModBus:

- Indirizzi programmabili: 1 a 247(5\*)
- Velocità di comunicazione: 4,8 – 9,6 – 19,2\* – 38,4 kbps
- Bit di parità: nessuno, pari\*, dispari
- Bit di stop: 1
- Isolata galvanicamente rispetto agli ingressi di misura
- Standard RS485 3 fili, Half-Duplex, su connettore RJ45
- Protocollo Modbus® RTU
- Tempo di risposta: ≤ 200ms
- Resistenza di terminazione da 120Ω interna allo strumento (impostabile dal menù di SETUP, valore di default none\*)
- **MFD41ORFCDT:** Indirizzo programmabile da 1 a 247
- **MFD42ORFCDT:** Indirizzo programmabile da n = 1 a n = 246 per misure primo ingresso e indirizzo n+1 (assegnato automaticamente) per misure secondo ingresso

#### Caratteristiche della porta di comunicazione MBus:

- Standard: EN 13757
- Trasmissione: asincrona seriale
- N°-bit: 8
- Bit di parità: pari fissa
- Velocità di comunicazione: 300-600-1.200-2.400\*-4.800-9.600bit/s
- N° indirizzo primario: 0\*...250
- **MFD41ORFCMT / MFD42ORFCMT:**  
Indirizzo primario programmabile da 0 a 250
- **MFD41ORFCMT / MFD42ORFCMT:**  
Indirizzo secondario programmabile da 0 a 99999999
- Load MBus: 1
- Isolata galvanicamente rispetto agli ingressi di misura
- Misure trasferite: vedere protocollo di comunicazione

#### \* Dati di fabbrica

### 7. CARATTERISTICHE GENERALI

#### Raccomandazioni:

**Per la protezione del dispositivo contro sovraccarichi e cortocircuiti, si consiglia di utilizzare un interruttore magnetotermico**

#### Classe di protezione:

- Indice di protezione dei terminali rispetto ai contatti diretti: IP 20 (IEC/EN 60529);
- Indice di protezione faccia frontale contro i contatti diretti: IP 54 (IEC/EN 60529);
- Classe II: pannello frontale con placca;
- Classe di protezione contro gli impianti meccanici IK03 (IEC/EN 62262)

#### Resistenza alle vibrazioni:

- Vibrazione: da 5 a 150Hz ampiezza 0,15mm/1g
- Shock: 19g / 16msec

#### Materiale:

BLEND >PC + ABS<;

Identificazione secondo ISO 11469: >PC<;

GWFI IEC 60965-2-12 (§1.6mm): 850°C;

Classificazione reazione alla fiamma UL 94 / IEC 60695\_11\_10 (1.6/3.2 mm): V2;

#### Temperature ambiente di esercizio:

- Tmin. = - 20 °C; Tmax. = + 60 °C.

#### Temperature ambiente di immagazzinamento:

- Tmin. = - 25 °C; Tmax. = + 70 °C

**Peso:** 0,270Kg

**Volume imballato:** 1,5 dm<sup>3</sup>.

**Ambiente:** meccanico M1 - elettrico E2

## Strumento multifunzione trifase con 1 o 2 ingressi "Easy Connect"

Codici: MFD41ORFCDT – MFD42ORFCDT  
MFD41ORFCMT – MFD42ORFCMT

Modello: NEMO D4-ec

### 8. CONFORMITÀ E CERTIFICAZIONI

#### Isolamento

- Categorie di misura: III (in base alla EN-61010)
- Grado di inquinamento: 2
- Tensione di isolamento, Ui: 300V, Fase-Neutro

#### Rigidità dielettrica:

- Alimentazioni / Uscite: 3kV / 50Hz / 1min
- Involucro / Terminali: 4kV / 50Hz / 1min

#### Impulso:

- Alimentazioni: 6.3kV / 1,2 – 50µsec / 0,5J

#### Conformità alle norme:

- Classe di precisione: Energia attiva classe 1 (IEC/EN62053-21)
- Classe di precisione: Energia reattiva classe 2 (IEC/EN62053-23)
- Compatibilità elettromagnetica: Prove in accordo alla EN/IEC 62052-11 / GP\*83548/3
- Classe di precisione in conformità alla IEC/EN61557-12
- 2014/35/UE 2014/30/UE

#### Rispetto dell'ambiente - Conformità alle direttive CEE:

- Conformità alla direttiva 2011/65/UE modificata dalla direttiva 2015/863 (RoHS 2) relativa alle limitazioni circa l'utilizzo di alcune sostanze pericolose nelle apparecchiature elettriche ed elettroniche.
- Conformità al Regolamento REACH (1907/2006): alla data di pubblicazione di questo documento, nessuna sostanza inserita nell'allegato XIV è presente all'interno di questi prodotti.
- Direttiva RAEE (2012/19/EU): la commercializzazione di questo prodotto prevede un contributo agli eco-organismi incaricati, in ciascun paese europeo, della gestione del fine vita dei prodotti che rientrano nel campo di applicazione della Direttiva Europea sui Rifiuti di Apparecchiature Elettriche ed Elettroniche.

#### Materie plastiche:

- Materie plastiche senza Alogeni.
- Marcatura delle parti secondo le norme ISO 11469 e ISO 1043.

#### Imballi:

- Progettazione e produzione degli imballi ai sensi del Decreto 98-638 del 20/07/1998 e della direttiva 94/62/CE."

# Strumento multifunzione trifase con 1 o 2 ingressi "Easy Connect"

Codici: MFD41ORFCDT – MFD42ORFCDT  
MFD41ORFCMT – MFD42ORFCMT  
Modello: NEMO D4-ec

## 9.COMUNICAZIONE

### Schema di collegamento RS485 Modbus:

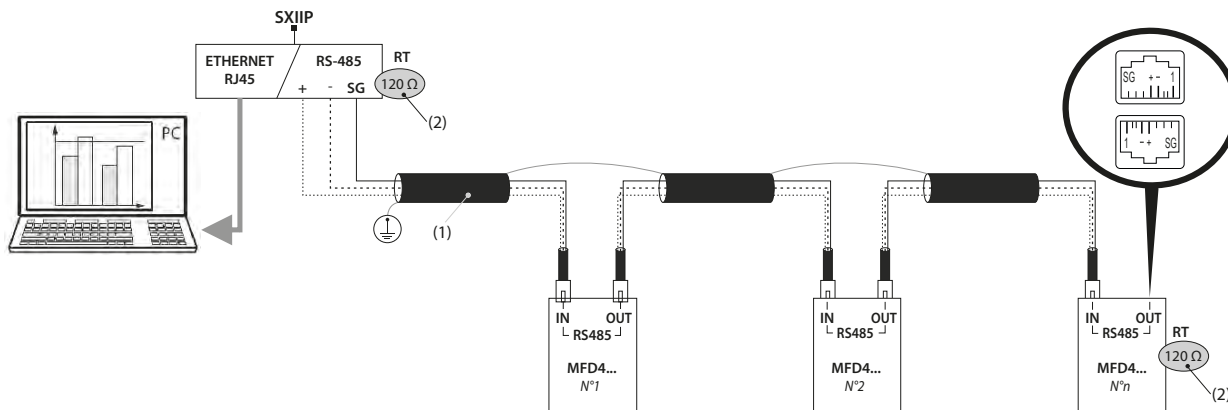

### Schema di collegamento RS485 Modbus con Mini Web Server:

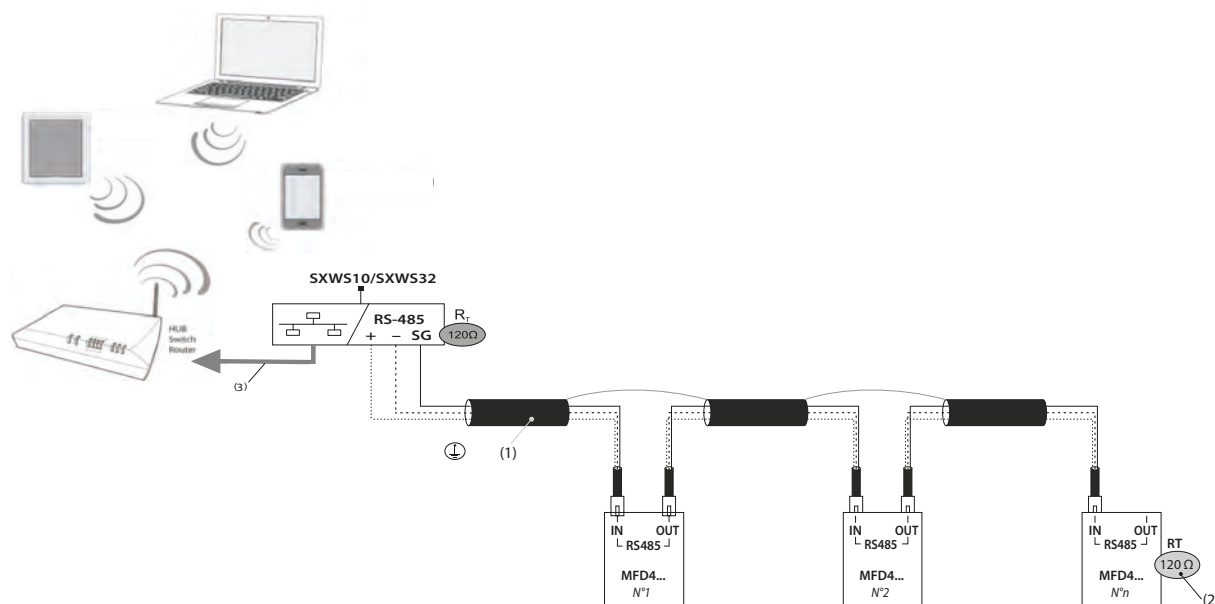

- (1) RS485: Prescritto utilizzo di cavo tipo Belden 9842, Belden 3106A (o equivalente) per una lunghezza massima del bus di 1000 m, o di cavo Categoria 6 (FTP o UTP) per una lunghezza massima di 50 m
- (2) Resistenza di terminazione da 120Ω interna allo strumento
- (3) Ethernet: Cat. 6 (FTP/UTP)
- (4) Il morsetto "SG" non va collegato a terra

### Schema di collegamento Mbus:

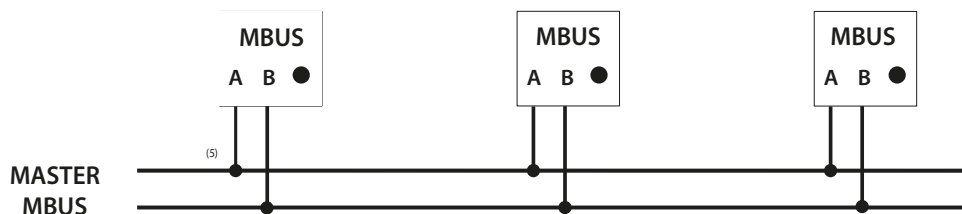

Collegamenti non polarizzati  
(5) Un cavo telefonico standard a due fili (JYStY N°2\*0.8 mm)

### Tabelle di comunicazione

- I protocolli di comunicazione MODBUS e MBUS sono disponibile sul sito <http://www.imeitaly.com>

## Three-phase multifunction instrument with 1 or 2 "Easy Connect" inputs

Codes: MFD41ORFCDT – MFD42ORFCDT  
MFD41ORFCMT – MFD42ORFCMT  
Model: NEMO D4-ec



ROG630M2	ROG1600M2	ROG3200M2	ROG6300M2
∅ 50mm	∅ 100mm	∅ 150mm	∅ 240mm



Contents	Pages
1. Use .....	1
2. Range .....	1
3. Installation .....	1
4. Dimensions .....	1
5. Connections .....	2
6. Operating data .....	3
7. General features .....	3
8. Conformity and certifications .....	5
9. Communication .....	6

### 1. USE

The multifunction instrument, 4 DIN modules, has a quick connector for the connection of the Rogowski type current coil trio (630A/ 1600A/ 3200A/ 6300A versions).

The measuring instrument with 4 dials, suitable for 3N-3E and 3-3E networks.

### 2. RANGE

Item Code	I Inputs	Output	Digital Inputs	Voltage Range
MFD41ORFCDT	1	Modbus	4 Tariffs	V-N/V-V: 3x230/ 3x400±15% V-V: 3x230 ±15%
MFD42ORFCDT	2			
MFD41ORFCMT	1	Mbus		
MFD42ORFCMT	2			

Code	Rogowski Openable Coils				Cable length (m)	Diameter (mm)
	Input (A)	Min. Current (A)	Max. Current (A)			
ROG630M2	630	12,5	750	2	50	
ROG1600M2	1600	32,5	1950	2	100	
ROG3200M2	3200	65,0	3900	2	150	
ROG6300M2	6300	125,0	7500	2	240	
Code				Cable length (m)	Quantity	
ROGEXTM1	-	-	-	1	x 3 max.	
ROGETXM3	-	-	-	3	x 1 max.	

### 3. INSTALLATION

#### Fixing:

On EN/IEC 60715 symmetrical rail or DIN 35 rail.

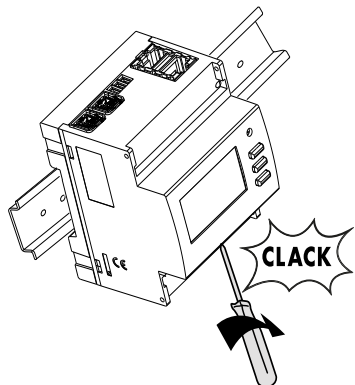

### Operating position:

Vertical, Horizontal, Upside down, On the side



### 4. DIMENSIONS

Housing: 4 DIN 43880 modules

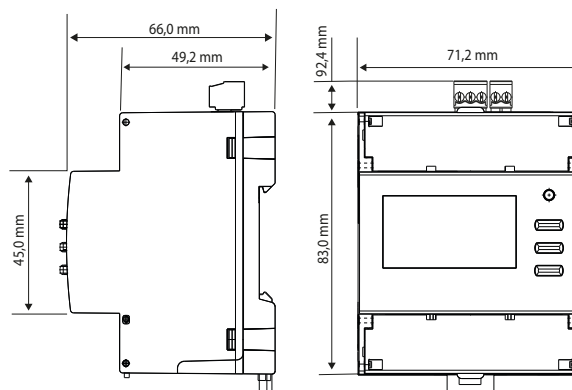



# Three-phase multifunction instrument with 1 or 2 "Easy Connect" inputs

Codes: MFD41ORFCDT – MFD42ORFCDT  
MFD41ORFCMT – MFD42ORFCMT

Model: NEMO D4-ec

## 5. CONNECTIONS

### Connection diagrams:

- 4-wire or 3-wire three-phase network ( 3N3E; 3-3E)

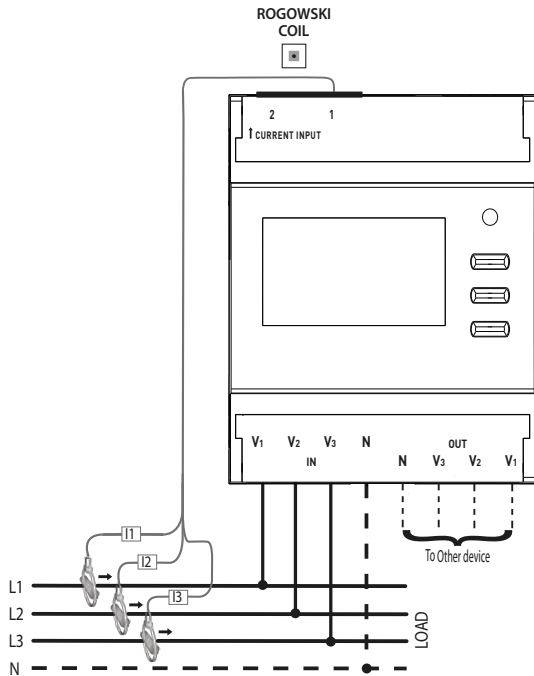

- Diagram with 2 coils:

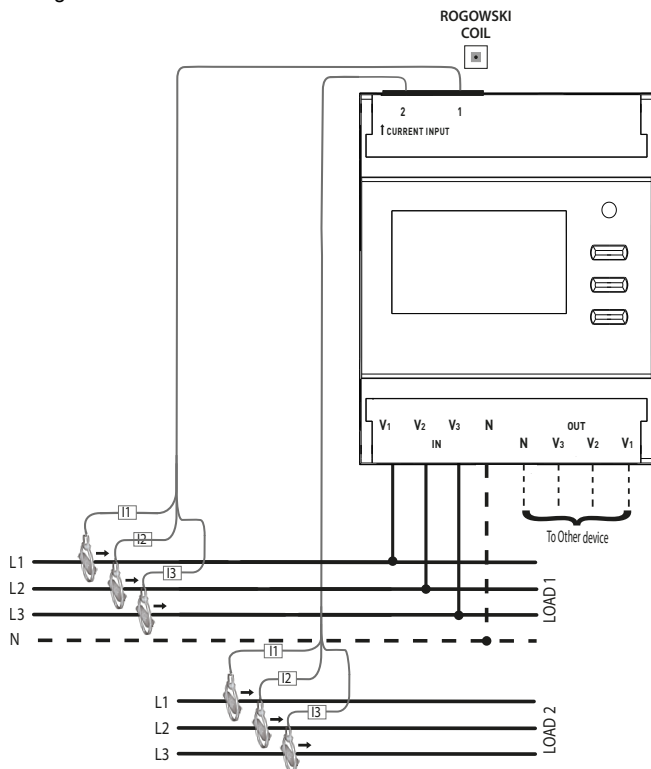

## 5. CONNECTIONS

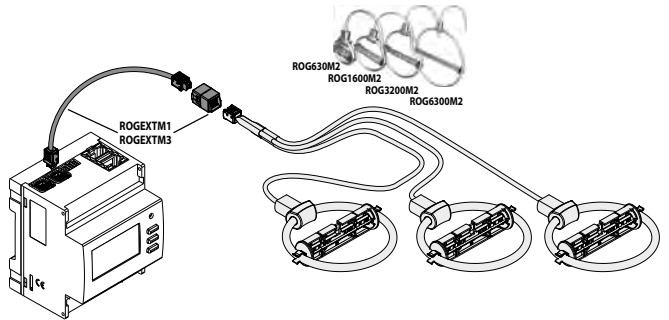

- Rogowski sensor – Cable length

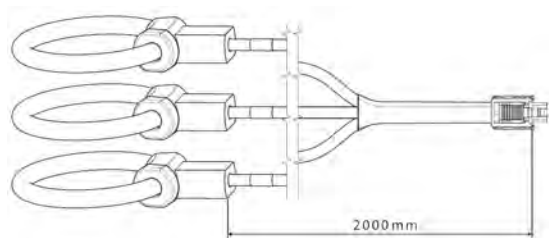

This length can be extended to 5 metres maximum with the extension cable + connector (2 m Rogowski cable and up to 3 m extension cable)

- **ROGEXTM1, ROGEXTM3:**

Extension cable for Rogowski coils

Item code	Length (mm)
ROGEXTM1	1000
ROGEXTM3	3000

Plastic centring support for Rogowski coils

Item code	Length (mm)
ROG630M2	79
ROG1600M2	123
ROG3200M2	173
ROG6300M2	263

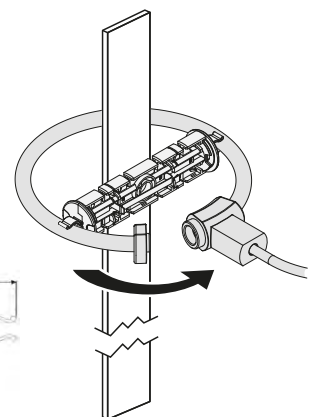
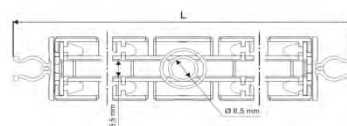

# Three-phase multifunction instrument with 1 or 2 "Easy Connect" inputs

Codes: MFD41ORFCDT – MFD42ORFCDT  
MFD41ORFCMT – MFD42ORFCMT

Model: NEMO D4-ec

## 6. OPERATING DATA

### 6.1 ELECTRIC DATA

For all the MFD41ORFCDT – MFD42ORFCDT – MFD41ORFCMT - MFD42ORFCMT codes the reference capacity (I<sub>ref</sub>) can be programmed based on the selected Rogowski:

Current capacity	I <sub>min</sub>	I <sub>ref</sub>	I <sub>max</sub>
630	12,5A	250A	750A
1600	32,5A	650A	1950A
3200	65A	1300A	3900A
6300	125A	2500A	7500A

### V1,V2,V3,N voltages:

- Three-phase voltage: V-N/ V-V : 3x230 /3x400 ±15%
- V-V: 3x230 ±15%

### Maximum section of the cables that can be connected to the V1,V2,V3,N terminals:

Terminals	Without bush	With bush
Rigid wire	0,05 + 1,5 mm <sup>2</sup>	0,05 + 2,5 mm <sup>2</sup>
Flexible wire	0,05 + 1,5 mm <sup>2</sup>	0,05 + 2,5 mm <sup>2</sup>

### Self-powered (terminals V and N):

- Rated frequency: 50/60Hz
- Operating frequency: 45...65Hz
- Self consumption: ≤ 2.5VA @230 Vac

### Maximum dissipated thermal power for the thermal dimensioning of the panels: ≤ 5W

## 6.2 MECHANICAL DATA

### Screw terminals:

- Max external dimensions: 18mm
- Stripping lengths for input cable and bus 5mm; 7.5mm for in/out voltages

### Screw head:

- Voltage connection terminals (V1, V2, V3, N) with COMBI screws (slotted/ PH1 Phillips head); slotted head screws for terminals (N, V3, V2, V1) .
- Terminal boards in the upper part of the multifunction (input and bus): screws with countersunk head with hexagon socket

### Recommended torque:

- Voltage connection terminals (V1, V2, V3, N): 0.5Nm
- Voltage connection terminals (N, V3, V2, V1): 0.5Nm
- Tariff and communication terminal boards (Modbus or Mbus): 0.2 Nm

### Necessary tools:

- For BUS version terminals, use a 2.5mm flat screwdriver; for voltage terminals, use a 3.5mm slotted screwdriver and/or a PH1 Phillips screwdriver

## 7. GENERAL FEATURES (continues)

### Marking data:

Indelible marking

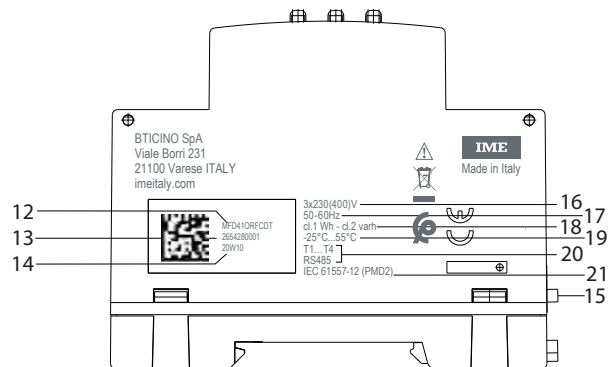
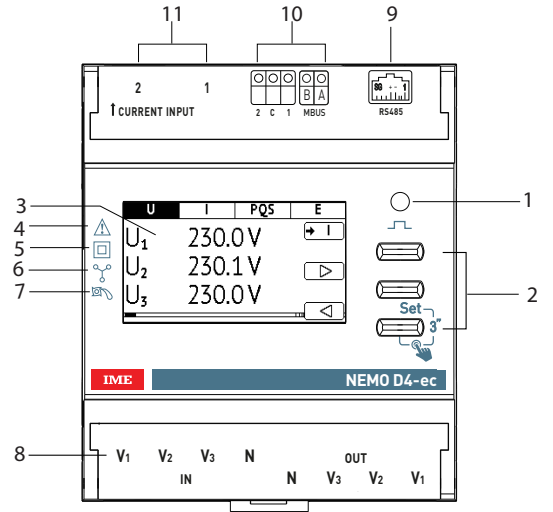

1. Metrological LED
2. Keypad with 3 multifunction pushbuttons
3. Graphic display
4. Consult the user manual before installation
5. Double insulation
6. Connection on 4-wire / 3-wire three-phase line
7. Anti-rotation device (anti-decreasing)
8. Voltages
9. RJ45 connection for Modbus RTU
10. Mbus communication and tariff input
11. 1 / 2 current input
12. Item code
13. Datamatrix for product traceability
14. Week and year of manufacture
15. Voltages
16. Rated voltages
17. Rated frequencies
18. Precision classes
19. Temperature of use
20. Inputs / Outputs
21. Reference standards

# Three-phase multifunction instrument with 1 or 2 "Easy Connect" inputs

Codes: MFD41ORFCDT – MFD42ORFCDT  
MFD41ORFCMT – MFD42ORFCMT

Model: NEMO D4-ec

## 7. GENERAL FEATURES

### Laser marking:

#### Left Side

Traceability information

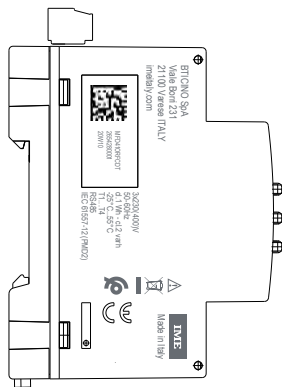

#### Right Side

Wiring diagrams

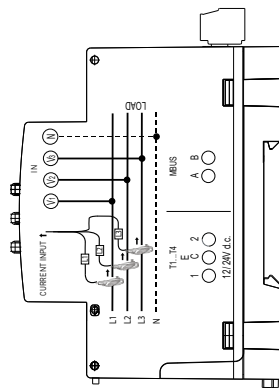
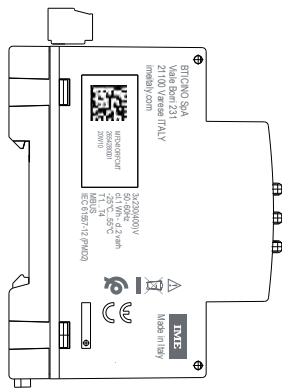
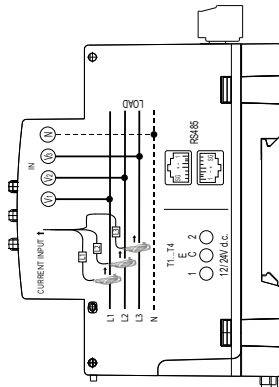

### Marking of communication outputs and tariff inputs:

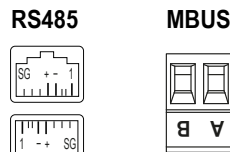
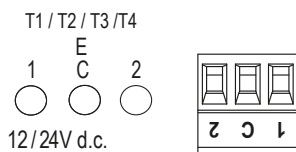

## 7. GENERAL FEATURES GENERALI (continues)

### Display and metrological LED:

- Graphic, backlit, 1.8 inches (256x128).

Rogowski inputs	Energy Resolution	Wh/imp.
630A	1kWh/kvarh/kVAh	10
1600A	1kWh/kvarh/kVAh	25
3200A	1kWh/kvarh/kVAh	50
6300A	0,01MWh/Mvarh/MVAh	100

### Display of the value and programming:

- By means of the front keypad, 3 pushbuttons (see the user manual).
- Access protected by identification code (**predefined code 1000**)

### Measurements and precision in conformity with EN/IEC 61557-12

- Current: cl.1
- Voltage: cl.0.5
- Frequency:  $\pm 0,1$  Hz
- Instantaneous total active power, phase, average value and max. average value: cl.1
- Instantaneous total reactive power, phase, average value and max. average value: cl.2
- Instantaneous total apparent power, phase, average value and max. average value: cl.1
- Power Factor: cl.1
- Total and partial active energy, tariff, phase, positive and negative cl.1
- Total and partial reactive energy, tariff, phase, positive and negative cl.2
- Apparent energy cl.1

The above classes are guaranteed by maintaining the centring, between Rogowski sensor and primary conductor, with the appropriate accessories provided and a harmonic content within the limits of the EN/IEC 61557-12 standard

### Harmonic analysis (THD): value and graphic

- Up to the 15th harmonic

### Average power:

- Measurement: apparent, reactive, active power
- Calculation: moving average, on the selected period
- Average time: 3/5/8/10/15/20/30/60min
- Load Profile (power load curve), diagram of the last 24 recorded average power values

### Average time set | Curve interval

3 min	72 min
5 min	2 hours
60 min	24 hours

### Resettable meter:

- Counting of operating hours and minutes
- 8-figure resolution (6 for the hours + 2 for the minutes)
- Maximum display: 999999.99
- Programmable value: 0...50% Pn (Positive active power)

# Three-phase multifunction instrument with 1 or 2 "Easy Connect" inputs

Codes: MFD41ORFCDT – MFD42ORFCDT  
MFD41ORFCMT – MFD42ORFCMT

Model: NEMO D4-ec

## 7. GENERAL FEATURES

### Digital input

- The digital input allows switching the energy counting on 4 tariffs
- 3 input terminals with common point (1 - C - 2)

Terminals	Without bush	Without bush
Rigid wire	0,05 + 1,5 mm <sup>2</sup>	0,05 + 2,5 mm <sup>2</sup>
Flexible wire	0,05 + 1,5 mm <sup>2</sup>	0,05 + 2,5 mm <sup>2</sup>

- Rated voltage: 12-24Vdc, 10mA Max.

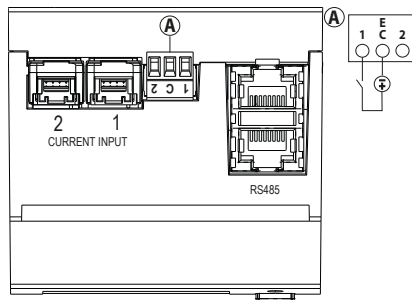

### Features of the ModBus communication port

- Programmable addresses: from 1 to 247 (5\*)
- Communication speed: 4.8 – 9.6 – 19.2\* – 38.4 kbps
- Parity bit: none, even\*, odd
- Stop bit: 1
- Galvanically isolated with respect to the measurement inputs
- Standard RS485 3 wires, Half-Duplex on RJ45 connector –
- Modbus® RTU protocol
- Response time: ≤ 200ms
- 120Ω terminating resistor inside the instrument (it can be set in the SETUP menu, default value: none\*)
- **MFD41ORFCDT**: Programmable address from 1 to 247
- **MFD42ORFCDT**: Programmable address from n = 1 to n = 246 for first input measurements and address n+1 (automatically assigned) for second input measurements

### Features of the MBus communication port:

- Standard: EN 13757
- Transmission: serial asynchronous
- No. of bit: 8
- Parity bit: fixed even
- Communication speed: 300-600-1.200-2.400\*-4.800-9.600bit/s
- No. of primary address: 0\*...250
- **MFD41ORFCMT / MFD42ORFCMT**: Programmable primary address from 0 to 250
- **MFD41ORFCMT / MFD42ORFCMT**: Programmable secondary address from 0 to 99999999
- Load MBus: 1
- Galvanically isolated with respect to the measurement inputs
- Transferred measurements: see communication protocol

### \* Factory data

## 7. GENERAL FEATURES

### Recommendations:

**For the device protection against overloads and short circuits, it is recommended to use a thermal-magnetic circuit breaker**

### Protection class:

- Protection index of terminals against direct contacts: IP 20 (IEC/EN 60529);
- Protection index of the front face against direct contacts: IP 54 (IEC/EN 60529);
- Class II: front panel with cover plate;
- Protection class against mechanical impacts IK03 (IEC/EN 62262)

### Resistance to vibrations:

- Vibration: from 5 to 150Hz width 0,15mm/1g
- Shock: 19g / 16msec

### Housing material:

BLEND >PC + ABS<;

Identification according to ISO 11469: >PC<;

GWFI IEC 60965-2-12 (§1.6mm): 850°C;

Flame rating UL 94 / IEC 60695\_11\_10 (1.6/3.2 mm): V2;

### Operating temperatures:

- Tmin. = - 20 °C; Tmax. = + 60 °C.

### Room storage temperatures:

- Tmin. = - 25 °C; Tmax. = + 70 °C

**Weight:** 0,270Kg

**Packaged volume:** 1.5 dm3.

**Room:** mechanical M1 – electric E2

## 8. CONFORMITY AND CERTIFICATIONS

### Insulation:

- Measurement categories: III (according to EN-61010)
- Level of pollution: 2
- Insulation voltage,  $U_i$ : 300V, Phase-Neutral

### Dielectric rigidity:

- Power supplies/ Outputs: 3kV / 50Hz / 1min
- Housing / Terminals: 4kV / 50Hz / 1min

### Pulse:

- Power supplies: 6.3kV / 1.2 – 50µsec / 0.5J

### In compliance with the standards:

- Precision class: Class 1 active energy (IEC/EN62053-21)
- Precision class: Class 2 reactive energy (IEC/EN62053-23)
- Electromagnetic compatibility: Tests in accordance with EN/IEC 62052-11 / EN 61326-1
- Precision class according to IEC/EN61557-12
- 2014/35/UE 2014/30/UE

### Respecting the environment – Conformity with the CEE directives:

- Compliance with the 2002/95/EC Directive, as modified by the 2015/863 Directive (RoHS 2), on the restriction of the use of certain hazardous substances in electrical and electronic equipment.
- Conformity with the REACH Regulation (1907/ 2006): at the date of publication of this document no substance in the annex XIV is found in these products.
- RAEE Directive (2012/19/EU: the sale of this product includes a contribution to the appointed environmental bodies of each European country in charge of handling, at the end of their life, the products falling within the scope of the EU Directive on Electric and Electronic Equipment Waste.

### Plastic materials:

- Plastic materials without Halogens.
- Part marking according to standards ISO 11469 and ISO 1043.

### Packaging:

- Packaging designed and produced in accordance with Decree 98-638 of 20/07/1998 and directive 94/62/CE."

# Three-phase multifunction instrument with 1 or 2 “Easy Connect” inputs

Codes: MFD41ORFCDT – MFD42ORFCDT  
 MFD41ORFCMT – MFD42ORFCMT  
 Model: NEMO D4-ec

## 9. COMMUNICATION

### RS485 Modbus wiring diagram:

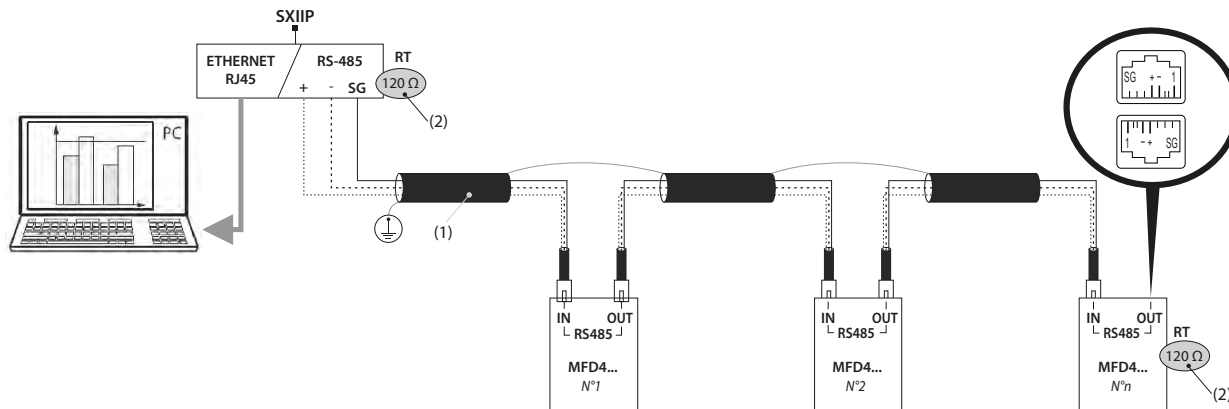

### RS485 Modbus wiring diagram with Mini Web Server:

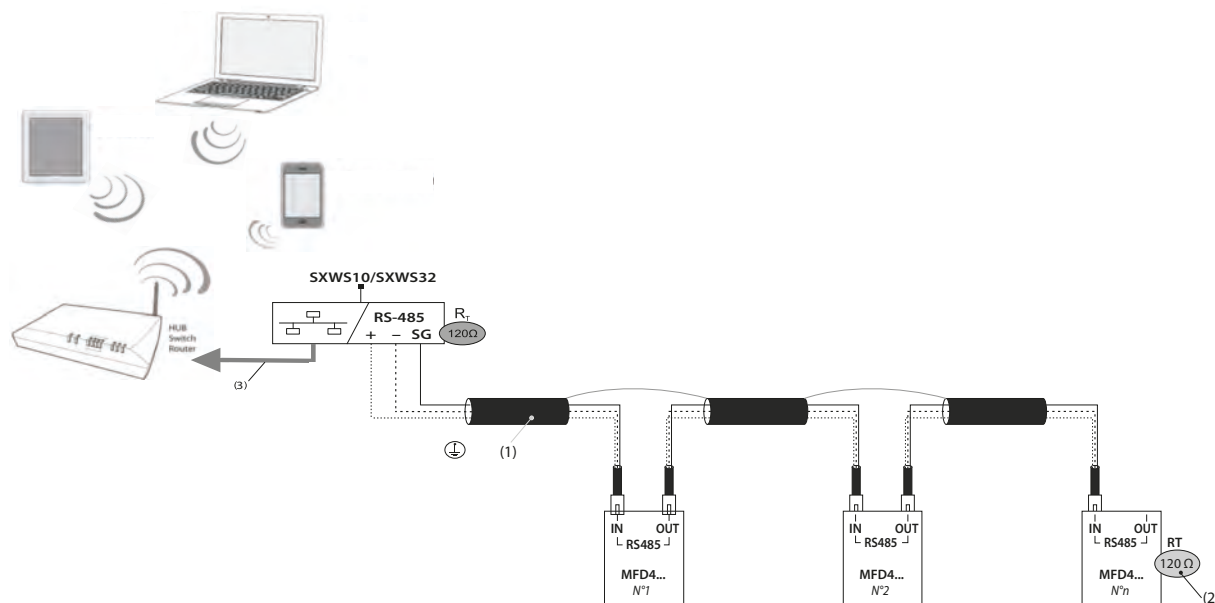

- (1) RS485: Required use of Belden 9842 or Belden 3106A wire (or equivalent) for a maximum bus length of 1000 m, or Category 6 wire (FTP or UTP) for a maximum length of 50 m
- (2) 120Ω terminating resistor inside the instrument
- (3) Ethernet: Cat. 6 (FTP/UTP)
- (4) The “SG” terminal must not be connected to the earth

### Mbus wiring diagram:

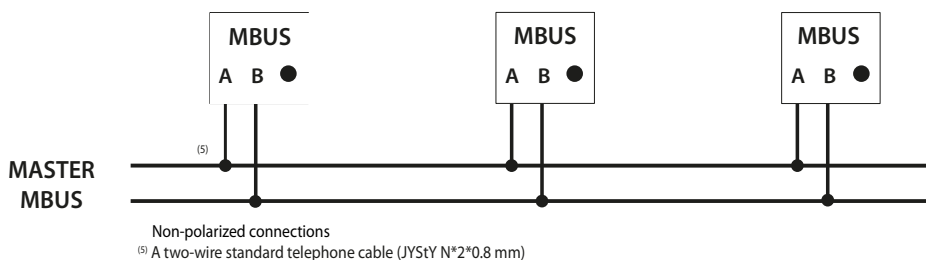

### Communication tables:

- The MODBUS and MBUS communication protocols are available on the <http://www.imeitaly.com> site

## Instrument multifonction triphasé à 1 ou 2 entrées « Easy Connect »

Codes: MFD41ORFCDT – MFD42ORFCDT  
MFD41ORFCMT – MFD42ORFCMT  
Modèle: NEMO D4-ec



ROG630M2	ROG1600M2	ROG3200M2	ROG6300M2
∅ 50mm	∅ 100mm	∅ 150mm	∅ 240mm



Sommaire	Pages
1. Utilisation .....	1
2. Gamme .....	1
3. Installation .....	1
4. Dimensions .....	1
5. Branchements .....	2
6. Données de fonctionnement.....	3
7. Caractéristiques générales.....	3
8. Conformité et certifications .....	5
9. Communication .....	6

### 1. UTILISATION

L'instrument multifonction, sur 4 modules DIN, est doté de connecteur rapide pour le branchement des trois capteurs de courant de type Rogowski (versions de 630A/ 1600A/ 3200A/ 6300A).  
L'instrument de mesure à 4 cadrans, adapté aux réseaux 3N-3E et 3-3E.

### 2. GAMME

Code Réf.	I Entrées	Sorties	Entrées Numeriques	Plage de la Tension
MFD41ORFCDT	1	Modbus	4 Tarifs	V-N/V-: 3x230/ 3x400±15%
MFD42ORFCDT	2			
MFD41ORFCMT	1	Mbus		
MFD42ORFCMT	2			

Code	Bobines Rogowski Ouvrantes				Longueur du câble (m)	Diamètre (mm)
	Entrée (A)	Courant min. (A)	Courant max. (A)			
ROG630M2	630	12,5	750	2	50	
ROG1600M2	1600	32,5	1950	2	100	
ROG3200M2	3200	65,0	3900	2	150	
ROG6300M2	6300	125,0	7500	2	240	
Code câble				Longueur du câble (m)	Quantité	
ROGEXTM1	-	-	-	1	x 3 max.	
ROGETXM3	-	-	-	3	x 1 max.	

### 3. INSTALLATION:

Sur rail symétrique EN/IEC 60715 ou guide DIN 35.

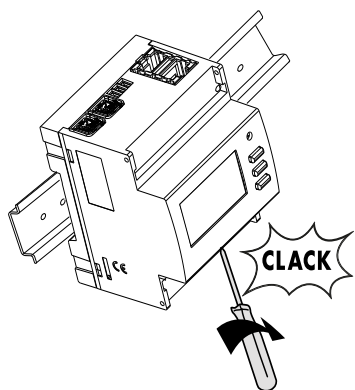

### Position de fonctionnement:

Verticale, horizontale, dessus/dessous, latérale



### 4. DIMENSIONS

Carter: 4 modules DIN43880

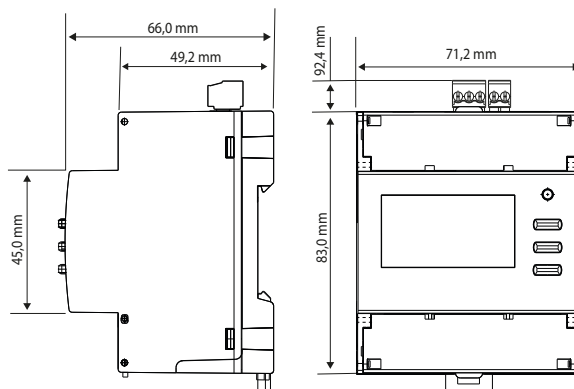

# Instrument multifonction triphasé à 1 ou 2 entrées « Easy Connect »

Codes: MFD41ORFCDT – MFD42ORFCDT  
MFD41ORFCMT – MFD42ORFCMT

Modèle: NEMO D4-ec

## 5. CONNEXIONS - BRANCHEMENT

### Schemi di inserzione:

- Réseau triphasé à 4 fils ou à 3 fils \*5P5G#5/5G+

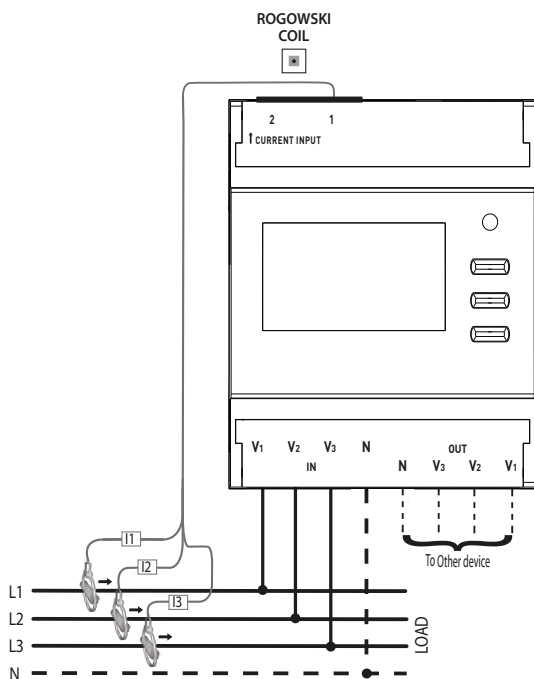

- Schéma avec 2 sondes:

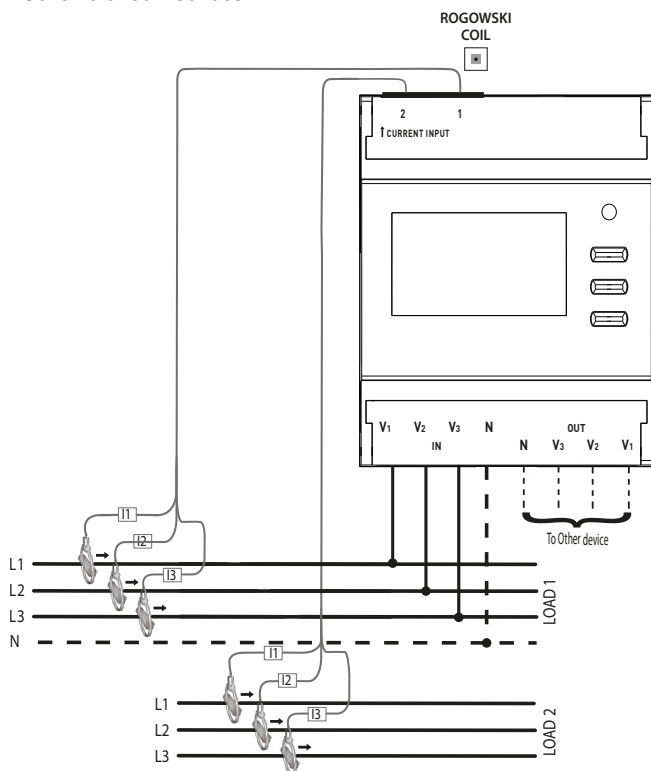

## 5. CONNEXIONS - BRANCHEMENT

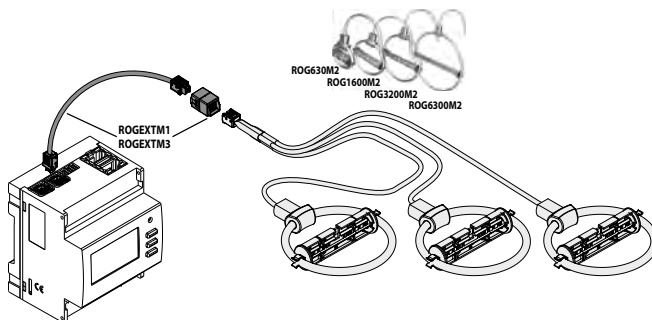

- Capteur Rogowski – Longueur du câble

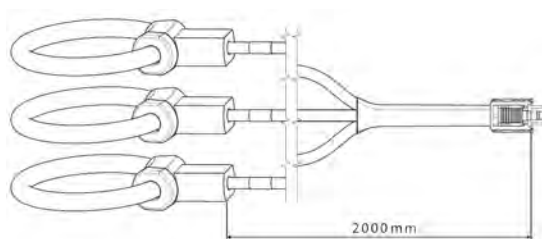

Cette longueur peut être étendue à l'aide du câble rallonge + connecteur jusqu'à 5 mètres (2 m de câble Rogowski et jusqu'à 3 m de câble rallonge)

- **ROGEXTM1, ROGEXTM3:**

Câble rallonge pour bobines Rogowski

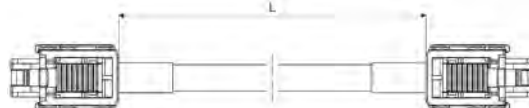

Code Réf.	Longueur (mm)
ROGEXTM1	1000
ROGEXTM3	3000

Support centreur en plastique pour bobines Rogowski

Code Réf.	Longueur (mm)
ROG630M2	79
ROG1600M2	123
ROG3200M2	173
ROG6300M2	263

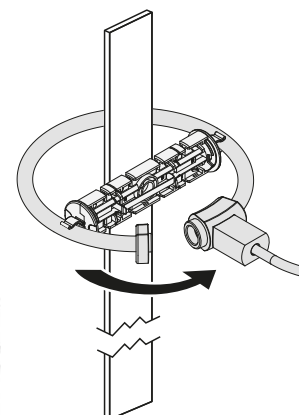
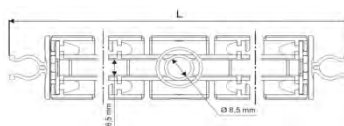



# Instrument multifonction triphasé à 1 ou 2 entrées « Easy Connect »

Codes: MFD41ORFCDT – MFD42ORFCDT  
MFD41ORFCMT – MFD42ORFCMT

Modèle: NEMO D4-ec

## 6. DONNÉES DE FONCTIONNEMENT

### 6.1 CARACTÉRISTIQUES ÉLECTRIQUES

Pour tous les codes MFD41ORFCDT – MFD42ORFCDT – MFD41ORFCMT - MFD42ORFCMT, la portée de référence (Iref) est programmable sur la base des sondes Rogowski choisies :

Portée des courants	I <sub>min</sub>	I <sub>ref</sub>	I <sub>max</sub>
630	12,5A	250A	750A
1600	32,5A	650A	1950A
3200	65A	1300A	3900A
6300	125A	2500A	7500A

#### Tensions V1,V2,V3,N:

- Tension triphasée: V-N/ V-V : 3x230 /3x400 ±15%
- V-V: 3x230 ±15%

#### Section maximale des câbles à brancher aux bornes V1,V2,V3,N:

Bornes	Sans douille	Avec douille
Câble rigide	0,05 + 1,5 mm <sup>2</sup>	0,05 + 2,5 mm <sup>2</sup>
Câble flexible	0,05 + 1,5 mm <sup>2</sup>	0,05 + 2,5 mm <sup>2</sup>

#### Auto-alimenté (bornes V et N) :

- Fréquence nominale : 50/60 Hz
- Fréquence de fonctionnement : 45...65Hz
- Auto-consommation ≤ 2,5VA"@230 Vca

#### Puissance thermique maximale dissipée pour le dimensionnement des tableaux : ≤ 5W

### 6.2 CARACTÉRISTIQUES MÉCANIQUES

#### Bornes à vis:

- Dimensions hors tout externes max. : 18 mm
- Longueur des dénudages du câble pour entrée et bus 5 mm; pour tensions in/out 7,5 mm

#### Tête de la vis:

- Bornes de branchement des tensions (V1, V2, V3 et N) à vis COMBI (tête fendu/cruciforme PH1) ; pour bornes N, V3, V2 et V1: vis à tête fendue.
- Borniers sur la partie supérieure du multifonction (entrée et bus): vis à tête fendue.

#### Couple de serrage recommandé:

- Bornes de branchement des tensions (V1, V2, V3, N) : 0,5 Nm
- Bornes de branchement des tensions (N, V3, V2, V1) : 0,5 Nm
- Borniers tarifs et communication (Modbus ou Mbus) : 0,2 Nm

#### Outils nécessaires:

- Pour les bornes version BUS, utiliser un tournevis à tête plate de 2,5 mm; pour les bornes de tension, utiliser un tournevis à tête plate de 3,5 mm et/ou cruciforme PH1

## 7. CARACTÉRISTIQUES GÉNÉRALES (.../...)

### Données de marquage:

Marquage indélébile

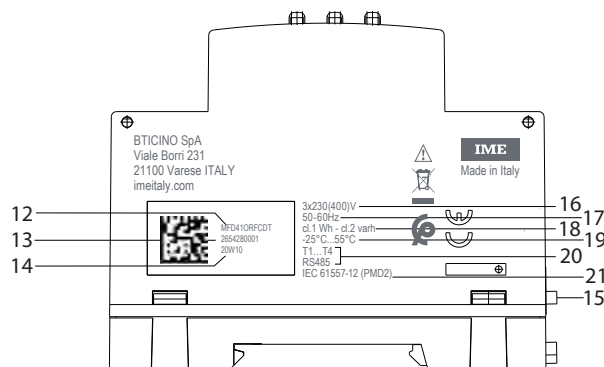
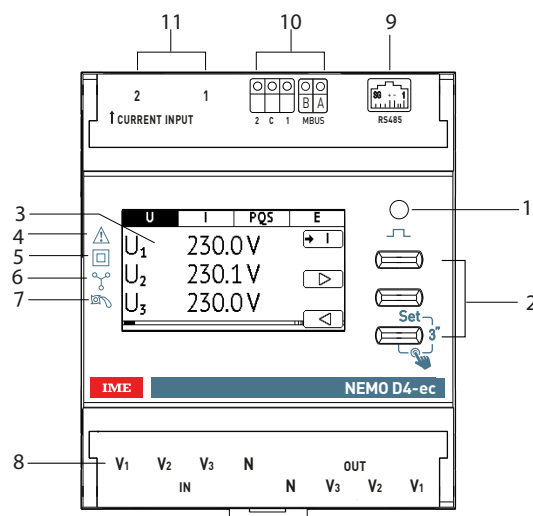

1. VOYANT métrologique
2. Clavier à 3 boutons multifonction
3. Écran graphique
4. Consulter le manuel d'utilisation avant de procéder à l'installation
5. Double isolation
6. Activation sur ligne triphasés 4 fils / 3 fils
7. Dispositif anti-rotation (anti-diminution)
8. Tensions
9. Connexion RJ45 pour Modbus RTU
10. Communication Mbus et entrée tarifs
11. Entrée courants 1 / 2
12. Code référence
13. Datamatrix pour traçabilité produit
14. Semaine et année de fabrication
15. Tensions
16. Tensions nominales
17. Fréquences nominales
18. Classes de précision
19. Température d'utilisation
20. Entrées / Sorties
21. Normes de référence

# Instrument multifonction triphasé à 1 ou 2 entrées « Easy Connect »

Codes: MFD41ORFCDT – MFD42ORFCDT  
MFD41ORFCMT – MFD42ORFCMT

Modèle: NEMO D4-ec

## 7. CARACTÉRISTIQUES GÉNÉRALES

### Marquage au laser:

#### Côté Gauche

Informations de traçabilité

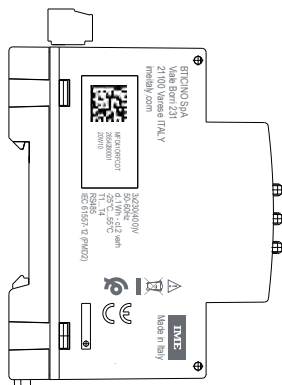

#### Côté Droit

Schémas de branchement

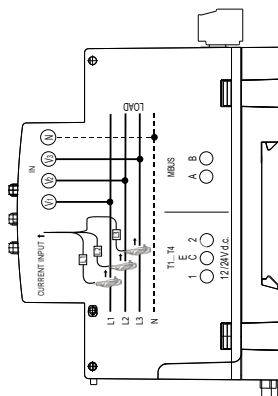
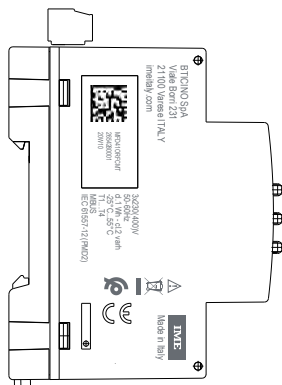
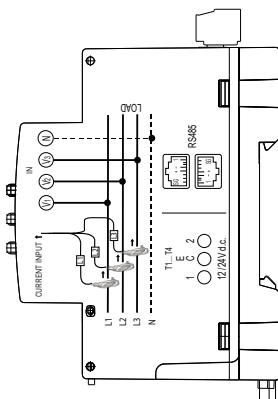

### Marquages sorties communication et entrée tarifs:

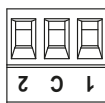
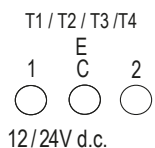

#### RS485



#### MBUS



## 7. CARACTÉRISTIQUES GÉNÉRALES (.../...)

### Écran et VOYANT métrologique:

- Graphique à rétroéclairage 1,8 pouces (256x128).

Entrées Rogowski	Précision énergies	Wh/imp.
630A	1kWh/kvarh/kVAh	10
1600A	1kWh/kvarh/kVAh	25
3200A	1kWh/kvarh/kVAh	50
6300A	0,01MWh/Mvarh/MVAh	100

### Visualisation de la valeur et programmation:

- Avec le clavier frontal, 3 boutons (voir le manuel utilisateur).
- Accès protégé par un code d'identification (**code prédéfini :1000**)

### Grandeurs mesurées et précision conformes à la norme EN/IEC 61557-12

- Courant: cl.1
- Tension: cl.0,5
- Fréquence:  $\pm 0,1$  Hz
- Puissance totale active instantanée, phase, valeur moyenne et valeur moyenne max.: cl.1
- Puissance totale réactive, phase, valeur moyenne et valeur moyenne max.: cl.2
- Puissance totale apparente instantanée, phase, valeur moyenne et valeur moyenne max.: cl.1
- Facteur de puissance: cl.1
- Énergie active totale et partielle, tarifs, de phase, positive et négative cl. 1
- Énergie réactive totale et partielle, tarifs, de phase, positive et négative cl. 2
- Énergie apparente. cl.1

Les classes susmentionnées sont garanties en maintenant le centrage, entre capteur Rogowski et conducteur primaire, avec les accessoires fournis et un harmonique maintenu dans les limites de la norme EN/IEC 61557-12.

### Analyse harmonique (THD): valeur et graphique

- Jusqu'à la 15<sup>ème</sup> harmonique

### Puissance moyenne:

- Grandeur: puissance active, réactive, apparente
- Calcul: moyenne mobile, sur la période sélectionnée
- Temps moyen: 3/5/8/10/15/20/30/60 min
- Load Profile (courbe de charge de puissance), diagramme des 24 dernières valeurs de puissance moyenne enregistrées:

#### Temps de moyenne programmé | Intervalle de la courbe

3 min	72 min
5 min	2 heures
60 min	24 heures

### Totalisateur pouvant être remis à zéro :

- Décompte heures et minutes de fonctionnement
- Résolution 8 chiffres (6 pour les heures + 2 pour les minutes)
- Visualisation maximum : 999999.99
- Valeur programmable : 0...50% Pn (Puissance active positive)

# Instrument multifonction triphasé à 1 ou 2 entrées « Easy Connect »

Codes: MFD41ORFCDT – MFD42ORFCDT  
MFD41ORFCMT – MFD42ORFCMT

Modèle: NEMO D4-ec

## 7. CARACTÉRISTIQUES GÉNÉRALES

### Entrée numérique

- L'entrée numérique permet la commutation du décompte de l'énergie sur 4 tarifs.
- 3 bornes d'entrée avec point commun (1 - C - 2)

Bornes	Sans douille	Avec douille
Câble rigide	0,05 + 1,5 mm <sup>2</sup>	0,05 + 2,5 mm <sup>2</sup>
Câble flexible	0,05 + 1,5 mm <sup>2</sup>	0,05 + 2,5 mm <sup>2</sup>

- Tension nominale : 12-24 Vcc, 10mA Max.

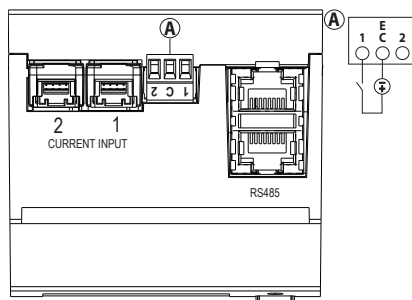

### Caractéristiques du port de communication ModBus:

- Adresses programmables : de 1 à 247 (5\*)
- Vitesse de communication : 4,8 – 9,6 – 19,2\* – 38,4 kbps
- Bit de parité : aucune parité, paire\*, impaire
- Bit de stop : 1
- A isolation galvanique par rapport aux autres entrées de mesure
- Standard RS485 3 fils, Half-Duplex, sur connecteur RJ45
- Protocole Modbus® RTU
- Temps de réponse : ≤ 200 ms
- Résistance de terminaison de 120 Ω intégrée à l'instrument (réglable dans le menu de RÉGLAGE, valeur par défaut « none »\*)
- **MFD41ORFCDT**: Adresse programmable de 1 à 247
- **MFD42ORFCDT**: Adresse programmable de n = 1 à n = 246 pour des mesures de première entrée et adresse n+1 (attribuée automatiquement) pour mesures sur deuxième entrée

### Caractéristiques du port de communication MBus:

- Standard : EN 13757
- Transmission : asynchrone série
- N°-bit : 8
- Bit de parité : paire\*, fixe
- Vitesse de communication: 300-600-1.200-2.400\*-4.800-9.600 bit/s
- N° adresse primaire : 0\*...250
- **MFD41ORFCMT / MFD42ORFCMT**: Adresse programmable de 0 à 250
- **MFD41ORFCMT / MFD42ORFCMT**: Adresse secondaire programmable de 0 à 99999999
- Load MBus : 1
- A isolation galvanique par rapport aux autres entrées de mesure
- Mesures transférées : voir protocole de communication

\* Données par défaut

## 7. CARACTÉRISTIQUES GÉNÉRALES

### Recommandations :

**Pour la protection du dispositif contre les surcharges et les courts-circuits, il est recommandé d'utiliser un interrupteur magnétothermique.**

### Classe de protection:

- Indice de protection des bornes contre les contacts directs: IP 20 (IEC/EN 60529) ;
- Indice de protection de la face frontale contre les contacts directs: IP 54 (IEC/EN 60529);
- Classe II : panneau frontal avec plaque ;
- Classe de protection contre les impacts mécaniques IK03 (IEC/EN 62262)

### Résistance aux vibrations:

- Vibration : de 5 à 150 Hz amplitude 0,15 mm/1 g
- Choc : 19 g / 16 msec

### Matériau habillage:

BLEND >PC + ABS<;

Identification conformément à ISO 11469: >PC<;

GWFI IEC 60965-2-12 (§1.6mm): 850°C;

Classification de la réaction aux flammes UL 94 / IEC 60695\_11\_10 (1.6/3.2 mm): V2;

### Température ambiante de fonctionnement:

- Tmin. = - 20 °C; Tmax. = + 60 °C

### Température ambiante de stockage:

- Tmin. = - 25 °C; Tmax. = + 70 °C

Poids: 0,270Kg

Volume emballé: 1,5 dm<sup>3</sup>

Environnement: mécanique M1 - électrique E2

## Instrument multifonction triphasé à 1 ou 2 entrées « Easy Connect »

Codes: MFD41ORFCDT – MFD42ORFCDT  
MFD41ORFCMT – MFD42ORFCMT

Modèle: NEMO D4-ec

### 8. CONFORMITÉ ET CERTIFICATIONS

#### Isolation:

- Catégories de mesure: III (conformément à EN-61010)
- Degré de pollution: 2
- Tension d'isolation,  $U_i$ : 300 V Phase-Neutre

#### Rigidité diélectrique:

- Alimentation / Sorties: 3 kV / 50 Hz / 1 min
- Habillage / Terminaisons: 4 kV / 50 Hz / 1 min

#### Impulsion:

- Alimentations: 6,3 kV / 1,2 – 50  $\mu$ sec / 0,5 J

#### Conformité aux normes:

- Classe de précision: Énergie active classe 1 (IEC/EN62053-21)
- Classe de précision: Énergie réactive classe 2 (IEC/EN62053-23)
- Compatibilité électromagnétique: Essais conformément à la norme EN/IEC 62052-11 / EN 61326-1
- Classe de précision conforme à la norme IEC/EN61557-12
- 2014/35/UE 2014/30/UE

#### Respect de l'environnement - Conformité aux directives CEE:

- Conformité à la directive 2011/65/UE modifiée par la directive 2015/863 (RoHS 2) relative aux limitations imposées à l'utilisation de certaines substances dangereuses dans les équipements électriques et électroniques.
- Conformité au règlement REACH (1907/2006) : à la date de publication du présent document, aucune substance mentionnée dans l'annexe XIV n'est présente dans les produits.
- Directive DEEE (2012/19/EU) : la commercialisation du produit prévoit une contribution aux organismes écologiques en charge, dans chaque pays européen, de la gestion de la fin du cycle de vie des produits qui rentrent dans le champ d'application de la Directive européenne sur les déchets d'équipements électriques et électroniques.

#### Matériaux plastiques:

- Matériaux plastiques sans halogènes.
- Marquage des parties conforme aux normes ISO 11469 et ISO 1043.

#### Emballages:

- Conception et production des emballages conformes au Décret 98-638 du 20/07/1998 et à la directive 94/62/CE.

# Instrument multifonction triphasé à 1 ou 2 entrées « Easy Connect »

Codes: MFD41ORFCDT – MFD42ORFCDT  
MFD41ORFCMT – MFD42ORFCMT  
Modèle: NEMO D4-ec

## 9. COMMUNICATION

### Schéma de branchement RS485 Modbus

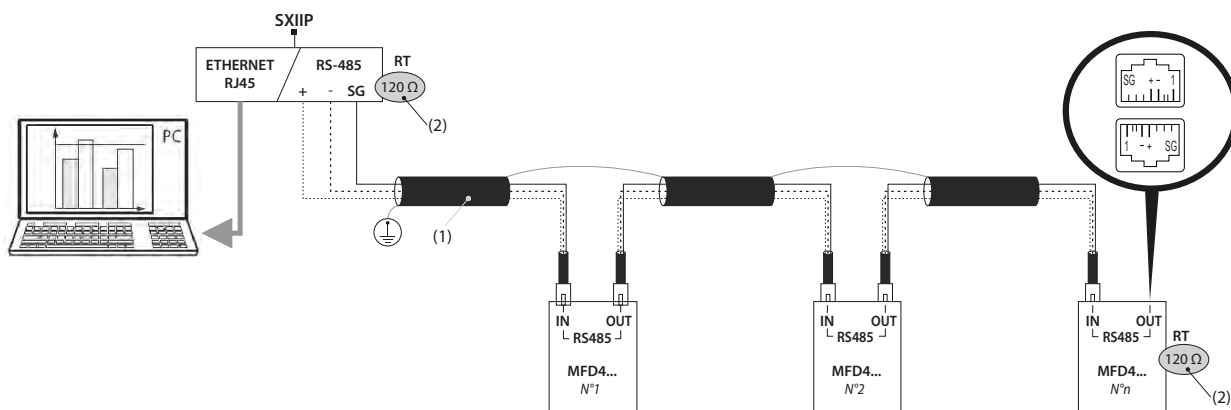

### Schéma de branchement RS485 Modbus avec Mini Web Serveur:

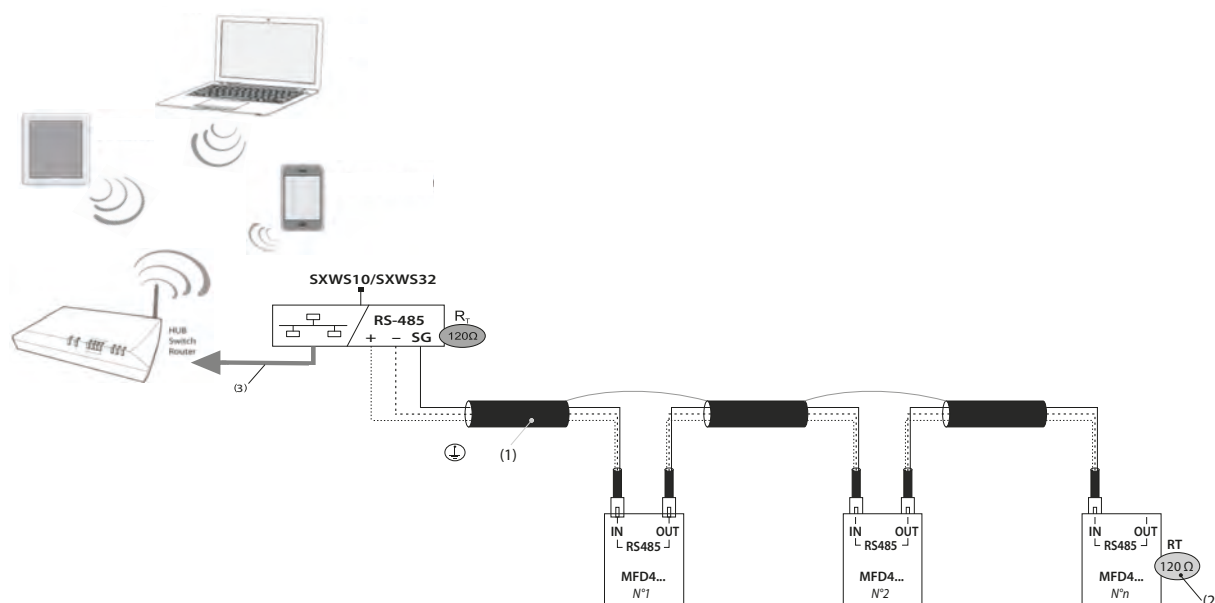

- (1) RS485: Utilisation prescrite de câble Belden 9842, Belden 3106A (ou équivalent) pour une longueur maximum du bus de 1000 m ou de câble de Catégorie 6 (FTP ou UTP) pour une longueur maximum de 50 m.
- (2) Résistance de terminaison de 120 Ω intégrée à l'instrument
- (3) Ethernet: Cat. 6 (FTP/UTP)
- (4) La borne « SG » ne doit pas être branchée à la terre.

### Schéma de branchement Mbus:

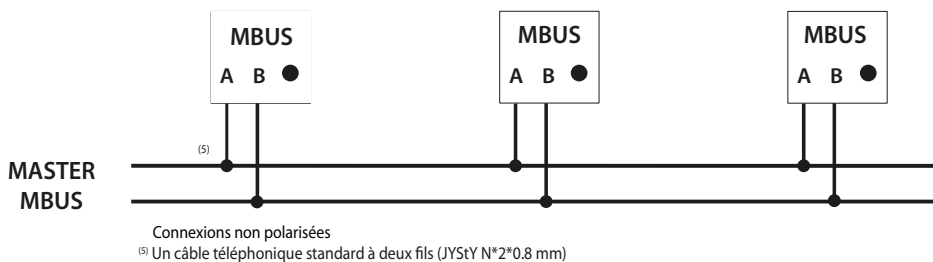

### Tableaux de communication

- Les protocoles de communication MODBUS et MBUS sont disponibles sur le site <http://www.imeitaly.com>

## Multifunktionsgerät mit 1 oder 2 "Easy Connect"-Eingängen

Codes: MFD41ORFCDT – MFD42ORFCDT  
MFD41ORFCMT – MFD42ORFCMT  
Modell: NEMO D4-ec



ROG630M2	ROG1600M2	ROG3200M2	ROG6300M2
∅ 50mm	∅ 100mm	∅ 150mm	∅ 240mm



### Inhaltsverzeichnis

### Seiten

1. Gebrauch .....	1
2. Baureihe .....	1
3. Installation .....	1
4. Abmessungen.....	1
5. Verbindungen .....	2
6. Betriebsdaten .....	3
7. Allgemeine Eigenschaften.....	3
8. Konformität und Zertifizierungen.....	5
9. Kommunikation.....	6

## 1. GEBRAUCH

Das Multifunktionsgerät mit 4 DIN-Modulen ist mit einem Schnellanschluss zum Anschließen der drei Stromsensoren vom Typ Rogowski (Versionen 630A/ 1600A/ 3200A/ 6300A) ausgestattet. Das Instrument misst in 4 Quadranten, es eignet sich für 3N-3E- und 3-3ENetzwerke.

## 2. BAUREIHE

Artikelcode	Eingänge I	Ausgang	Digitaleingänge	Spannungsbereich
MFD41ORFCDT	1	Modbus	4 Tarife	V-N/V-V: 3x230/ 3x400±15% V-V: 3x230 ±15%
MFD42ORFCDT	2			
MFD41ORFCMT	1	Mbus		
MFD42ORFCMT	2			

Code	Aufmachbare Rogowski Spulen				Länge des Kabels (m)	Durchmesser (mm)
	Eingang (A)	Mindeststrom (A)	Maximalstrom (A)			
ROG630M2	630	12,5	750	2	50	
ROG1600M2	1600	32,5	1950	2	100	
ROG3200M2	3200	65,0	3900	2	150	
ROG6300M2	6300	125,0	7500	2	240	
Kabelcode				Länge des Kabels (m)	Menge	
ROGETM1	-	-	-	1	x 3 max.	
ROGETM3	-	-	-	3	x 1 max.	

## 3. INSTALLATION

### Schraubenbefestigung:

An einer EN/IEC 60715 symmetrischen Schiene oder DIN 35 Schiene.

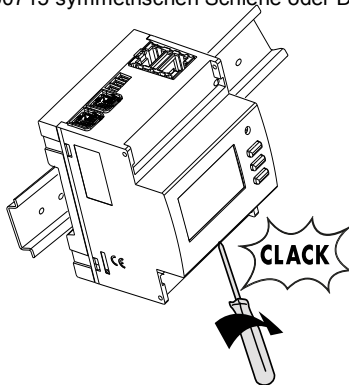

### Betriebsposition:

Vertikal, horizontal, umgedreht, an der Seite

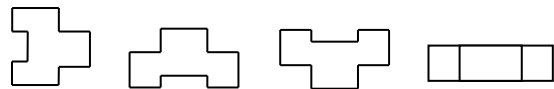

## 4. ABMESSUNGEN

Gehäuse: 4 Module DIN 43880

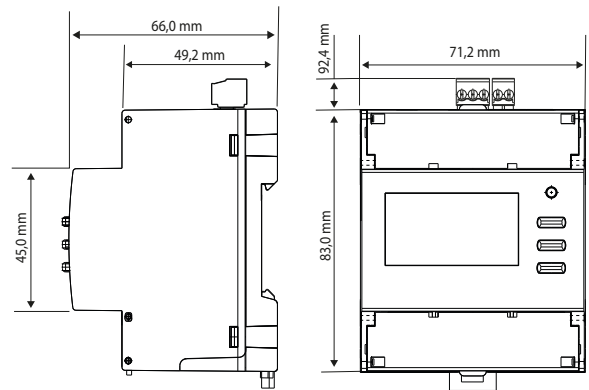

# Multifunktionsgerät mit 1 oder 2 "Easy Connect"-Eingängen

Codes: MFD41ORFCDT – MFD42ORFCDT  
MFD41ORFCMT – MFD42ORFCMT

Modell: NEMO D4-ec

## 5. VERBINDUNGEN - ANSCHLUSS

### Anschlussbilder:

- Drehstromnetz 3 oder 4 Leiter (3N3E; 3-3N), 3 Rogowski:

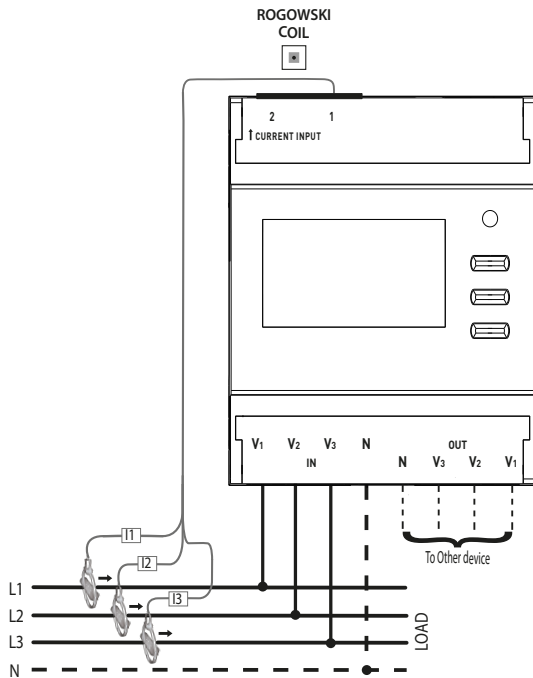

- Schema mit 2 Sonden

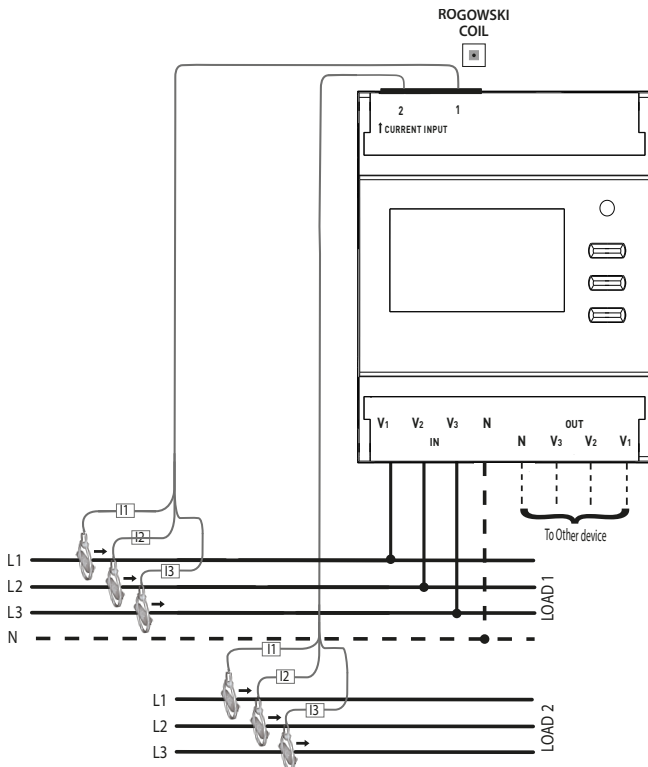

## 5. VERBINDUNGEN - ANSCHLUSS

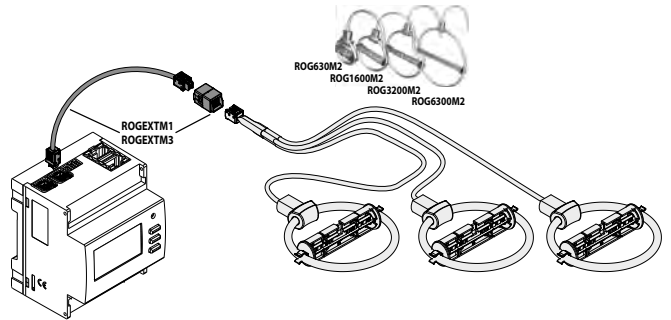

- Rogowski-Sensor – Kabellänge

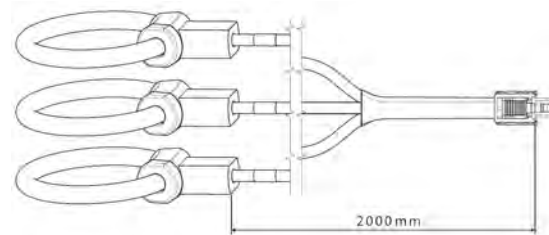

Diese Länge kann mit dem Verlängerungskabel + Stecker auf bis zu 5 Meter verlängert werden (2m Rogowski-Kabel und bis zu 3m Verlängerungskabel).

- ROGEXTM1, ROGEXTM3:

Verlängerungskabel für Rogowski-Spulen

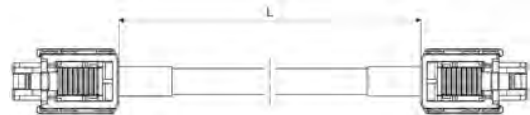

Artikelcode	Länge (mm)
ROGEXTM1	1000
ROGEXTM3	3000

Zentrierstück aus Kunststoff für Rogowski-Spulen

Artikelcode	Länge (mm)
ROG630M2	79
ROG1600M2	123
ROG3200M2	173
ROG6300M2	263

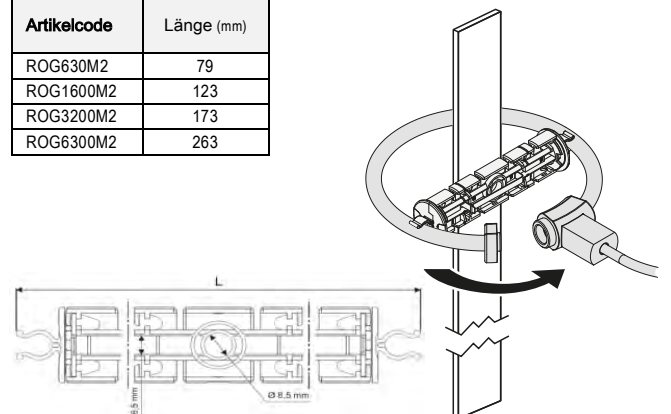

# Multifunktionsgerät mit 1 oder 2 "Easy Connect"-Eingängen

Codes: MFD41ORFCDT – MFD42ORFCDT  
MFD41ORFCMT – MFD42ORFCMT

Modell: NEMO D4-ec

## 6. BETRIEBSDATEN

### 6.1 STROMDATEN

Für alle Codes MFD41ORFCDT – MFD42ORFCDT – MFD41ORFCMT - MFD42ORFCMT ist die Bezugsleistung (Iref) entsprechend den gewählten Rogowski Einstellungen:

Stromleistung	I <sub>min</sub>	I <sub>ref</sub>	I <sub>max</sub>
630	12,5A	250A	750A
1600	32,5A	650A	1950A
3200	65A	1300A	3900A
6300	125A	2500A	7500A

### Spannungen V1,V2,V3,N:

- Dreiphasige Spannung : V-N/ V-V : 3x230 /3x400 ±15%
- V-V: 3x230 ±15%

Maximaler Schnitt der an die Klemmen (V1, V2, V3, N) anschließbaren Kabeln:

Klemmen	Ohne Hülse	Mit Hülse
Steifes Kabel	0,05 + 1,5 mm <sup>2</sup>	0,05 + 2,5 mm <sup>2</sup>
Flexibles Kabel	0,05 + 1,5 mm <sup>2</sup>	0,05 + 2,5 mm <sup>2</sup>

### Selbstversorgung (Klemmen V und N):

- Nennfrequenz: 50/60Hz
- Arbeitsfrequenz: 47...63Hz
- Eigenverbrauch: ≤ 2,5VA @230 Vca

Maximale Verlustleistung für die thermische Dimensionierung der Schaltschränke: ≤ 5W

## 6.2 MECHANIK

### Schraubklemmen:

- Max. Außenmaß: 18mm
- Absolierlängen des Kabels für Eingang und Bus 5mm; für Ein-/Aus-Spannungen 7,5mm

### Schraubenkopf:

- Spannungsanschlussklemmen (V1, V2, V3, N) COMBI-Schrauben (Schlitzkopf PH1); für Klemmen (N, V3, V2, V1): Schlitzschrauben.
- Klemmleisten oben am Multifunktionsgerät (Eingang und Bus): Schlitzschrauben

### Empfohlenes Anzugsmoment:

- Spannungsanschlussklemmen (V1, V2, V3, N): 0,5Nm
- Spannungsanschlussklemmen (N, V3, V2, V1): 0,5Nm
- Tarif- und Kommunikationsklemmleisten (Modbus oder Mbus): 0,2 Nm

### Erforderliche Werkzeuge:

- Für Klemmen der BUS-Version verwenden Sie einen 2,5-mm-Schlitzschraubendreher; für Spannungsklemmen verwenden Sie einen 3,5-mm-Schlitzschraubendreher und/oder einen Kreuzschlitzschraubendreher PH1

## 7. ALLGEMEINE EIGENSCHAFTEN (Fortsetzung)

### Kennzeichnungsdaten:

Unlöschrare Markierung

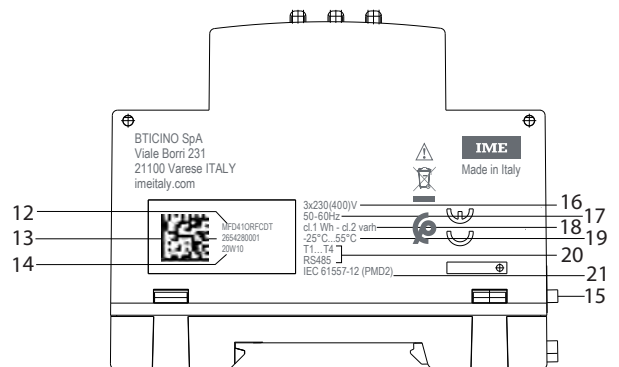
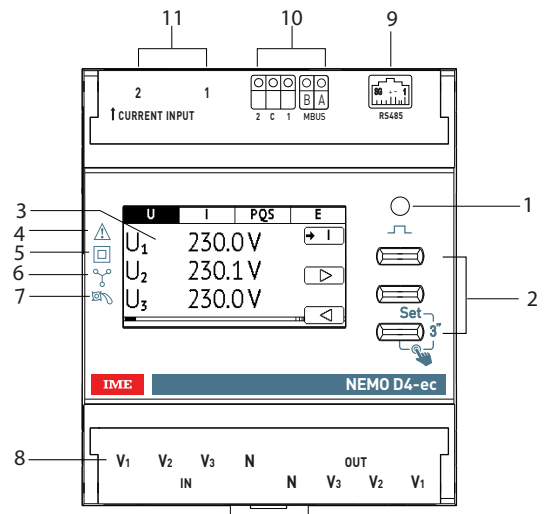

1. Metrologie LED
2. Tastatur bestehend aus 3 Multifunktionstasten
3. Graphisches Display
4. Bitte lesen das Handbuch bevor den Einbau
5. Doppelisolierung
6. Drehstromleitung 4 Leiter / 3 Leiter
7. Verdrehsicherung (Anti-Verringerung)
8. Spannungen
9. Anschluss RJ45 für ModBus RTU
10. Mbus-Kommunikation und Tarifeingang
11. Stromeingang 1 / 2
12. Artikelcode
13. Datamatrix für die Verfolgbarkeit des Produkts
14. Woche und Herstellungsjahr
15. Spannungen
16. Nennspannungen
17. Nennfrequenzen
18. Genauigkeitsklasse
19. Betriebstemperatur
20. Ein- / Ausgänge
21. Bezugsnormen





## Multifunktionsgerät mit 1 oder 2 "Easy Connect"-Eingängen

Codes: MFD41ORFCDT – MFD42ORFCDT  
MFD41ORFCMT – MFD42ORFCMT

Modell: NEMO D4-ec

### 7. ALLGEMEINE EIGENSCHAFTEN

#### Digitaleingang

- Der Digitaleingang ermöglicht die Umschaltung der Energiezählung auf 4 Tarife
- 3 Eingangsklemmen mit gemeinsamem Punkt (1 - C - 2)

Klemmen	Ohne Hülse	Mit Hülse
Steifes Kabel	0,05 + 1,5 mm <sup>2</sup>	0,05 + 2,5 mm <sup>2</sup>
Flexibles Kabel	0,05 + 1,5 mm <sup>2</sup>	0,05 + 2,5 mm <sup>2</sup>

Nennleistung: 12-24Vdc, 10mA Max.

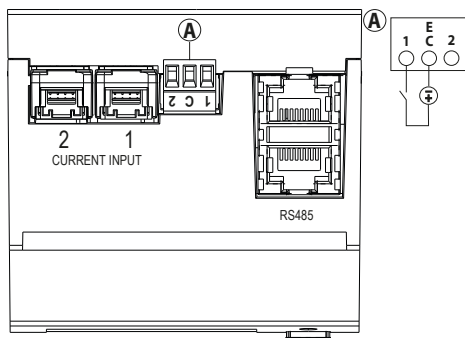

#### Eigenschaften des ModBus-Kommunikationsanschlusses:

- Programmierbare Adressen: 1 bis 247 (5\*)
- Kommunikationsgeschwindigkeit: 4,8 – 9,6 – 19,2\* – 38,4 kbps
- Paritätsbit: kein, gerade\*, ungerade
- Stoppbit: 1
- Galvanisch getrennt von Messeingängen
- Standard RS485 3-Draht, Half - Duplex Schnittstelle, am Anschluss RJ45
- Modbus® RTU Protokoll
- Ansprechzeit: ≤ 200ms
- 120Ω Abschlusswiderstand intern im Gerät (einstellbar über das SETUP-Menü, Default none\*)
- **MFD41ORFCDT**: Programmierbare Adresse von 1 bis 247
- **MFD42ORFCDT**: Programmierbare Adresse von n = 1 bis n = 246 für erste Eingangsmessungen und n+1 Adresse (automatisch vergeben) für zweite Eingangsmessungen

#### Eigenschaften des MBus-Kommunikationsanschlusses:

- Standard: EN 13757
- Übertragung: asynchron seriell
- Anzahl bit: 8
- Paritätsbit: kein, gerade fix
- Kommunikationsgeschwindigkeit: 300-600-1.200-2.400\*-4.800-9.600bit/s
- Nr. Primäradresse: 0\*...250
- **MFD41ORFCMT / MFD42ORFCMT**: Programmierbare Primäradresse von 0 bis 250
- **MFD41ORFCMT / MFD42ORFCMT**: Programmierbare Sekundäradresse von 0 bis 99999999
- Load MBus: 1
- Galvanisch getrennt von Messeingängen
- Übertragene Maße: siehe Kommunikationsprotokoll

#### \* Werkdaten

### 7. ALLGEMEINE EIGENSCHAFTEN

#### Empfehlungen:

**Zum Schutz des Gerätes vor Überlast und Kurzschluss empfehlen wir den Einsatz eines thermisch-magnetischen Schutzschalters.**

#### Schutzklasse:

- Schutzklasse der Klemmen gegen direkte Berührung: IP 20 (IEC/EN 60529);
- Frontalschutzindex gegen direkte Berührung: IP 54 (IEC/EN 60529);
- Klasse II: Fronttafel mit Platte.
- Schutzklasse gegen mechanische Stöße IK03 (IEC/EN 62262)

#### Vibrationsfestigkeit:

- Vibration: 5 bis 150Hz Amplitude 0,15mm/1g
- Schock: 19g / 16msec

#### Gehäusematerial:

BLEND>PC + ABS<;  
Kennzeichnung nach ISO 11469: >PC <;  
GWFI IEC 60965-2-12 (§1.6mm): 850°C;  
Brennbarkeitsklasse UL 94 / IEC 60695\_11\_10 (1,6/3,2 mm): V0;

#### Betriebstemperatur:

- Tmin. = - 20 °C; Tmax. = + 60 °C.

#### Lagertemperatur:

- Tmin. = - 25 °C; Tmax. = + 70 °C

**Gewicht:** 0,270Kg

**Volumen, verpackt:** 1,5 dm<sup>3</sup>.

**Umgebung:** mechanisch M1 - elektrisch E2

## Multifunktionsgerät mit 1 oder 2 "Easy Connect"-Eingängen

Codes: MFD41ORFCDT – MFD42ORFCDT  
MFD41ORFCMT – MFD42ORFCMT

Modell: NEMO D4-ec

### 8. KONFORMITÄT UND ZERTIFIZIERUNGEN

#### Isolation:

- Messkategorie: III (je nach EN-61010)
- Verschmutzungsgrad: 2
- Isolationsspannung,  $U_i$ : 300V, Phase-Nullleiter

#### Durchschlagfestigkeit:

- Speisung / Ausgänge: 3kV / 50Hz / 1min
- Gehäuse/Klemmen: 4kV / 50Hz / 1min

#### Impuls:

- Speisung: 6.3kV / 1,2 – 50µsec / 0,5J

#### Konform nach Normen:

- Genauigkeitsklasse: Wirkenergie Klasse 1 (EN/IEC 62053-21)
- Genauigkeitsklasse: Blindenergie Klasse 2 (EN/IEC 62053-23)
- Elektromagnetische Verträglichkeit: Prüfungen gemäß EN/IEC 62052-11 / EN 61326-1
- Genauigkeitsklasse gemäß IEC/EN61557-12
- 2014/35/UE 2014/30/UE

#### Umweltschutz - Konform nach den EWG-Richtlinien:

- Einhaltung der Richtlinie 2011/65 / EU in der durch die Richtlinie 2015/863 (RoHS 2) geänderten Fassung hinsichtlich der Beschränkungen der Verwendung einiger gefährlicher Stoffe in Elektro- und Elektronikgeräten
  - Konform mit der REACH-Verordnung (1907/2006): Zum Zeitpunkt der Veröffentlichung dieses Dokuments ist kein in Anhang XIV enthaltener Stoff in diesen Produkten enthalten.
- WEEE-Richtlinie (2012/19 / EU): Die Vermarktung dieses Produkts liefert einen Beitrag an die Umweltorganisationen in jedem europäischen Land, die für die Entsorgung der Altgeräte verantwortlich sind, die in den Geltungsbereich der europäischen Richtlinie über Elektro- und Elektronik-Altgeräte fallen.

#### Kunststoffe:

- Halogenfreie Kunststoffe.
- Kennzeichnung von Teilen nach ISO 11469 und ISO 1043.

#### Verpackungen:

Gestaltung und Herstellung von Verpackungen gemäß Dekret 98-638 vom 20/07/1998 und Richtlinie 94/62/EG

**Multifunktionsgerät mit 1 oder 2  
“Easy Connect“-Eingängen**

Codes: MFD41ORFCDT – MFD42ORFCDT  
MFD41ORFCMT – MFD42ORFCMT  
Modell: NEMO D4-ec

**9. KOMMUNIKATION**

**Anschlussbilder RS485 Modbus:**

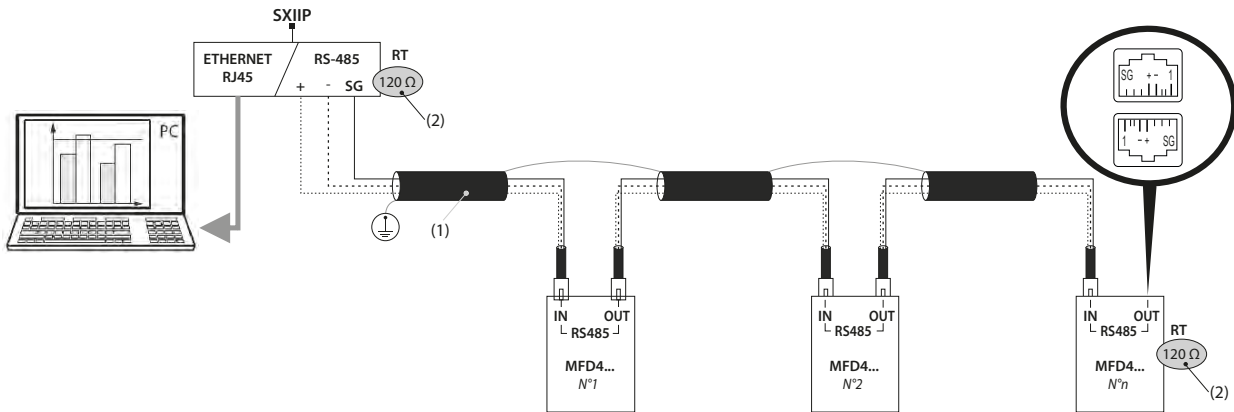

**Anschlussplan RS485 Modbus mit Mini Web Server:**

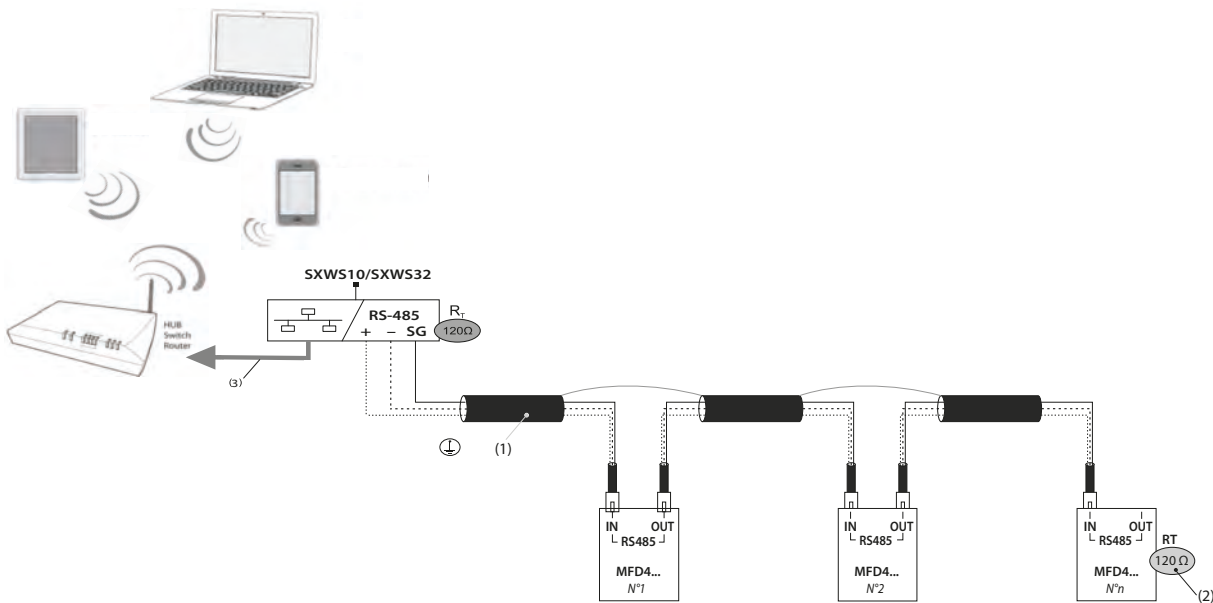

- (1) RS485: Vorgeschriebene Verwendung von Kabeln vom Typ Belden 9842, Belden 3106A (oder gleichwertig) für eine maximale Buslänge von 1000 m oder Kabel der Kategorie 6 (FTP oder UTP) für eine maximale Länge von 50 m.
- (2) 120Ω Abschlusswiderstand intern im Gerät (einstellbar über das SETUP-Menü)
- (3) Ethernet: Kat. 6 (FTP/UTP)
- (4) Die Klemme „SG“ darf auf keinen Fall geerdet werden

**Anschlussbilder Mbus:**

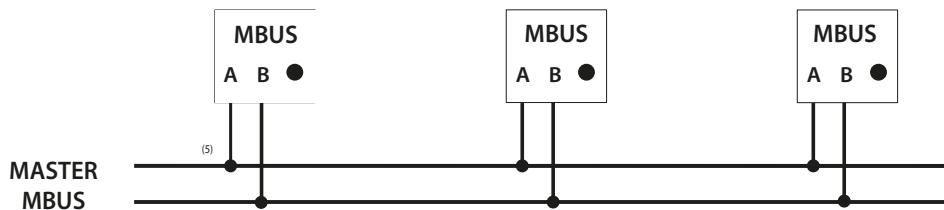

Nicht polarisierte Verbindungen  
(5) Ein zweiadriges Standardtelefonkabel (JYStY N°2\*0.8 mm)

**Kommunikationstabelle**

- Die Kommunikationsprotokolle MODBUS und MBUS sind unter <http://www.imeitaly.com> verfügbar

## Instrumento multifunción trifásico con 1 o 2 entradas "Easy Connect"

Códigos: MFD41ORFCDT – MFD42ORFCDT  
 MFD41ORFCMT – MFD42ORFCMT  
 Modelo: NEMO D4-ec



ROG630M2	ROG1600M2	ROG3200M2	ROG6300M2
Ø 50mm	Ø 100mm	Ø 150mm	Ø 240mm



Índice	Páginas
1. Uso .....	1
2. Gama .....	1
3. Instalación .....	1
4. Dimensiones .....	1
5. Conexiones .....	2
6. Datos de funcionamiento .....	3
7. Características generales .....	3
8. Conformidad y certificaciones .....	5
9. Comunicación .....	6

### 1. USO

El instrumento multifunción de 4 módulos DIN cuenta con un conector rápido para la conexión del trío de sensores de corriente de tipo Rogowski (versiones de 630A/ 1600A/ 3200A/ 6300A). El instrumento mide en 4 cuadrantes, apto para redes 3N-3E y 3-3E.

### 2. GAMA

Código del Artículo	Entradas I	Salida	Entradas Digitales	Rango de la Tensión
MFD41ORFCDT	1	Modbus	4 Tarifas	V-NV-V: 3x230/ 3x400±15% V-V: 3x230 ±15%
MFD42ORFCDT	2			
MFD41ORFCMT	1	Mbus		
MFD42ORFCMT	2			

Código	Bobinas Rogowski que pueden abrirse				
	Entrada (A)	Corriente min. (A)	Corriente max. (A)	Longitud del cable (m)	Diámetro (mm)
ROG630M2	630	12,5	750	2	50
ROG1600M2	1600	32,5	1950	2	100
ROG3200M2	3200	65,0	3900	2	150
ROG6300M2	6300	125,0	7500	2	240
Código del cable				Longitud del cable (m)	Cantidad
ROGEXM1	-	-	-	1	x 3 max.
ROGEXM3	-	-	-	3	x 1 max.

### 3. INSTALACIÓN

#### Fijación:

En carril simétrico EN/IEC 60715 o guía DIN 35.

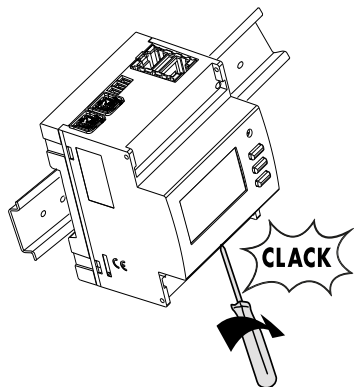

#### Posición de funcionamiento:

Vertical, horizontal, arriba y abajo, lateral



### 4. DIMENSIONES

Funda: 4 módulos DIN43880

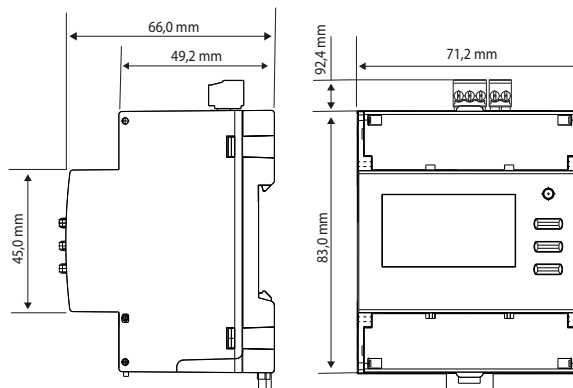

# Instrumento multifunción trifásico con 1 o 2 entradas "Easy Connect"

Códigos: MFD41ORFCDT – MFD42ORFCDT  
MFD41ORFCMT – MFD42ORFCMT

Modelo: NEMO D4-ec

## 5. CONEXIONES

### Esquemas de inserción:

- Red trifásica de 4 hilos o de 3 hilos (3N3E; 3-3E)

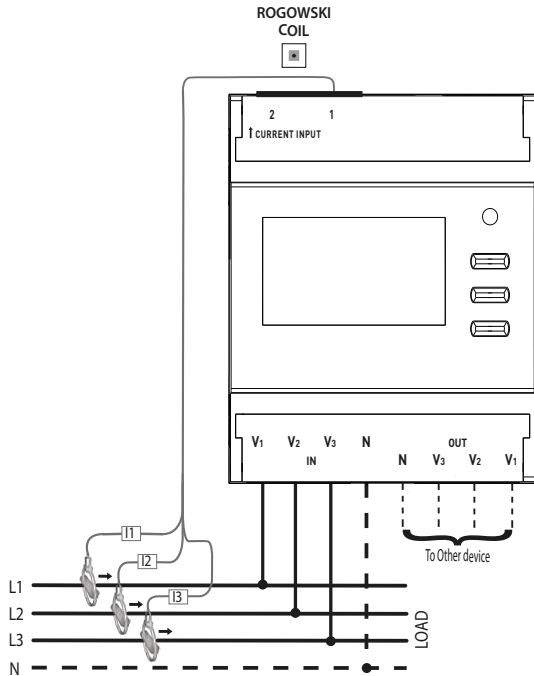

- Esquema con 2 sondas

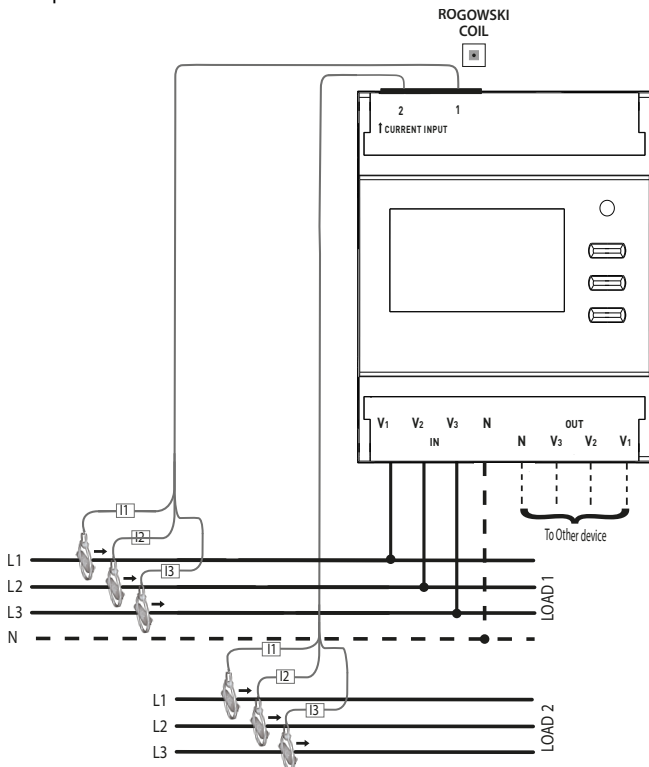

## 5. CONEXIONES

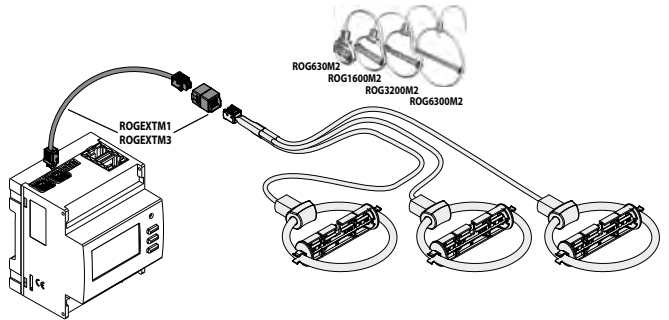

- Sensor Rogowski – Longitud del cable

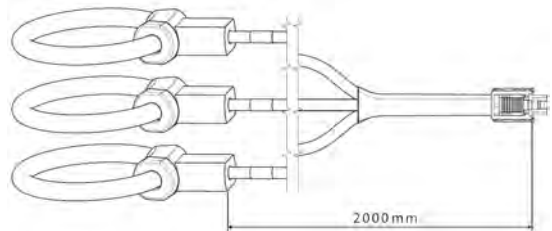

Esta longitud puede extenderse mediante el cable de extensión + conector de hasta 5 metros (2 m de cable Rogowski y hasta 3 m de extensión)

- **ROGEXTM1, ROGEXTM3:**

Cable de extensión para bobinas Rogowski

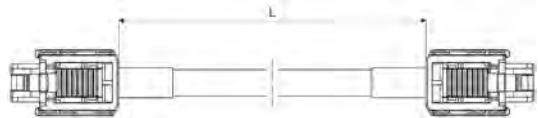

Código del Artículo	Longitud (mm)
ROGEXTM1	1000
ROGEXTM3	3000

Soporte centrador de plástico para bobinas Rogowski

Código del Artículo	Longitud (mm)
ROG630M2	79
ROG1600M2	123
ROG3200M2	173
ROG6300M2	263

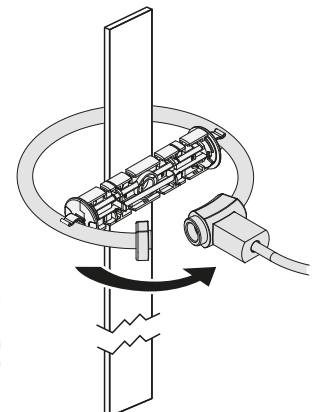
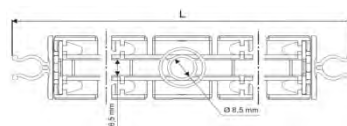

# Instrumento multifunción trifásico con 1 o 2 entradas "Easy Connect"

Códigos: MFD41ORFCDT – MFD42ORFCDT  
MFD41ORFCMT – MFD42ORFCMT

Modelo: NEMO D4-ec

## 6. DATOS DE FUNCIONAMIENTO

### 6.1 ELÉCTRICOS

Para todos los códigos MFD41ORFCDT – MFD42ORFCDT – MFD41ORFCMT - MFD42ORFCMT, el caudal de referencia (Iref) se programa en función de las Rogowski elegidas:

Caudal corrientes	I <sub>min</sub>	I <sub>ref</sub>	I <sub>max</sub>
630	12,5A	250A	750A
1600	32,5A	650A	1950A
3200	65A	1300A	3900A
6300	125A	2500A	7500A

### Tensiones V1,V2,V3,N:

- Tensión trifásica: V-N/ V-V : 3x230 /3x400 ±15%  
V-V: 3x230 ±15%

### Sección máxima de cables conectables a los bornes V1,V2,V3,N:

Bornes	Sin casquillo	Con casquillo
Cable rígido	0,05 + 1,5 mm <sup>2</sup>	0,05 + 2,5 mm <sup>2</sup>
Cable flexible	0,05 + 1,5 mm <sup>2</sup>	0,05 + 2,5 mm <sup>2</sup>

### Autoalimentado (bornes V y N):

- Frecuencia nominal: 50/60Hz  
- Frecuencia de funcionamiento: 45...65Hz  
- Autoconsumo: ≤ 2,5VA @230 Vca

### Potencia térmica máxima disipada por el dimensionamiento térmico de los cuadros: ≤ 5W

## 6.2 MECÁNICOS

### Morsetti a vite:

- Máx. dimensiones externas: 18mm  
- Longitudes de la peladura del cable para entrada y bus de 5 mm; para tensiones in/out de 7,5 mm

### Cabeza del tornillo:

- Bornes de conexión de las tensiones (V1, V2, V3, N) tornillos COMBI (cabeza de ranura/Phillips PH1) mientras que para bornes (N, V3, V2, V1): tornillos con cabeza de ranura.  
- Regletas en la parte superior del multifunción (entrada y bus): tornillos con cabeza de ranura

### Par de apriete recomendado:

- Bornes de conexión de las tensiones (V1, V2, V3, N): 0,5Nm  
- Bornes de conexión de las tensiones (N, V3, V2, V1): 0,5Nm  
- Regletas tarifas y comunicación (Modbus o Mbus): 0,2 Nm

### Herramientas necesarias:

- Para bornes versión BUS, utilizar destornillador Phillips de 2,5mm; para bornes con tensiones, utilizar destornilladores Phillips de 3,5mm y/o destornillador Phillips PH1

## 7. CARACTERÍSTICAS GENERALES (sigue)

### Datos de marcado:

Marcado indeleble

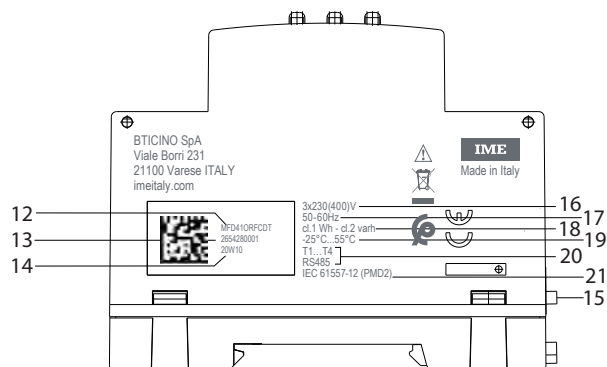
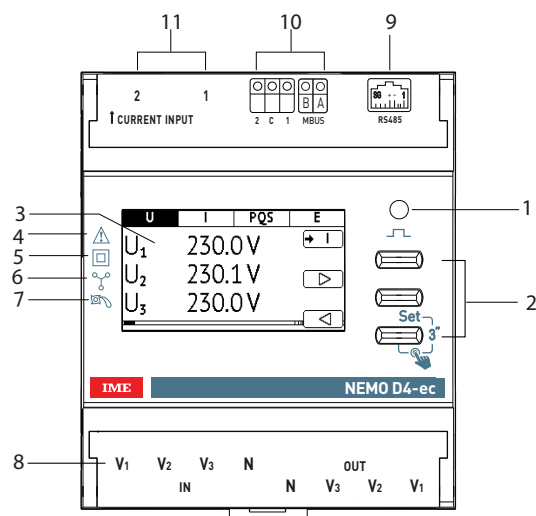

1. LED metrológico
2. Teclado de 3 botones multifunción
3. Display gráfico
4. Consultar el manual de uso antes de la instalación
5. Aislamiento doble
6. Inserción en línea trifásica de 4 hilos / 3 hilos
7. Dispositivo antirotación (antidecremento)
8. Tensiones
9. Conexión RJ45 para Modbus RTU
10. Comunicación Mbus y entrada tarifario
11. Entrada corrientes 1 / 2
12. Código del artículo
13. Datamatrix para trazabilidad del producto
14. Semana y año de fabricación
15. Tensiones
16. Tensiones nominales
17. Frecuencias nominales
18. Clases de precisión
19. Temperatura de uso
20. Entradas - Salidas
21. Normas de referencia

# Instrumento multifunción trifásico con 1 o 2 entradas "Easy Connect"

Códigos: MFD41ORFCDT – MFD42ORFCDT  
MFD41ORFCMT – MFD42ORFCMT

Modelo: NEMO D4-ec

## 7. CARACTERÍSTICAS GENERALES

### Tratamiento al láser:

#### Lado izquierdo

Información sobre el seguimiento

#### Lado derecho

Esquemas de conexión

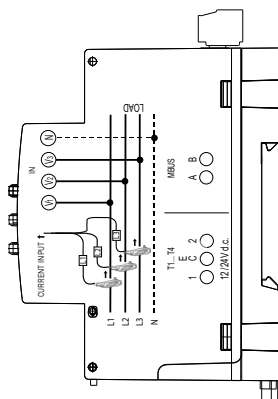
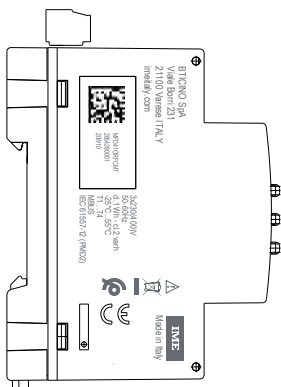
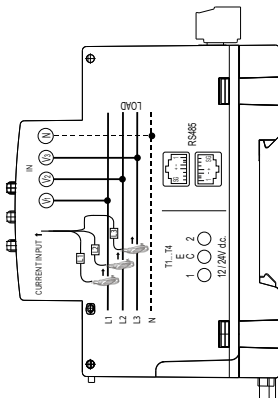
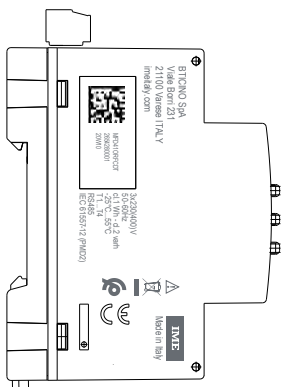

### Marcados salidas comunicación y entradas tarifarias:

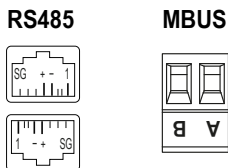
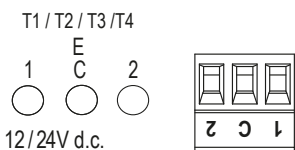

## 7. CARACTERÍSTICAS GENERALES (sigue)

### Pantalla y LED metrológico:

- Gráfico retroiluminado 1,8 pulgadas (256x128).

Entradas Rogowski	Resolución Energías	Wh/imp.
630A	1kWh/kvarh/kVAh	10
1600A	1kWh/kvarh/kVAh	25
3200A	1kWh/kvarh/kVAh	50
6300A	0,01MWh/Mvarh/MVAh	100

### Visualización del valor y programación:

- Mediante el teclado frontal, 3 botones (consultar el manual del usuario).
- Acceso protegido con un código de identificación (código predefinido 1000)

### Magnitudes medidas y precisión en conformidad a EN/IEC 61557-12

- Corriente: cl.1
- Tensión: cl.0,5
- Frecuencia: ± 0,1 Hz
- Potencia total activa instantánea, fase, valor medio y máx. valor medio: cl.1
- Potencia total reactiva instantánea, fase, valor medio y máx. valor medio: cl.2
- Potencia total aparente instantánea, fase, valor medio y máx. valor medio: cl.1
- Factor de potencia: cl.1
- Energía activa total y parcial, tarifarias, de fase, positiva y negativa cl.1
- Energía reactiva total y parcial, tarifas, de fase, positiva y negativa cl.2
- Energía aparente cl.1

**Las clases indicadas antes se garantizan manteniendo el centrado, entre sensor Rogowski y conductor primario, con los accesorios específicos suministrados y un contenido armónico entre los límites de la EN/IEC 61557-12**

### Análisis armónico (THD): valor y gráfico

- Hasta el 15° armónico

### Potencia media:

- Magnitud: potencia activa, reactiva, aparente
- Cálculo: media móvil, en el periodo seleccionado
- Tiempo media: 3/5/8/10/15/20/30/60min
- Load Profile (Curva de carga de potencia), diagrama de los 24 últimos valores de potencia media registrados:

### Tiempo de media ajustado | Intervalo de la curva

3 min	72 min
5 min	2 horas
60 min	24 horas

### Cuentahoras con puesta a cero:

- Recuento de horas y minutos de funcionamiento
- Resolución 8 cifras (6 para las horas + 2 para los minutos)
- Visualización máxima: 999999.99
- Valor programable: 0...50% Pn (Potencia activa positiva)



# Instrumento multifunción trifásico con 1 o 2 entradas "Easy Connect"

Códigos: MFD41ORFCDT – MFD42ORFCDT  
MFD41ORFCMT – MFD42ORFCMT

Modelo: NEMO D4-ec

## 7. CARACTERÍSTICAS GENERALES

### Entrada digital

- La entrada digital permite la conmutación del recuento de energía en 4 tarifas
- 3 bornes de entrada con punto en común (1 - C - 2)

Bornes	Sin casquillo	Con casquillo
Cable rígido	0,05 + 1,5 mm <sup>2</sup>	0,05 + 2,5 mm <sup>2</sup>
Cable flexible	0,05 + 1,5 mm <sup>2</sup>	0,05 + 2,5 mm <sup>2</sup>

- Tensión nominal: 12-24Vdc, 10mA Máx.

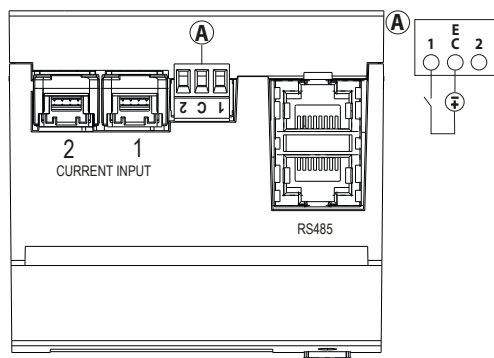

### Características del puerto de comunicación ModBus:

- Direcciones programables: 1 a 247 (5\*)
- Velocidad de comunicación: 4,8 – 9,6 – 19,2\* – 38,4 kbps
- Bits de paridad: ninguno, pares\*, impares
- Bits de stop: 1
- Aislamiento galvánico respecto de las entradas de medida
- Estándar RS485 3 hilos, Half-Duplex, en conector RJ45
- Protocolo Modbus® RTU
- Tiempo de respuesta: ≤ 200ms
- Resistencia de terminación de 120Ω interna en el instrumento (ajustable en el menú de SETUP, valor predefinido none\*)
- **MFD41ORFCDT:** Dirección programable de 1 a 247
- **MFD42ORFCDT:** Dirección programable de n = 1 a n = 246 para medidas primera entrada y dirección n+1 (asignada automáticamente) para medidas según entrada

### Características del puerto de comunicación MBus:

- Estándar: EN 13757
- Transmisión: asíncrona serial
- N°-bit: 8
- Bits de paridad: pares fija
- Velocidad de comunicación: 300-600-1.200-2.400\*-4.800-9.600bit/s
- N.º dirección primaria: 0\*...250
- **MFD41ORFCMT / MFD42ORFCMT:** Dirección primaria programable de 0 a 250
- **MFD41ORFCMT / MFD42ORFCMT:** Dirección secundaria programable de 0 a 99999999
- Load MBus: 1
- Aislamiento galvánico respecto de las entradas de medida
- Medidas transferidas: ver el protocolo de comunicación

### \* Datos de fábrica

## 7. CARACTERÍSTICAS GENERALES

### Recomendaciones:

**Para la protección del dispositivo contra sobrecargas y cortocircuitos, se aconseja utilizar un interruptor magnetotérmico**

### Clase de protección:

- Grado de protección de los bornes contra contactos directos: IP 20 (IEC/EN 60529);
- Índice de protección parte frontal contra contactos directos: IP 54 (IEC/EN 60529);
- Clase II: panel frontal con placa;
- Clase de protección contra impactos mecánicos IK03 (IEC/EN 62262)

### Resistencia a las vibraciones:

- Vibración: de 5 a 150Hz amplitud 0,15mm/1g
- Choque: 19g / 16msec

### Material de la funda:

BLEND >PC + ABS<;  
Identificación según ISO 11469: >PC<;  
GWFI IEC 60965-2-12 (§1.6mm): 850°C;  
Clasificación reacción a la llama UL 94 / IEC 60695\_11\_10 (1.6/3.2 mm): V2;

### Temperatura ambiente de funcionamiento:

- Tmin. = - 20 °C; Tmax. = + 60°C.

### Temperatura ambiente de almacenaje:

- Tmin. = - 25 °C; Tmax. = + 70 °C

**Peso:** 0,270Kg

**Volumen embalado:** 1,5 dm<sup>3</sup>.

**Ambiente:** mecánico M1 - eléctrico E2

## 8. CONFORMIDAD Y CERTIFICACIONES

### Aislamiento:

- Categorías de medida: III (según EN-61010)
- Grado de contaminación: 2
- Tensión de aislamiento, Ui: 300V, Fase-Neutro

### Rigidez dieléctrica:

- Alimentazioni / Uscite: 3kV / 50Hz / 1min
- Involucro / Terminali: 4kV / 50Hz / 1min

### Impulso:

- Alimentaciones: 6.3kV / 1,2 – 50µsec / 0,5J

### Conformidad a las normas:

- Clase de precisión: Energía activa clase 1 (IEC/EN62053-21)
- Clase de precisión: Energía reactiva clase 2 (IEC/EN62053-23)
- Compatibilidad electromagnética: Pruebas en conformidad a la EN/IEC 62052-11 / EN 61326-1
- Clase de precisión en conformidad a la IEC/EN61557-12
- 2014/35/UE 2014/30/UE

### Respeto del medio ambiente - Conformidad a las directivas CEE:

- Conformidad a la directiva 2011/65/UE, modificada por la directiva 2015/863 (RoHS 2), relativa a las limitaciones sobre la utilización de algunas sustancias peligrosas en los aparatos eléctricos y electrónicos.
- Conformidad al Reglamento REACH (1907/2006): en la fecha de publicación de este documento, ninguna sustancia insertada en el anexo XIV se encuentra presente en el interior de estos productos.
- Directiva RAEE (2012/19/EU): la comercialización de este producto contempla una aportación a los eco-organismos encargados, en cada país europeo, de la gestión del fin de vida de los productos pertenecientes al campo de aplicación de la directiva europea sobre los residuos de aparatos eléctricos y electrónicos.

### Materias plásticas:

- Materias plásticas sin halógenos.
- Marcado de las partes según las normas ISO 11469 e ISO 1043.

### Embalajes:

- Diseño y producción de los embalajes en cumplimiento del Decreto 98-638 del 20/07/1998 y de la directiva 94/62/CE

# Instrumento multifunción trifásico con 1 o 2 entradas "Easy Connect"

Códigos: MFD41ORFCDT – MFD42ORFCDT  
MFD41ORFCMT – MFD42ORFCMT  
Modelo: NEMO D4-ec

## 9. COMUNICACIÓN

### Esquema de conexión RS485 Modbus:

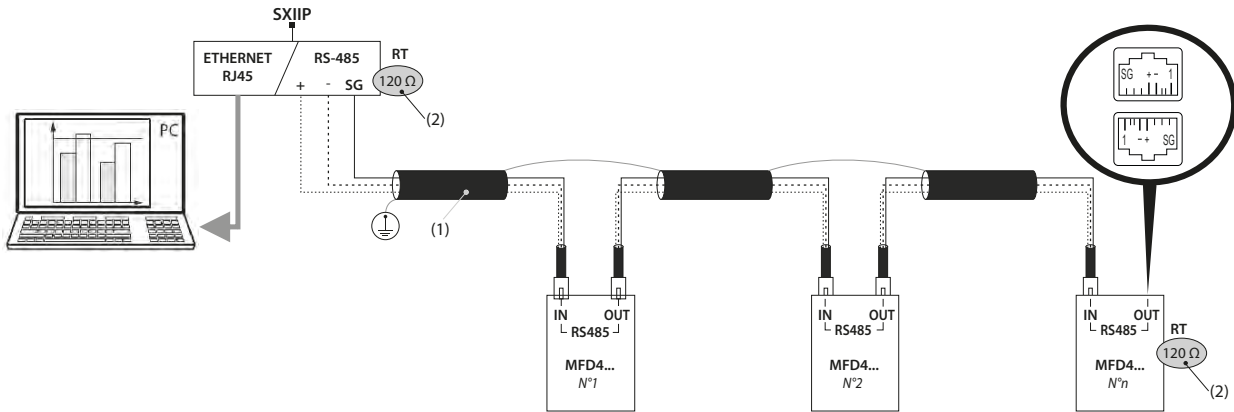

### Esquema de conexión RS485 Modbus con Mini Web Server:

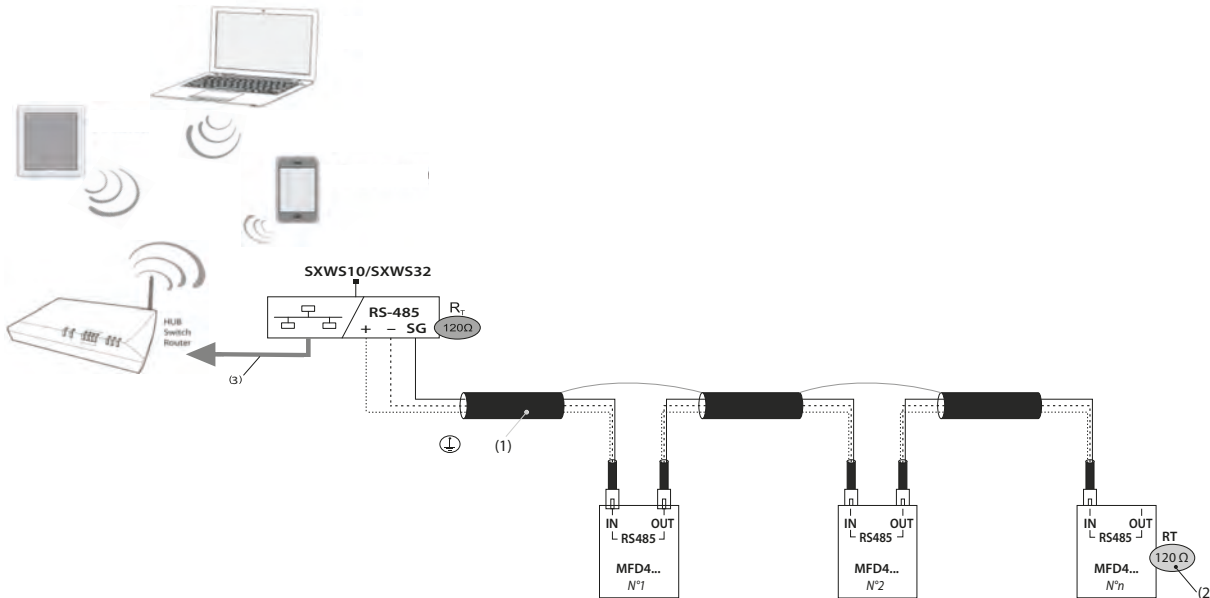

- (1) RS485: Uso prescrito de un cable de tipo Belden 9842, Belden 3106A (u otro equivalente) para una longitud máxima del bus de 1000 m, o de un cable de Categoría 6 (FTP o UTP) para una longitud máxima de 50 m
- (2) Resistencia de terminación de 120Ω interna en el instrumento
- (3) Ethernet: Cat. 6 (FTP/UTP)
- (4) El borne "SG" no se ha de conectar a tierra

### Esquema de conexión Mbus:

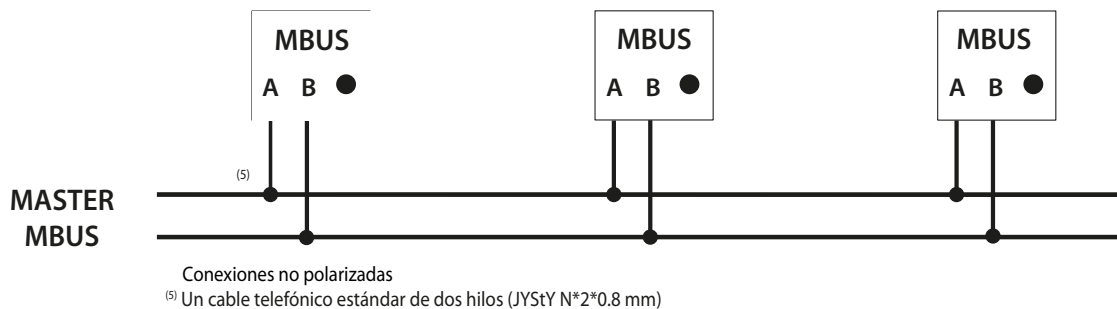

### Tablas de comunicación

- Los protocolos de comunicación MODBUS y MBUS están disponibles en el sitio <http://www.imeitaly.com>