

Energy meter on CT/5A, MID indirect connection

Codes: **F41TMAN**



Contents	Pages
1. Use.....	1
2. Range	1
3. Installation.....	1
4. Dimensions.....	1
5. Connections	2
6. Operating data.....	3
7. General features.....	4
8. Conformity and certifications.....	7
9. Communication.....	8

1. USE

Bidirectional active and reactive energy meter (4 quadrants). Indirect connection through /5A ratio current transformers. The device, 4 DIN modules, is self-powered and has ModBus communication and double tariff input. On the menu it is possible to select the device configuration for operation with the different types of connections (3N3E;3-3E;3-2E).

MID Certification

2. RANGE

Code Art.	Model	Connection	Weight
F41TMAN	Double tariff ModBus	Screw terminals	0,210Kg

3. INSTALLATION

Fixing:

On EN/IEC 60715 symmetric rail or DIN 35 rail.

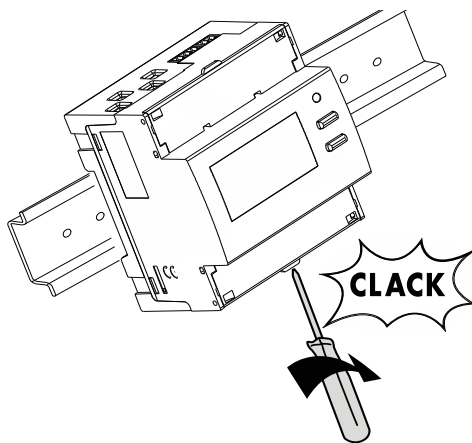

Necessary tools:

For fastening the device on the DIN rail: 5.5 mm flat screwdriver (from 4 to 6 mm).

Operating position:

Vertical, Horizontal, Upside down, On the side

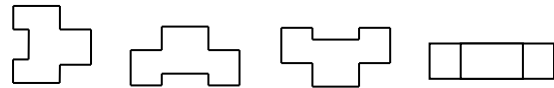

4. DIMENSIONS

Housing: 4 DIN43880 modules

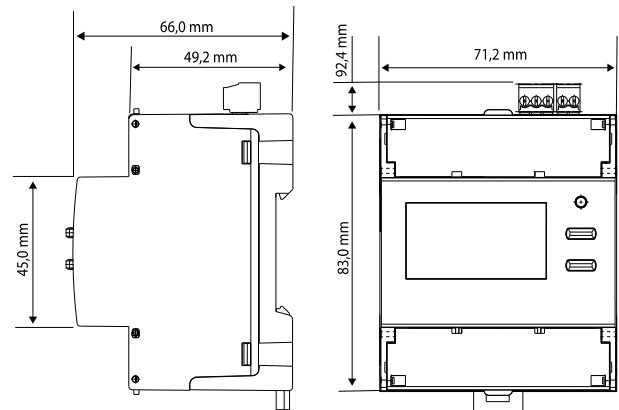

Energy meter on CT/5A, MID indirect connection

Codes: F41TMAN

5. CONNECTIONS

Terminal board marking and diagram combination:

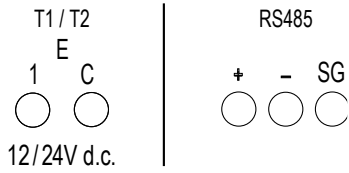

Connection on VT:

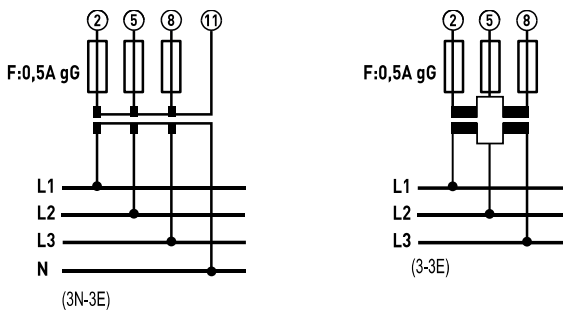

5. CONNECTIONS (continues)

Wiring diagrams:

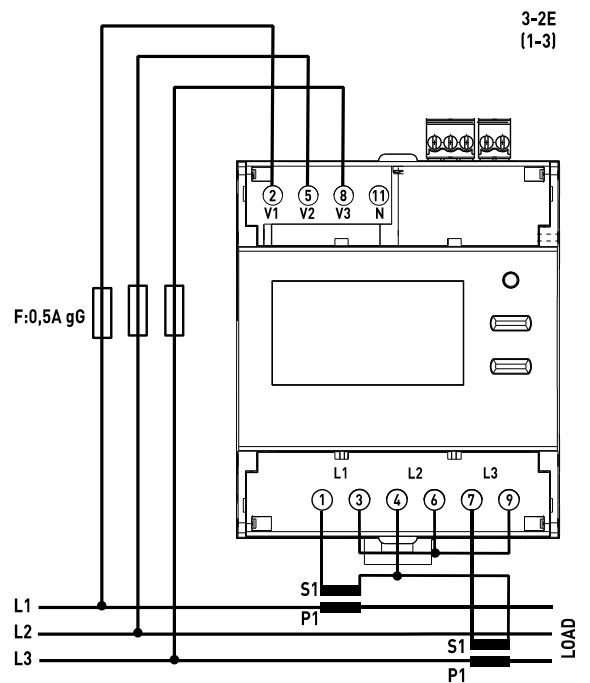
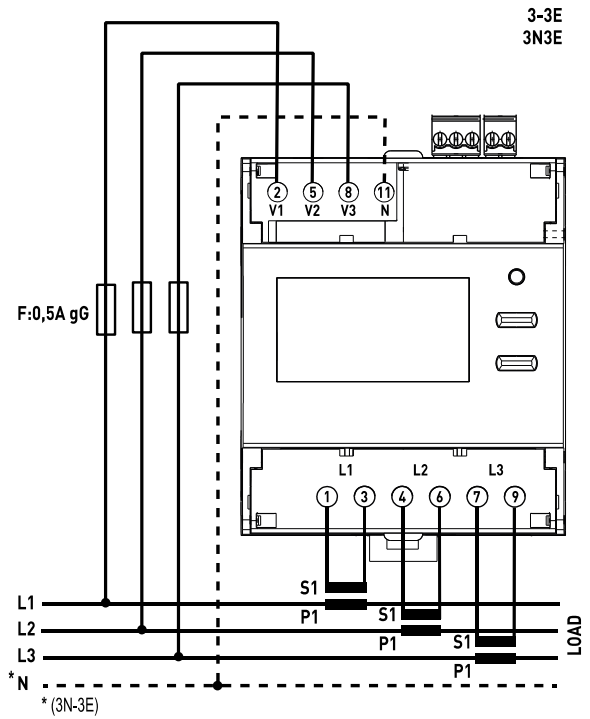

Energy meter on CT/5A, MID indirect connection

Codes: **F41TMAN**

5. CONNECTIONS

Wiring diagrams:

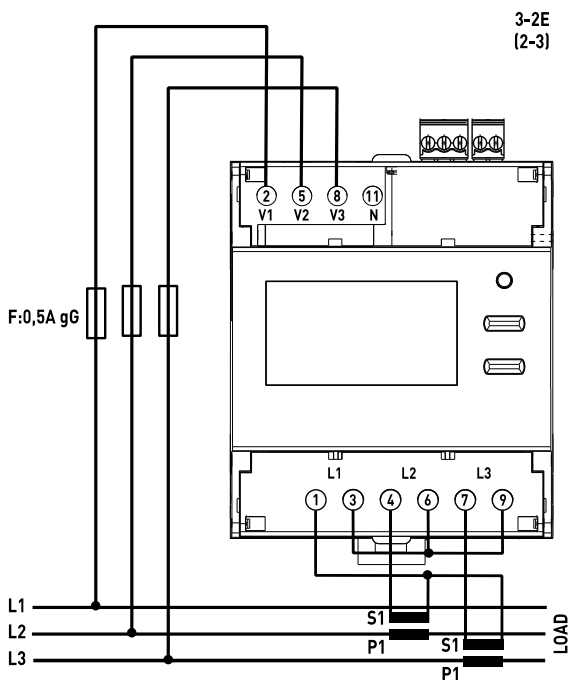
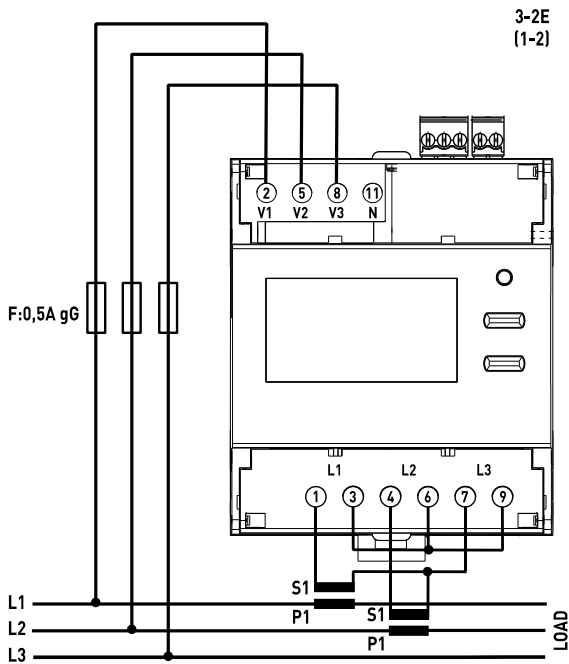

6. OPERATING DATA *(continues)*

6.1 ELECTRIC DATA

Currents:

- Minimum measurement current: 0,05-5(6)A
- Starting current, I_{st} : 10mA

Rated voltages:

- Three-phase rated voltage U_n :
3x100...3x400V, 3x100/173...3x230/400V ~ ± 15%

Frequenza nominale:

- F_n : 50Hz; 60Hz
- Variazione ammessa: 49...51Hz; 59...61Hz

Rated frequency:

- F_n : 50Hz; 60Hz
- Permitted variation: 49...51Hz; 59...61Hz

Connectable section:

- Copper wires
- Voltage connection terminals (V1, V2, V3, N)
- Current connection terminals (L1, L2, L3)

	Without bush	With bush
Rigid wire	1 x 0,75 ÷ 16 mm²	-
Flexible wire	1 x 0,75 ÷ 16 mm² (∅ 5mm)	1 x 4 ÷ 10 mm²

- Terminal boards in the upper part of the meter (RS485):

	Without bush	With bush
Rigid wire	1 x 0,2 ÷ 1,5 mm²	-
Flexible wire	1 x 0,2 ÷ 1 mm²	1 x 0,2 ÷ 1 mm²

Utensili necessari:

- For all measuring terminals: screwdriver with 6mm blade or Pozidriv No. 2
- For the terminal boards in the upper part of the meter (input): screws with 2.5mm blade

Energy meter on CT/5A, MID indirect connection

Codes: **F41TMAN**

6.2 MECHANICAL DATA

Screw terminals:

- Depth of the terminals: 12mm
- Lengths of the wire stripping: 11mm

Screw head:

- Voltage (V1, V2, V3, N) and current (L1, L2, L3) connection terminals: screws with countersunk head with hexagon socket and Pozidriv No. 2
- Terminal boards in the upper part of the meter (input): screws with countersunk head with hexagon socket

Recommended torque:

- Voltage connection terminals (V1,V2,V3,N): from 1,6 to 2Nm
- Current connection terminals (L1,L2,L3): from 1,6 to 2Nm
- Terminal boards in the upper part of the meter (input): 0.2 N/m

Terminal protection:

- The power terminals are protected with sliding and sealable terminal front covers which are integrated in the device

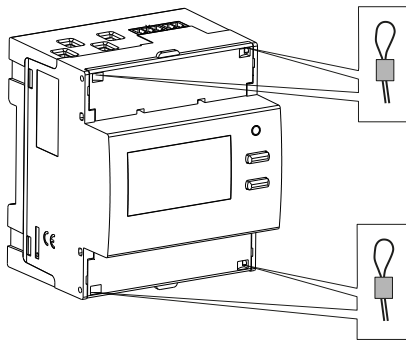

7. GENERAL FEATURES (continues)

Marking data:

Indelible marking

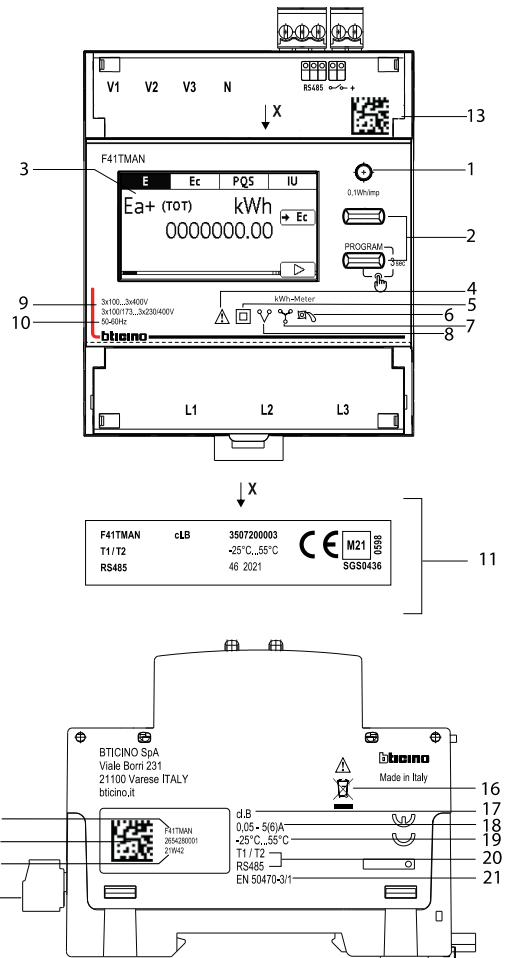

1. Metrological LED
2. Keypad made up of 2 double-function pushbuttons (display/configurations)
3. Graphic display
4. Consult the user manual before installation
5. Double insulation
6. Connection on 3-wire three-phase line
7. Connection on 4-wire three-phase line
8. Anti-rotation device (anti-decreasing)
9. Voltage
10. Frequency
11. MID label
12. Product code
13. Datamatrix for product traceability
14. Week and year of manufacture
15. Output connection terminals
16. RAEE Symbol
17. Precision class
18. Correnti Current
19. Temperature of use
20. Outputs
21. MID standard

7. GENERAL FEATURES

Laser marking

Left side
Traceability information

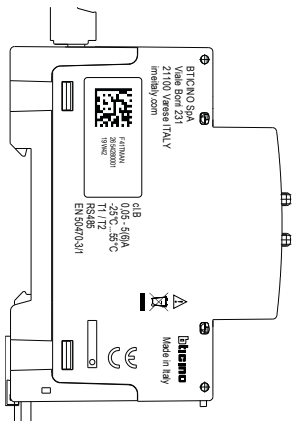

Right side
Wiring diagram

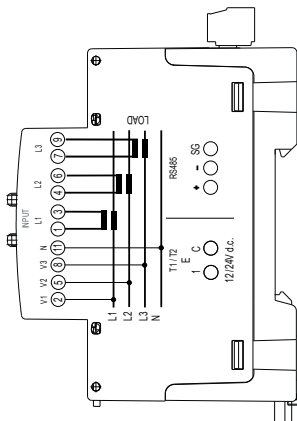

7. GENERAL FEATURES (continues)

Display:

- Graphic, backlit, 1.8 inches (256x128).

Resolution:

- Total meters: 0,01kWh/kvarh
- Partial meters: 0,01kWh/kvarh
- Tariff meters: 0,01kWh/kvarh
- CT Ratio: 1...9999
- VT Ratio: 1,0...300,00

Maximum indication

- Total meters: 9 999 999,99
- Partial meters: 9 999 999,99
- Tariff meters: 9 999 999,99

Metrological LED: 0,1Wh/imp.

Display of the value and programming:

- By means of the front keypad, 2 pushbuttons.
- Change protected by identification code (**predefined code 1000**);
the code can be changed during the programming procedure.

Measurements and precision:

Conformity with EN/IEC 50470-1 -3

- Active Energy cl.B

Conformity with EN/IEC 62053-23

- Reactive Energy cl.2

Conformity with EN/IEC 61557-12

- Current: cl.0,5
- Voltage: cl.0,5
- Frequency: ± 0,1 Hz
- Instantaneous total active power, phase, average value and max.
average value cl.1
- Instantaneous total active power, phase, average value and max.
average value: cl.1
- Instantaneous total reactive power, phase: cl.2
- Instantaneous total apparent power, phase: cl.1
- Power Factor: cl.1

Average power:

- Measurement: active power
- Calculation: moving average, on the selected period
- Average time: 5/8/10/15/20/30/60 min.

Hour meter:

- Counting of operating hours and minutes (**resettable meter**)
- Resolution: 7 figures (5 for the hours + 2 for the minutes)
- Maximum display: 99 999.59 (tariff total)
- Programmable value: 0...50% Pn (positive)

Energy meter on CT/5A, MID indirect connection

Codes: F41TMAN

7. GENERAL FEATURES

Digital input

- The digital input allows switching the energy counting on 2 tariffs
- 2 input terminals with common point (1 - C)
- Rated voltage: 12 – 24V d.c. max. 10mA

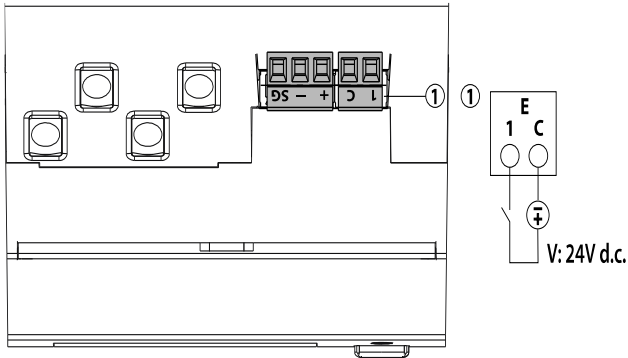

Features of the ModBus communication port:

- Programmable addresses: from 1 to 255 (5*)
- Communication speed: 4.8 – 9.6 – 19.2* – 38.4 kbps
- No. of bit: 8
- Parity bit: none, even*, odd
- Stop bit: 1
- Galvanically isolated with respect to the measurement inputs
- Standard RS485 3 wires, half-duplex
- Modbus® RTU protocol
- Response time (question/response time-out): $\leq 200\text{ms}$
- 120 Ω terminating resistor inside the instrument (it can be set in the SETUP menu, default value: none*)

* Factory setting

7. GENERAL FEATURES

Auxiliary power supply:

- Shunted from the power socket (Self-supplied)

Operating room temperatures:

- Min. = - 25 ° C Max. = + 55 ° C

Room storage temperatures:

- Min. = - 25 ° C Max. = + 70 ° C
- Max. humidity. 85% non-condensing

Short-duration overcurrent:

- 20 I_{max} per 0,5sec

Short circuit current:

- Test not applicable to indirect meters.

Voltage circuit self-consumption:

- Max.1,5VA three-phase

Current circuit self-consumption:

- Max.1,8W for each phase

Maximum dissipated thermal power for the thermal dimensioning of the panels: $\leq 6\text{W}$

Protection class:

- Terminal protection index against solid bodies and liquids: IP 20 (IEC/EN 60529).
- Housing protection index against solid bodies and liquids: IP 54 (IEC/EN 60529).

Protection of the device:

- By means of thermal-magnetic circuit breaker and 0.5A gG fuse

Room: mechanical M1 – electric E2 (according to the directive MID 2014/32/UE)

Housing material: Polycarbonate

Packaged volume: 0,60 dm³.

Wheight: 0,210Kg

8. CONFORMITY AND CERTIFICATIONS

Insulation

- Measurement categories: III
- Level of pollution: 2
- Insulation voltage, U_i : 300V, Phase-Neutral

Dielectric rigidity:

- Power supplies/ Outputs: 4kV / 50Hz / 1min
- Housing / Terminals: 4kV / 50Hz / 1min

Pulse:

- Power supplies: 6.3kV / 1.2 – 50 μ sec / 0.5J
- Power supplies/ Outputs: 6.3kV / 1.2- 50 μ s / 0.5J

In compliance with the standards:

- Precision class: Class B active energy (EN 50470-1, -3)
- Precision class: Class 2 reactive energy (EN/IEC 62053-23)
- Electromagnetic compatibility: Tests in accordance with EN 50470-1, -3
- Precision class according to IEC/EN61557-12

Respecting the environment – Conformity with the CEE directives:

- Conformity with directive 2011/65/EU modified by directive 2015/863 (RoHS 2) which restricts hazardous substances such as lead, mercury, cadmium, hexavalent chromium, brominated flame retardants, polybrominated biphenyls (PBB) and polybrominated diphenyl ethers (PBDE)
- Conformity with directive 91/338/CEE of 18/06/91 and decree 94-647 of 27/07/04
- Conformity with the REACH regulation

Plastic materials:

- Plastic materials without Halogens.
- Part marking according to standards ISO 11469 and ISO 1043.

Packaging:

- Packaging designed and produced in accordance with Decree 98-638 of 07.20.98 and directive 94/62/CE

9. COMMUNICATION

RS485 Modbus wiring diagram:

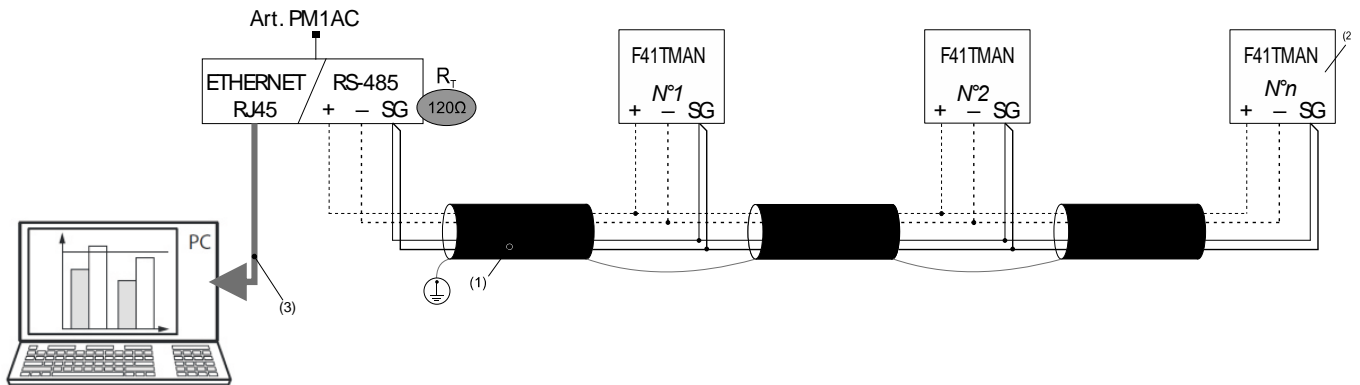

RS485 Modbus wiring diagram with Mini Web Server:

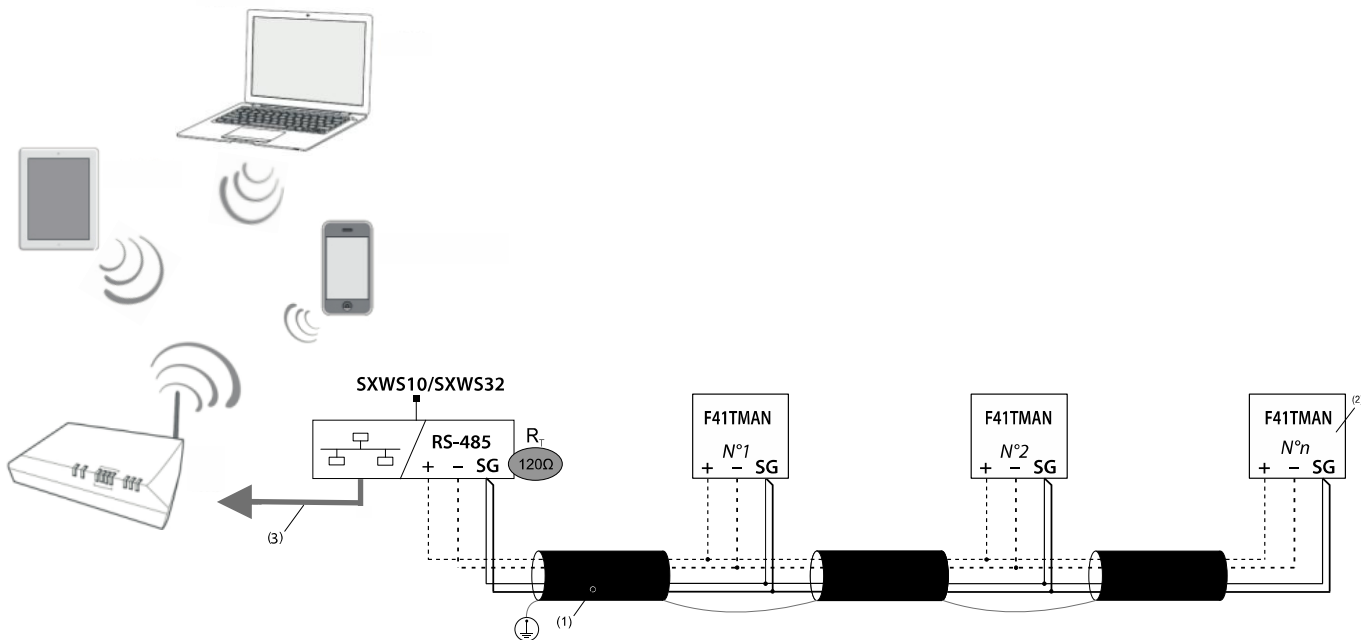

- (1) RS485: Required use of Belden 9842 or Belden 3106A wire (or equivalent) for a maximum bus length of 1000 m, or Category 6 wire (FTP or UTP) for a maximum length of 50 m
- (2) 120Ω terminating resistor inside the instrument (it can be set in the SETUP menu)
- (3) Ethernet: Cat. 6 (FTP/UTP)

Communication tables

- The MODBUS communication protocols are available on the <http://www.catalogo.bticino.it>