

Contatore di energia su TA /1A - /5A, a inserzione indiretta

Codici: **CE4TBDTCL1 – CE4TB0PCL1 – CE4TBMTC1**
 Modello: **CONTO D4-Pt**



Sommario	Pagine
1. Uso	1
2. Gamma	1
3. Installazione	1
4. Dimensioni	1
5. Connessioni	2
6. Dati operativi	3
7. Caratteristiche generali	4
8. Conformità e certificazioni	7
9. Comunicazione	8

1. USO

Contatore di energia attiva e reattiva bidirezionale (4 quadranti). Connessione indiretta tramite Trasformatori di corrente con rapporto /1A - /5A, Il dispositivo, in 4 moduli DIN, è autoalimentato ed è dotato di comunicazione ModBus o Mbus o di uscita impulsi e di ingresso doppia tariffa. Da menu si può scegliere di configurare il dispositivo per il funzionamento nei diversi tipi di connessione (3N3E;3-3E;3-2E; 1N1E).

2. GAMMA

Codice Articolo	In	Uscite	Ingressi	Range tensione
CE4TB0PCL1	1/5A	Impulsi	Impulsi	3x100V 3x230V 3x400V ± 15%
CE4TBDTCL1	1/5A	ModBus	2 Tariffe / Impulsi	3x100V 3x230V 3x400V ± 15%
CE4TBMTC1	1/5A	Mbus	2 Tariffe / Impulsi	3x100V 3x230V 3x400V ± 15%

3. INSTALLAZIONE

Fissaggio:

Su rotaia simmetrica EN/IEC 60715 o guida DIN 35.

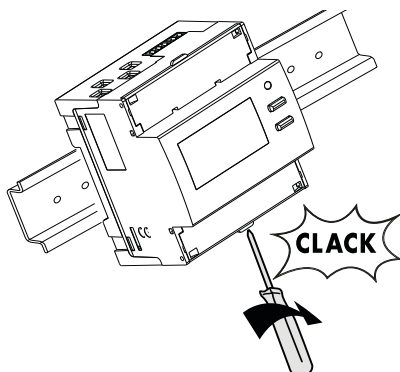

Utensili necessari:

Per il fissaggio del dispositivo sulla guida DIN: cacciavite piatto da 5,5 mm (da 4 a 6 mm).

Posizione di funzionamento:

Verticale, Orizzontale, Sottosopra, Sul lato



4. DIMENSIONI

Custodia: 4 moduli DIN43880

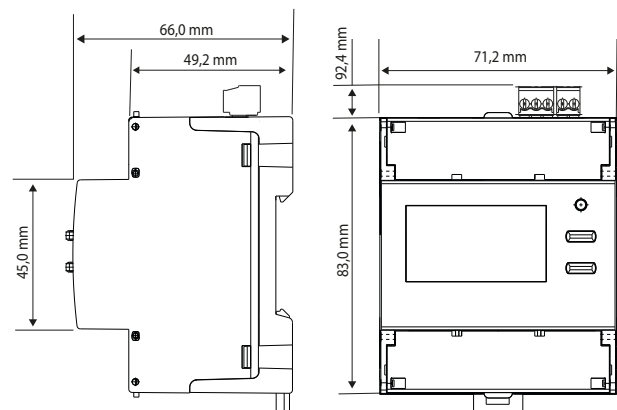

**Contatore di energia su TA /1A - /5A,
a inserzione indiretta**

Codici: CE4TBDTCL1 – CE4TB0PCL1 – CE4TBMTC11
Modello: CONTO D4-Pt

5. CONNESSIONI - COLLEGAMENTO

Marcatore morsettiere e combinazione schemi:

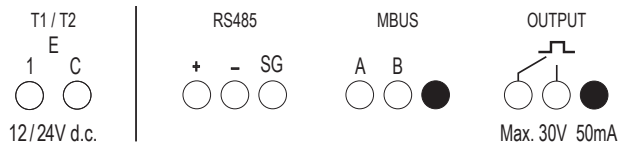

Schemi di inserzione:

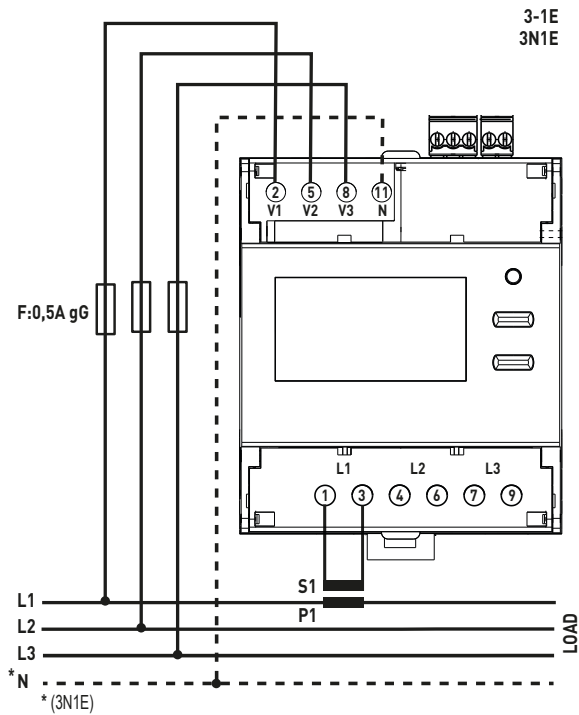
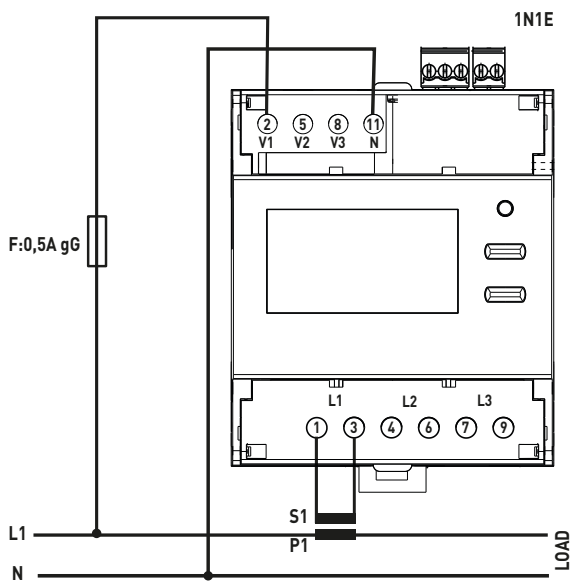

5. CONNESSIONI - COLLEGAMENTO (continua)

Schemi di inserzione:

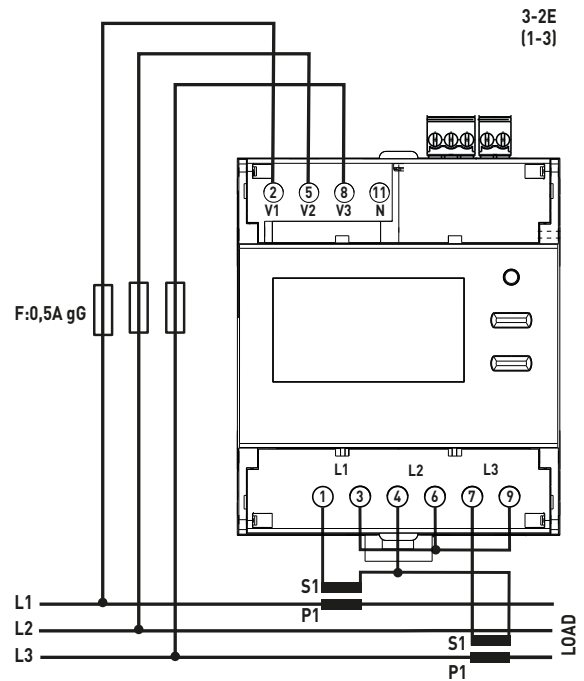
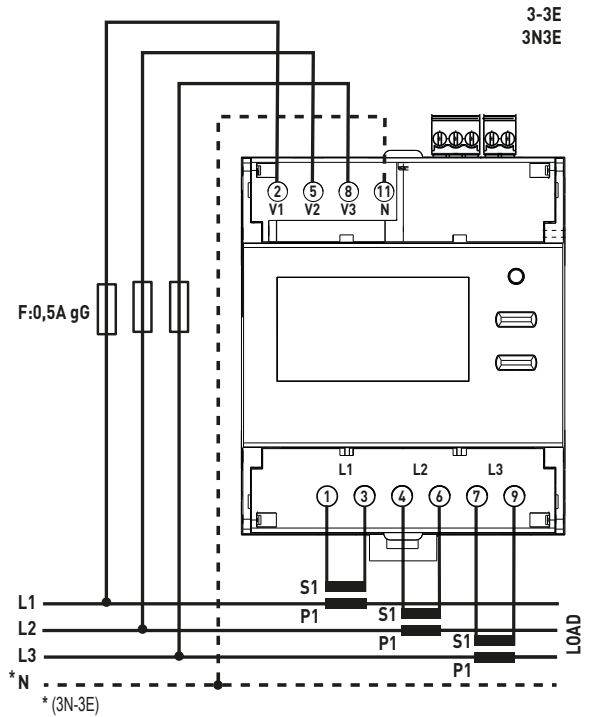

Contatore di energia su TA /1A - /5A, a inserzione indiretta

Codici: CE4TBDTCL1 – CE4TB0PCL1 – CE4TBMTCCL1
Modello: CONTO D4-Pt

5. CONNESSIONI - COLLEGAMENTO

Schemi di inserzione:

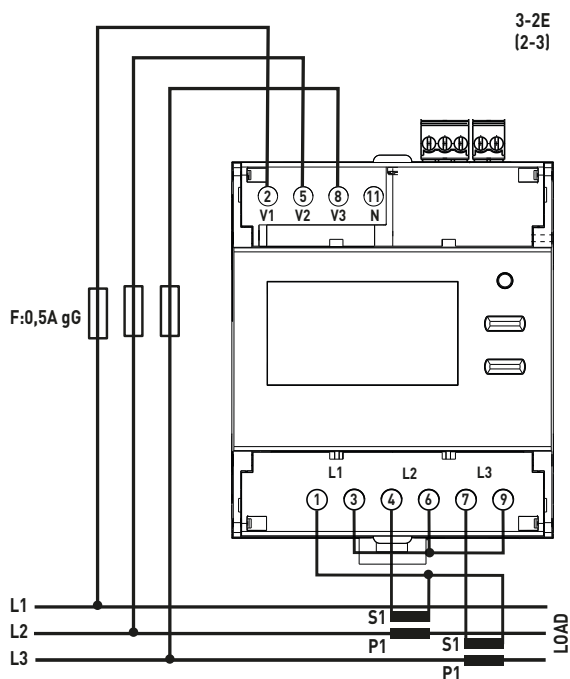
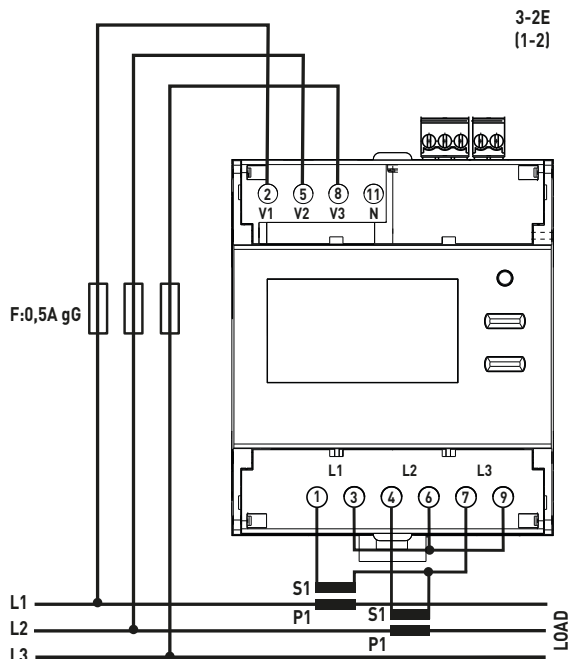

5. CONNESSIONI - COLLEGAMENTO

Inserzione su TV:

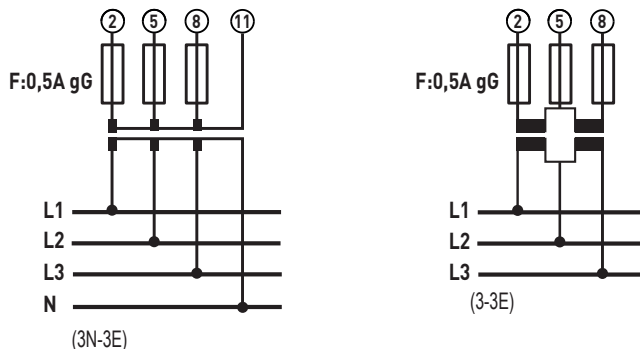

6. DATI OPERATIVI (continua)

6.1 ELETTRICI

Correnti:

- Corrente minima di misura: 0,05-5(6)A / 0,01-1(1,2)A
- Corrente d'avviamento, I_{st} : 10mA

Tensioni nominali:

- Tensioni trifase U_n : 3x100...3x400V, 3x100/173...3x230/400V $\pm 15\%$

Frequenza nominale:

- F_n : 50Hz; 60Hz
- Variazione ammessa: 49...51Hz; 59...61Hz

Sezione collegabile:

- Cavi in rame.
- Morsetti collegamento delle tensioni (V1, V2, V3, N)
- Morsetti collegamento delle correnti (L1, L2, L3)

	Senza bussola	Con bussola
Cavo rigido	1 x 0,75 + 16 mm²	-
Cavo flessibile	1 x 0,75 + 16 mm² (\varnothing 5mm)	1 x 4 + 10 mm²

- Morsettiere nella parte superiore del contatore (ingresso, uscita impulsi e bus):

	Senza bussola	Con bussola
Cavo rigido	1 x 0,2 + 1,5 mm²	-
Cavo flessibile	1 x 0,2 + 1 mm²	1 x 0,2 + 1 mm²

Utensili necessari:

- Per tutti i morsetti di misura: cacciavite a lama 6mm o Pozidriv n°2
- Per le morsettiere nella parte superiore del contatore (ingresso, uscita impulsi e bus): cacciavite a lama 2,5mm

Contatore di energia su TA /1A - /5A, a inserzione indiretta

Codici: CE4TBDTCL1 – CE4TB0PCL1 – CE4TBMTCCL1
Modello: CONTO D4-Pt

6.2 MECCANICI

Morsetti a vite:

- Profondità dei morsetti: 12mm
- Lunghezze della spelatura del cavo: 11mm

Testa della vite:

- Morsetti di collegamento di tensioni (V1, V2, V3, N) e correnti (L1, L2, L3): viti con testa mista ad intaglio e Pozidriv n°2
- Morsettiere nella parte superiore del contatore (ingresso, uscita impulsi e bus): viti con testa ad intaglio

Coppia di serraggio raccomandata:

- Morsetti di collegamento delle tensioni (V1, V2, V3, N): da 1,6Nm a 2Nm
- Morsetti di collegamento delle correnti (L1, L2, L3): da 1,6Nm a 2Nm
- Morsettiere nella parte superiore del contatore (ingresso, uscita impulsi e bus): 0,2 N/m

Protezione dei morsetti:

- I terminali di potenza sono protetti con mostrine copri morsetti scorrevoli e sigillabili che sono integrate nel dispositivo.

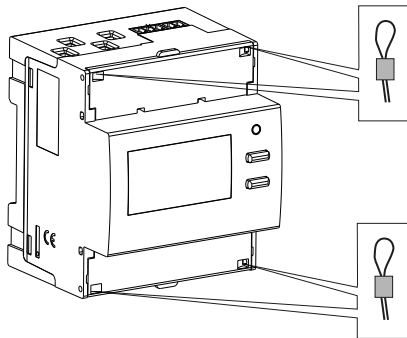

7. CARATTERISTICHE GENERALI (continua)

Dati di marcatura:

Marcatura indelebile

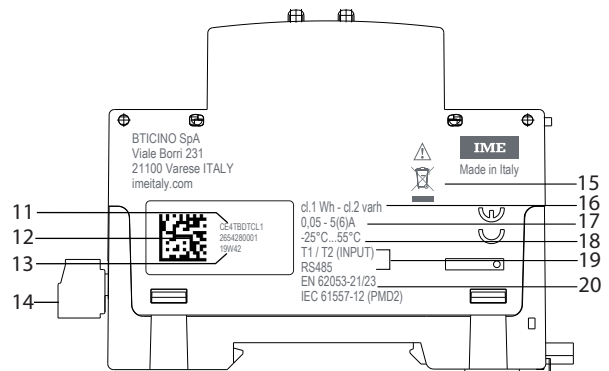
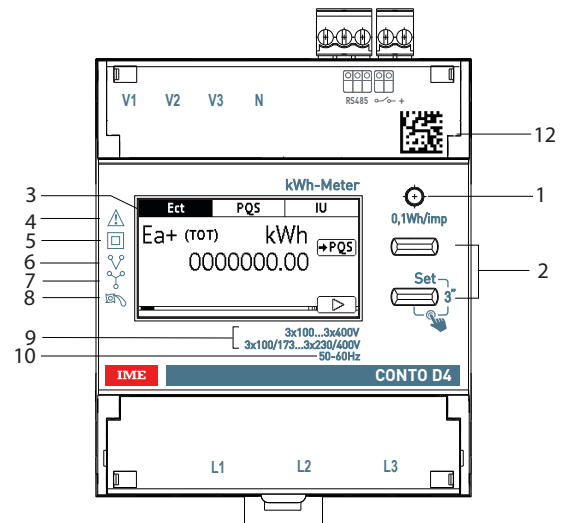

1. LED metrologico
2. Tastiera composta da 2 pulsanti a doppia funzionalità (visualizzazione/configurazione)
3. Display grafico
4. Consultare manuale d'uso prima dell'installazione
5. Doppio isolamento
6. Inserzione su linea trifase 3 fili
7. Inserzione su linea trifase 4 fili
8. Dispositivo antirotazione (antidecremento)
9. Tensioni
10. Frequenza
11. Codice articolo
12. Datamatrix per tracciabilità prodotto
13. Settimana e anno di fabbricazione
14. Morsetti di connessione uscite
15. Simbolo RAEE
16. Classe di precisione
17. Correnti
18. Temperatura d'impiego
19. Uscite
20. Normativa

Contatore di energia su TA /1A - /5A, a inserzione indiretta

Codici: CE4TBDTCL1 – CE4TB0PCL1 – CE4TBMTCL1
Modello: CONTO D4-Pt

7. CARATTERISTICHE GENERALI

Laseratura:

Lato Sinistro

Informazioni di tracciabilità

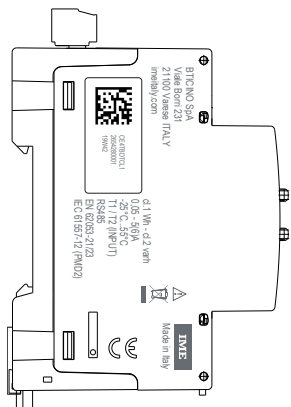

Lato Destro

Schemi di collegamento

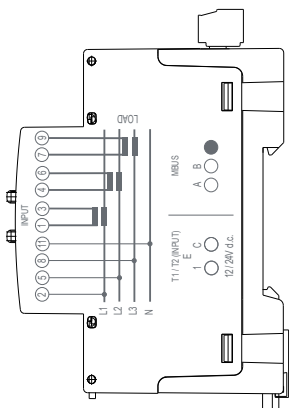
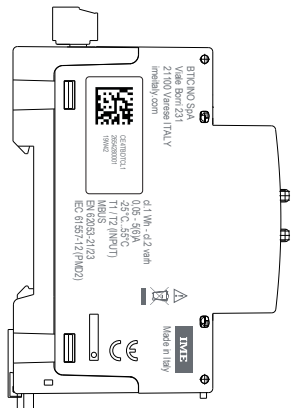
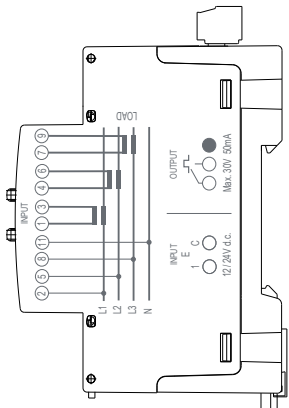
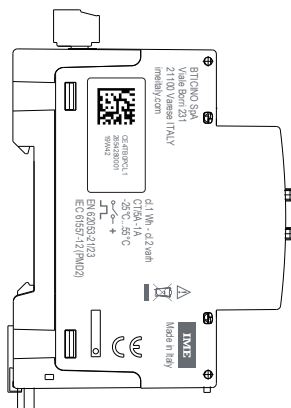
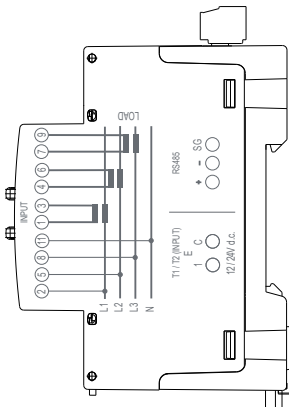

7. CARATTERISTICHE GENERALI (continua)

Display:

- Grafico retroilluminato 1,8 pollici (256x128).

Risoluzione:

- Contatori totali: 0,01kWh/kvarh
- Contatori parziali: 0,01kWh/kvarh
- Contatori tariffe: 0,01kWh/kvarh
- Rapporto TA: 1...9999
- Rapporto TV: 1,0...300,00

Indicazione massima

- Contatori totali: 9 999 999,99
- Contatori parziali: 9 999 999,99
- Contatori tariffe: 9 999 999,99

LED metrologico: 0,1Wh/imp.

Visualizzazione del valore e programmazione:

- Attraverso la tastiera frontale, 2 pulsanti.
- Modifica protetta da codice d'identificazione (**codice predefinito 1000**); il codice può essere modificato durante la procedura di programmazione.

Grandezze misurate e precisione in:

Conformità EN/IEC 62053-21

- Energia Attiva cl.1

Conformità EN/IEC 62053-23

- Energia Reattiva cl.2

Conformità EN/IEC 61557-12

- Corrente: cl.0,5
- Tensione: cl.0,5
- Frequenza: $\pm 0,1$ Hz
- Potenza totale attiva istantanea, fase, valore medio e max. valore medio: cl.1
- Potenza totale reattiva istantanea, fase: cl.2
- Potenza totale apparente istantanea, fase: cl.1
- Fattore di Potenza: cl.1

Potenza media:

- Grandezza: potenza attiva
- Calcolo: media mobile, sul periodo selezionato
- Tempo media: 5/8/10/15/20/30/60min.

Contaore:

- Conteggio di ore e minuti di funzionamento (**contatore azzerabile**)
- Risoluzione: 7 cifre (5 per le ore + 2 per i minuti)
- Visualizzazione massima: 99 999,59 (totale tariffe)
- Valore programmabile: 0...50% Pn (positiva)

Contatore di energia su TA /1A - /5A, a inserzione indiretta

Codici: CE4TBDTCL1 – CE4TB0PCL1 – CE4TBMTCL1
Modello: CONTO D4-Pt

7. CARATTERISTICHE GENERALI

Ingresso digitale

- L'ingresso digitale permette la commutazione del conteggio di energia su 2 tariffe
- 2 morsetti di ingresso con punto in comune (1 - C)
- Tensione nominale: 12 – 24V d.c. max. 10mA

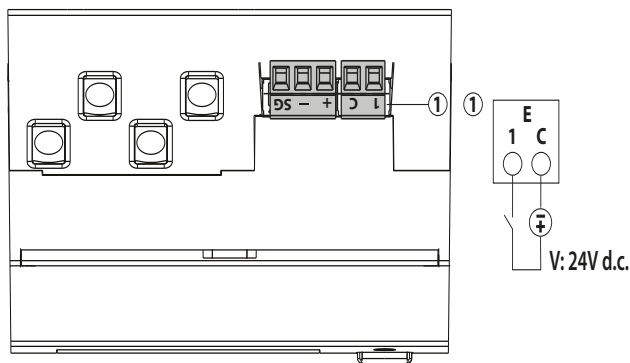

Caratteristiche della porta di comunicazione ModBus:

- Indirizzi programmabili: 1 a 255 (5*)
- Velocità di comunicazione: 4,8 – 9,6 – 19,2* – 38,4 kbps
- N°-bit: 8
- Bit di parità: nessuno, pari*, dispari
- Bit di stop: 1
- Isolata galvanicamente rispetto agli ingressi di misura
- Standard RS485 3 fili, half-duplex
- Protocollo Modbus® RTU
- Tempo di risposta (time-out domanda/risposta): ≤ 200ms
- Resistenza di terminazione da 120Ω interna allo strumento (impostabile dal menù di SETUP, valore di default none*)

Caratteristiche della porta di comunicazione MBus:

- Standard: EN 13757
- Trasmissione: asincrona seriale
- N°-bit: 8
- Bit di parità: pari fissa
- Velocità di comunicazione: 300-600-1.200-2.400*-4.800-9.600bit/s
- N° indirizzo primario: 0*...250
- N° indirizzo secondario: 0...99.999.999
- Load MBus: 1
- Isolata galvanicamente rispetto gli ingressi di misura
- Misure trasferite: vedere protocollo di comunicazione

Caratteristiche dell'uscita Impulsi:

- Optorelè con contatto SPST-NO libero da potenziale
- Tipo S0 (IEC/EN62053-31)
- Tensione U_{imp} : Max. 24V a.c./d.c.
- Corrente I_{imp} : Max. 50 mA
- Peso dell'impulso programmabile, valori possibili:
1 – 10* – 100 – 1k – 10k Wh/imp o varh/imp
- Durata impulso programmabile, valori possibili:
50 -100* – 200 – 300 – 400 – 500ms

* Configurazione di fabbrica

7. CARATTERISTICHE GENERALI

Alimentazione ausiliaria:

- Derivata dalla presa di tensione (Autoalimentato)

Temperature ambiente di funzionamento:

- Min. = - 25 °C Max. = + 55 °C

Temperature ambiente di immagazzinamento:

- Min. = - 25 °C Max. = + 70 °C
- Umidità max. 85% non condensante

Sovraccorrente di breve durata:

- 20 I_{max} per 0,5sec.

Corrente di cortocircuito:

- Test non applicabile ai contatori indiretti.

Autoconsumo circuito di tensione:

- Max. 1,5VA trifase

Autoconsumo circuito di corrente:

- Max. 1,8W per fase

Massima potenza termica dissipata per il dimensionamento termico dei quadri: ≤ 6W

Classe di protezione:

- Indice di protezione dei morsetti contro i corpi solidi e liquidi: IP 20 (IEC/EN 60529).
- Indice di protezione dell'involucro contro i corpi solidi e liquidi: IP 54 (IEC/EN 60529).

Protezione del dispositivo:

- Tramite interruttore magnetotermico e fusibile da 0,5A gG

Ambiente: meccanico M1 - elettrico E2

Materiale custodia: Policarbonato

Volume imballato: 0,60 dm³

Peso: 0,210Kg

8. CONFORMITÀ E CERTIFICAZIONI

Isolamento

- Categorie di misura: III
- Grado di inquinamento: 2
- Tensione di isolamento, Ui: 300V, Fase-Neutro

Rigidità dielettrica:

- Alimentazioni / Uscite: 4kV / 50Hz / 1min
- Involucro / Terminali: 4kV / 50Hz / 1min

Impulso:

- Alimentazioni: 6,3kV / 1,2 – 50µsec / 0,5J
- Alimentazioni / Uscite: 6,3kV / 1,2- 50µs / 0,5J

Conformità alle norme:

- Classe di precisione: Energia attiva classe 1 (EN /IEC 62053-21)
- Classe di precisione: Energia reattiva classe 2 (EN/IEC 62053-23)
- Compatibilità elettromagnetica: Prove in accordo alla EN/IEC 62052-11
- Classe di precisione in conformità alla IEC/EN61557-12

Rispetto dell'ambiente - Conformità alle direttive CEE:

- Conformità alla direttiva 2011/65/UE modificata dalla direttiva 2015/863 (RoHS 2) relativa alle limitazioni circa l'utilizzo di alcune sostanze pericolose nelle apparecchiature elettriche ed elettroniche.
- Conformità al Regolamento REACH (1907/2006): alla data di pubblicazione di questo documento, nessuna sostanza inserita nell'allegato XIV è presente all'interno di questi prodotti.
- Direttiva RAEE (2012/19/EU): la commercializzazione di questo prodotto prevede un contributo agli eco-organismi incaricati, in ciascun paese europeo, della gestione del fine vita dei prodotti che rientrano nel campo di applicazione della Direttiva Europea sui Rifiuti di Apparecchiature Elettriche ed Elettroniche.

Materie plastiche:

- Materie plastiche senza Alogeni.
- Marcatura delle parti secondo le norme ISO 11469 e ISO 1043.

Imballi:

- Progettazione e produzione degli imballi ai sensi del Decreto 98-638 del 07.20.98 e della direttiva 94/62/CE

9.COMUNICAZIONE

Schema di collegamento RS485 Modbus:

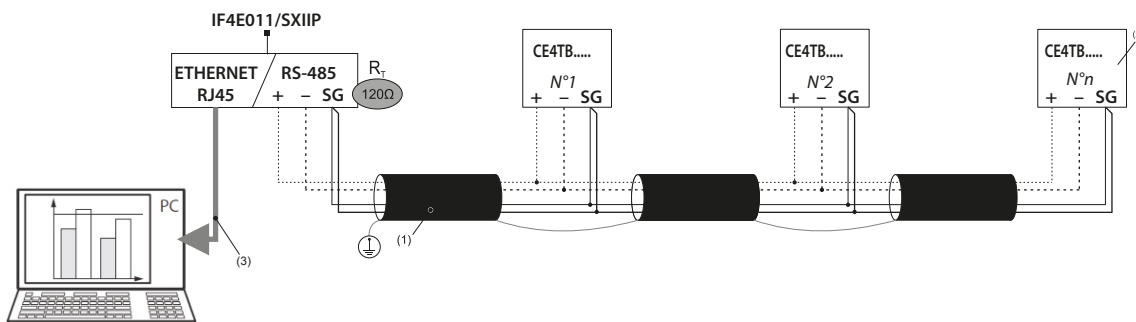

Schema di collegamento RS485 Modbus con Mini Web Server:

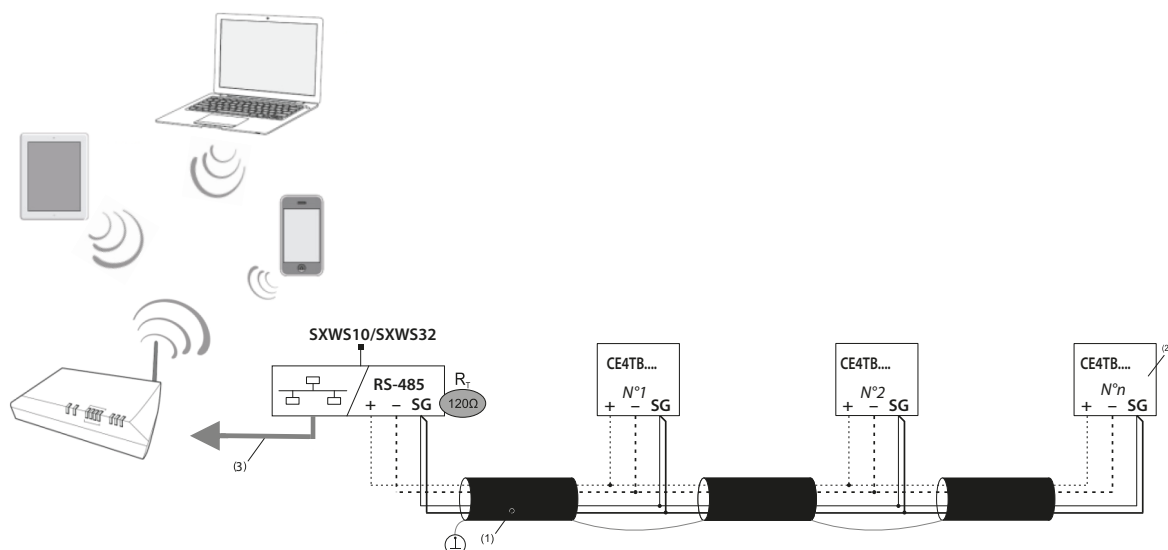

- (1) RS485: Prescritto utilizzo di cavo tipo Belden 9842, Belden 3106A (o equivalente) per una lunghezza massima del bus di 1000 m, o di cavo Categoria 6 (FTP o UTP) per una lunghezza massima di 50 m
 (2) Resistenza di terminazione da 120Ω interna allo strumento (impostabile dal menù di SETUP)
 (3) Ethernet: Cat. 6 (FTP/UTP)

Schema di collegamento Mbus:

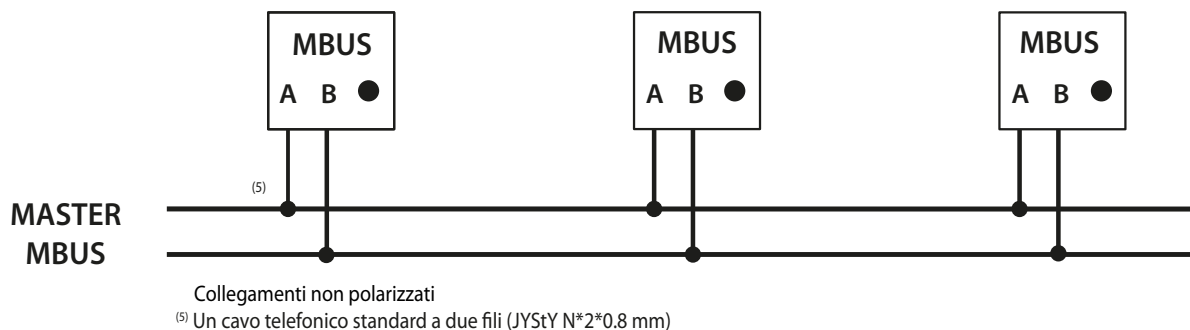

Tablelle di comunicazione

- I protocolli di comunicazione MODBUS e MBUS sono disponibile sul sito <http://www.imeitaly.com>

Energy meter on CT/1A - /5A, indirect connection

Codes: CE4TBDTCL1 – CE4TB0PCL1 – CE4TBMTCCL1
 Model: CONTO D4-Pt



Contents	Pages
1. Use	1
2. Range	1
3. Installation	1
4. Dimensions	1
5. Connections	2
6. Operating data	3
7. General features	4
8. Conformity and certifications	7
9. Communication	8

1. USE

Bidirectional active and reactive energy meter (4 quadrants). Indirect connection through /1A - /5A ratio current transformers. The device, 4 DIN modules, is self-powered and has ModBus or Mbus communication or pulse output and double tariff input. On the menu it is possible to select the device configuration for operation with the different types of connections (3N3E;3-3E;3-2E).

2. RANGE

Code Art.	In	Output	Input	Range Voltage
CE4TB0PCL1	1/5A	Pulse	Pulse	3x100V 3x230V 3x400V ± 15%
CE4TBDTCL1	1/5A	ModBus	2 Tariff / Pulse	3x100V 3x230V 3x400V ± 15%
CE4TBMTCCL1	1/5A	Mbus	2 Tariff / Pulse	3x100V 3x230V 3x400V ± 15%

3. INSTALLATION

Fixing:

On EN/IEC 60715 symmetric rail or DIN 35 rail.

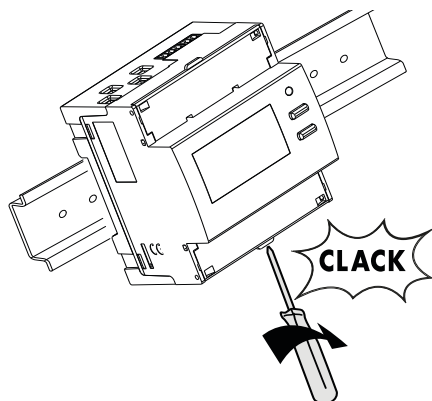

Necessary tools:

For fastening the device on the DIN rail: 5.5 mm flat screwdriver (from 4 to 6 mm).

Operating position:

Vertical, Horizontal, Upside down, On the side

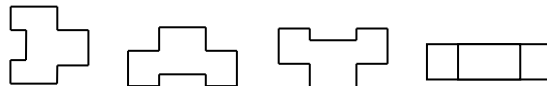

4. DIMENSIONS

Housing: 4 DIN43880 modules

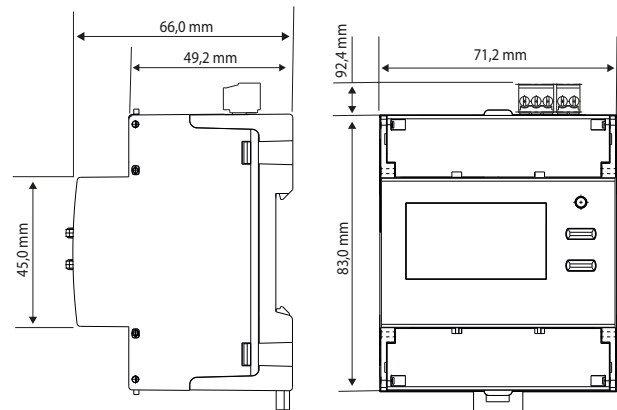

Energy meter on CT/1A - /5A, indirect connection

Codes: CE4TBDTCL1 – CE4TB0PCL1 – CE4TBMTC11
Model: CONTO D4-Pt

5. CONNECTIONS

Terminal board marking and diagram combination:

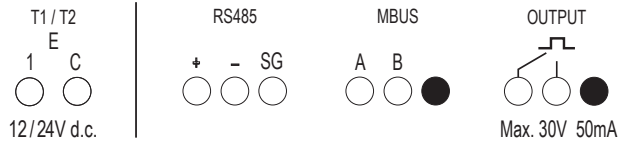

Wiring diagrams:

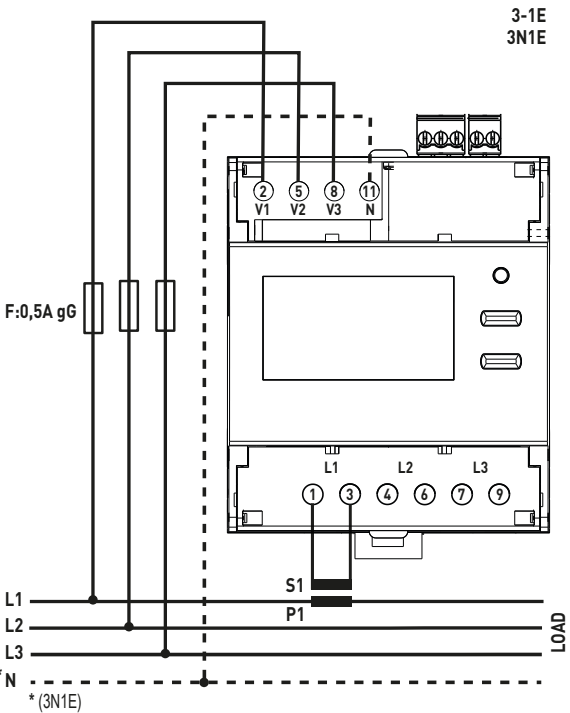
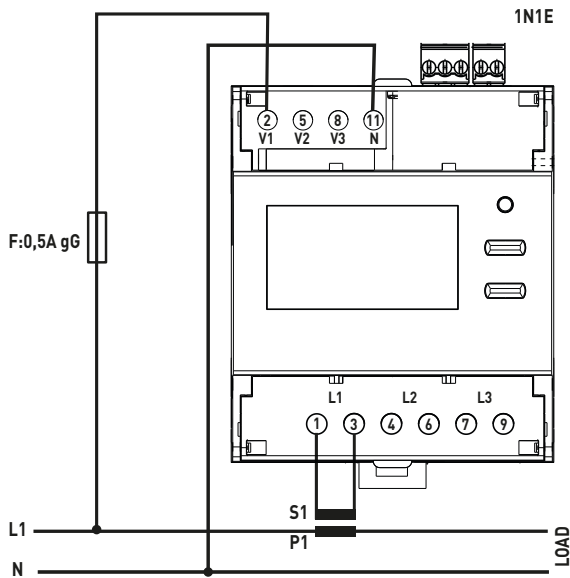

5. CONNECTIONS (continues)

Wiring diagrams:

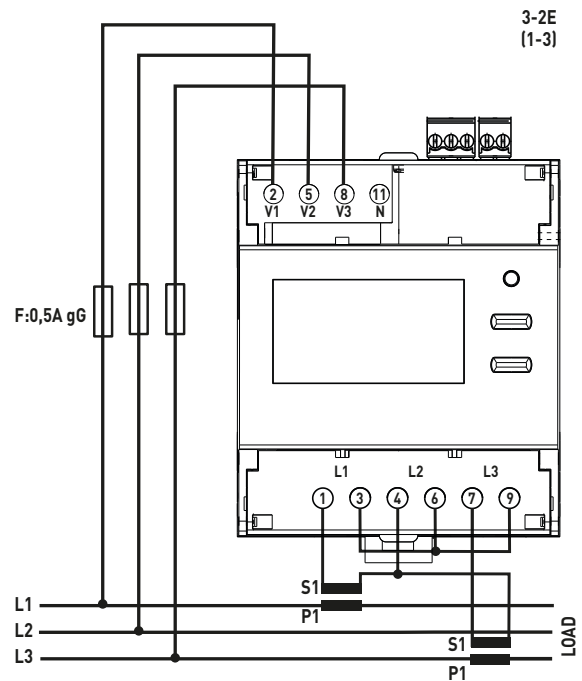
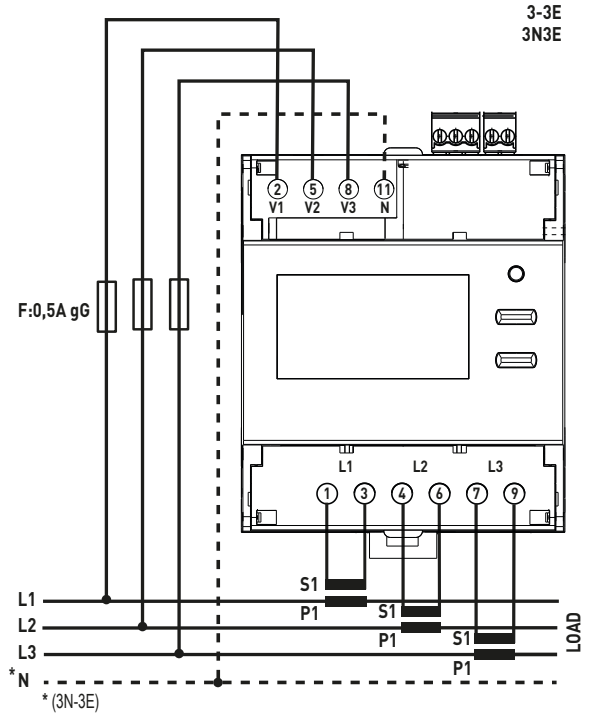

Energy meter on CT/1A - /5A, indirect connection

Codes: CE4TBDTCL1 – CE4TB0PCL1 – CE4TBMTCCL1
Model: CONTO D4-Pt

5. CONNECTIONS

Wiring diagrams:

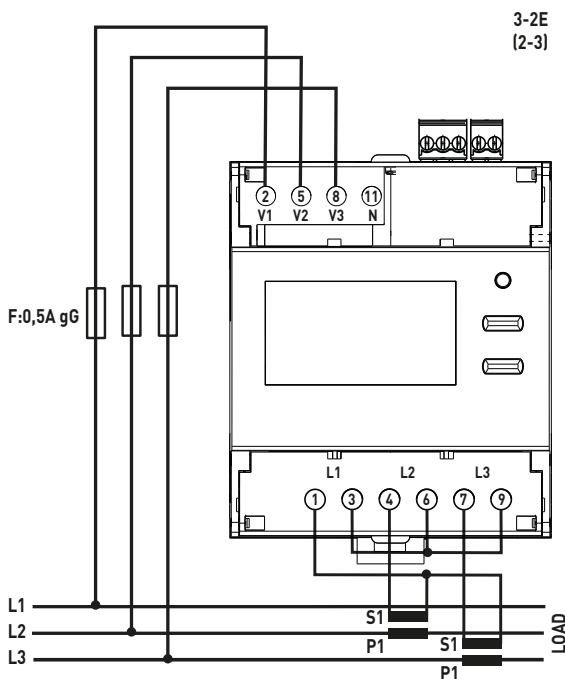
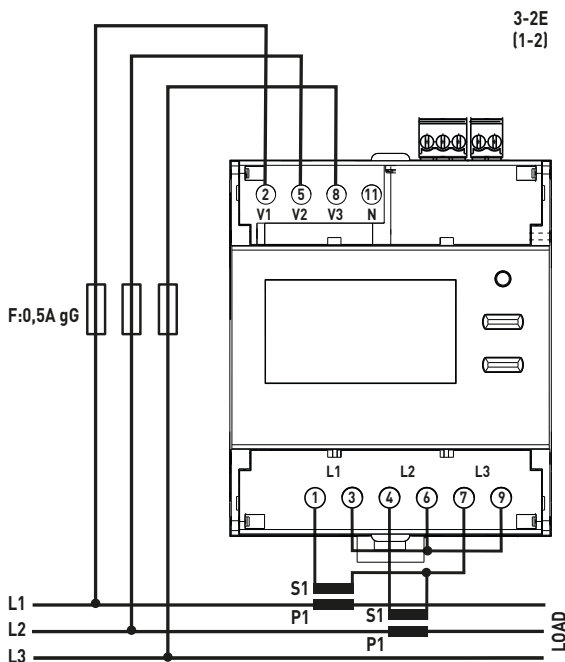

5. CONNECTIONS

Connection on VT:

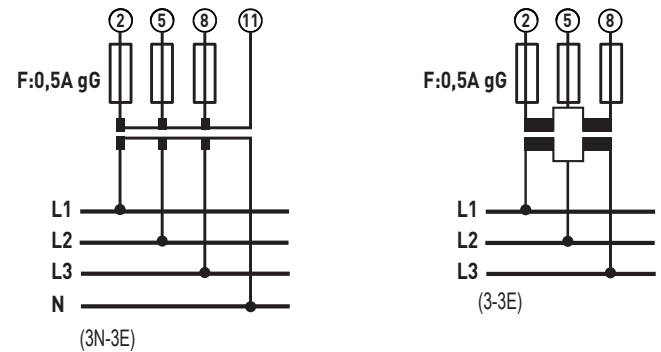

6. OPERATING DATA (continues)

6.1 ELECTRIC DATA

Currents:

- Minimum measurement current: 0,05-5(6)A / 0,01-1(1,2)A
- Starting current, I_{st} : 10mA

Rated voltages:

- Three-phase rated voltage U_n :
3x100...3x400V, 3x100/173...3x230/400V $\pm 15\%$

Rated frequency:

- F_n : 50Hz; 60Hz
- Permitted variation: 49...51Hz; 59...61Hz

Connectable section:

- Copper wires
- Voltage connection terminals (V1, V2, V3, N)
- Current connection terminals (L1, L2, L3)

	Without bush	With bush
Rigid wire	1 x 0,75 + 16 mm²	-
Flexible wire	1 x 0,75 + 16 mm² ($\varnothing 5\text{mm}$)	1 x 4 + 10 mm²

- Terminal boards in the upper part of the meter (input, impulse output and bus):

	Without bush	With bush
Rigid wire	1 x 0,2 + 1,5 mm²	-
Flexible wire	1 x 0,2 + 1 mm²	1 x 0,2 + 1 mm²

Utensili necessari:

- For all measuring terminals: screwdriver with 6mm blade or Pozidriv No. 2
- For the terminal boards in the upper part of the meter (input, impulse output and bus): screws with 2.5mm blade

Energy meter on CT/1A - /5A, indirect connection

Codes: CE4TBDTCL1 – CE4TB0PCL1 – CE4TBMTCCL1
Model: CONTO D4-Pt

6.2 MECHANICAL DATA

Screw terminals:

- Depth of the terminals: 12mm
- Lengths of the wire stripping: 11mm

Screw head:

- Voltage (V1, V2, V3, N) and current (L1, L2, L3) connection terminals: screws with countersunk head with hexagon socket and Pozidriv No. 2
- Terminal boards in the upper part of the meter (input, impulse output and bus) screws with countersunk head with hexagon socket

Recommended torque:

- Voltage connection terminals (V1, V2, V3, N): from 1.6Nm to 2Nm
- Current connection terminals (L1, L2, L3): from 1.6Nm to 2Nm
- Terminal boards in the upper part of the meter (input, impulse output and bus): 0.2 N/m

Terminal protection:

- The power terminals are protected with sliding and sealable terminal front covers which are integrated in the device

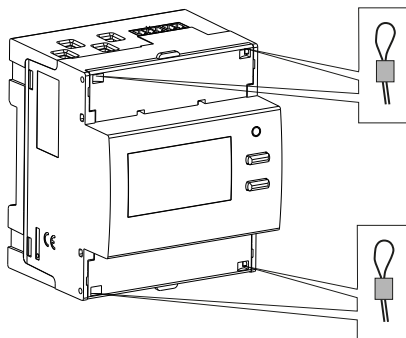

7. GENERAL FEATURES (continues)

Marking data:

Indelible marking

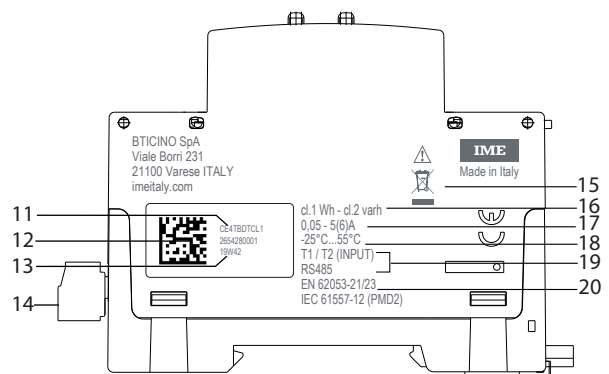
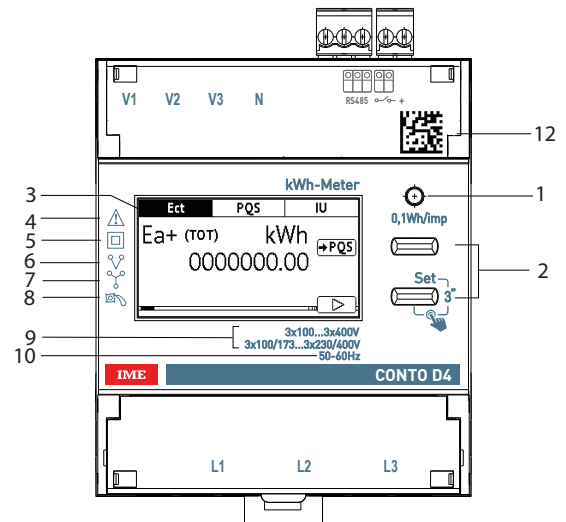

1. Metrological LED
2. Keypad made up of 2 double-function pushbuttons (display/configurations)
3. Graphic display
4. Consult the user manual before installation
5. Double insulation
6. Connection on 3-wire three-phase line
7. Connection on 4-wire three-phase line
8. Anti-rotation device (anti-decreasing)
9. Voltage
10. Frequency
11. Product code
12. Datamatrix for product traceability
13. Week and year of manufacture
14. Output connection terminals
15. RAEE Symbol
16. Precision class
17. Correnti Current
18. Temperature of use
19. Outputs
20. Standard

Energy meter on CT/1A - /5A, indirect connection

Codes: CE4TBDTCL1 – CE4TB0PCL1 – CE4TBMTCCL1
 Model: CONTO D4-Pt

7. GENERAL FEATURES

Laser marking

Left side
Traceability information

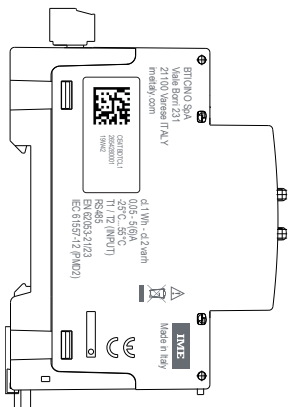

Right side
Wiring diagram

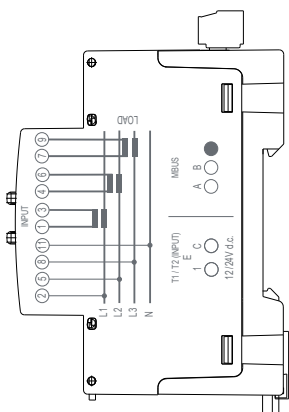
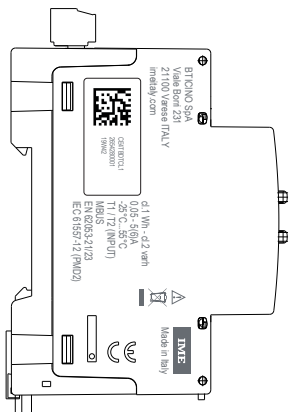
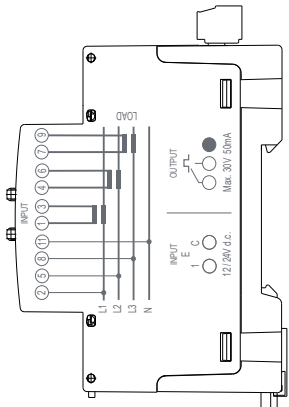
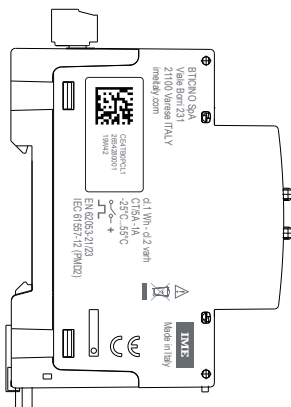
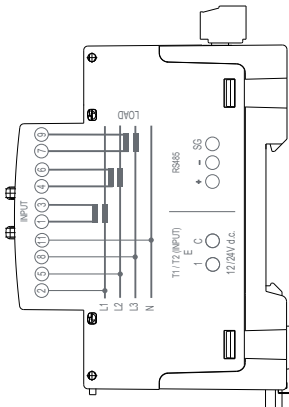

7. GENERAL FEATURES (continues)

Display:

- Graphic, backlit, 1.8 inches (256x128).

Resolution:

- Total meters: 0,01kWh/kvarh
- Partial meters: 0,01kWh/kvarh
- Tariff meters: 0,01kWh/kvarh
- CT Ratio: 1...9999
- VT Ratio: 1,0...300,00

Maximum indication

- Total meters: 9 999 999,99
- Partial meters: 9 999 999,99
- Tariff meters: 9 999 999,99

Metrological LED: 0,1Wh/imp.

Display of the value and programming:

- By means of the front keypad, 2 pushbuttons.
- Change protected by identification code (**predefined code 1000**); the code can be changed during the programming procedure.

Measurements and precision:

Conformity with EN/IEC 62053-21

- Active Energy cl.1

Conformity with EN/IEC 62053-23

- Reactive Energy cl.2

Conformity with EN/IEC 61557-12

- Current: cl.0,5
- Voltage: cl.0,5
- Frequency: $\pm 0,1$ Hz
- Instantaneous total active power, phase, average value and max. average value cl.1
- Instantaneous total active power, phase, average value and max. average value: cl.1
- Instantaneous total reactive power, phase: cl.2
- Instantaneous total apparent power, phase: cl.1
- Power Factor: cl.1

Average power:

- Measurement: active power
- Calculation: moving average, on the selected period
- Average time: 5/8/10/15/20/30/60 min.

Hour meter:

- Counting of operating hours and minutes (**resettable meter**)
- Resolution: 7 figures (5 for the hours + 2 for the minutes)
- Maximum display: 99 999.59 (tariff total)
- Programmable value: 0...50% Pn (positive)

Energy meter on CT/1A - /5A, indirect connection

Codes: CE4TBDTCL1 – CE4TB0PCL1 – CE4TBMTCCL1

Model: CONTO D4-Pt

7. GENERAL FEATURES

Digital input

- The digital input allows switching the energy counting on 2 tariffs
- 2 input terminals with common point (1 - C)
- Rated voltage: 12 – 24V d.c. max. 10mA

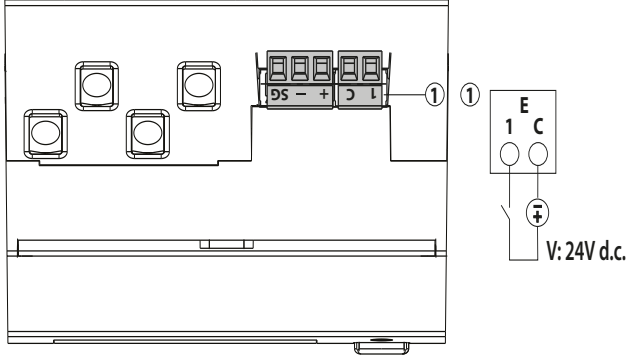

Features of the ModBus communication port:

- Programmable addresses: from 1 to 255 (5*)
- Communication speed: 4.8 – 9.6 – 19.2* – 38.4 kbps
- N°-bit: 8
- Parity bit: none, even*, odd
- Stop bit: 1
- Galvanically isolated with respect to the measurement inputs
- Standard RS485 3 wires, half-duplex
- Modbus® RTU protocol
- Response time (question/response time-out): ≤ 200ms
- 120Ω terminating resistor inside the instrument (it can be set in the SETUP menu, default value: none*)

Features of the MBus communication port:

- Standard: EN 13757
- Transmission: serial asynchronous
- No. of bit: 8
- Parity bit: fixed even
- Communication speed: 300-600-1.200-2.400*-4.800-9.600bit/s
- No. of primary address: 0*...250
- No. of secondary address: 0...99,999,999
- Load MBus: 1
- Galvanically isolated with respect to the measurement inputs
- Transferred measurements: see communication protocol

Features of the Impulse output:

- Optorelay with potential-free SPST-NO contact
- Type S0 (IEC/EN62053-31)
- Voltage Uimp: Max. 24V a.c./d.c.
- Current Iimp: Max. 50 mA
- Programmable impulse weight, possible values:
1 – 10* – 100 – 1k – 10k Wh/imp or varh/imp
- Programmable impulse duration, possible values:
50 -100* – 200 – 300 – 400 – 500msl

* Factory setting

7. GENERAL FEATURES

Auxiliary power supply:

- Shunted from the power socket (Self-supplied)

Operating room temperatures:

- Min. = - 25 °C Max. = + 55 °C

Room storage temperatures:

- Min. = - 25 °C Max. = + 70 °C
- Max.humidity. 85% non-condensing

Short-duration overcurrent:

- 20 I_{max} per 0,5sec

Short circuit current:

- Test not applicable to indirect meters.

Voltage circuit self-consumption:

- Max.1,5VA three-phase

Current circuit self-consumption:

- Max.1,8W for each phase

Maximum dissipated thermal power for the thermal dimensioning of the panels: ≤ 6W

Protection class:

- Terminal protection index against solid bodies and liquids: IP 20 (IEC/EN 60529).
- Housing protection index against solid bodies and liquids: IP 54 (IEC/EN 60529).

Protection of the device:

- By means of thermal-magnetic circuit breaker and 0.5A gG fuse

Room: mechanical M1 – electric E2

Housing material: Polycarbonate

Packaged volume: 0,60 dm³.

Wheight: 0,210Kg

8. CONFORMITY AND CERTIFICATIONS

Insulation

- Measurement categories: III
- Level of pollution: 2
- Insulation voltage, Ui: 300V, Phase-Neutral

Dielectric rigidity:

- Power supplies/ Outputs: 4kV / 50Hz / 1min
- Housing / Terminals: 4kV / 50Hz / 1min

Pulse:

- Power supplies: 6.3kV / 1.2 – 50µsec / 0.5J
- Power supplies/ Outputs: 6.3kV / 1.2- 50µs / 0.5J

In compliance with the standards:

- Precision class: Class 1 active energy (EN/IEC 62053-21)
- Precision class: Class 2 reactive energy (EN/IEC 62053-23)
- Electromagnetic compatibility: Tests in accordance with EN/IEC 62052-11
- Precision class according to IEC/EN61557-12

Respecting the environment – Conformity with the CEE directives:

- Compliance with the 2100/65/EU Directive, as modified by the 2015/863 Directive (RoHS 2), on the restriction of the use of certain hazardous substances in electrical and electronic equipment.
- Conformity with the REACH Regulation (1907/ 2006): at the date of publication of this document no substance in the annex XIV is found in these products.
- RAEE Directive (2012/19/EU: the sale of this product includes a contribution to the appointed environmental bodies of each European country in charge of handling, at the end of their life, the products falling within the scope of the EU Directive on Electric and Electronic Equipment Waste.

Plastic materials:

- Plastic materials without Halogens.
- Part marking according to standards ISO 11469 and ISO 1043.

Packaging:

- Packaging designed and produced in accordance with Decree 98-638 of 07.20.98 and directive 94/62/CE

9. COMMUNICATION

RS485 Modbus wiring diagram:

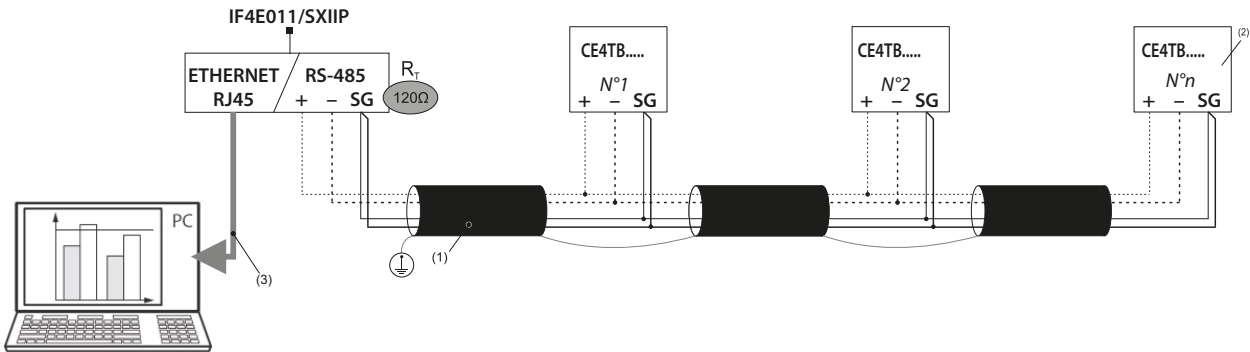

RS485 Modbus wiring diagram with Mini Web Server:

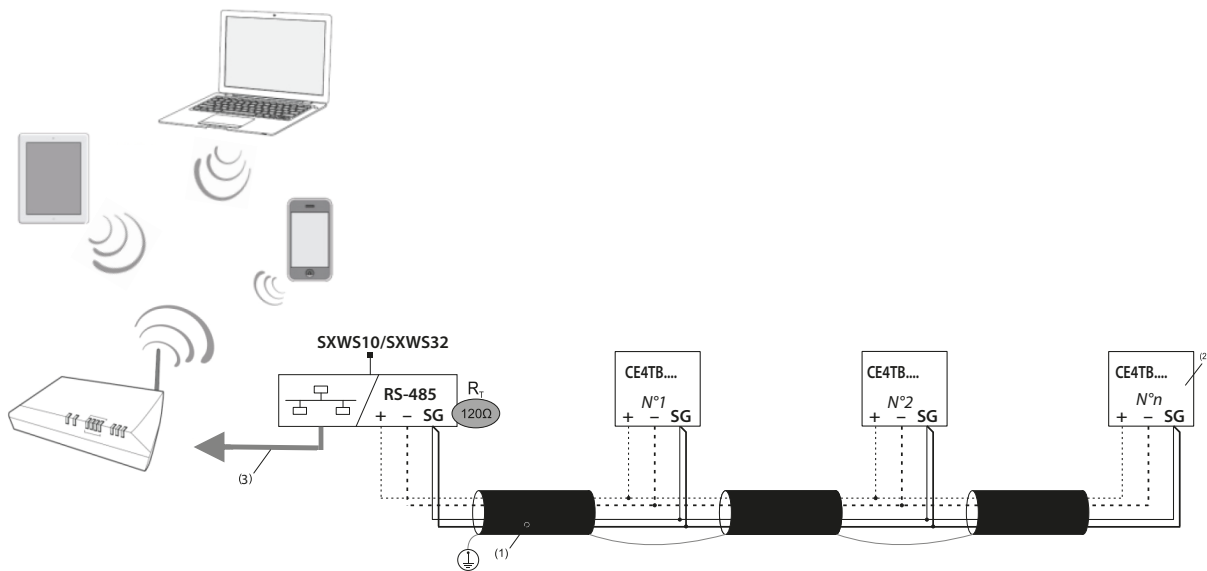

- (1) RS485: Required use of Belden 9842 or Belden 3106A wire (or equivalent) for a maximum bus length of 1000 m, or Category 6 wire (FTP or UTP) for a maximum length of 50 m
- (2) 120Ω terminating resistor inside the instrument (it can be set in the SETUP menu)
- (3) Ethernet: Cat. 6 (FTP/UTP)

Mbus wiring diagram:

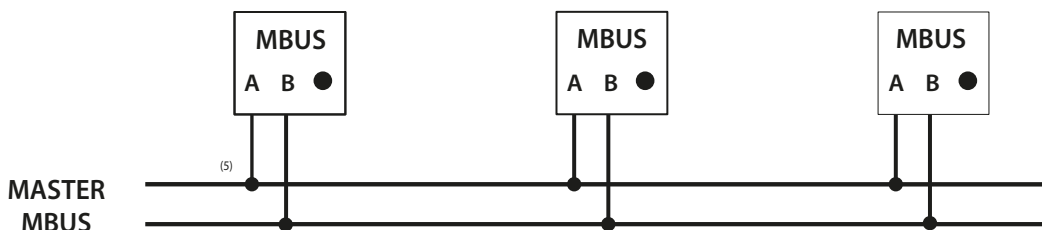

Non-polarized connections
(5) A two-wire standard telephone cable (JYStY N°2*0.8 mm)

Communication tables

- The MODBUS and MBUS communication protocols are available on the <http://www.imeitaly.com>

Compteur d'énergie sur CT/1A - /5A, à raccordement indirect

Réf.: CE4TBDTCL1 – CE4TB0PCL1 – CE4TBMTC1
 Modèle: CONTO D4-Pt



Sommaire	Pages
1. Utilisation.....	1
2. Gamme.....	1
3. Installation.....	1
4. Dimensions.....	1
5. Connexions.....	2
6. Données de fonctionnement.....	3
7. Caractéristiques générales.....	4
8. Conformité et certifications.....	7
9. Communication.....	8

1. UTILISATION

Compteur d'énergie bidirectionnelle active et réactive (4 quadrants). Connexion indirecte via Transformateurs de courant avec rapport /1A - /5A. Le dispositif, en 4 modules DIN, est auto-alimenté et est doté de communication ModBus ou Mbus ou d'une sortie impulsionnelle et d'entrée double tarif. Le menu permet de configurer le dispositif pour le fonctionnement dans les différents types de connexion (3N3E, 3-3E et 3-2E).

2. GAMME

Code Réf.	In	Sorties	Entrées	Plage de tension
CE4TB0PCL1	1/5A	Impulsions	Impulsions	3x100V 3x230V 3x400V ± 15%
CE4TBDTCL1	1/5A	ModBus	2 Tarif / Impulsions	3x100V 3x230V 3x400V ± 15%
CE4TBMTC1	1/5A	Mbus	2 Tarif / Impulsions	3x100V 3x230V 3x400V ± 15%

3. INSTALLATION

Fixation:

Sur rail symétrique EN/IEC 60715 ou guide DIN 35.

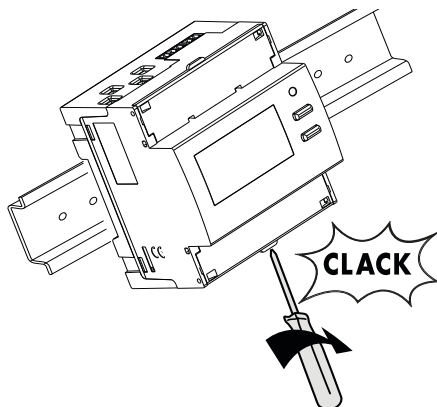

Outillages nécessaires:

Pour la fixation du dispositif sur guide DIN : tournevis plat de 5,5 mm (de 4 à 6 mm)

Position de fonctionnement :

Verticale, horizontale, dessus/dessous, latérale

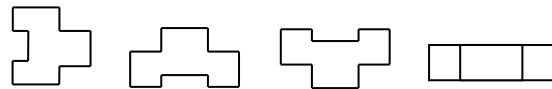

4. DIMENSIONS

Boîtier: 4 modules DIN43880

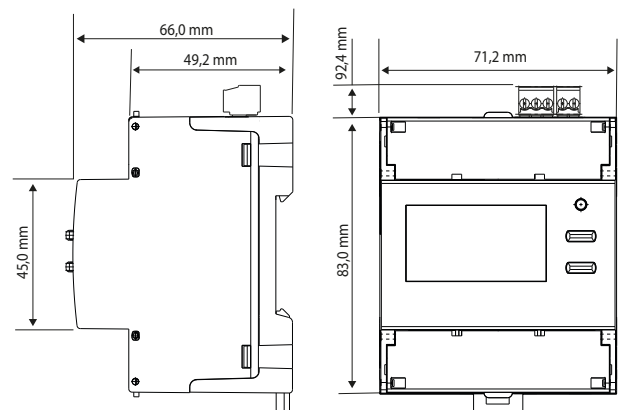

Compteur d'énergie sur CT/1A - /5A, à raccordement indirect

Réf.: CE4TBDTCL1 – CE4TB0PCL1 – CE4TBMTC1

Modèle: CONTO D4-Pt

5. CONNEXIONS - BRANCHEMENT

Marquage borniers et combinaison schémas:

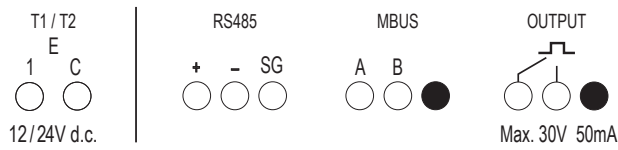

Schémas raccordement:

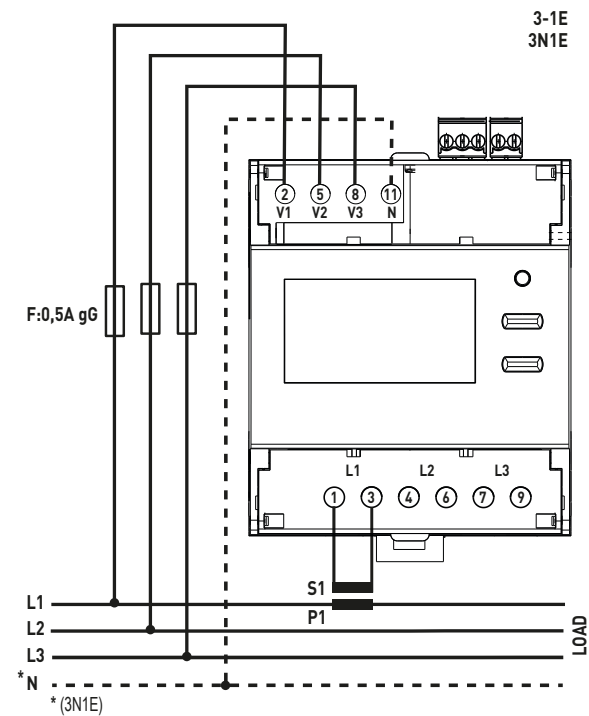
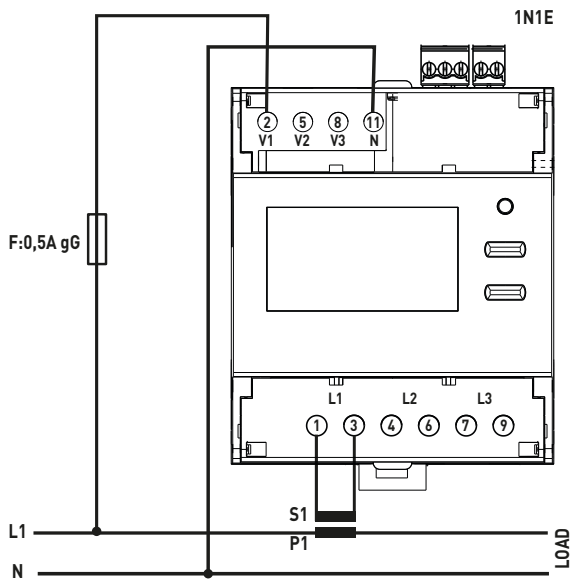

5. CONNEXIONS - BRANCHEMENT (continue)

Schémas raccordement:

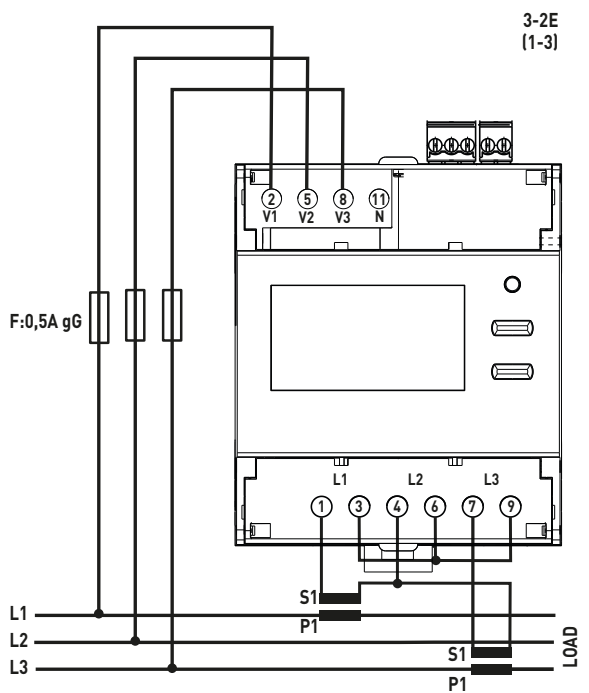
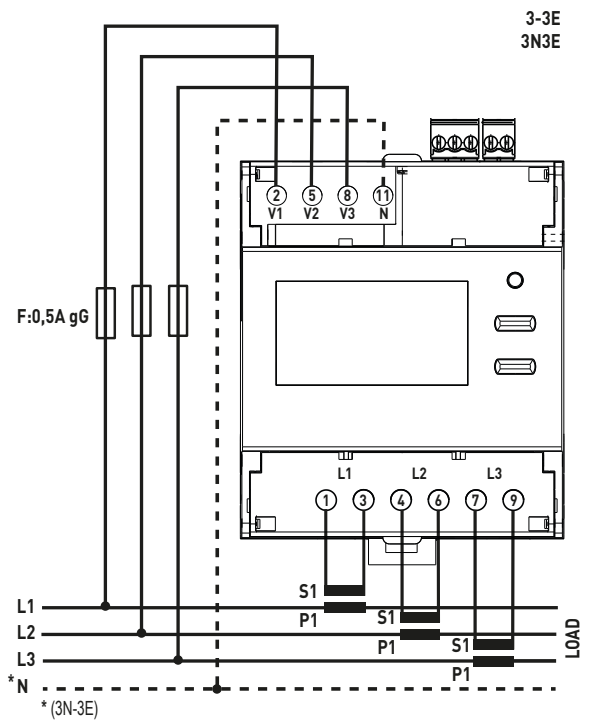

Compteur d'énergie sur CT/1A - /5A, à raccordement indirect

Réf.: CE4TBDTCL1 – CE4TB0PCL1 – CE4TBMTCCL1
Modèle: CONTO D4-Pt

5. CONNEXIONS - BRANCHEMENT

Schémas raccordement :

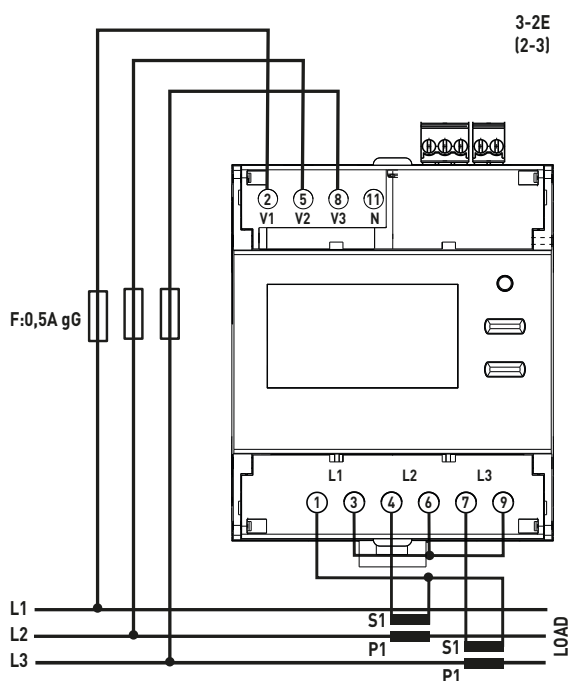
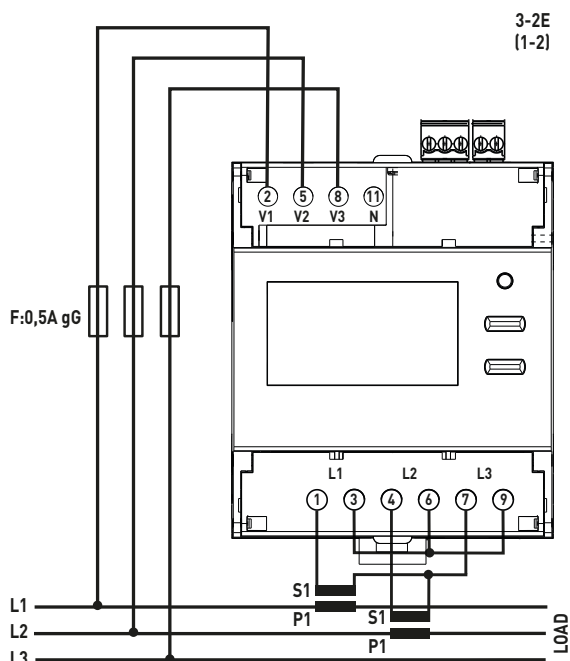

5. CONNEXIONS - BRANCHEMENT

Activation sur VT:

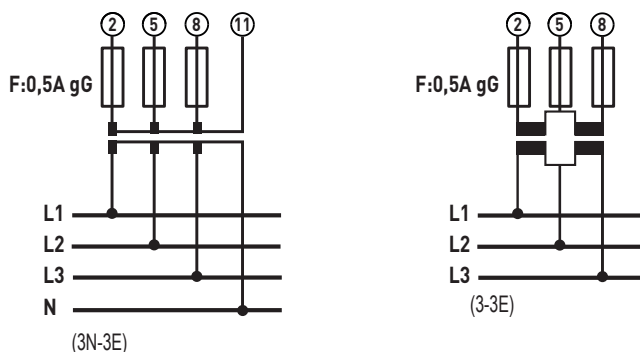

6. DONNÉES DE FONCTIONNEMENT (continue)

6.1 ELECTRIQUE

Courants:

- Courant minimum de mesure: 0,05-5(6)A / 0,01-1(1,2)A
- Courant de démarrage, I_{st} : 10mA

Tensions nominales:

- Tension triphasée nominale U_n : 3x100...3x400V, 3x100/173...3x230/400V $\pm 15\%$

Fréquence nominale:

- F_n : 50Hz; 60Hz
- Variation admise: 49...51Hz; 59...61Hz

Section connectable:

- Câbles en cuivre
- Bornes de branchement des tensions (V1, V2, V3, N)
- Bornes de branchement des courants (L1, L2, L3)

	Sans douille	Avec douille
Câble rigide	1 x 0,75 + 16 mm²	-
Câble flexible	1 x 0,75 + 16 mm² (∅ 5mm)	1 x 4 + 10 mm²

- Borniers sur la partie supérieure du compteur (entrée, sortie impulsions et bus)

	Sans douille	Avec douille
Câble rigide	1 x 0,2 + 1,5 mm²	-
Câble flexible	1 x 0,2 + 1 mm²	1 x 0,2 + 1 mm²

Outils nécessaires :

- Pour les bornes de branchement de mesure: tournevis plat de 6mm ou Pozidriv n°2
- Pour les borniers sur la partie supérieure du compteur (entrée, sortie impulsions et bus): tournevis plat de 2,5 mm

Compteur d'énergie sur CT/1A - /5A, à raccordement indirect

Réf.: CE4TBDTCL1 – CE4TB0PCL1 – CE4TBMTC11

Modèle: CONTO D4-Pt

6.2 MECANIQUE

Bornes à vis:

- Profondeur des bornes : 12mm
- Longueur des dénudages du câble : 11mm

Tête de la vis :

- Bornes de branchement des tensions (V1, V2, V3, N) et courants (L1, L2, L3) : vis à tête mixte à entaille et Pozidriv n°2
- Borniers sur la partie supérieure du compteur (entrée, sortie impulsions et bus): vis à tête à entaille.

Couple de serrage recommandé :

- Bornes de branchement des tensions (V1,V2,V3,N): de 1,6Nm à 2Nm
- Bornes de branchement des courants(L1, L2, L3): de 1,6Nm à 2Nm
- Borniers sur la partie supérieure du compteur (entrée, sortie impulsions et bus): 0,2 N/m

Protection des bornes :

- Les bornes de puissance sont protégées par des caches coulissants et isolables intégrés au dispositif.

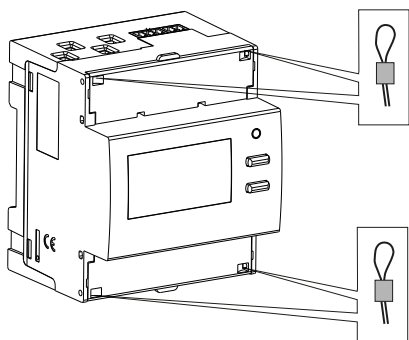

7. CARACTÉRISTIQUES GÉNÉRALES (continue)

Données de marquage:

Marquage indélébile

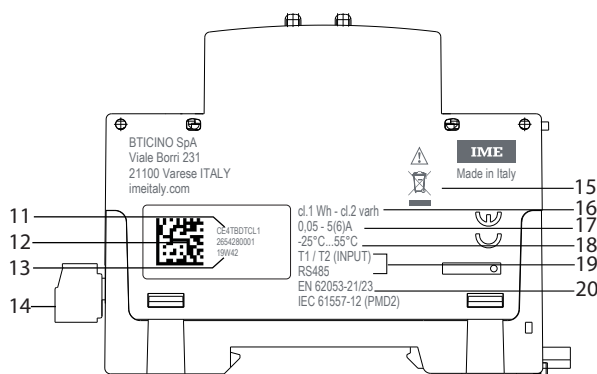
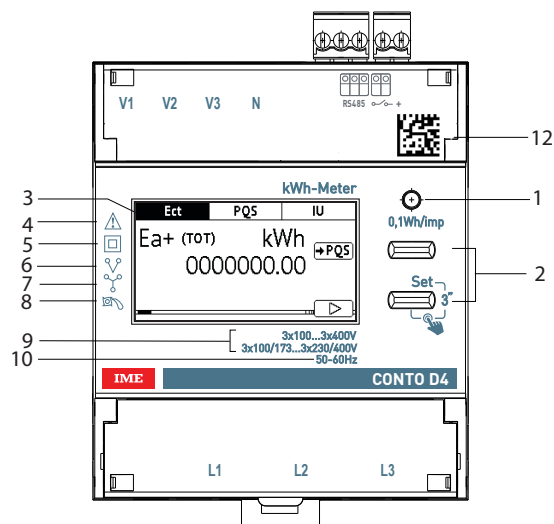

1. LED métrologique
2. Clavier constitué de 2 boutons à deux fonctions (visualisation/configuration)
3. Écran graphique
4. Consulter le manuel d'utilisation avant de procéder à l'installation.
5. Double isolation
6. Activation sur ligne triphasés 3 fils
7. Activation sur ligne triphasés 4 fils
8. Dispositif anti-rotation (anti-diminution)
9. Tension
10. Fréquence
11. Code produit
12. Datamatrix pour traçabilité produit
13. Semaine et année de fabrication
14. Bornes de branchement sorties
15. Symbole DEEE
16. Classe de précision
17. Courant
18. Température d'utilisation
19. Sorties
20. Norme

Compteur d'énergie sur CT/1A - /5A, à raccordement indirect

Réf.: CE4TBDTCL1 – CE4TB0PCL1 – CE4TBMTC11
Modèle: CONTO D4-Pt

7. CARACTÉRISTIQUES GÉNÉRALES

Marquage au laser

Côté gauche

Informations de traçabilité

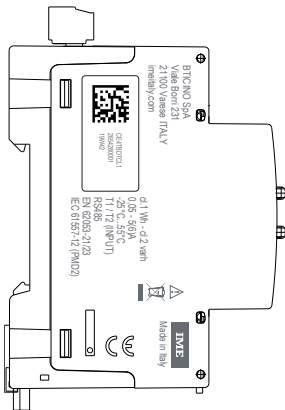

Côté droit

Schéma de branchement

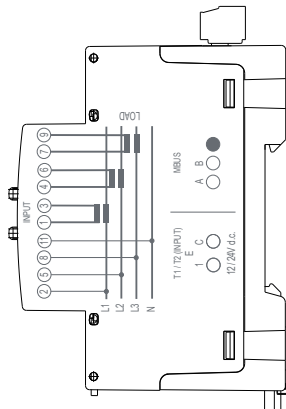
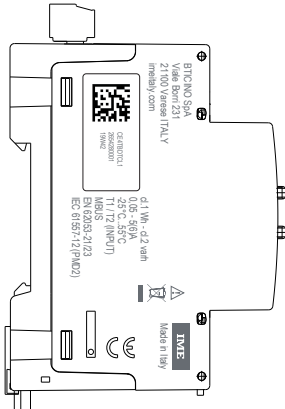
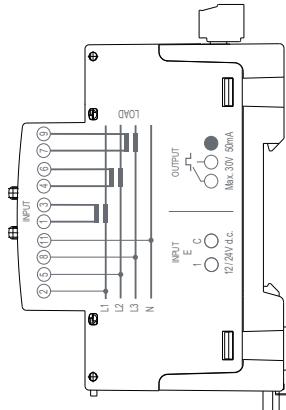
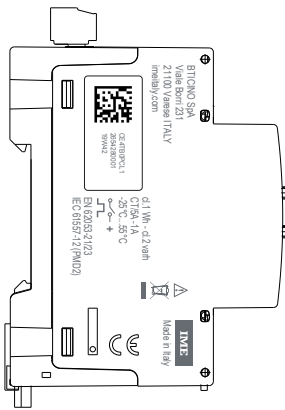
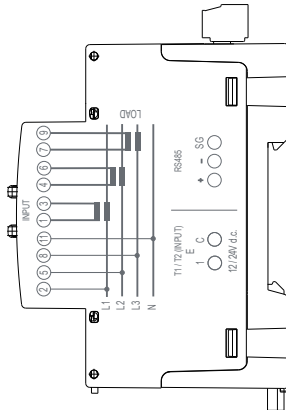

7. CARACTÉRISTIQUES GÉNÉRALES (continue)

Écran:

- Graphique à rétroéclairage 1,8 pouces (256x128).

Résolution:

- Compteurs total: 0,01kWh/kvarh
- Compteurs partiel: 0,01kWh/kvarh
- Compteurs tarifs : 0,01kWh/kvarh
- Rapport CT: 1...9999
- Rapport VT: 1,0...300,00

Affichage maximum :

- Compteurs total: 9 999 999,99
- Compteurs partiel : 9 999 999,99
- Compteurs tarifs : 9 999 999,99

LED métrologique : 0,1Wh/imp.

Visualisation de la valeur et programmation:

- Avec le clavier frontal, 2 boutons.
- Modification protégée par un code d'identification (**code prédéfini 1000**) ; le code peut être modifié pendant la procédure de programmation.

Grandeurs mesurées et précision en:

Conformité EN/IEC 50470-1 -3

- Énergie active: cl. B

Conformité EN/IEC 62053-23

- Énergie réactive : cl. 2

Conformité EN/IEC 61557-12

- Courant : cl.0,5
- Tension: cl.0,5
- Fréquence: $\pm 0,1$ Hz
- Puissance totale active instantanée, phase, valeur moyenne et valeur moyenne max.: cl.1
- Puissance totale réactive instantanée, phase cl.2
- Puissance totale apparente instantanée, phase: cl.1
- Facteur de puissance : cl.1

Puissance moyenne :

- Grandeur: puissance active
- Calcul: moyenne mobile, sur la période sélectionnée
- Temps moyen: 5/8/10/15/20/30/60min.

Totalisateur horaire :

- Décompte heures et minutes de fonctionnement (**totalisateur pouvant être remis à zéro**)
- Résolution : 7 chiffres (5 pour les heures + 2 pour les minutes)
- Visualisation maximum : 99 999,59 (total tarifs)
- Valeur programmable : 0...50% Pn (positive)

Compteur d'énergie sur CT/1A - /5A, à raccordement indirect

Réf.: CE4TBDTCL1 – CE4TB0PCL1 – CE4TBMTCL1
Modèle: CONTO D4-PT

7. CARACTÉRISTIQUES GÉNÉRALES

Entrée numérique

- L'entrée numérique permet la commutation du décompte de l'énergie sur 2 tarifs.
- 2 bornes d'entrée avec point commun (1 - C)
- Tension nominale : 12 – 24V d.c. max. 10mA

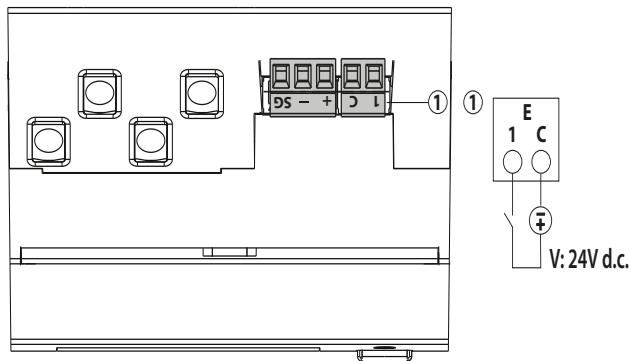

Caractéristiques du port de communication ModBus :

- Adresses programmables : de 1 à 255 (5*)
- Vitesse de communication : 4,8 – 9,6 – 19,2* – 38,4 kbps
- N°-bit : 8
- Bit de parité : aucune parité, paire*, impaire
- Bit de stop : 1
- A isolation galvanique par rapport aux autres entrées de mesure
- Standard RS485 3 fils, half-duplex
- Protocole Modbus® RTU
- Temps de réponse (time-out demande/réponse) : ≤ 200 ms
- Résistance de terminaison de 120 Ω intégrée à l'instrument (réglable dans le menu de RÉGLAGE, valeur par défaut « none »*)

Caractéristiques du port de communication MBus:

- Standard : EN 13757
- Transmission : asynchrone sérielle
- N°-bit : 8
- Bit de parité : paire*, fixe
- Vitesse de communication: 300-600-1.200-2.400*-4.800-9.600bit/s
- N° adresse primaire : 0*...250
- N° adresse secondaire : 0...99 999 999
- Load MBus : 1
- A isolation galvanique par rapport aux autres entrées de mesure
- Mesures transférées : voir protocole de communication

Caractéristiques de la sortie à Impulsions :

- Opto-relai à contact SPST-NO libre de potentiel
- Type S0 (IEC/EN62053-31)
- Tension Uimp: Max. 24V a.c./d.c.
- Courant Iimp: Max. 50 mA
- Poids de l'impulsion programmable, valeurs possibles: 1 – 10* – 100 – 1k – 10k Wh/imp ou varh/imp
- Durée de l'impulsion programmable, valeurs possibles: 50 -100* – 200 – 300 – 400 – 500ms

* Configuration par défaut

7. CARACTÉRISTIQUES GÉNÉRALES

Alimentation auxiliaire :

- Dérivée de la prise de tension (Auto-alimentée)

Température ambiante de fonctionnement :

- Min. = - 25 °C Max. = + 55 °C

Température ambiante de stockage :

- Min. = - 25 °C Max. = + 70 °C
- Humidité max. 85% sans condensation.

Surintensité de courte durée :

- 20 I_{max} per 0,5sec.

Courant de court-circuit:

- Test non applicable aux compteurs indirects.

Autoconsommation circuit de tension:

- Max.1,5VA triphasée

Autoconsommation circuit de courant:

- Max.1,8W par phase

Puissance thermique maximale dissipée pour le dimensionnement des tableaux : ≤ 6 W

Classe de protection :

- Indice de protection des bornes contre les corps solides et les liquides: IP 20 (IEC/EN 60529).
- Indice de protection de l'habillage contre les corps solides et les liquides: IP 54 (IEC/EN 60529).

Protection du dispositif :

- Avec disjoncteur magnéto-thermique et fusible de 0,5A gG

Environnement: mécanique M1 - électrique E2

Matériau habillage: Polycarbonate

Volume emballé : 0,60 dm³.

Poids: 0,210Kg

8. CONFORMITÉ ET CERTIFICATIONS

Isolation

- Catégories de mesure : III
- Degré de pollution : 2
- Tension d'isolation, U_i : 300 V Phase-Neutre

Rigidité diélectrique :

- Alimentation / Sorties : 4kV / 50Hz / 1min
- Habillage / Terminaisons : 4kV / 50Hz / 1min

Impulsion:

- Alimentations : 6,3kV / 1,2 – 50µsec / 0,5J
- Alimentation / Sorties : 6,3kV / 1,2- 50µs / 0,5J

Conformité aux normes:

- Classe de précision : Énergie active : classe 1 (EN/IEC 62053-21)
- Classe de précision : Énergie réactive : classe 2 (EN/IEC 62053-23)
- Compatibilité électromagnétique : Essais conformément à la norme EN/IEC 62052-11
- Classe de précision conforme à la norme IEC/EN61557-12

Respect de l'environnement - Conformité aux directives CEE:

- Conformité à la directive 2011/65/UE modifiée par la directive 2015/863 (RoHS 2) relative aux limitations imposées à l'utilisation de certaines substances dangereuses dans les équipements électriques et électroniques.
- Conformité au règlement REACH (1907/2006) : à la date de publication du présent document, aucune substance mentionnée dans l'annexe XIV n'est présente dans les produits.
- Directive DEEE (2012/19/EU): la commercialisation du produit prévoit une contribution aux organismes écologiques en charge, dans chaque pays européen, de la gestion de la fin du cycle de vie des produits qui rentrent dans le champ d'application de la Directive européenne sur les déchets d'équipements électriques et électroniques.

Matériaux plastiques:

- Matériaux plastiques sans halogènes.
- Marquage des parties conforme aux normes ISO 11469 et ISO 1043.

Emballages:

- Conception et production des emballages conformes au Décret 98-638 du 20.07.98 et à la directive 94/62/CE.

9. COMMUNICATION

Schéma de branchement RS485 Modbus:



Schéma de branchement RS485 Modbus avec Mini Web Server:



(1) RS485: Utilisation prescrite de câble Belden 9842, Belden 3106A (ou équivalent) pour une longueur maximum du bus de 1000 m ou de câble de Catégorie 6 (FTP ou UTP) pour une longueur maximum de 50 m.

(2) Résistance de terminaison de 120 Ω intégrée à l'instrument (réglable dans le menu de RÉGLAGE)

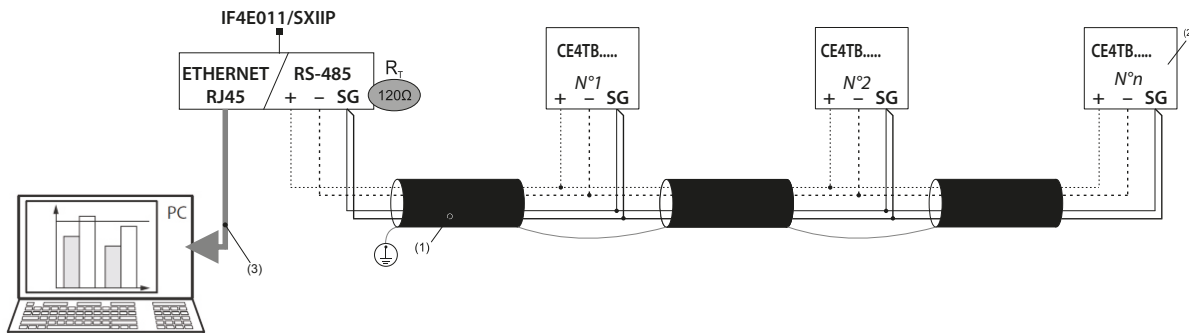
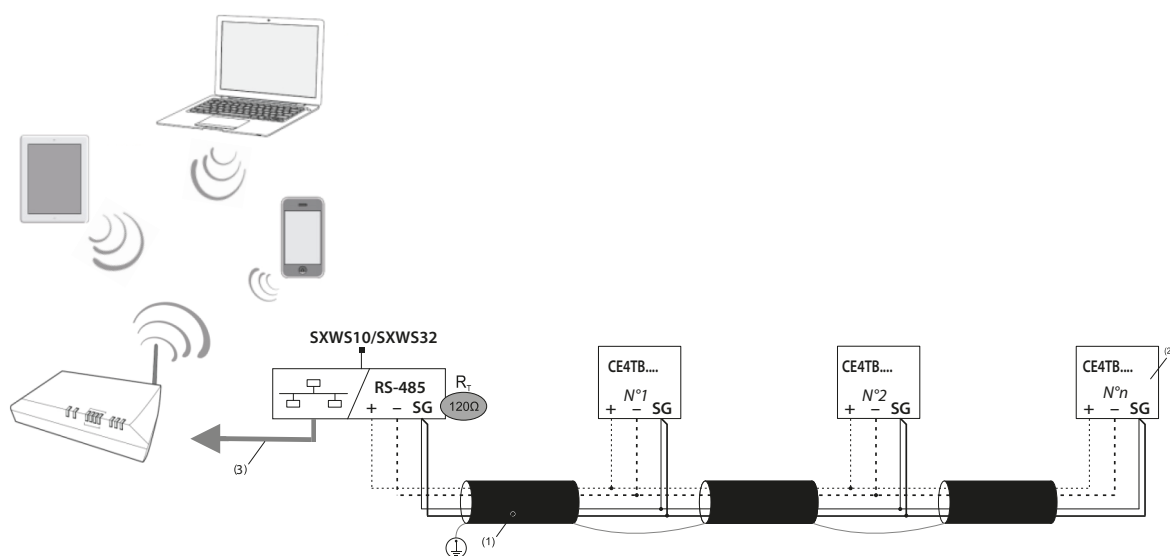
(3) Ethernet: Cat. 6 (FTP/UTP)

Schéma de branchement Mbus:

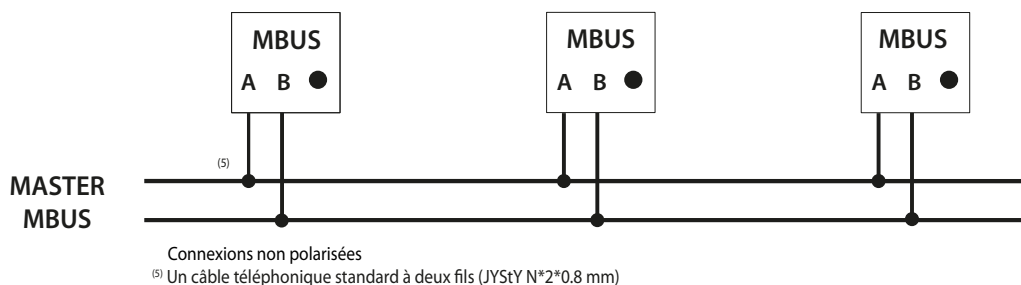

Tables de communication

- Les protocoles de communication MODBUS et MBUS sont disponibles sur le site <http://www.imeitaly.com>

Energiezähler bis CT/1A - /5A, Indirektanschluss

Codes: **CE4TBDTCL1 – CE4TB0PCL1 – CE4TBMTCCL1**
 Modell: **CONTO D4-Pt**



Inhaltsverzeichnis	Seiten
1. Gebrauch.....	1
2. Baureihe	1
3. Installation	1
4. Abmessungen	1
5. Verbindungen	2
6. Betriebsdaten	3
7. Allgemeine Eigenschaften	4
8. Konformität und Zertifizierungen.....	7
9. Kommunikation.....	8

1. GEBRAUCH

Wirk- und Blind bidirektionalen Energiezähler (4 Quadranten), mit Wandleranschluss /1A oder /5A und Anzahl der importierten und exportierten Energie (Ea+, Ea-, Er+, Er-). Das Gerät ist in einem 4TE DIN-Gehäuse untergebracht, selbstversorgt und mit Schnittstelle – RS485 (ModBus) oder M-Bus – oder impulsausgang und Doppeltarif-eingang ausgestattet. Im Menü können Sie die folgenden Netzart wählen- 3N3E; 3-3E; 3-3E; 3-2E!

2. BAUREIHE

Artikelcode	In	Ausgänge	Eingänge	Spannungsbereich
CE4TB0PCL1	1/5A	Impulse	Impulse	3x100V 3x230V 3x400V ± 15%
CE4TBDTCL1	1/5A	ModBus	Doppeltarif / Impulse	3x100V 3x230V 3x400V ± 15%
CE4TBMTCCL1	1/5A	Mbus	Doppeltarif / Impulse	3x100V 3x230V 3x400V ± 15%

3. INSTALLATION

Schraubenbefestigung:

An einer EN/IEC 60715 symmetrischen Schiene oder DIN 35.

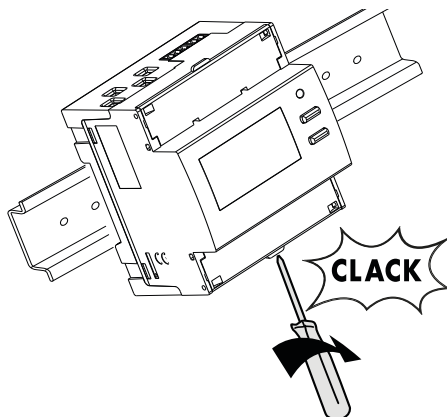

Erforderliche Werkzeuge:

Zur Befestigung des Geräts an die DIN Schiene:
 Flachschraubendreher 5.5 mm (4 bis 6mm)

Betriebsposition:

Vertikal, horizontal, umgedreht, an der Seite

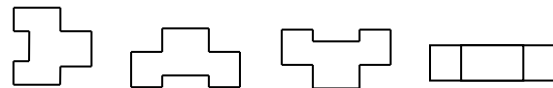

4. ABMESSUNGEN

Gehäuse: 4 Module DIN43880

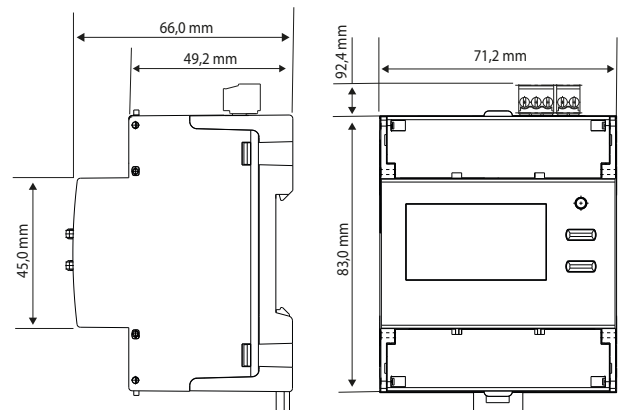

Energiezähler bis CT/1A - /5A, Indirektanschluss

Codes: CE4TBDTCL1 – CE4TB0PCL1 – CE4TBMTC1
Modell: CONTO D4-Pt

5. VERBINDUNGEN - ANSCHLUSS

Markierung der Klemmleisten und Kombination der Anschlussbilder:

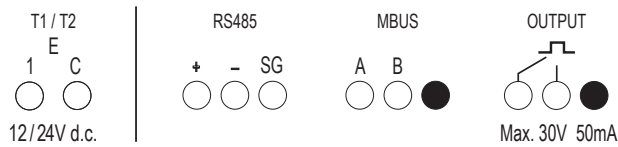

Anschlussbilder:

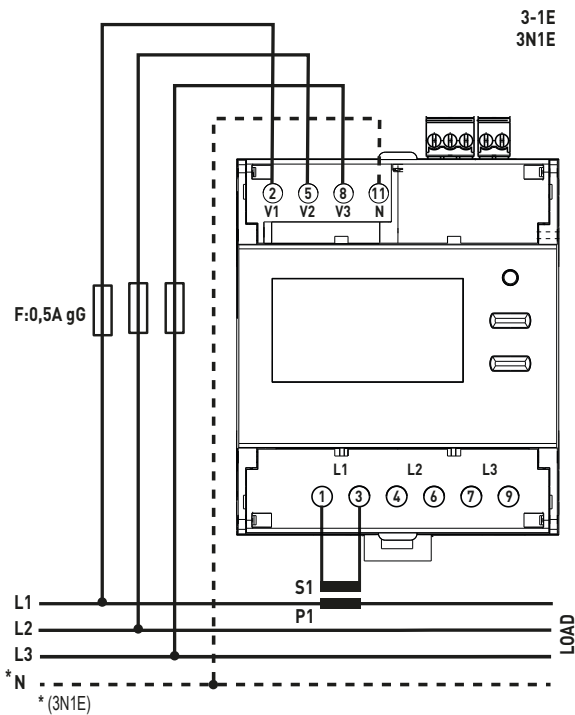
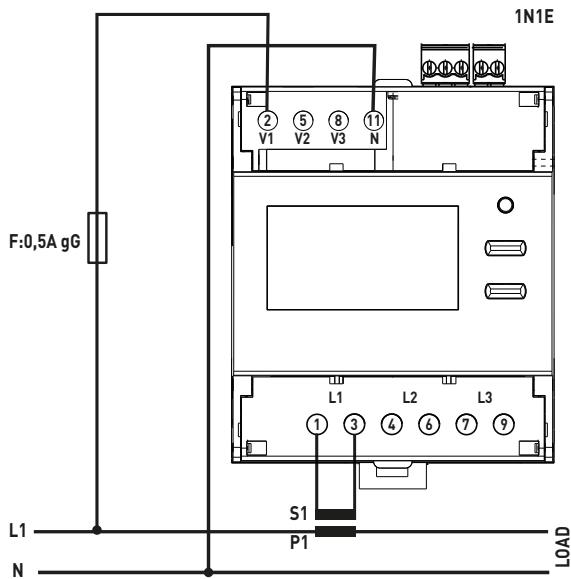

5. VERBINDUNGEN – ANSCHLUSS (Fortsetzung)

Anschlussbilder:

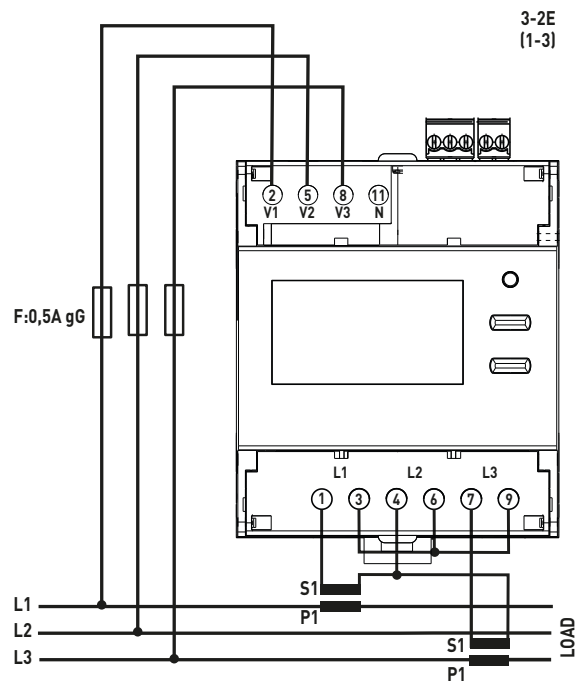
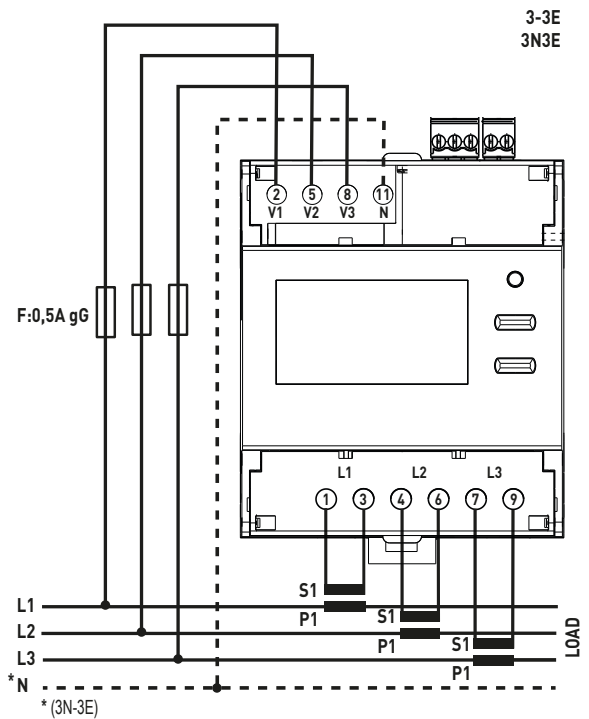

Energiezähler bis CT/1A - /5A, Indirektanschluss

Codes: CE4TBDTCL1 – CE4TB0PCL1 – CE4TBMTCCL1
Modell: CONTO D4-Pt

5. VERBINDUNGEN - ANSCHLUSS

Anschlussbilder:

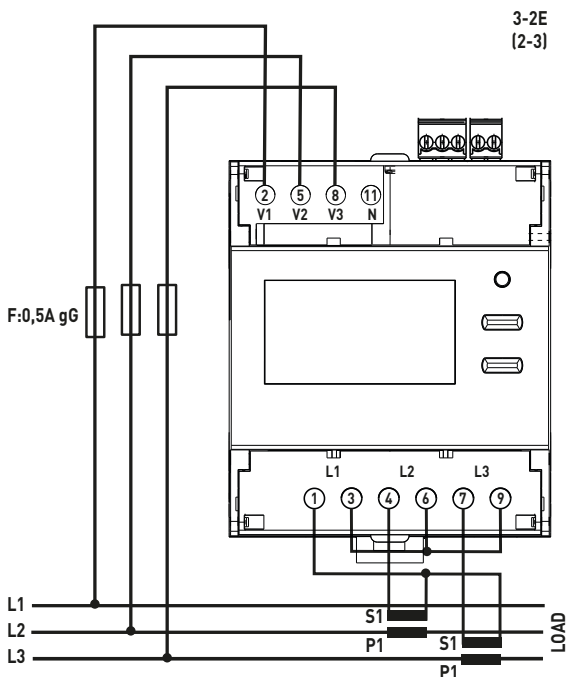
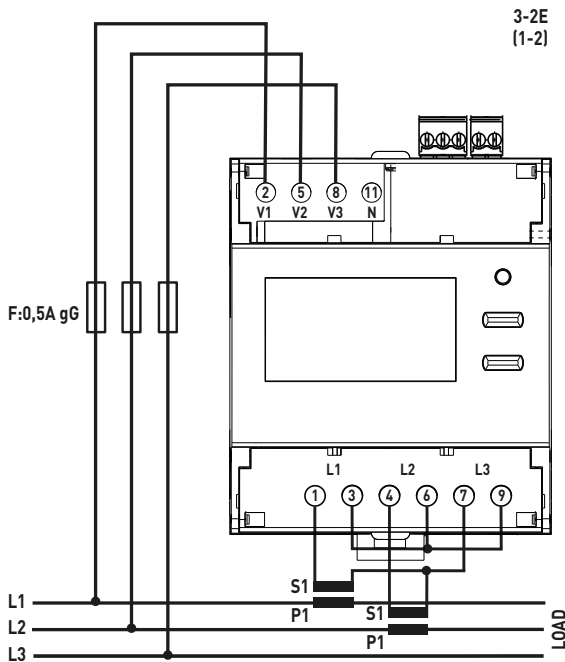

5. VERBINDUNGEN - ANSCHLUSS

Anschluss an VT:

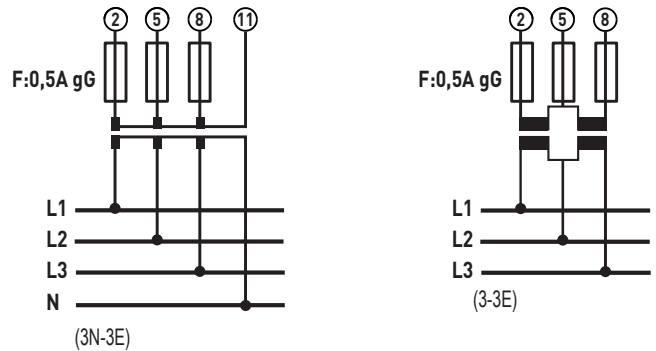

6. BETRIEBSDATEN (Fortsetzung)

6.1 STROMDATEN

Strom:

- Minimaler Messstrom: 0,05-5(6)A / 0,01-1(1,2)A
- Startstrom I_{st} : 10mA

Tensioni nominali:

- Dreiphasenspannung U_n :
3x100...3x400V, 3x100/173...3x230/400V $\sim \pm 15\%$

Nennfrequenz:

- F_n : 50Hz; 60Hz
- Zulässige Abweichung: 49...51Hz; 59...61Hz

Anschließbarer Abschnitt:

- Kupferleiter
- Spannungsanschlussklemmen (V1, V2, V3, N)
- Strömeanschlussklemmen (L1, L2, L3)

	Ohne Hülse	Mit Hülse
Steifes Kabel	1 x 0,75 + 16 mm ²	-
Flexibles Kabel	1 x 0,75 + 16 mm ² (∅ 5mm)	1 x 4 + 10 mm ²

- Klemmleisten oben am Zähler (Eingang, Impulsausgang und Bus):

	Ohne Hülse	Mit Hülse
Steifes Kabel	1 x 0,2 + 1,5 mm ²	-
Flexibles Kabel	1 x 0,2 + 1 mm ²	1 x 0,2 + 1 mm ²

Erforderliche Werkzeuge:

- Für alle Messklemmen: 6mm Flachsraubendreher oder Pozidriv Nr. 2
- Für Klemmleisten oben am Zähler (Eingang, Impulsausgang und Bus): Flachsraubendreher 2,5mm

Energiezähler bis CT/1A - /5A, Indirektanschluss

Codes: CE4TBDTCL1 – CE4TB0PCL1 – CE4TBMTCCL1
Modell: CONTO D4-Pt

6.2 MECHANIK

Schraubklemmen:

- Klemmentiefe: 12mm
- Abisolierlängen des Kabels: 11mm

Schraubenkopf:

- Spannungsanschlussklemmen (V1, V2, V3, N) und Ströme (L1, L2, L3): Schrauben mit gemischtem Schlitzkopf und Pozidriv Nr. 2
- Klemmleisten oben am Zähler (Eingang, Impulsausgang und Bus): Schlitzschrauben

Empfohlenes Anzugsmoment:

- Spannungsanschlussklemmen (V1,V2,V3,N): von 1,6Nm bis 2Nm
- Strömeanschlussklemmen (L1, L2, L3): von 1,6Nm bis 2Nm
- Klemmleisten oben am Zähler (Eingang, Impulsausgang und Bus): 0,2 N/m

Klemmschutz:

- Die Leistungsklemmen sind mit verschiebbaren und verschließbaren Klemmenabdeckungen geschützt, die im Gerät integriert sind.

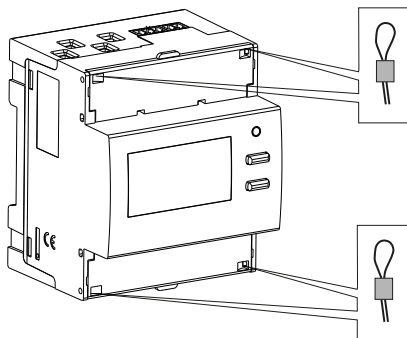

7. ALLGEMEINE EIGENSCHAFTEN (Fortsetzung)

Kennzeichnungsdaten:

Unlösbbare Markierung

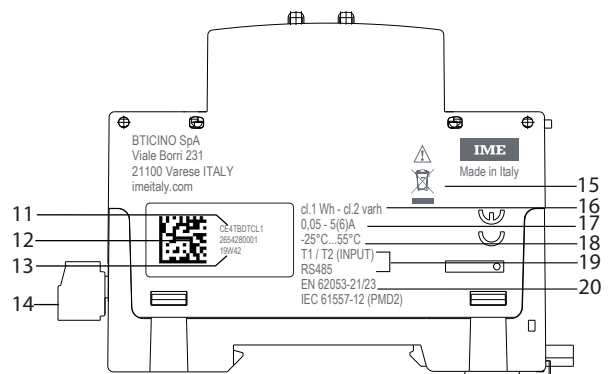
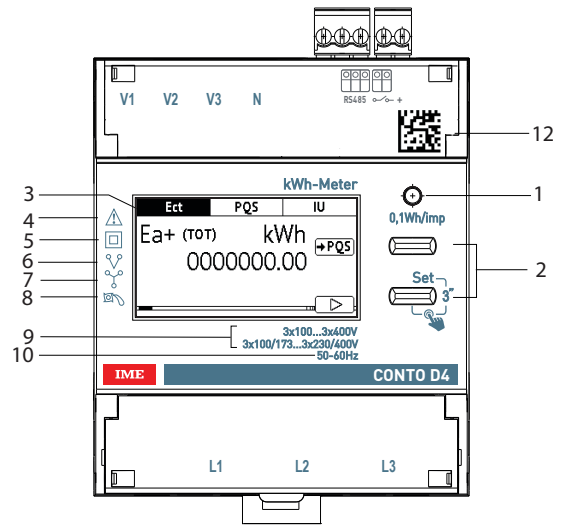

1. Metrologie LED
2. Tastatur bestehend aus 2 Tasten mit Doppelfunktion (Display/Konfiguration)
3. Graphisches Display
4. Bitte lesen das Handbuch bevor den Einbau
5. Doppelisolierung
6. Drehstromleitung 3 Leiter
7. Drehstromleitung 4 Leiter
8. Verdrehsicherung (Anti-Verringerung)
9. Spannung
10. Frequenz
11. Produktcode
12. Datamatrix für die Verfolgbarkeit des Produkts
13. Woche und Herstellungsjahr
14. Ausgang-Anschlussklemmen
15. Symbol für Elektronikschrott
16. Genauigkeitsklasse
17. Strom
18. Betriebstemperatur
19. Ausgänge
20. Norm

Energiezähler bis CT/1A - /5A, Indirektanschluss

Codes: CE4TBDTCL1 – CE4TB0PCL1 – CE4TBMTCL1
Modell: CONTO D4-PT

7. ALLGEMEINE EIGENSCHAFTEN

Lasermarkierung

Linken Seite

Informationen zur Rückverfolgbarkeit

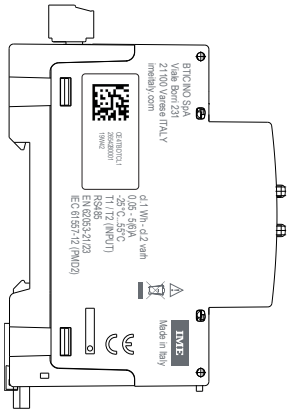

Rechte Seite

Anschlussschema

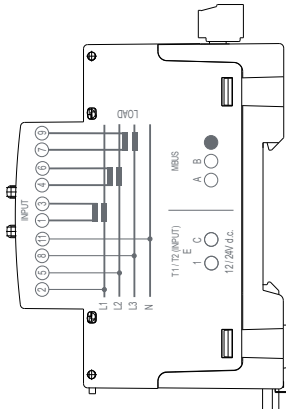
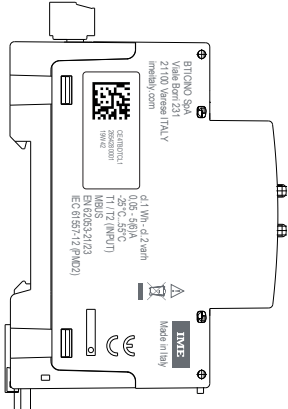
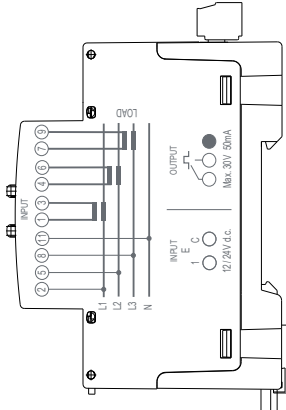
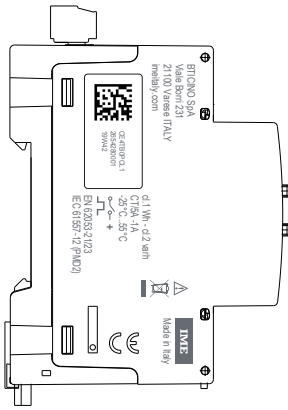
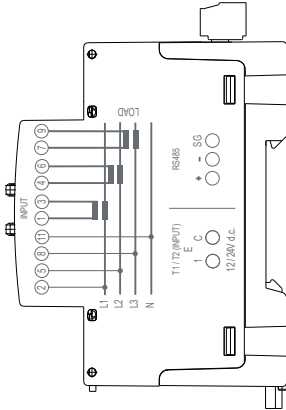

7. ALLGEMEINE EIGENSCHAFTEN (Fortsetzung)

Display:

- Rückbeleuchtete Anzeige 1,8 Zoll (256x128).

Auflösung:

- Gesamtzähler : 0,01kWh/kvarh
- Teilzähler: 0,01kWh/kvarh
- Tarifzähler: 0,01kWh/kvarh
- Verhältnis CT: 1...9999
- Verhältnis VT: 1,0...300,00

Maximale Anzeige

- Gesamtzähler : 9 999 999,99
- Teilzähler: 9 999 999,99
- Tarifzähler: 9 999 999,99

Metrologie LED: 0,1Wh/imp.

Anzeige des Wertes und Programmierung:

- Mit der Fronttastatur, 2 Tasten.
- Durch Identifikationscode (**Defaultcode 1000**) geschützte Änderungsmöglichkeit; der Code kann während des Programmiervorgangs geändert werden.

Messgrößen und Genauigkeit in:

Konform zu EN/IEC 62053-21

- Wirkenergie: Kl.1

Konform zu EN/IEC 62053-23

- Blindenergie Kl. 2

Konform zu EN/IEC 61557-12

- Strom: Kl. 0,5

- Spannung: Kl. 0,5

- Frequenz: $\pm 0,1$ Hz

- Momentane Gesamtwirkleistung, Phase, Mittelwert und maximaler Mittelwert: Kl.1

- Momentane Gesamtblindleistung, Phase: Kl.2

- Momentane Gesamtscheinleistung, Phase : Kl.1

- Leistungsfaktor Kl.1

Leistungsmittelwert:

- Größe: Wirkleistung

- Berechnung: Gleitender Durchschnitt, über den ausgewählten Zeitraum

- Mittlere Zeit: 5/8/10/15/20/30/60 Min.

Stundenzähler:

- Betriebsstunden und -Minutenzähler (**rückstellbarer Zähler**)

- Auflösung: 7 Zahlen (5 für Stunden + 2 für Minuten)

- Maximale Anzeige: 99 999,59 (Tarife insgesamt)

- Programmierbarer Wert: 0...50% Pn (positive)

Energiezähler bis CT/1A - /5A, Indirektanschluss

Codes: CE4TBDTCL1 – CE4TB0PCL1 – CE4TBMTCCL1
Modell: CONTO D4-Pt

7. ALLGEMEINE EIGENSCHAFTEN

Digitaleingang

- Der Digitaleingang ermöglicht die Umschaltung der Energiezählung auf 2 Tarife
- 2 Eingangsklemmen mit gemeinsamem Punkt (1 - C)
- Nennleistung: 12 – 24V d.c. Max. 10mA

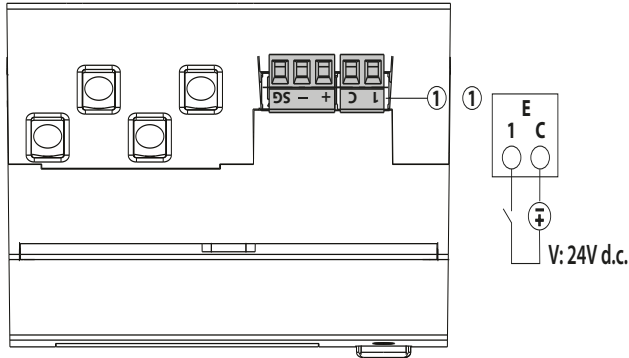

Eigenschaften des ModBus-Kommunikationsanschlusses:

- Programmierbare Adressen: von 1 bis 255 (5*)
- Kommunikationsgeschwindigkeit: 4,8 – 9,6 – 19,2* – 38,4 kbps
- Anzahl bit: 8
- Paritätsbit: kein, gerade*, ungerade
- Stoppbit: 1
- Galvanisch getrennt von Messeingängen
- Standard RS485 3-Draht, half-duplex
- Modbus® RTU Protokoll
- Die Antwortzeit (Time Out Frage/Antwort) \leq 200ms
- 120 Ω Abschlusswiderstand intern im Gerät (einstellbar über das SETUP-Menü, Default none*)

Eigenschaften des MBus-Kommunikationsanschlusses:

- Standard: EN 13757
- Übertragung: asynchron seriell
- Anzahl bit: 8
- Paritätsbit: kein, gerade fix
- Kommunikationsgeschwindigkeit: 300-600-1.200-2.400*-4.800-9.600bit/s
- Nr. Primäradresse: 0*...250
- Nr. Sekundäradresse: 0...99.999.999
- Load MBus:1
- Galvanisch getrennt von Messeingängen
- Übertragene Maße: siehe Kommunikationsprotokoll

Eigenschaften des Impulsausgangs:

- Optorelais mit SPST-NO Kontakt potentialfrei
- Typ S0 (IEC/EN62053-31)
- Spannung U_{imp} : Max. 24V a.c./d.c.
- Strom I_{imp} : Max. 50 mA
- Programmierbares Impulsgewicht, mögliche Werte:
1 – 10* – 100 – 1k – 10k Wh/imp oder varh/imp
- Programmierbare Impulsdauer, mögliche Werte:
50 -100* – 200 – 300 – 400 – 500ms

* Werkseitige Konfiguration

7. ALLGEMEINE EIGENSCHAFTEN

Hilfsspannung:

- Stromversorgung aus der Steckdose (Selbstversorgung)

Betriebstemperatur:

- Min. = - 25 °C Max. = + 55 °C

Lagertemperatur:

- Min. = - 25 °C Max. = + 70 °C
- Max. Luftfeuchtigkeit 85% nicht kondensierend

Kurzzeitige Überlast :

- 20 I_{max} per 0,5sec

Kurzschlussstrom:

- Der Test gilt nicht für indirekte Zähler.

Selbstverbrauch Spannungskreis:

- Max.1,5VA dreiphasig

Selbstverbrauch Stromkreis:

- Max.1,8W pro Phase

Maximale Verlustleistung für die thermische Dimensionierung der Schaltschränke: \leq 6W

Schutzklasse:

- Schutzart der Klemmen gegen Festkörper und Flüssigkeiten:
IP 20 (IEC/EN 60529).
- Schutzart des Gehäuses gegen Festkörper und Flüssigkeiten:
IP 54 (IEC/EN 60529).

Geräteschutz:

- Über einen magnetothermischen Schalter und Sicherung 0,5A gG

Umgebung: mechanisch M1 - elektrisch E2

Gehäusematerial: Polycarbonat

Volumen, verpackt: 0,60 dm³.

Gewicht: 0,210Kg

8. KONFORMITÄT UND ZERTIFIZIERUNGEN

Isolation

- Messkategorie: III
- Verschmutzungsgrad: 2
- Isolationsspannung, U_i : 300V, Phase-Nullleiter

Durchschlagfestigkeit:

- Speisung / Ausgänge: 4kV / 50Hz / 1min
- Gehäuse/Klemmen: 4kV / 50Hz / 1min

Impuls:

- Speisung: 6,3kV / 1,2 – 50µsec / 0,5J
- Speisung / Ausgänge: 6,3kV / 1,2- 50µs / 0,5J

Konform nach Normen:

- Genauigkeitsklasse: Wirkenergie: Klasse 1 (EN/IEC 62053-21)
- Genauigkeitsklasse: Blindenergie Klasse 2 (EN/IEC 62053-23)
- Elektromagnetische Verträglichkeit: Prüfungen gemäß EN/IEC 62052-11
- Genauigkeitsklasse gemäß EN61557-12

Umweltschutz - Konform nach den EWG-Richtlinien:

- Einhaltung der Richtlinie 2011/65 / EU in der durch die Richtlinie 2015/863 (RoHS 2) geänderten Fassung hinsichtlich der Beschränkungen der Verwendung einiger gefährlicher Stoffe in Elektro- und Elektronikgeräten
- Konform mit der REACH-Verordnung (1907/2006): Zum Zeitpunkt der Veröffentlichung dieses Dokuments ist kein in Anhang XIV enthaltener Stoff in diesen Produkten enthalten.
- WEEE-Richtlinie (2012/19 / EU): Die Vermarktung dieses Produkts liefert einen Beitrag an die Umweltorganisationen in jedem europäischen Land, die für die Entsorgung der Altgeräte verantwortlich sind, die in den Geltungsbereich der europäischen Richtlinie über Elektro- und Elektronik-Altgeräte fallen.

Kunststoffe:

- Halogenfreie Kunststoffe.
- Kennzeichnung von Teilen nach ISO 11469 und ISO 1043.

Verpackungen:

- Gestaltung und Herstellung von Verpackungen gemäß Dekret 98-638 vom 20.07.98 und Richtlinie 94/62/EG

9. KOMMUNIKATION

Anschlussbilder RS485 Modbus:

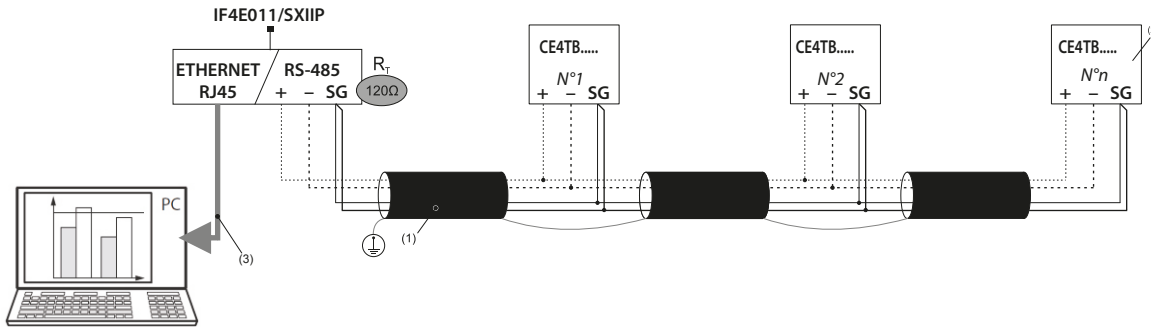

Anschlussplan RS485 Modbus Mini Web Server:

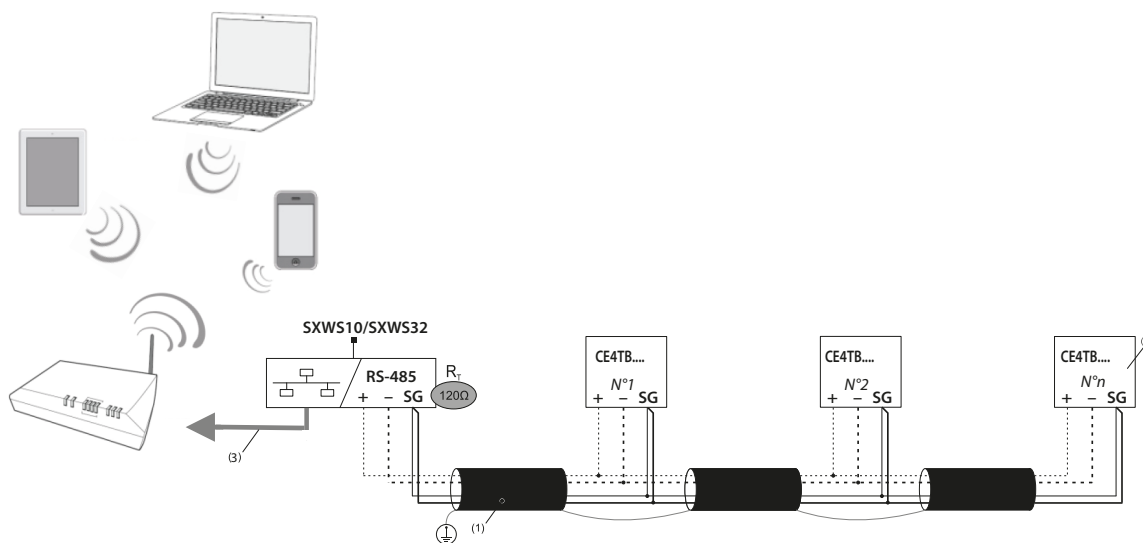

- (1) RS485: Vorgeschriebene Verwendung von Kabeln vom Typ Belden 9842, Belden 3106A (oder gleichwertig) für eine maximale Buslänge von 1000 m oder Kabel der Kategorie 6 (FTP oder UTP) für eine maximale Länge von 50 m.
- (2) 120Ω Abschlusswiderstand intern im Gerät (einstellbar über das SETUP-Menü)
- (3) Ethernet: Kat. 6 (FTP/UTP)

Anschlussbilder Mbus:

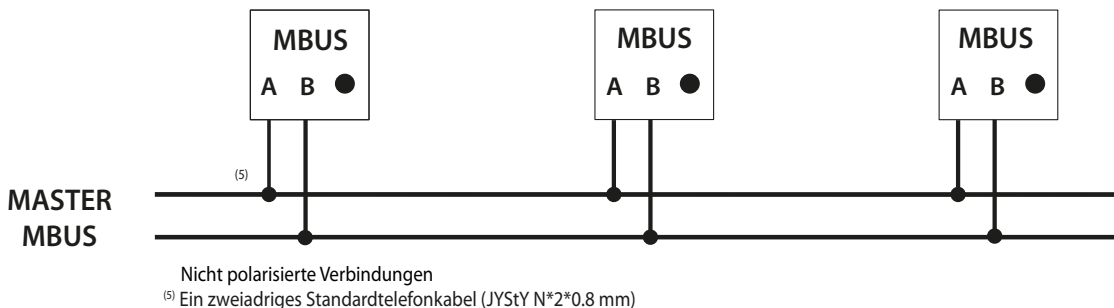

Kommunikationstabelle

- Die MODBUS- und MBUS-Kommunikationsprotokoll sind auf der Website <http://www.imeitaly.com>

Contador de energía en CT/1A - /5A, de inserción indirecta

Códigos: CE4TBDTCL1 – CE4TB0PCL1 – CE4TBMTCCL1
 Modelo: CONTO D4-Pt



Índice	Páginas
1. Uso	1
2. Gama	1
3. Instalación	1
4. Dimensiones	1
5. Conexiones	2
6. Datos de funcionamiento	3
7. Características generales	4
8. Conformidad y certificaciones	7
9. Comunicación	8

1. USO

Contador bidireccional de energía activa y reactiva (4 cuadrantes). Conexión indirecta mediante transformadores de corriente con relación /1A - /5A. El dispositivo, en 4 módulos DIN, se autoalimenta y cuenta con comunicación ModBus o Mbus o salida de pulsos y doble entrada de tarifa.

El menú permite elegir configurar el dispositivo para el funcionamiento en los varios tipos de conexión (3N3E;3-3E;3-2E).

2. GAMA

Código del Art.	In	Saldas	Entradas	Rango de voltaje
CE4TB0PCL1	1/5A	Impulsos	Impulsos	3x100V 3x230V 3x400V ± 15%
CE4TBDTCL1	1/5A	ModBus	2 Tarifa / Impulsos	3x100V 3x230V 3x400V ± 15%
CE4TBMTCCL1	1/5A	Mbus	2 Tarifa / Impulsos	3x100V 3x230V 3x400V ± 15%

3. INSTALACIÓN

Fijación:

En carril simétrico EN/IEC 60715 o guía DIN 35

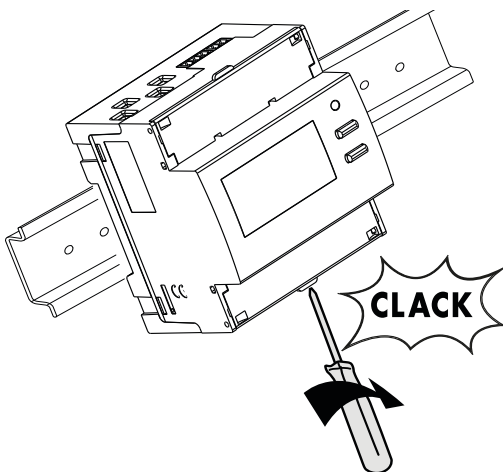

Herramientas necesarias:

Para la fijación del equipo en la guía DIN: destornillador plano de 5,5 mm (de 4 a 6 mm).

Posición de funcionamiento:

Vertical, horizontal, arriba y abajo, lateral

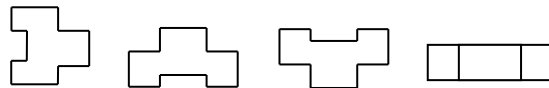

4. DIMENSIONS

Funda: 4 módulos DIN43880

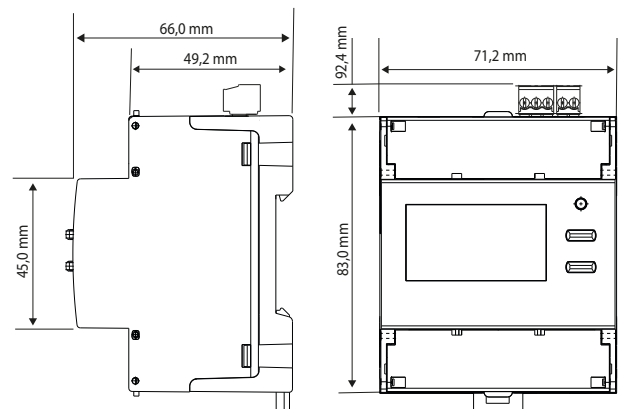

Contador de energía en CT/1A - /5A, de inserción indirecta

Códigos: CE4TBDTCL1 – CE4TB0PCL1 – CE4TBMTC11

Modelo: CONTO D4-Pt

5. CONEXIONES - CONEXION

Marcado de regletas y combinación de esquemas:

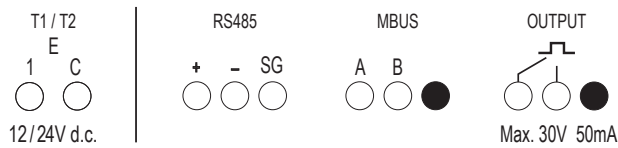

Esquemas de inserción:

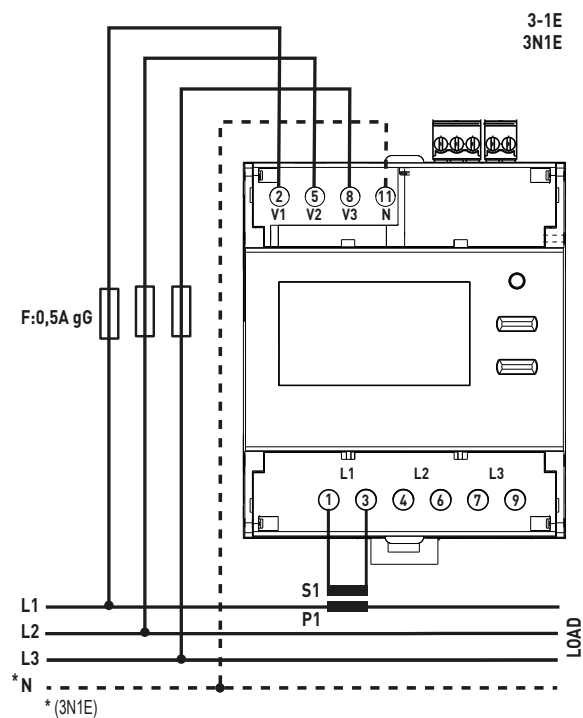
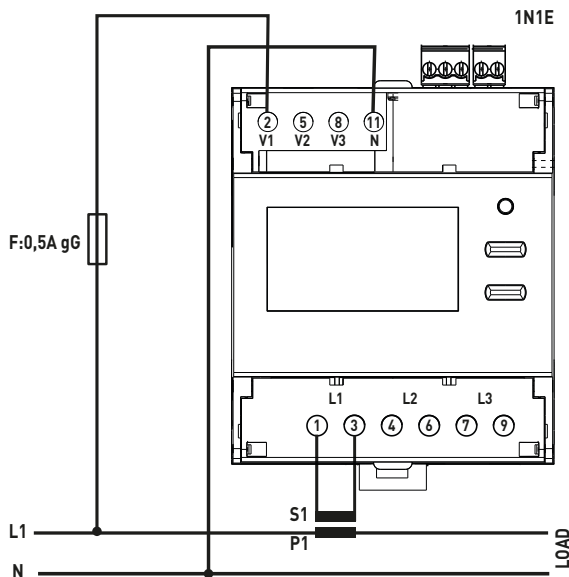

5. CONEXIONES - CONEXION (sigue)

Esquemas de inserción:

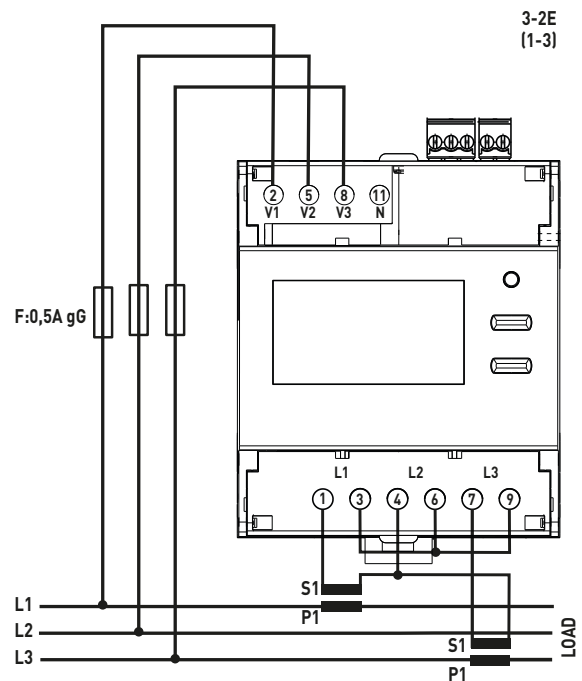
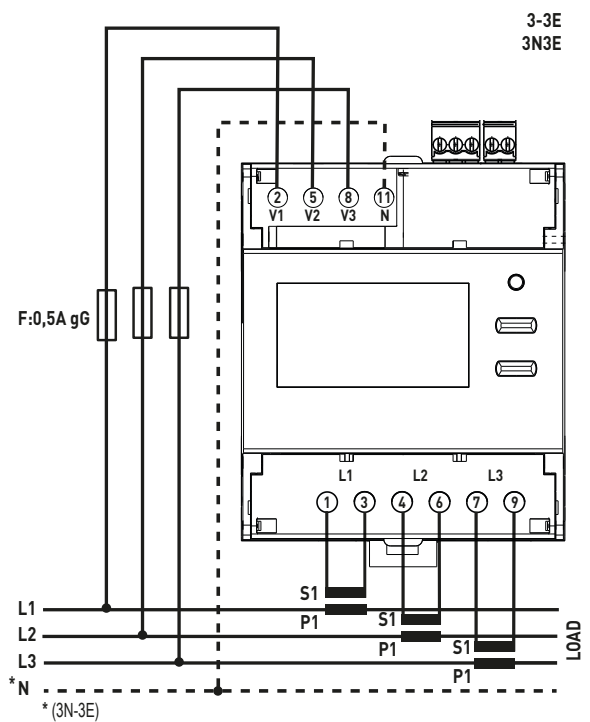

Contador de energía en CT/1A - /5A, de inserción indirecta

Códigos: CE4TBDTCL1 – CE4TB0PCL1 – CE4TBMTCL1
Modelo: CONTO D4-Pt

5. CONEXIONES - CONEXION

Esquemas de inserción:

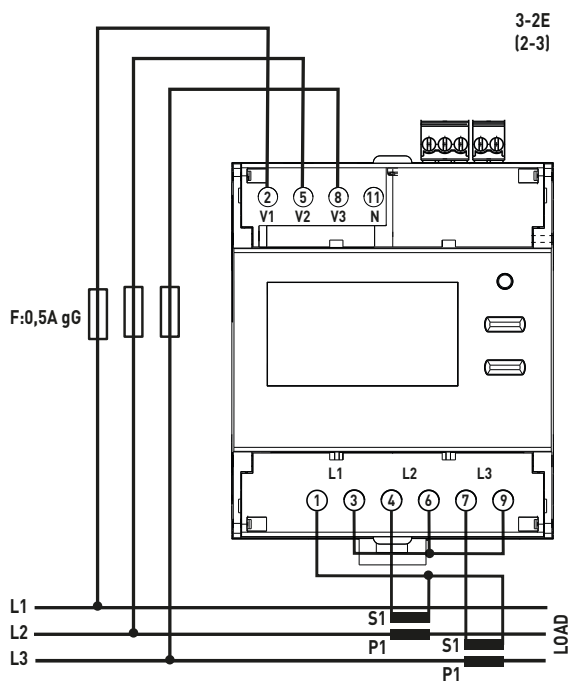
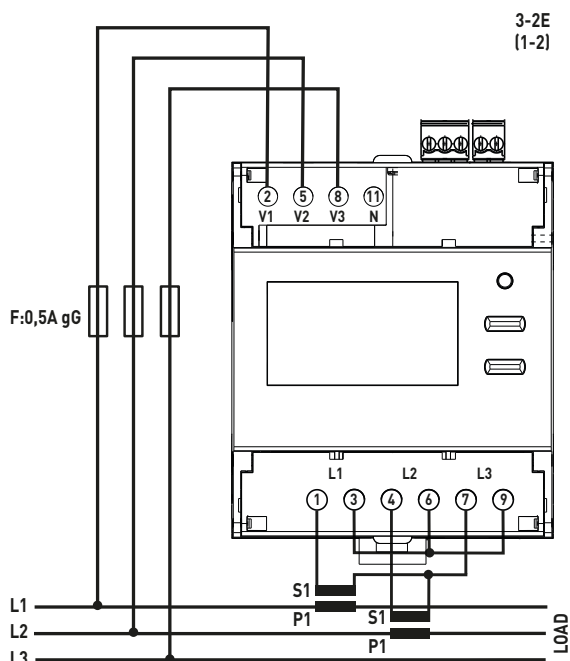

5. CONEXIONES - CONEXION

Inserción en VT:

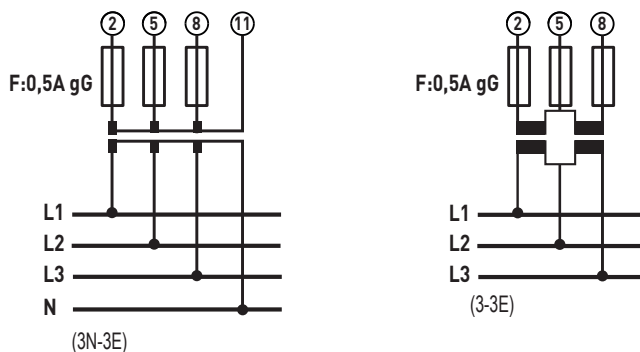

6. DATOS DE FUNCIONAMIENTO (sigue)

6.1 ELÉCTRICOS

Corrientes:

- Corriente mínima de medición: 0,05-5(6)A / 0,01-1(1,2)A
- Corriente de arranque: I_{st} : 10mA

Tensiones nominales:

- Tensión trifásica U_n : 3x100...3x400V, 3x100/173...3x230/400V ~ ±15%

Frecuencia nominal:

- F_n : 50Hz; 60Hz
- Variación admitida: 49...51Hz; 59...61Hz

Sección conectable:

- Cables de cobre.
- Bornes de conexión de las tensiones (V1, V2, V3, N)
- Bornes de conexión de las corrientes (L1, L2, L3)

	Sin brújula	Con brújula
Cable rígido	1 x 0,75 + 16 mm²	-
Cable flexible	1 x 0,75 + 16 mm² (Ø 5mm)	1 x 4 + 10 mm²

- Regletas en la parte superior del contador (entrada, salida impulsos y bus):

	Sin brújula	Con brújula
Cable rígido	1 x 0,2 + 1,5 mm²	-
Cable flexible	1 x 0,2 + 1 mm²	1 x 0,2 + 1 mm²

Herramientas necesarias:

- Para todos los bornes de conexión de la medida: destornillador plano de 6mm o Pozidriv n.º2
- Para las regletas en la parte superior del contador (entrada, salida impulsos y bus) destornillador plano de 2,5 mm

Contador de energía en CT/1A - /5A, de inserción indirecta

Códigos: CE4TBDTCL1 – CE4TB0PCL1 – CE4TBMTC1

Modelo: CONTO D4-PI

6.2 MECÁNICOS

Bornes de rosca:

- Profundidad de los bornes: 12mm
- Longitudes de la peladura del cable: 11mm

Cabeza del tornillo:

- Bornes de conexión de las tensiones (V1, V2, V3, N) y de las corrientes (L1, L2, L3): tornillos con cabeza mixta de ranura y Pozidriv n.º2
- Regletas en la parte superior del contador (entrada, salida impulsos y bus): tornillos con cabeza de ranura

Par de apriete recomendado:

- Bornes de conexión de las tensiones (V1,V2,V3,N): de 1,6Nm a 2Nm
- Bornes de conexión de las corrientes (L1, L2, L3): de 1,6Nm a 2Nm
- Regletas en la parte superior del contador (entrada, salida impulsos y bus): 0,2N/m

Protección de los bornes:

- Los terminales de potencia están protegidos con placas cubre bornes deslizantes y sellables, integradas en el dispositivo

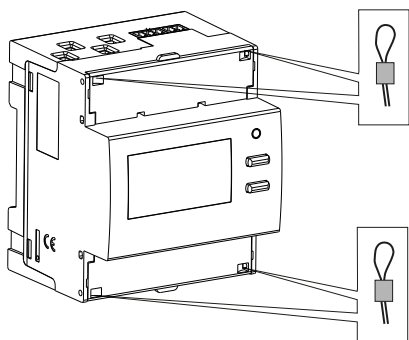

7. CARACTERÍSTICAS GENERALES (sigue)

Datos de marcado:

Marcado indeleble

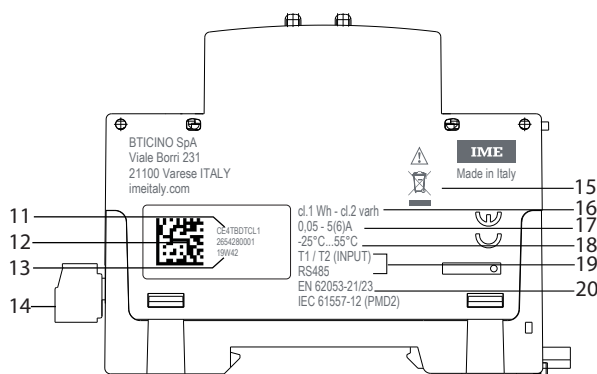
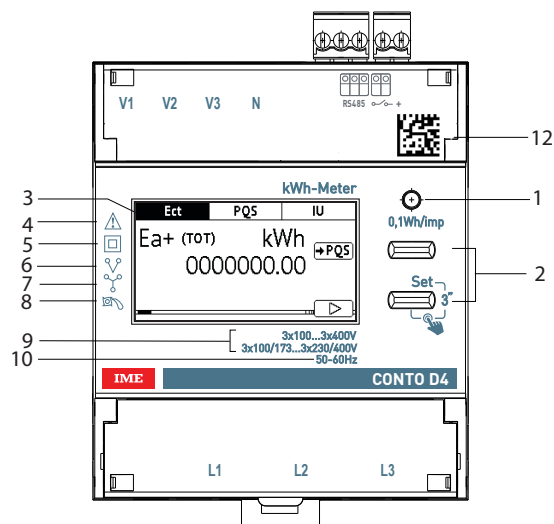

1. LED metrológico
2. Teclado compuesto por 2 botones con doble función (visualización/configuración)
3. Display gráfico
4. Consultar el manual de uso antes de la instalación
5. Aislamiento doble
6. Inserción en línea trifásica de 3 hilos
7. Inserción en línea trifásica de 4 hilos
8. Dispositivo antirotación (antidecremento)
9. Tensión
10. Frecuencia
11. Código del artículo
12. Datamatrix para trazabilidad del producto
13. Semana y año de fabricación
14. Bornes de conexión salidas
15. Símbolo RAEE
16. Clase de precisión
17. Corriente
18. Temperatura de uso
19. Salidas
20. Normativa

Contador de energía en CT/1A - /5A, de inserción indirecta

Códigos: CE4TBDTCL1 – CE4TB0PCL1 – CE4TBMTCL1
Modelo: CONTO D4-Pt

7. CARACTERÍSTICAS GENERALES

Tratamiento al láser

Lado izquierdo

Información sobre el seguimiento

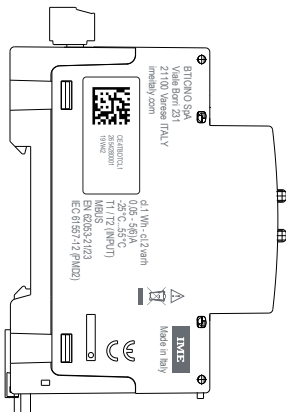
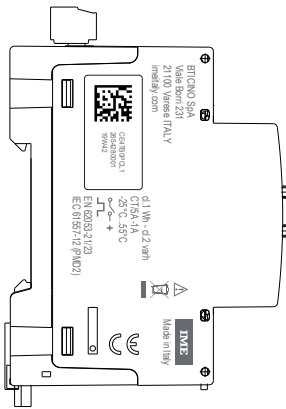
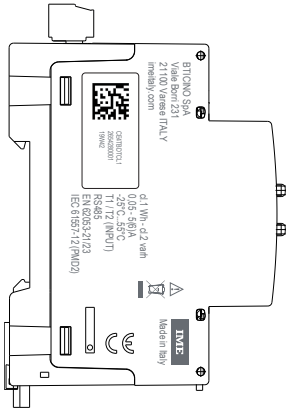

Lado derecho

Esquema de conexión

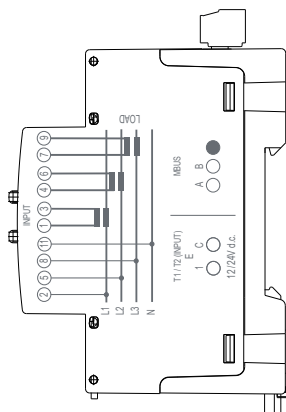
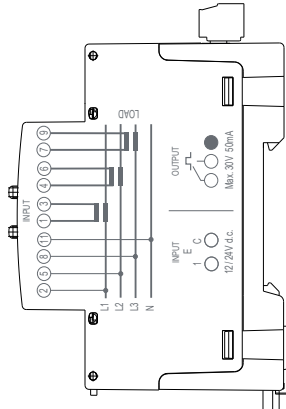
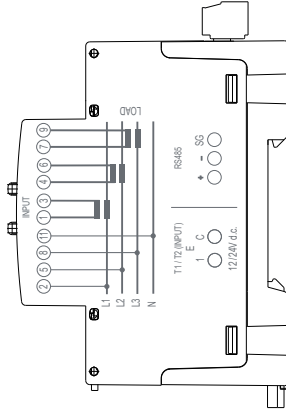

7. CARACTERÍSTICAS GENERALES (sigue)

Pantalla:

- Gráfico retroiluminado 1,8 pulgadas (256x128).

Resolución:

- Contadores totales: 0,01kWh/kvarh
- Contadores parciales : 0,01kWh/kvarh
- Contadores tarifas: : 0,01kWh/kvarh
- Relación de CT: 1...9999
- Relación de VT: 1,00...300,00

Indicación máxima:

- Contadores totales: 9 999 999,99
- Contadores parciales 9 999 999,99
- Contadores tarifas: 9 999 999,99

LED metroológico: 0,1Wh/imp.

Visualización del valor y programación:

- Mediante el teclado frontal, 2 botones.
- Modificación protegida por el código de identificación (**código predefinido 1000**); el código puede modificarse durante el procedimiento de programación.

Magnitudes medidas y precisión en:

Conformidad a EN/IEC 62053-21

- Energía activa clase 1

Conformidad a EN/IEC 62053-23

- Energía reactiva clase 2

Conformidad a EN/IEC 61557-12

- Corriente: cl.0,5
- Tensión: cl.0,5
- Frecuencia: ± 0,1 Hz
- Potencia total activa instantánea, fase, valor medio y máx. valor medio: cl.1
- Potencia total reactiva instantánea, fase: cl.2
- Potencia total aparente instantánea, fase: cl.1
- Factor de potencia: cl.1

Potencia media:

- Magnitud: potencia activa
- Cálculo: media móvil, en el periodo seleccionado
- Tiempo media: 5/8/10/15/20/30/60min.

Cuentahoras:

- Recuento de horas y minutos de funcionamiento (**cuentahoras con puesta a cero**)
- Resolución: 7 cifras (5 para las horas + 2 para los minutos)
- Visualización máxima: 99 999,99 (total tarifas)
- Valor programable: 0...50% Pn (positiva)

Contador de energía en CT/1A - /5A, de inserción indirecta

Códigos: CE4TBDTCL1 – CE4TB0PCL1 – CE4BTMTCL1
Modelo: CONTO D4-Pt

7. CARACTERÍSTICAS GENERALES

Entrada digital

- La entrada digital permite la conmutación del recuento de energía en 2 tarifas
- 2 bornes de entrada con punto en común (1 - C)
- Tensión nominal: 12 – 24V d.c. máx. 10mA

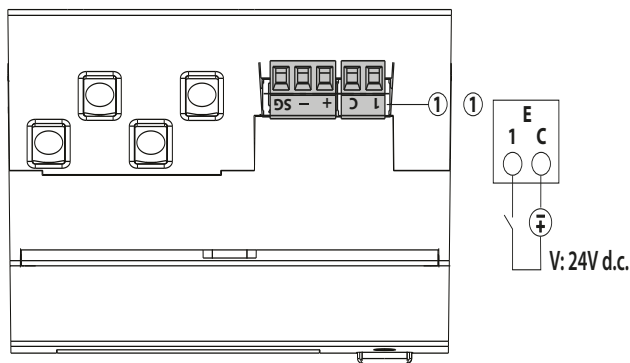

Características del puerto de comunicación ModBus:

- Direcciones programables: 1 a 255 (5*)
- Velocidad de comunicación: 4,8 – 9,6 – 19,2* – 38,4 kbps
- N°-bit: 8
- Bits de paridad: ninguno, pares*, impares
- Bits de stop: 1
- Aislamiento galvánico respecto de las entradas de medida
- Estándar RS485 3 hilos, half-duplex
- Protocolo Modbus® RTU
- Tiempo de respuesta (time-out pregunta/respuesta): ≤ 200ms
- Resistencia de terminación de 120Ω interna en el instrumento (ajustable en el menú de SETUP, valor predefinido none*)

Características del puerto de comunicación MBus:

- Estándar: EN 13757
- Transmisión: asíncrona serial
- N°-bit: 8
- Bits de paridad: pares fija
- Velocidad de comunicación: 300-600-1.200-2.400*-4.800-9.600bit/s
- N.º dirección primaria: 0*...250
- N.º dirección secundaria: 0...99.999.999
- Load MBus: 1
- Aislamiento galvánico respecto de las entradas de medida
- Medidas transferidas: ver el protocolo de comunicación

Características de la salida impulsos:

- Opto-relé con contacto SPST-NO libre de potencial
- Tipo S0 (IEC/EN62053-31)
- Tensión Uimp: Máx. 24V a.c./d.c.
- Corriente Iimp: Máx. 50 mA
- Peso del impulso programable, valores posibles: 1 – 10* – 100 – 1k – 10k Wh/imp o varh/imp
- Duración del impulso programable, valores posibles: 50 -100* – 200 – 300 – 400 – 500ms

* Configuración de fábrica

7. CARACTERÍSTICAS GENERALES

Alimentación auxiliar:

- Derivada de la toma de presión (autoalimentado)

Temperatura ambiente de funcionamiento:

- Min. = - 25 °C Max. = + 55 °C

Temperatura ambiente de almacenaje:

- Min. = - 25 °C Max. = + 70 °C
- Humedad máxima 85% sin condensación

Sobrecorriente de breve duración::

- 20 I_{max} durante 0,5sec.

Corriente de cortocircuito:

- Prueba no aplicable a los contadores indirectos.

Autoconsumo circuito de tensión:

- Máx. 1,5 VA trifásica

Autoconsumo circuito de corriente:

- Máx. 1,8 W por fase

Potencia térmica máxima disipada por el dimensionamiento térmico de los cuadros: ≤ 6W

Clase de protección:

- Grado de protección de los bornes contra cuerpos sólidos y líquidos: IP 20 (IEC/EN 60529).
- Grado de protección de la envoltura contra cuerpos sólidos y líquidos: IP 54 (IEC/EN 60529).

Protección del equipo:

- Mediante interruptor magnetotérmico y fusible de 0,5A gG

Entorno: mecánico M1 – eléctrico E2

Material de la funda: Policarbonato

Volumen embalado: 0,60 dm³

Peso: 0,210Kg

8. CONFORMIDAD Y CERTIFICACIONES

Aislamiento

- Categorías de medida: III
- Grado de contaminación: 2
- Tensión de aislamiento, Ui: 300V, Fase-Neutro

Rigidez dieléctrica:

- Alimentaciones / Salidas: 4kV / 50Hz / 1min
- Envoltura / Terminales: 4kV / 50Hz / 1min

Impulso:

- Alimentaciones: 6,3kV / 1,2 – 50µsec / 0,5J
- Alimentaciones / Salidas: 6,3kV / 1,2- 50µs / 0,5J

Conformidad a las normas:

- Clase de precisión: Energía activa clase 1 (EN/IEC 62053-21)
- Clase de precisión: Energía reactiva clase 2 (EN/IEC 62053-23)
- Compatibilidad electromagnética: Pruebas en conformidad a la EN/IEC 62052-11
- Clase de precisión en conformidad a la IEC/EN61557-12

Respeto del medio ambiente - Conformidad a las directivas CEE:

- Conformidad a la directiva 2011/65/UE, modificada por la directiva 2015/863 (RoHS 2), relativa a las limitaciones sobre la utilización de algunas sustancias peligrosas en los aparatos eléctricos y electrónicos.
- Conformidad al Reglamento REACH (1907/2006): en la fecha de publicación de este documento, ninguna sustancia insertada en el anexo XIV se encuentra presente en el interior de estos productos.
- Directiva RAEE (2012/19/EU): la comercialización de este producto contempla una aportación a los eco-organismos encargados, en cada país europeo, de la gestión del fin de vida de los productos pertenecientes al campo de aplicación de la directiva europea sobre los residuos de aparatos eléctricos y electrónicos.

Materias plásticas:

- Materias plásticas sin halógenos.
- Marcado de las partes según las normas ISO 11469 e ISO 1043.

Embalajes:

- Diseño y producción de los embalajes en cumplimiento del Decreto 98-638 del 07.20.98 y de la directiva 94/62/CE

9. COMUNICACIÓN

Esquema de conexión RS485 Modbus:

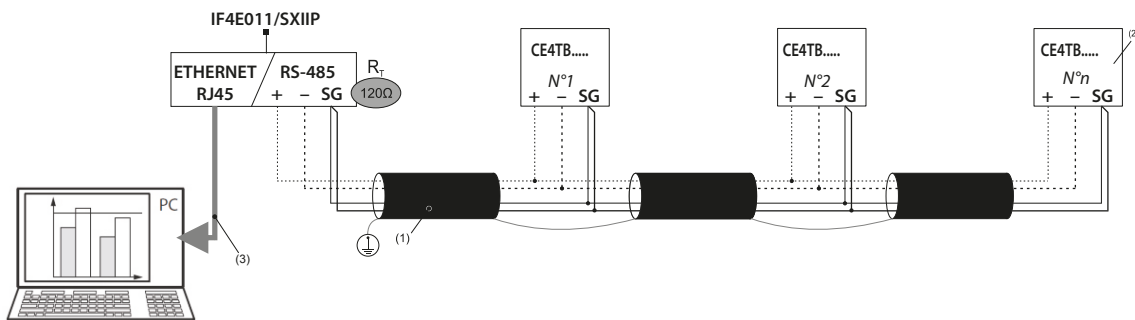

Esquema de conexión RS485 Modbus con Mini Web Server:

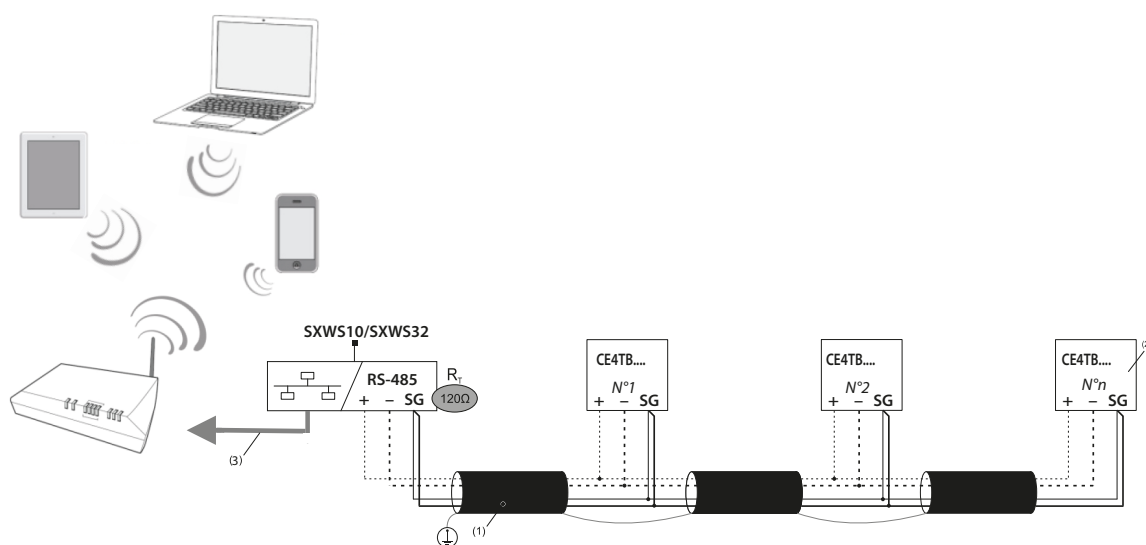

(1) RS485: Uso prescrito de un cable de tipo Belden 9842, Belden 3106A (u otro equivalente) para una longitud máxima del bus de 1000 m, o de un cable de Categoría 6 (FTP o UTP) para una longitud máxima de 50 m

(2) Resistencia de terminación de 120Ω interna en el instrumento (ajustable en el menú SETUP)

(3) Ethernet: Cat. 6 (FTP/UTP)

Esquema de conexión Mbus:

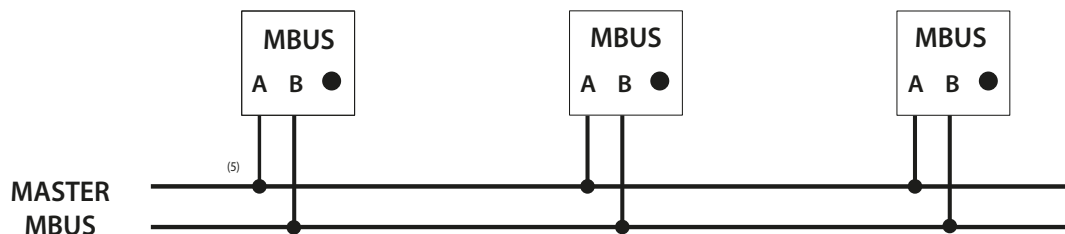

Conexiones no polarizadas

(5) Un cable telefónico estándar de dos hilos (JYStY N*2*0.8 mm)

Tablas de comunicación

- Los protocolos de comunicación MODBUS y MBUS están disponibles en el sitio <http://www.imeitaly.com>