

Nemo SX – Multifunction Measuring module with closed Rogowski coils

Cat. Nos: **SX3M63, SXMM63, SXMT63, SXMT125, ROGEXTM1, ROGEXTM3**

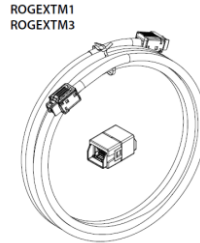
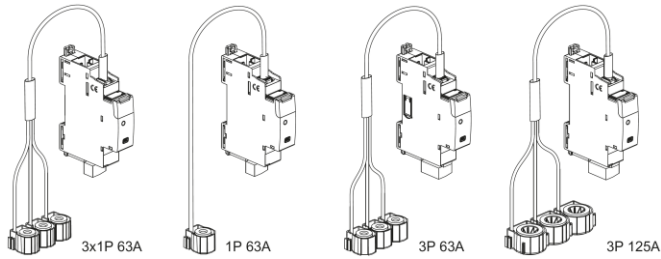

Contents	Pages
1. Description - Use	1
2. Range	1
3. Overall dimensions	2
4. Preparation - Connection	3
5. General characteristics	7
6. System architectures	12
6.1 Stand-alone	12
6.1.1 with local addressing	12
6.1.2 with remote addressing	13
6.2 Supervised	14
6.2.1 with local addressing	14
6.2.2 with remote addressing	16
7. Compliance and approvals	18

1. DESCRIPTION - USE

. Module dedicated to Nemo SX System.
 Multifunction Measuring module.
 Measures the main electrical data of a single-phase or three-phase network.
 The insertion is done by closed Rogowski coils.

2. RANGE

- . Cat. n° SX3M63: Multifunction measuring module (1 module. 17,8 mm width) delivered with non-interchangeable coil to measure three single-phase circuits up to 63 A at once
- . Cat. n° SXMM63: Multifunction measuring module (1 module. 17,8 mm width) delivered with non-interchangeable coil to measure a single-phase circuit up to 63 A
- . Cat. n° SXMT63: Multifunction measuring module (1 module. 17,8 mm width) delivered with non-interchangeable coils to measure a three-phase circuit up to 63 A
- . Cat. n° SXMT125: Multifunction measuring module (1 module. 17,8 mm width) delivered with non-interchangeable coils to measure a three-phase circuit up to 125 A

2. RANGE (continued)

Rated current:

- . Cat. nos SX3M63, SXMM63, SXMT63:
 Min current, I_{min}: 1 A
 Base current, I_b: 20 A
 Max current, I_{max}: 63 A
- . Cat. No SXMT125:
 Min current, I_{min}: 2 A
 Base current, I_b: 40 A
 Max current, I_{max}: 125 A

Insertion rated voltages:

- . Un: 110÷500 V~ (phase/phase)
- . Un: 65÷290 V~ (phase/neutral)

Rated frequency:

- . fn: 50/60 Hz
- . Admitted variation:
 45 ÷ 55 Hz (fn 50 Hz)
 55 ÷ 65 Hz (fn 65 Hz)

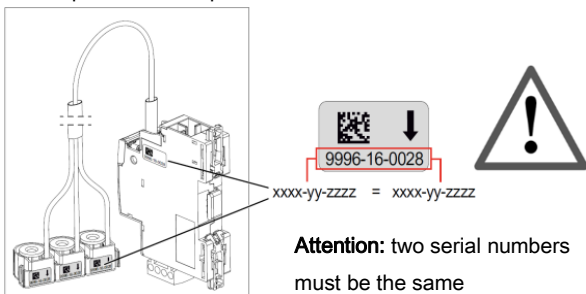

Attention: two serial numbers must be the same

- . Cat. n° ROGEXTM1: kit consisting of n°1 Rogowski coils extension cable of 1000 mm length + n°1 Extension connector.
 - . Cat. n° ROGEXTM3: kit consisting of n°1 Rogowski coils extension cable of 3000 mm length + n°1 Extension connector.
- Allow to increase the length of Rogowski coils cable: cords are clipped to either side of the connector.

Maximum total allowed length: 3,35 meters (Rogowski coils cable: 0,35 m; Extension cable: 3 m).

Nemo SX - Multifunction Measuring module with closed Rogowski coils

Cat. Nos: SX3M63, SXMM63, SXMT63, SXMT125, ROGEXTM1, ROGEXTM3

3. OVERALL DIMENSIONS

SX3M63:
Module

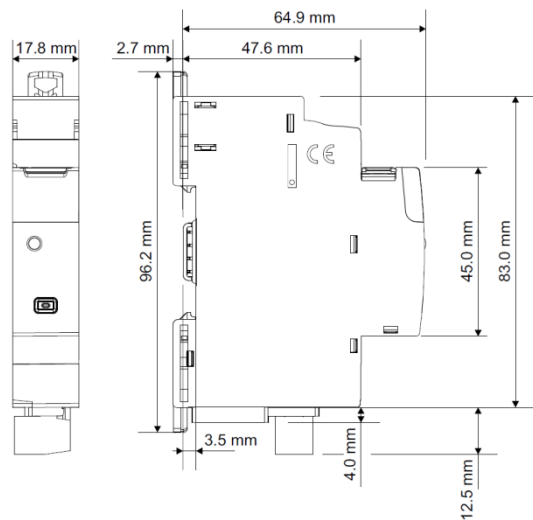

Rogowski coil

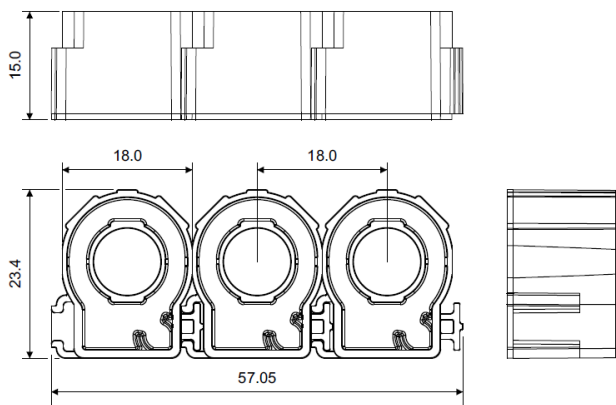

SXMM63:
Module

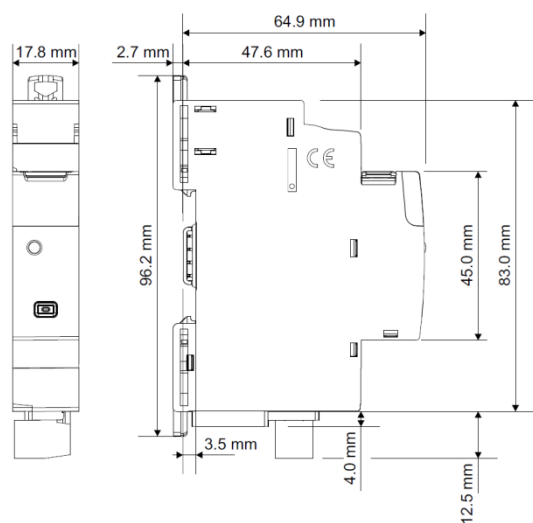

3. OVERALL DIMENSIONS (continued)

SXMM63 (continued):
Rogowski coil

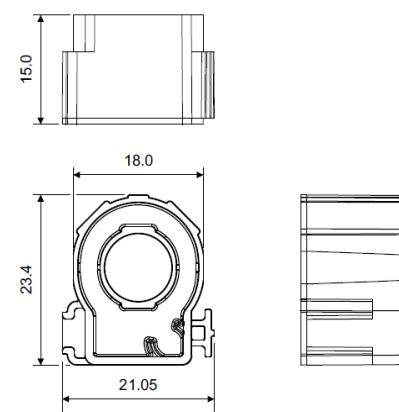

SXMT63:
Module

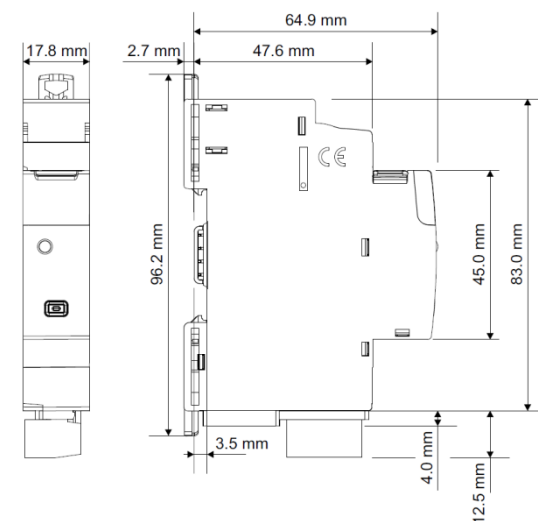

Rogowski coil

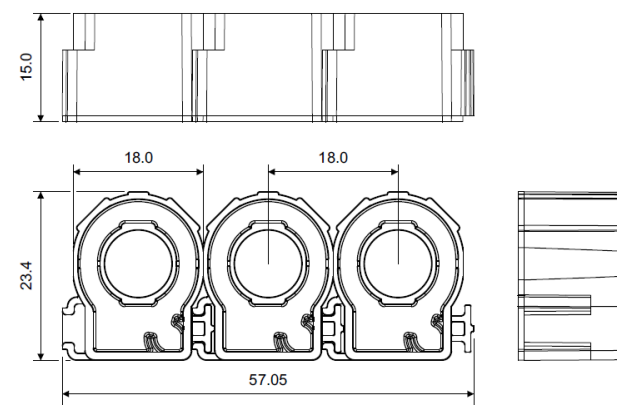

Note:

- Pitch between two sensors is 18.0 mm
- Sensors can be simply separated in order to be associated to modular devices 1,5 modules per pole width or to non-modular power devices (e.g. MCCB's)

Nemo SX - Multifunction Measuring module with closed Rogowski coils

Cat. Nos: SX3M63, SXMM63, SXMT63, SXMT125, ROGEXTM1, ROGEXTM3

3. OVERALL DIMENSIONS (continued)

SXMT125:
Module

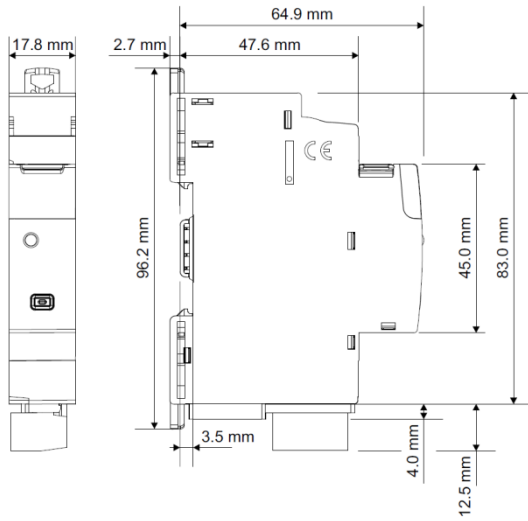

Rogowski coil

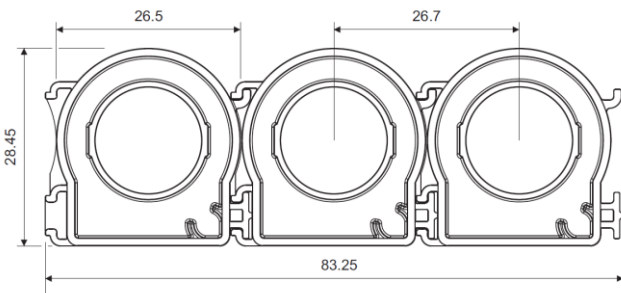

Note:

- . Pitch between two sensors is 26.7 mm
- . Sensors can be simply separated in order to be associated to non-modular power devices (e.g. MCCB's)

. Rogowski sensor(s) - Cable length

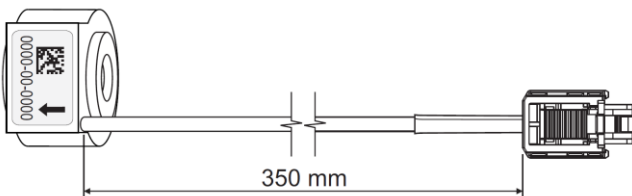

This length can be stretched via the Extension cable + connector up to 3,35 meters (0,35 m of Rogowski cable and up to 3 m of extension)

4. PREPARATION -CONNECTION

Fixing:

- . On symmetric rail EN/IEC 60715 or DIN 35 rail

Operating positions:

- . Vertical, Horizontal, Upside down, On the side

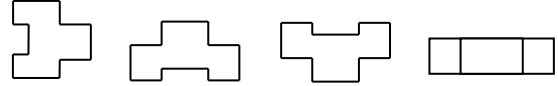

Power Supply:

- . Mandatory in 12 VDC via the specific Power supply module Cat n°SXAA230
- . Two ways:
 - via specific communication patch cords (cat. nos SXAC250/500/1000) to connect at the downstream through on dedicated ports

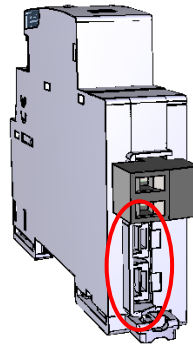

- via specific communication rails (cat. nos SXAR18/24/36) to connect at the rear through dedicated connectors

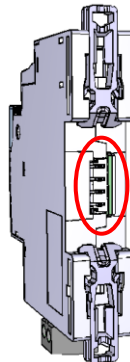

Voltage terminals:

- The removable black terminal is used to connect voltage(s)
- . Terminal depth: 8 mm.
- . Stripping length: 8 mm

Screw head:

- . Screw slotted.

Recommended tightening torque:

- . 0,5 Nm.

Recommended tools:

- . For the terminals: flat screwdriver 3,5 mm.
- . For fixing: flat screwdriver 5.5 mm (6 mm maximum).

Nemo SX - Multifunction Measuring module with closed Rogowski coils

Cat. Nos: SX3M63, SXMM63, SXMT63, SXMT125, ROGEXTM1, ROGEXTM3

4. PREPARATION –CONNECTION (continued)

Connectable section:

. Copper cables.

Voltage measurement terminals

	Without ferrule	With ferrule
Rigid Cable	1 x 0,5 mm ² to 2,5 mm ² 2 x 1,5 mm ²	-
Flexible Cable	1 x 0,5 mm ² to 2,5 mm ² 2 x 1,5 mm ²	1 x 0,5 mm ² to 2,5 mm ² 2 x 1,5 mm ²

. 63 A Current Rogowski coil(s) (SX3M63, SXMM63, SXMT63)

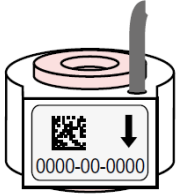
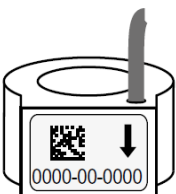
	With internal plastic support	Without internal plastic support
		
Rigid Cable	1 x 1,5 mm ² to 16 mm ² ø 4,8 mm	1 x 1,5 mm ² to 25 mm ² ø 9,3 mm
Flexible Cable	1 x 1,5 mm ² to 10 mm ² ø 4,8 mm	1 x 1,5 mm ² to 16 mm ² ø 9,3 mm

. 125 A Current Rogowski coil(s) (SXMT125)

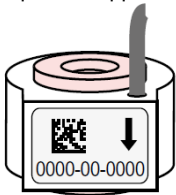
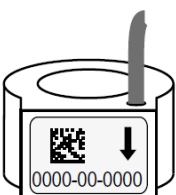
	With internal plastic support	Without internal plastic support
		
Rigid Cable	1 x 25 mm ² to 70 mm ² ø 6,4 - 12,4 mm	1 x max. 70 mm ² ø 15,3 mm
Flexible Cable	1 x 16 mm ² to 50 mm ² ø 6,4 - 12,4 mm	1 x max. 50 mm ² ø 15,3 mm

4. PREPARATION –CONNECTION (continued)

Wiring diagrams:

Note:

. Rogowski coils can be positioned both upstream or downstream the associated protection device of the measured line.

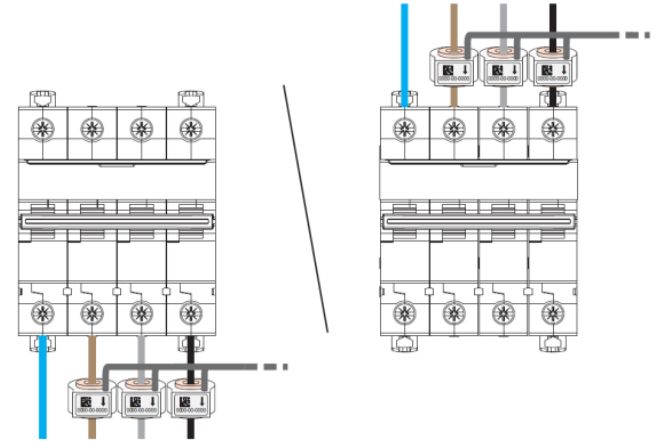

. Rogowski coils must be put in the correct direction of current flow (**arrow drawing on the coil**).

However, the direction of current flow can be, if necessary, changed via Nemo SX Configuration software or via Mini configuration module (cat. no SXV01).

. SX3M63

single phase network (3 x 1N-1E):

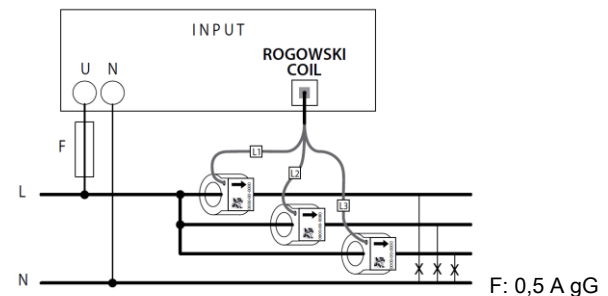

Note: the 3 single-phase circuits measured must come from the same phase.

. SXMM63

single phase network (1N-1E):

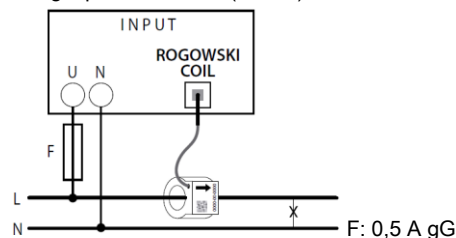

Nemo SX - Multifunction Measuring module with closed Rogowski coils

Cat. Nos: SX3M63, SXMM63, SXMT63, SXMT125, ROGEXTM1, ROGEXTM3

4. PREPARATION –CONNECTION (continued)

Wiring diagrams (continued):

. SXMT63, SXMT125

3 wires three-phase network, 3 sensors (3-3E):

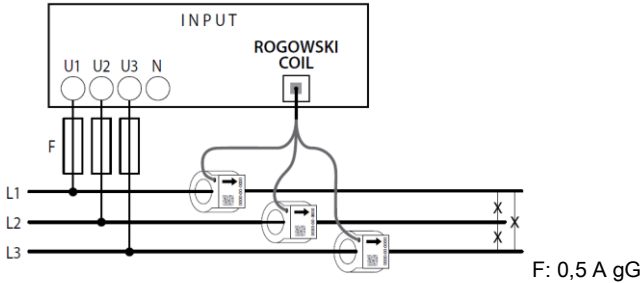

4 wires three-phase network, 3 sensors (3N-3E):

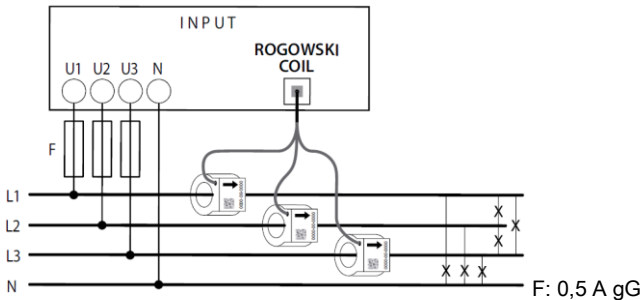

. Rogowski coil(s) cable length (see § Overall Dimensions) allow you to put Nemo SX Measure modules everywhere in the installation. This is not mandatory to have them near to the associated protection device of the measured line.

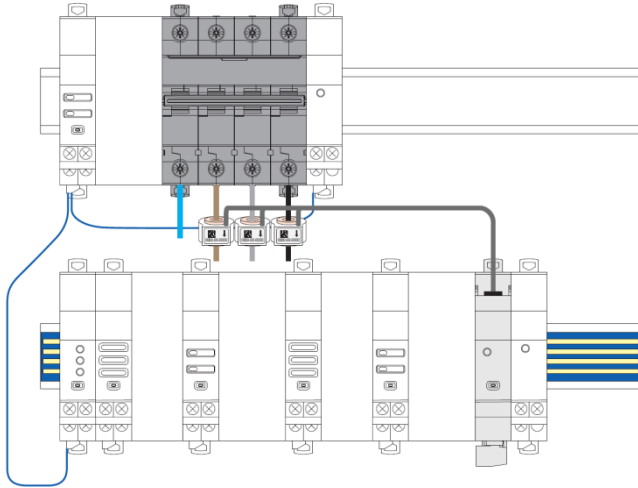

4. PREPARATION –CONNECTION (continued)

Use of Extension kit:

Cords are to be clipped to either side of the connector.

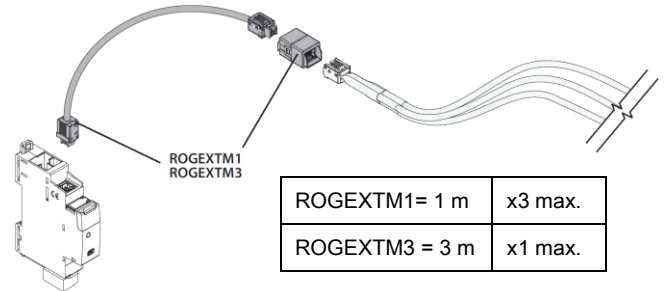

Module configuration:

. For these devices, following configurations are available:

- SX3M63, SXMM63:
 - current versus
- SXMT63, SXMT125:
 - current versus
 - insertion type (network with or without neutral conductor) [see § wiring diagrams]

Configurations are made by Nemo SX configuration software or by the Nemo SX mini configurator module (cat no SXV01)

Data connection (Nemo SX modules inter-connection):

. Via specific communication patch cords (cat. nos SXAC250/500/1000)



Allow data transmission between the different Nemo SX modules. This type of connection is recommended when there are few Nemo SX modules, distributed all over the enclosure.

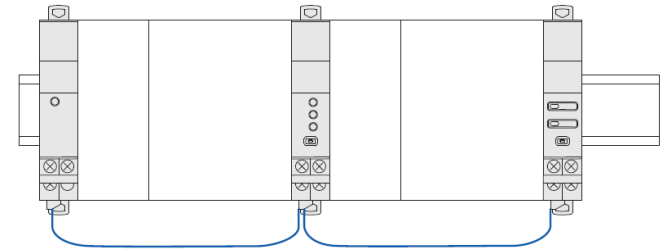

Implementing: with this configuration, the plastic protection cover of the backside communication ports on the Nemo SX module must be kept on.

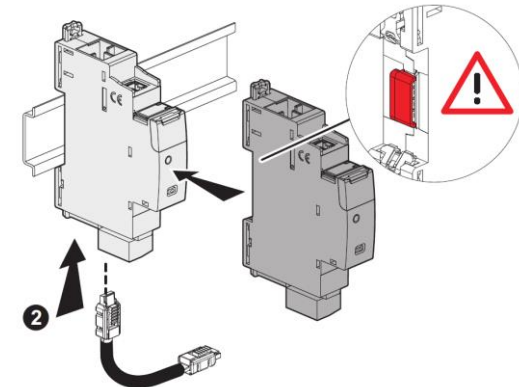

Nemo SX - Multifunction Measuring module with closed Rogowski coils

Cat. Nos: SX3M63, SXMM63, SXMT63, SXMT125, ROGEXTM1, ROGEXTM3

4. PREPARATION –CONNECTION (continued)

Data connection (Nemo SX modules inter-connection)

(continued):

- Via specific communication rails (cat. nos SXAR18/24/36).

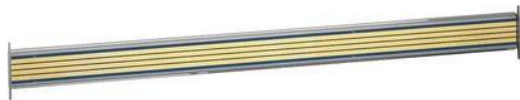

- Allow data transmission between the different Nemo SX modules. This type of connection is recommended when there are several Nemo SX modules on the same DIN row.

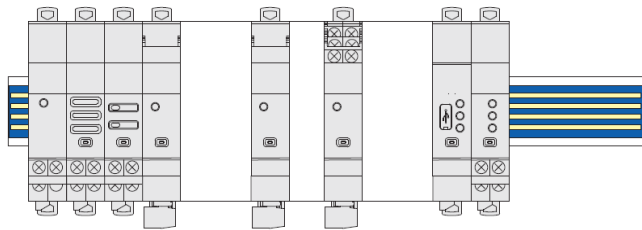

Implementing: with this configuration, the plastic protection cover of the backside communication ports on the Nemo SX module must be removed.

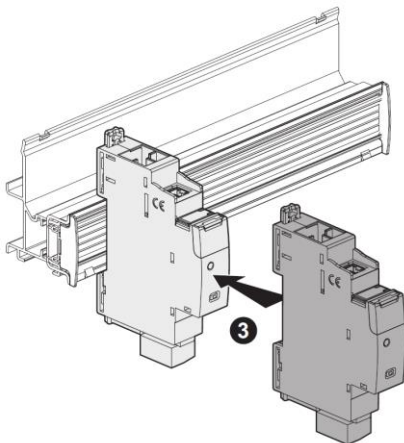
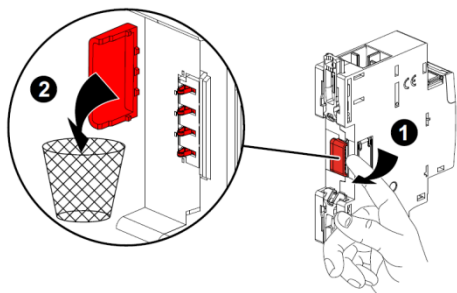

4. PREPARATION –CONNECTION (continued)

Data connection (Nemo SX modules inter-connection)

(continued):

- Via a mix between specific communication patch cords and communication rails in order to create a link between several rows

Two situations:

- Individually connected with communication rails. The communication patch cord allows to connect two rows.

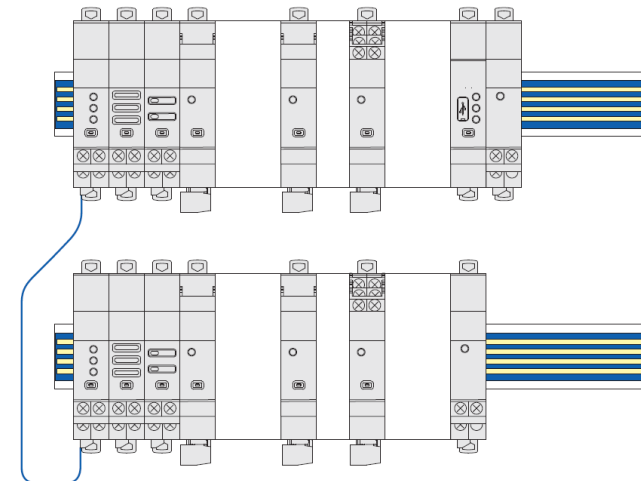

- Individually connected with communication patch cords & communication rail. The communication patch cords allow to connect Nemo SX modules on a row and to connect two rows.

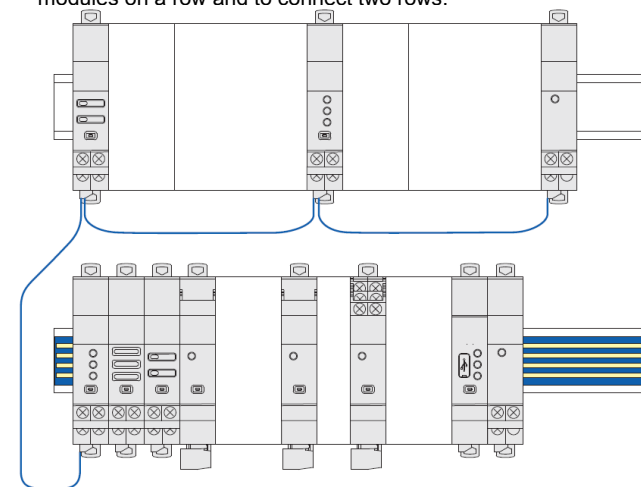

Nemo SX - Multifunction Measuring module with closed Rogowski coils

Cat. Nos: SX3M63, SXMM63, SXMT63, SXMT125, ROGEXTM1, ROGEXTM3

5. GENERAL CHARACTERISTICS

Front face marking:

. By permanent ink pad printing (red line) and laser marking



Lateral side marking:

. By laser.

left side: Standard and programming information

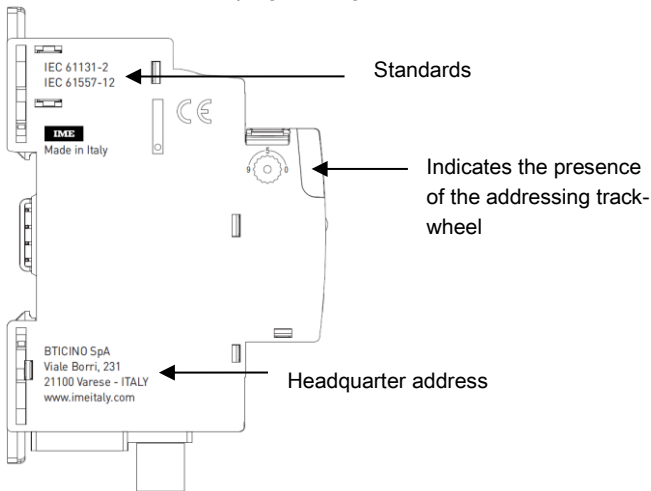

right side: cabling and traceability information

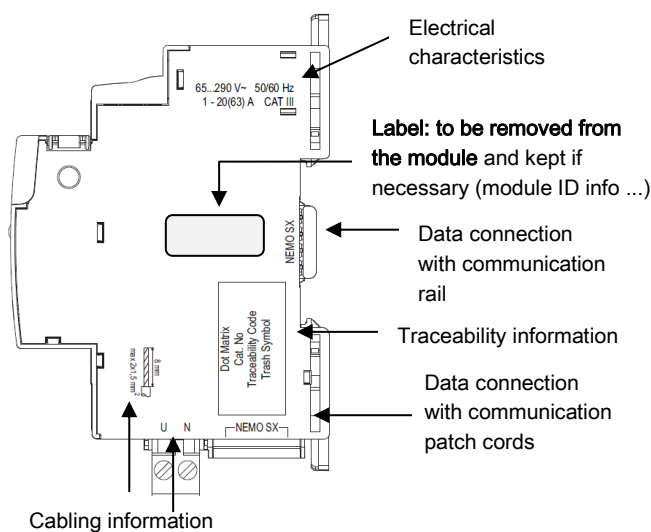

5. GENERAL CHARACTERISTICS (continued)

Voltage measurement terminal block marking:

. By permanent ink pad printing.

SX3M63, SXMM63 SXMT63, SXMT125

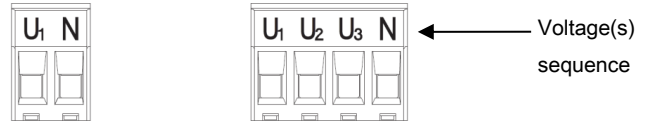

Measuring LED:

. The device is equipped with a measuring LED; it gives information that the device is counting an energy consumption:

- blinking red → 0,2 Wh per light pulse

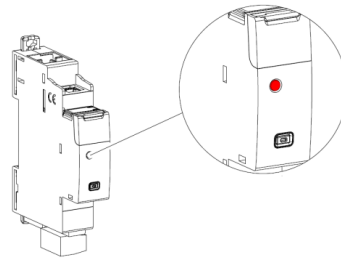

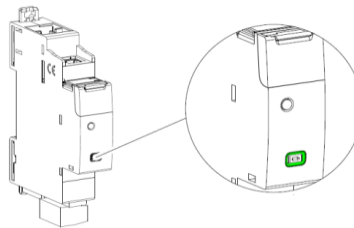

Multi-Functions button:

. Front face button as several functions:



. Give information about the operating state on the module

Possible states:

Colour	State	Meaning
 red	Slow blinking	Error (e.g. addressing error)
	Fast blinking	No function
	Steady <i>(pressing the multifunction button longer than 10 sec.)</i>	Total reset [any firmware updates are preserved]
 green	Slow blinking	System process is running. Wait until the Led turns steady
	Fast blinking <i>(pressing the multifunction button for 5 sec.)</i>	put in "Stand-by" the EMS BTDIN module (no remote action and communication available)
	Steady	System OK, connection is running
 orange	Slow blinking	Creation of a link with "Link Functionality" procedure (<i>see next §</i>)
	Fast blinking	Device's firmware update in progress
	Steady	No function

5. GENERAL CHARACTERISTICS *(continued)*

Link Functionality:

. This function allows you to link two Nemo SX modules to create automatic actions that, once programmed, can run independently without a connection to a manager is needed.

The basic rule is the link between an event (circuit breaker that trip, a threshold exceeded, etc.) and an action accordingly (signalling, opening of a circuit by motorized control or contactor, etc.).

Possible associations are:

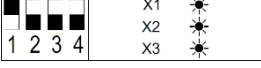
Event generator	Action module	
	Command: SXM0C1	State: SXMC02
Measure: SX3M63, SXMM63, SXMT63, SXMT125, SXMMT5, SXMR02, SXMR04, SXMR06, SXMR08	✓	✓ Only with the module configured (locally or remotely) as shown: 
State: SXMC02	✓	✗ It's enough to configure the module (locally or remotely) as "Slave"

Note:

- association can only be of type 1 to 1 (1 event and 1 action).
- modules already associated cannot be used for other associations.
- all the configuring procedure will be done with the Configuration Software (available online for free). *[For more details refer to the Installation Manual of Nemo SX Configuration software]*

5. GENERAL CHARACTERISTICS *(continued)*

Modules compatible with "Link Functionality" feature: firmware versions and production date:

Cat n°	Firmware version	Production date indicated on the label stucked on the side of the module
SX3M63	all firmware versions	any production date
SXMM63	ver. \geq 2.0.1	date \geq 18W49
SXMT63	ver. \geq 2.0.1	date \geq 18W49
SXMT125	all firmware versions	any production date
SXMMT5	ver. \geq 2.0.1	date \geq 18W35
SXMR02	all firmware versions	any production date
SXMR04	all firmware versions	any production date
SXMR06	all firmware versions	any production date
SXMR08	all firmware versions	any production date
SXMC02	ver. \geq 2.0.2	date \geq 18W49
SXM0C1	ver. \geq 3.0.2	date \geq 18W39
SXV01	ver. \geq 2.0.4	date \geq 18W38
SXI485	ver. \geq 3.0.8	date \geq 18W31

Measured quantities and Accuracy class:

. Current (accuracy 0,5):

phase: I_1, I_2, I_3 ;
neutral: I_N .

. Voltage (accuracy 0,5):

phase/phase: U_{12}, U_{23}, U_{31} ;
phase/neutral: V_{1N}, V_{2N}, V_{3N} .

. Frequency (accuracy 0,1)

. Power:

instantaneous active total power, phase (accuracy 0,5);
instantaneous reactive total power, phase (accuracy 1);
instantaneous apparent total power, phase (accuracy 0,5);

. Power factor a (accuracy 0,5).

. Energy:

total and partial active energy, positive and negative (accuracy 0,5);
total and partial reactive energy, positive and negative (accuracy 2).

. THD (accuracy 1):

voltages THD: V_1, V_2, V_3 o U_{12}, U_{23}, U_{31} ;
currents THD: I_1, I_2, I_3, I_N .

. Harmonic analysis:

Voltages: odd harmonics up to 15th (in display and via communication RS485);
Currents: odd harmonics up to 15th (in display and via communication RS485);

Note: measurement accuracy is guaranteed only with the conductor correctly centred in each measuring sensor (*see table of § "Connectable section" for proper use of the internal plastic support*).

Nemo SX - Multifunction Measuring module with closed Rogowski coils

Cat. Nos: SX3M63, SXMM63, SXMT63, SXMT125, ROGEXTM1, ROGEXTM3

5. GENERAL CHARACTERISTICS *(continued)*

Measuring sensors operating range:

- Max Rogowski primary current:
SX3M63, SXMM63, SXMT63 = 63 A
SXMT125 = 125 A

Insulation voltage (at voltage measurement terminals):

- U_i = 500 V (Ph-Ph)

Impulse withstand voltage U_{imp}:

- Nemo SX ports / Voltages input terminals:
wave 1,2 / 50 μs: 6 kV
alternate current 50 Hz / 1 min.: 3 kV
- Nemo SX ports / Current sensors input terminal:
wave 1,2 / 50 μs: 6 kV
alternate current 50 Hz / 1 min.: 3 kV

Pollution degree:

- 2 according to IEC/EN 60898-1.

Overvoltage category:

- III

Dielectric strength:

- 2500 V

Plastic material:

- Self-extinguishing polycarbonate.
- Heat and fire resistant according to IEC/EN 60695-2-12, glow-wire test at 960°C.
- Classification UL 94 / IECEN 60695-11-10: V1

Ambient operating temperature:

- Min. = -25°C. Max. = +70°C

Ambient storage temperature:

- Min. = -40°C. Max. = +70°C

Protection Index:

- Protection index of terminals against direct contacts: IP2X (IEC/EN 60529).
- Protection index of terminals against solid and liquid bodies (wired device): IP 20 (IEC/EN 60529).
- Protection index of the front face against solid and liquid bodies: IP 40 (IEC/EN 60529).
- Class II, front panel with faceplate.

Average weight per device:

- Weight inclusive of measuring sensors

	kg
ROGEXTM1	0,050
ROGEXTM3	0,130
SXMM63	0,104
SXMM63	0,068
SXMT63	0,104
SXMT125	0,150

5. GENERAL CHARACTERISTICS *(continued)*

Volume when packed:

	dm ³
ROGEXTM1	0,050
ROGEXTM3	0,130
SX3M63, SXMM63, SXMT63, SXMT125,	0,33

Consumption:

- Values at 12 VDC

	W	mA
SXMM63	0,419	34,8
SXMM63	0,410	34,1
SXMT63	0,419	34,8
SXMT125	0,419	34,8

5. GENERAL CHARACTERISTICS *(continued)*

Load shedding Function:

. Allows to automatically carry out load shedding in case of power demand when a circuit exceeds a threshold.

. Function is implementable using together following Nemo SX modules:

- Multifunction Control module (cat. no SXM0C1) with DIP-switches on 0000 position (see § "Module configuration")
- Measurement modules (cat. nos SX3M63, SXMM63, SXMT63, SXMT125, SXMMT5, SXMR02, SXMR04, SXMR06, SXMR08)

To set the different parameters it is necessary to use the Nemo SX Configuration software (available online for free)

. Procedure:

1. Assign the same address to the Nemo SX modules (Multifunction control and Measurement modules) which require to be linked
2. Connect a computer to the Modbus/Nemo SX interface or to the Mini configuration module (according to the system architecture type; see § "System architectures")
3. In the Nemo SX Configuration software pages adjust the parameters:

. In the dedicated page of the Measurement module:

- **Threshold:** value of Total active power (kW) above which procedure starts. *(default value 100 kW)*

- **Hysteresis:** value expressed in % of the threshold under which the alarm is over and the disconnected loads are restored. *(default value 5%, max value 100%)*

- **Alarm delay (s)** - *(default value 1 sec., max. value 30000 sec):*

during the activation of an alarm: is the waiting time between the threshold point and the alarm on the Nemo SX bus

during the de-activation of an alarm: is the waiting time between the hysteresis point and the alarm is deactivation on the Nemo SX bus

. In the dedicated page of the Universal control module:

- **Relay normal state:** the rest position of the relay; normally open (NO) or normally closed (NC).

- **Relay activation:** impulsive or maintained

- **Relay activation time (s):** used for the impulsive work method only; represents the time in which the relay remains in the working position.

(default value 1 sec., max. value 6000 sec):

- **Activation delay (s):** waiting time between the alarm on the Nemo SX bus and the action done by the universal control module *(default value 0 sec, max. value 6000 sec):*

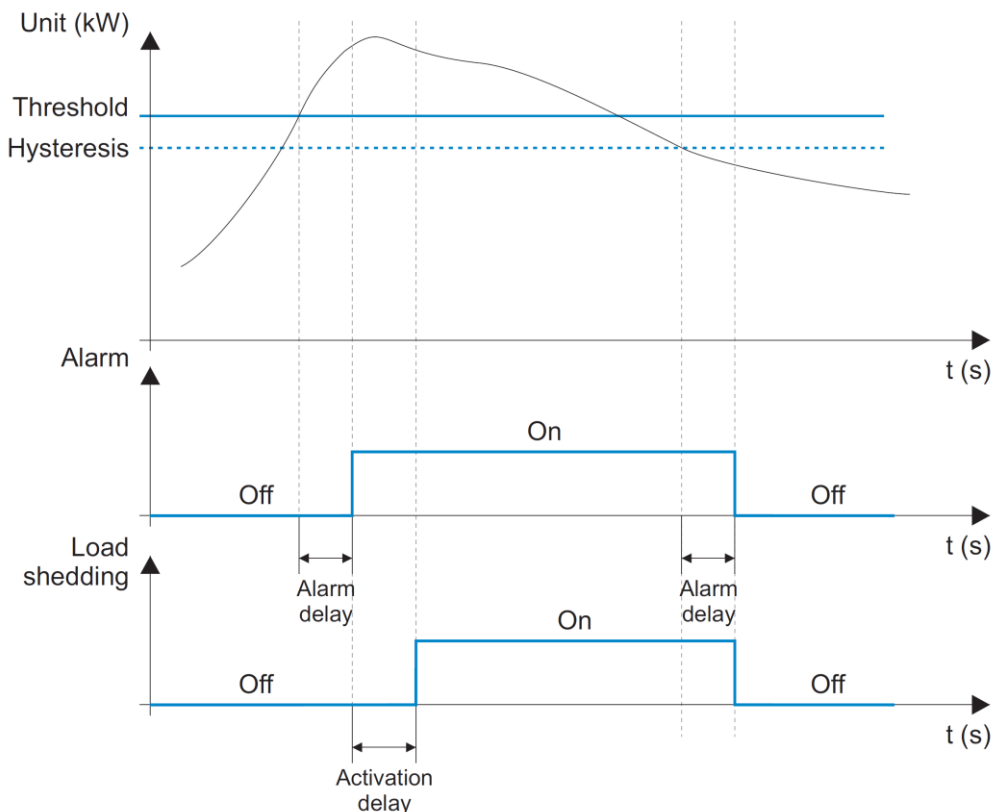

6. SYSTEM ARCHITECTURES

The Nemo SX is a polyvalent system and, according to the needs of the customer, can be set up and/or used as “Stand-alone” or “Supervised” system. Based on this choice the configuration and addressing methods are different.

Four possible architectures are provided:

6.1 Stand-alone system

6.1.1 with local addressing (through the track wheel)

6.1.2 with remote addressing (through a computer)

6.2 Supervised (Computer Supervisory System)

6.2.1 with local addressing

6.2.2 with remote addressing

6.1 Stand-alone system

. **Stand-alone** = autonomous system. To be used by the end-user if it is not necessary to have a computer for the supervision outside the envelope. Everything can be managed on site.

6.1.1 Stand-alone system with local addressing (through the track wheel)

Local addressing advantages:

- No configuration software needed to set-up the installation
- **It is not necessary to use a computer to manage settings** (configurations, test, ...) and to use the system (visualize and be alerted, ...). Everything can be done through the Mini configuration module (local display, cat. no SXV01). [Refer to the technical sheet dedicated to this module for details].
- No communication Interfaces or gateways are required.
- Installation can be done without the intervention of a System Integrator

Programming procedure:

. For Nemo SX modules which need some: mandatory through the lateral DIP-switches of each Nemo SX module (see § “Module configuration”)

Addressing procedure:

. For all Nemo SX modules: mandatory through the track wheel located on the top upper face of each Nemo SX modules
 . Marked from 0 to 9 in order to locally define the Modbus address of the Nemo SX modules

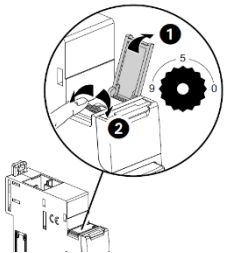

Note for Measure Module “3x single phase”:

This module is to be consider as 3 modules with 3 different Modbus Address. The module takes automatically the two addresses immediately following to the programmed one (e.g. Programmed address = 12, Addresses of the module 12, 13, 14)

Consequences of the local addressing mode (through the track wheel):

- . Each device of the system must be addressed.
- . Addresses available: from 1 to 9
- . Address 0 not permitted
- . It is possible to assign to several devices the same address with the purpose of grouping different functions, **because they are related to the same electrical circuit**. For example, it is possible to assign the same address to a multifunction signalling module (cat. no SXMC02), a multifunction control module (cat. no SXM0C1), a measuring module, and so on. In this way on the Nemo SX mini configuration module (local display) the grouped function will be displayed as a unique “device” with all grouped functions. [Refer to the schemes hereunder]

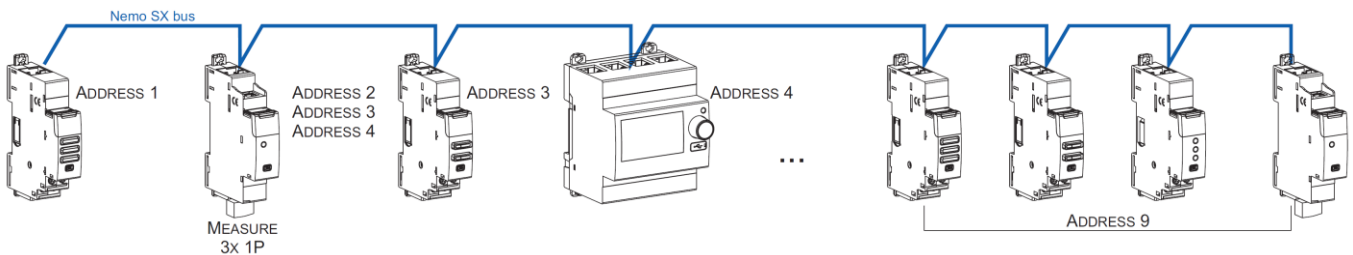

Note for the mini configuration module (local display)

- . It is possible to assign it the same address as another Nemo SX through the programming menu of the device
- . The mini configuration module can be placed everywhere in the Nemo SX bus

6. SYSTEM ARCHITECTURES

6.1 Stand-alone system *(continued)*

6.1.2 Stand-alone system with remote addressing (through a computer)

Remote addressing advantages:

- Whole configuration (addresses and functions) can be set up through the Nemo SX Configuration software
- Configuration software available for free
- **Automatic detection of the Nemo SX modules** installed in the system (characteristics, functions, configuration...)
- **Increased settings possibilities: load shedding function**
- Increased addressing: **up to 30 Modbus addresses in a system**

Programming procedure:

. For Nemo SX modules which need some: possible through the lateral DIP-switches of each Nemo SX module or via the configuration software (see § "Module configuration").

Addressing procedure:

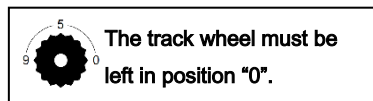
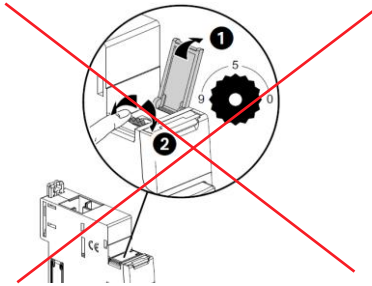

. It is not necessary to address the Nemo SX modules. **The track wheel must be left in default position "0"**.

. All the addressing/configuring procedure will be done with the Configuration Software (available online for free)

. With remote addressing, the software does the automatic detection of modules installed in the system, but the supervision is not possible until the user assigns the remote address and all the characteristics to each module.

Note: it is mandatory to connect the computer to the Mini configuration module with a "type B" micro - USB cable. [For more details, refer to the technical data sheet of the Mini configuration module Nemo SX]

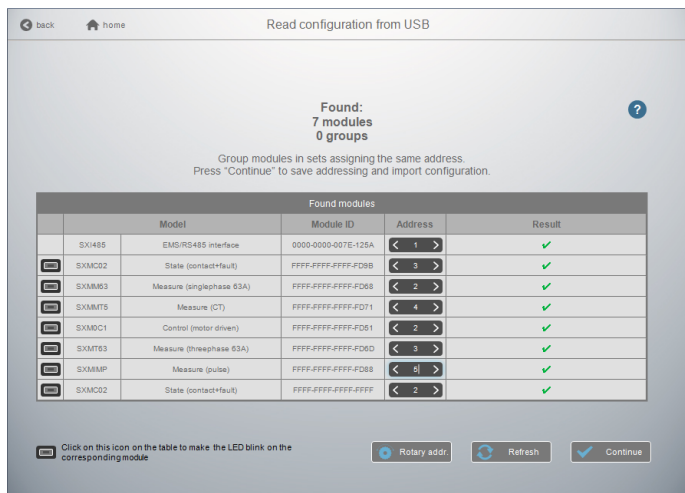
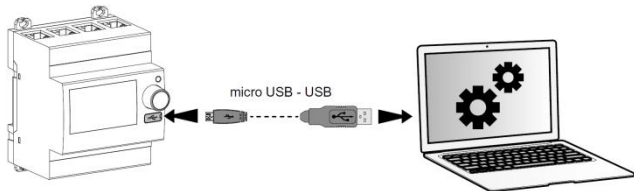

Note for Measure Module "3x single phase":

This module is to be consider as 3 modules with 3 different Modbus Address. The module takes automatically the two addresses immediately following to the programmed one (e.g. Programmed address = 2, Addresses of the module 2, 3, 4)

6. SYSTEM ARCHITECTURES

6.1 Stand-alone system (continued):

6.1.2 Stand-alone system with remote addressing (through a computer) (continued):

Consequences for the system architecture:

- for 1 mini configuration module (cat. no SXV01)
 - o up to **30 Nemo SX modules** (e.g. 30 devices grouped per functions with addresses from 1 to 30)

It is possible to assign to several devices the same address with the purpose of grouping different functions, **because they are related to the same electrical circuit**. For example, it is possible to assign the same address to a multifunction signalling module (cat. no SXMC02), a multifunction control module (cat. no SXM0C1), a measuring module, and so on. In this way on the Nemo SX display or in a supervision system the grouped function will be displayed as a unique “device” with all grouped functions. [Refer to the schemes here under]

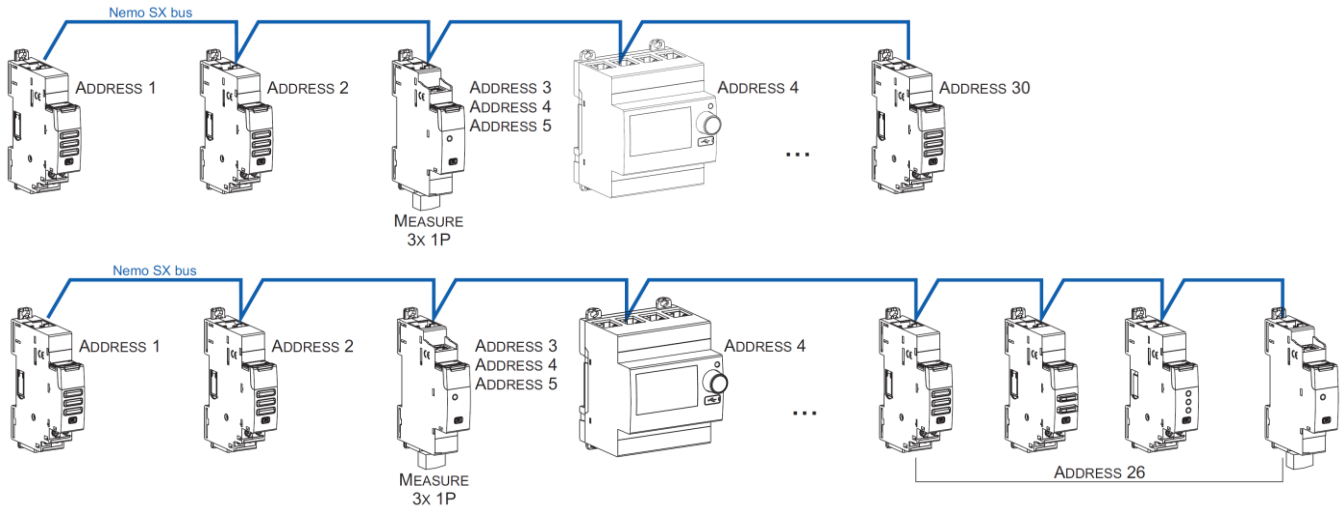

Note for the mini configuration module (local display)

- . It is possible to assign it the same address as another Nemo SX
- . The mini configuration module can be placed everywhere in the Nemo SX bus

6.2 Supervised system (Computer Supervisory System)

. **Supervised system** = System to be used through a Computer Supervisory System to remotely read data from the Nemo SX devices and/or do operations on these devices (e.g. commands of a motor driven or contactor ...).

6.2.1 Supervised system-with local addressing (through the track wheel)

Local addressing advantages:

- No configuration software needed to set-up the installation
- Installation can be done without the intervention of a System Integrator

Programming procedure:

. For Nemo SX modules which need some: mandatory through the lateral DIP-switches of each Nemo SX module (see § "Module configuration")

Addressing procedure:

. For all Nemo SX modules: mandatory through the track wheel located on the top upper face of each Nemo SX module

. Marked from 0 to 9 in order to locally define the Modbus address to Nemo SX modules

In this system the Modbus address of a Nemo SX module device or group of modules (several functions) is obtained considering the address of the interface Modbus/Nemo SX Interface as tenth and the address of a device or group of function as unit (e.g. Interface address 1 = 10 → address of module n°5 = Modbus address 15)

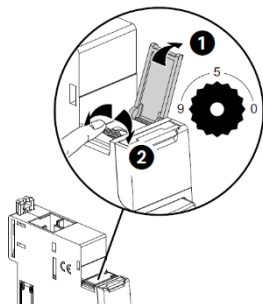

Note for Measure Module “3x single phase”:

This module is to be consider as 3 modules with 3 different Modbus Address. The module takes automatically the two addresses immediately following to the programmed one (e.g. Programmed address = 12, Addresses of the module 12, 13, 14)

6. SYSTEM ARCHITECTURES *(continued)*

6.2 Supervised system (Computer Supervisory System) *(continued)*

6.2.1 Supervised system-with local addressing (through the track wheel) *(continued)*

Consequences of the local addressing mode (through the track wheel):

- . Each device of the system must be addressed.
- . Addresses available: from 1 to 9
- . Address 0 not permitted

It is possible to assign to several devices the same address with the purpose of grouping different functions, **because they are related to the same electrical circuit**. For example, it is possible to assign the same address to a multifunction signalling module (cat. no SXMC02), a multifunction control module (cat. no SXM0C1), a measuring module, and so on. In this way on the Nemo SX display or in a supervision system the grouped function will be displayed as a unique “device” with all grouped functions. *[Refer to the scheme hereunder]*

Note: In this configuration the Modbus address of a Nemo SX module device or group of modules (several functions) is obtained considering the address of the interface Modbus/Nemo SX Interface as tenth and the address of a device or group of function as unit (e.g. Interface address 1 = 10 and device address = 5 → Modbus address = 15)

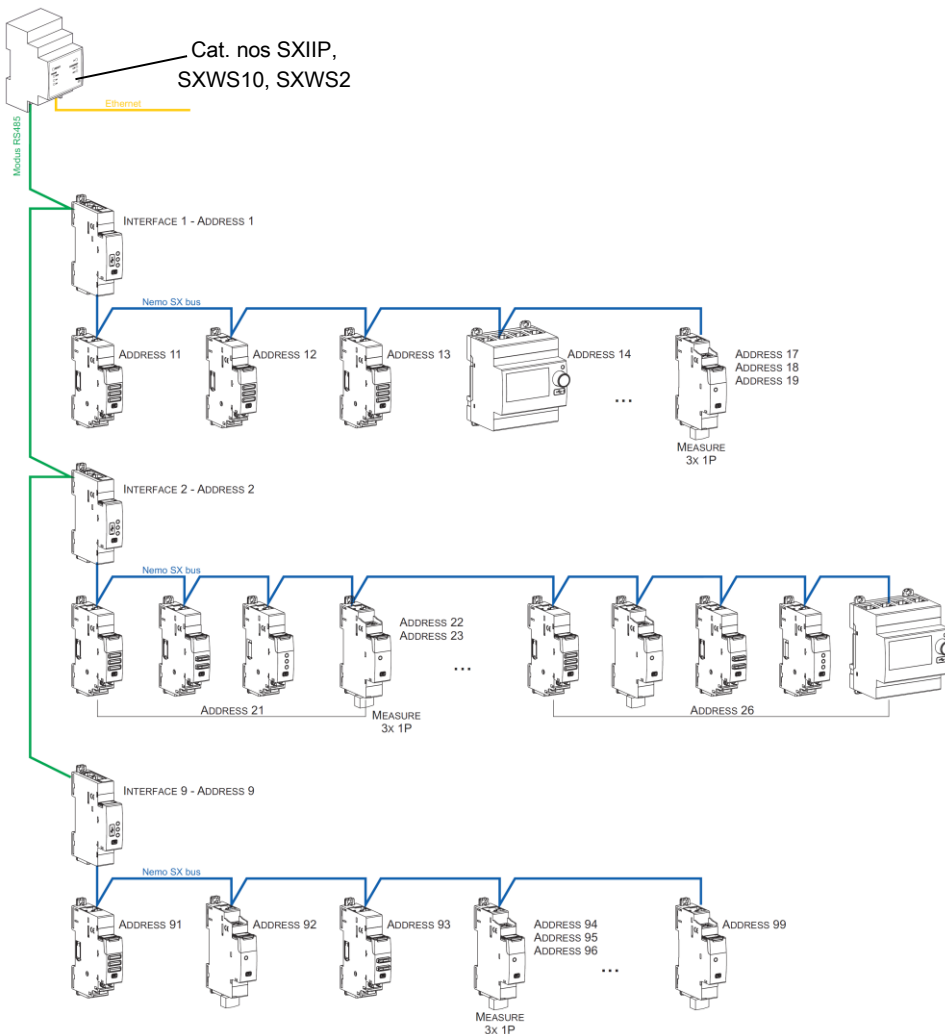

Consequences for the system architecture:

- for 1 IP/Modbus gateway (cat. no SXIIP):
 - o up to **81 Modbus address**
 - o mandatory limit of max. **9 Modbus/Nemo SX interfaces or max. 1000 m of Modbus cable** (cable Belden 9842, Belden 3106A or equivalent) or max. **50 m of Category 6 cable** (FTP or UTP).
- for 1 Modbus/Nemo SX interface (cat. no SXI485):
 - o up to **30 Nemo SX modules** (ex. 30 devices grouped per functions with addresses from 1 to 9)

Note: with local addressing, the Modbus/Nemo SX interface, does the automatic detection of modules (characteristics, functions, configuration...)

6. SYSTEM ARCHITECTURES *(continued)*

6.2 Supervised system (Computer Supervisory System) *(continued)*

6.2.2 Supervised system-with remote addressing (through a computer)

Remote addressing advantages:

- Whole of configuration (addresses and functions) can be done a remotely through the Nemo SX Configuration software
- Configuration software available for free
- **Automatic detection of the Nemo SX modules** installed in the system (characteristics, functions, configuration...)
- **Increased settings possibilities: load shedding function**
- Increased addressing: **up to 32 Modbus/Nemo SX interfaces**
- Increased addressing: **up to 247 Modbus addresses in a system**

Programming procedure:

. For Nemo SX modules which need some: possible through the lateral DIP-switches of each Nemo SX module or via the configuration software *(see § "Module configuration")*.

Addressing procedure:

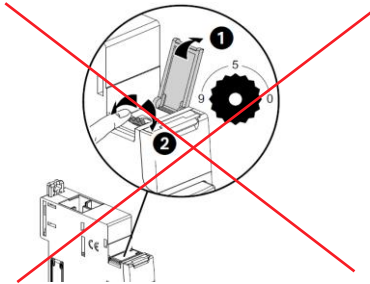

The track wheel must be left in position "0".

. It is not necessary to address the Nemo SX modules. **The track wheel must be left in default position "0".**

. All the addressing/configuring procedure will be done with the Configuration Software (available online for free)

. With remote addressing, the software does the automatic detection of modules installed in the system, but the supervision is not possible until the user assigns the remote address and all the characteristics to each module.

Note: it is mandatory to connect the computer to the different Modbus/Nemo SX interface with a "Type B" micro USB - USB cable (one interface at a time). *[For more details, refer to the technical sheet Modbus/Nemo SX interface]*

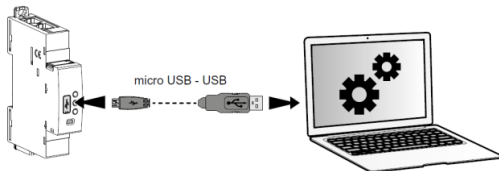

Read configuration from USB

Found:
7 modules
0 groups

Group modules in sets assigning the same address.
Press "Continue" to save addressing and import configuration.

Found modules				
	Model	Module ID	Address	Result
	SXI485	EMS-RS485 interface	0000-0000-0075-125A	< 1 > ✓
	SXMC02	State (contact+fault)	FFFF-FFFF-FFFF-FD0B	< 3 > ✓
	SXMM63	Measure (singlephase 63A)	FFFF-FFFF-FFFF-FD08	< 2 > ✓
	SXMMT5	Measure (CT)	FFFF-FFFF-FFFF-FD71	< 4 > ✓
	SXMC01	Control (motor driven)	FFFF-FFFF-FFFF-FD81	< 2 > ✓
	SXMT63	Measure (threephase 63A)	FFFF-FFFF-FFFF-FD0D	< 3 > ✓
	SXMM6P	Measure (pulse)	FFFF-FFFF-FFFF-FD03	< 4 > ✓
	SXMC02	State (contact+fault)	FFFF-FFFF-FFFF-FFFF	< 2 > ✓

Click on this icon on the table to make the LED blink on the corresponding module

Rotary addr. Refresh Continue

Note for Measure Module "3x single phase":

This module is to be consider as 3 modules with 3 different Modbus Address. The module takes automatically the two addresses immediately following to the programmed one (e.g. Programmed address = 2, Addresses of the module 2, 3, 4)

6. SYSTEM ARCHITECTURES *(continued)*

6.2 Supervised system (Computer Supervisory System) *(continued)*

6.2.2 Supervised system-with remote addressing (through a computer) *(continued)*

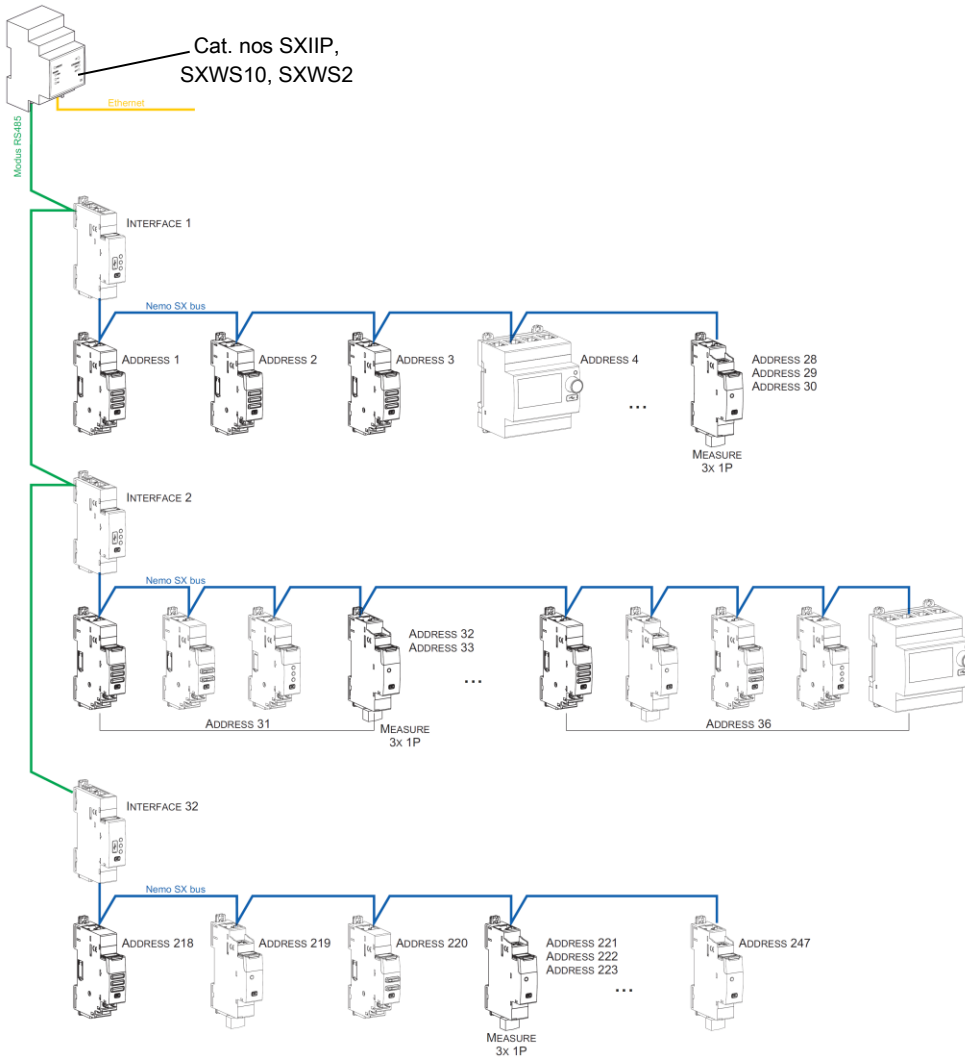

Consequences for the system architecture:

- for 1 IP/Modbus gateway (cat. no SXIIP):
 - o up to **247 Modbus address**
 - o Because of Modbus: mandatory limit of max. **32 Modbus/Nemo SX interfaces** or max. **1000 m of Modbus cable** (cable Belden 9842, Belden 3106A or equivalent) or max. **50 m of Category 6 cable** (FTP or UTP).
- for 1 Modbus/Nemo SX Interface (cat. no SXI485):
 - o up to **30 Nemo SX modules or grouped modules** (e.g. 30 devices grouped per functions with addresses from 1 to 30)

It is possible to assign to several devices the same address with the purpose of grouping different functions, **because they are related to the same electrical circuit**. For example, it is possible to assign the same address to a multifunction signalling module (cat. no SXMC02), a multifunction control module (cat. no SXM0C1), a measuring module, and so on. In this way on the Nemo SX display or in a supervision system the grouped function will be displayed as a unique "device" with all grouped functions. *[Refer to the scheme up here]*

7. COMPLIANCE AND APPROVALS

Compliance to standards:

- . Compliance with Directive on electromagnetic compatibility (EMC) n° 2014/30/EU
- . Compliance with low voltage directive n° 2014/35/EU.
- . Electromagnetic Compatibility:
 - emission according IEC/EN 61326-1, class B
 - immunity according IEC/EN 61326-1.

Conformity table to IEC 61557-12 Edition 2 (2018/10/22)

Performance measuring and monitoring devices (PMD) characteristics		
Type of characteristic	Specification values	Other complementary characteristics
Classification of PMD according 4.3	PMD-x (*)	-
Classification of PMD according 4.4	DD	-
Temperature	K55	-
Humidity + Altitude	Standard conditions	-
Active power and Active energy function performance class	0,5	-

(*) PMD-III without Eap

Nemo SX - Multifunction Measuring module with closed Rogowski coils

Cat. Nos: SX3M63, SXMM63, SXMT63, SXMT125, ROGEXTM1, ROGEXTM3

7. COMPLIANCE AND APPROVALS *(continued)*

Conformity table to IEC 61557-12 Edition 2 (2018/10/22) *(continued)*

Function symbols	Function performance class according to IEC 61557-12	Measuring range	Other complementary characteristics
P	0,5	1,0 ÷ 75 A (SX...63) 2,0 ÷ 150 A (SXMT125)	-
Q _v	1	2,0 ÷ 75 A (SX...63) 4,0 ÷ 150 A (SXMT125)	-
S _A	0,5	1,0 ÷ 75 A (SX...63) 2,0 ÷ 150 A (SXMT125)	-
E _a	0,5	1,0 ÷ 75 A (SX...63) 2,0 ÷ 150 A (SXMT125)	-
E _{rV}	2	2,0 ÷ 75 A (SX...63) 4,0 ÷ 150 A (SXMT125)	-
E _{apA} , E _{apV}	-	-	-
f	0,1	45 ÷ 65 Hz	-
I	0,5	2,0 ÷ 75 A (SX...63) 4,0 ÷ 150 A (SXMT125)	-
I _{nc}	0,5	2,0 ÷ 75 A (SX...63) 4,0 ÷ 150 A (SXMT125)	-
U, V	0,5	65 ÷ 290 V (Ph-N) 110 ÷ 500 V (Ph-Ph)	-
P _{FA}	0,5	Over 360 degrees	-
U _{dip}	-	-	-
U _{swf}	-	-	-
U _{tr}	-	-	-
U _{int}	-	-	-
U _{nba}	-	-	-
U _{nb}	-	-	-
V _h	2	65 ÷ 290 V (Ph-N) 110 ÷ 500 V (Ph-Ph)	-
THD _u , THD _v	1	65 ÷ 290 V (Ph-N) 110 ÷ 500 V (Ph-Ph)	-
THD-R _u	-	-	-
I _h	5	6,3 ÷ 75 A (SX...63) 15,5 ÷ 150 A (SXMT125)	-
THD _i	1	6,3 ÷ 75 A (SX...63) 15,5 ÷ 150 A (SXMT125)	-
THD-R _i	-	-	-
P _{st}	-	-	-
P _{It}	-	-	-

7. COMPLIANCE AND APPROVALS *(continued)*

Environment respect - Compliance with EU directives:

- . Compliance with Directive 2011/65/EU as amended by Directive 2015/863 (RoHS 2) on the restriction of the use of certain hazardous substances in electrical and electronic equipment.
- . Compliance with REACH regulation (1907/2006): at the date of the publication of this document no element of the SVHC substance list (updated on 27/06/2018) is present in these products.
- . WEEE directive (2012/19/EU): the sale of this product is subject to a contribution to eco-organisations in each country responsible for managing end-of-life products in the field of application of the European Waste Electronic and Electrical Equipment Directive.

Plastic materials:

- . Halogens-free plastic materials.
- . Marking of parts according to ISO 11469 and ISO 1043.

Packaging:

- . Design and manufacture of packaging compliant to decree 98-638 of the 20/07/98 and also to directive 94/62/CE.