

Tools

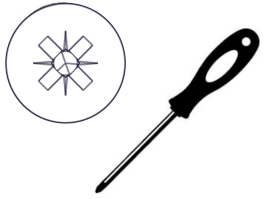

PZ-2

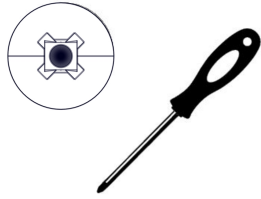

SR-1

Components

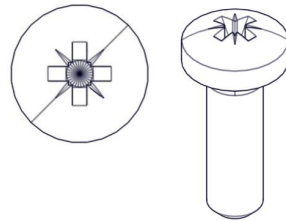
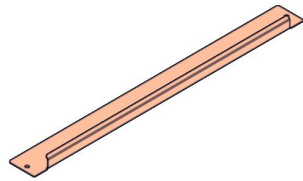
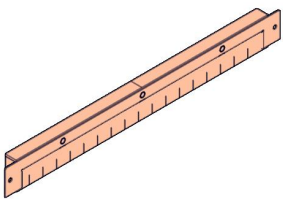

M5 x 12 (PZ-2)

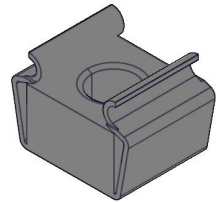

M5

1.1

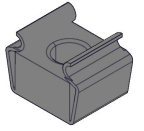
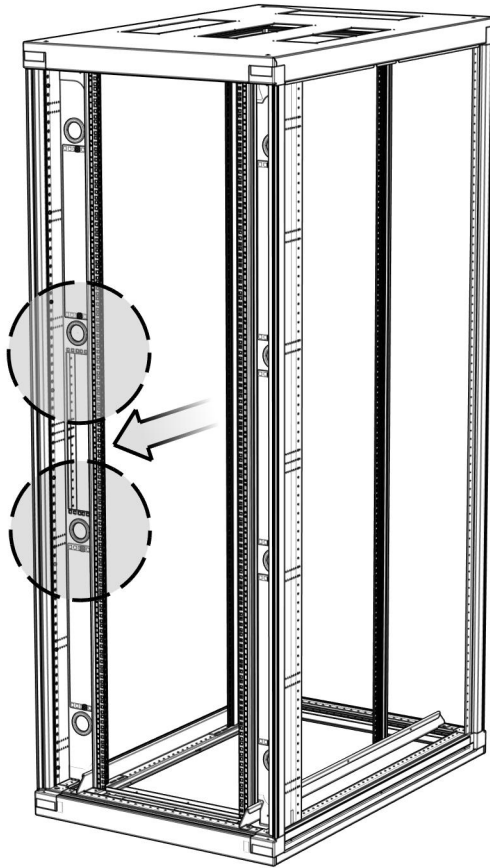
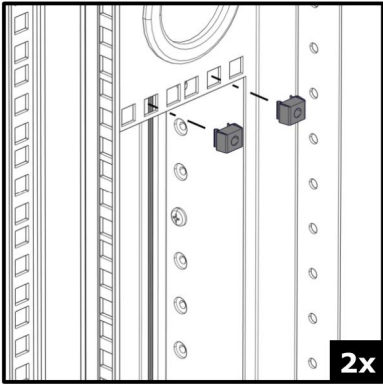

M5

P-00047-2/000182-2

1.2

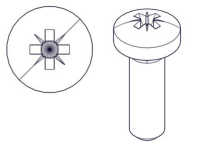
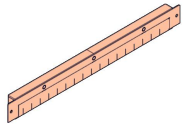
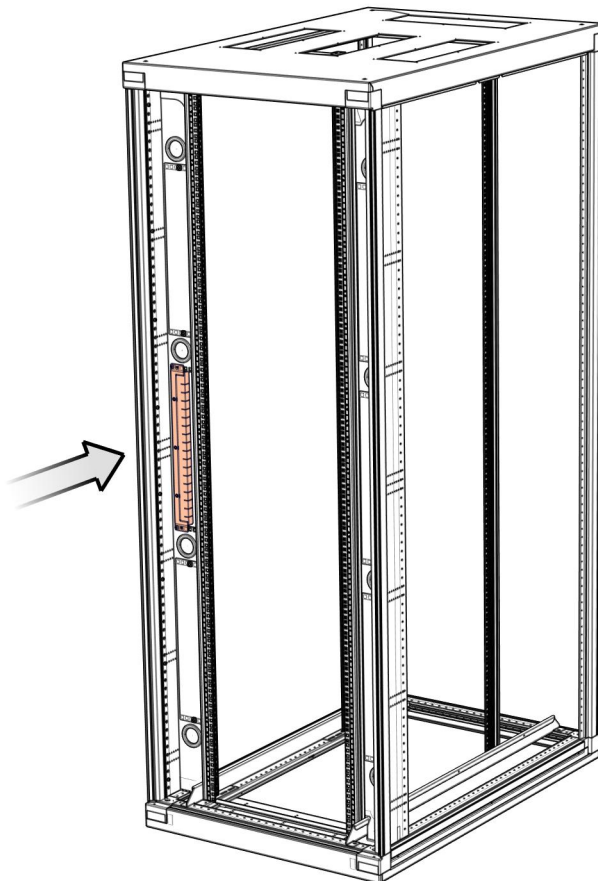
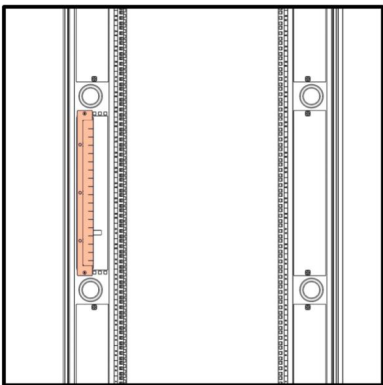
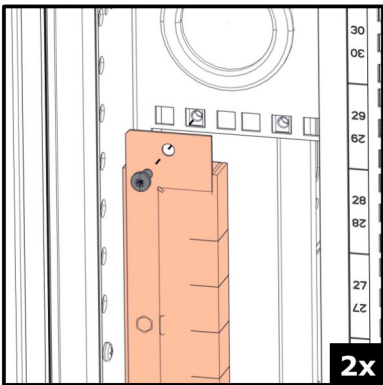

M5 x 12 (PZ-2)

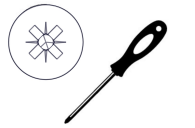

PZ-2

P-00047-2/000182-2

1.3

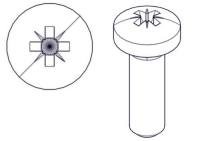
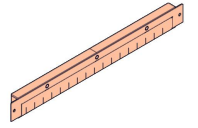
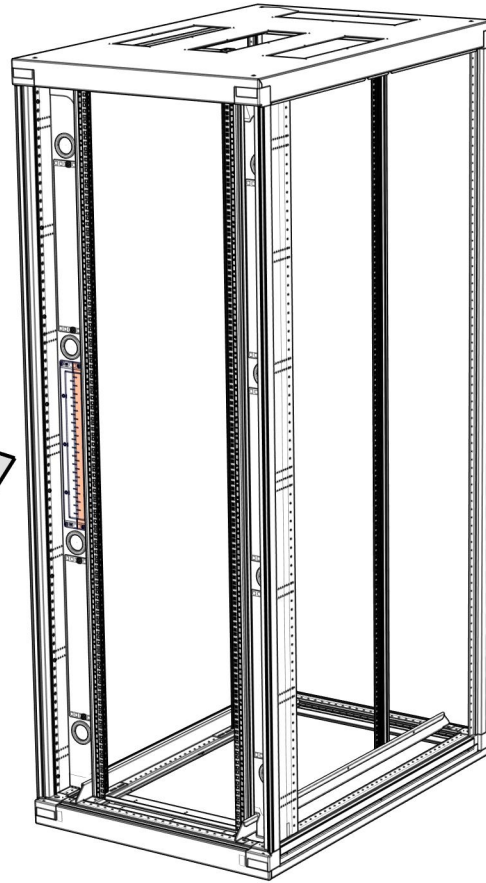
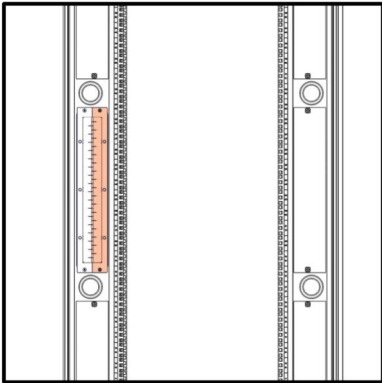
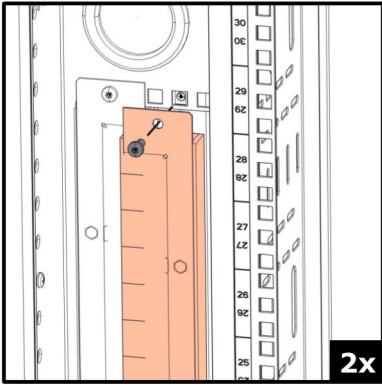

M5 x 12 (PZ-2)

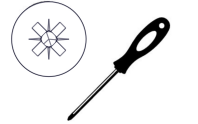

PZ-2

P-00047-2/000182-2

1.4

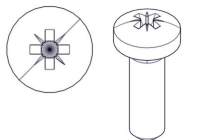
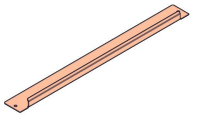
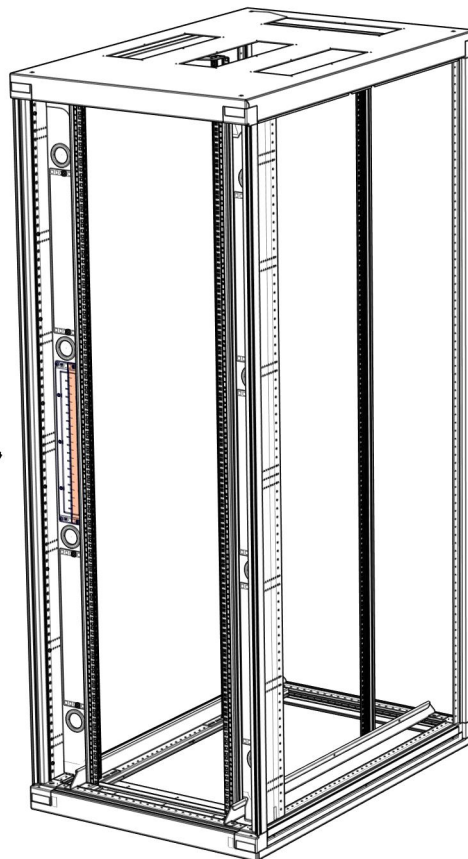
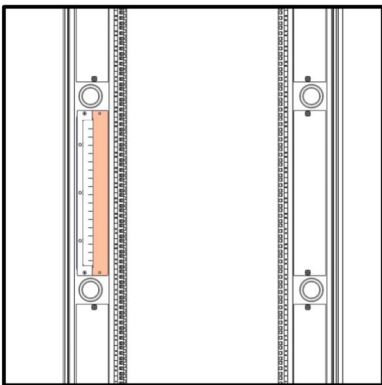
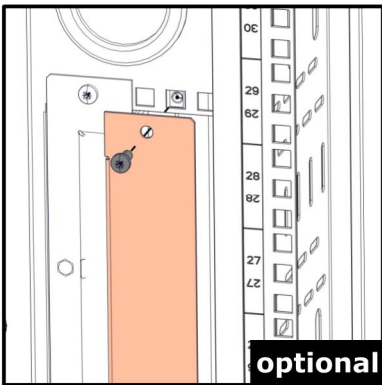

M5 x 12 (PZ-2)

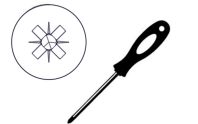

PZ-2

P-00047-2/000182-2

2.1

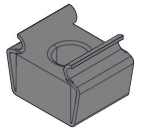
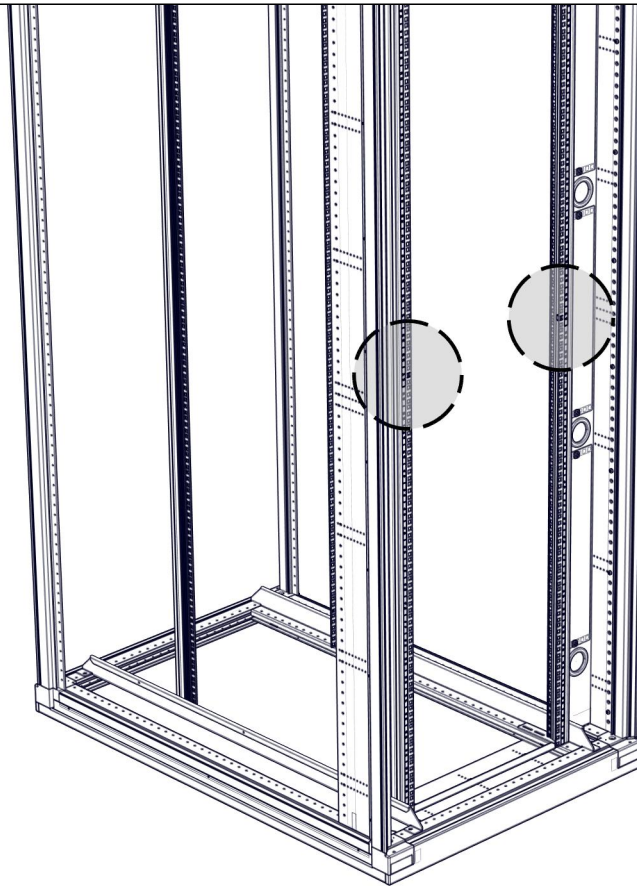
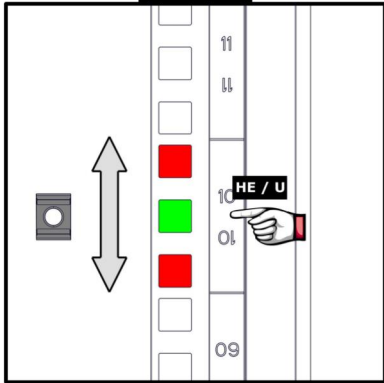
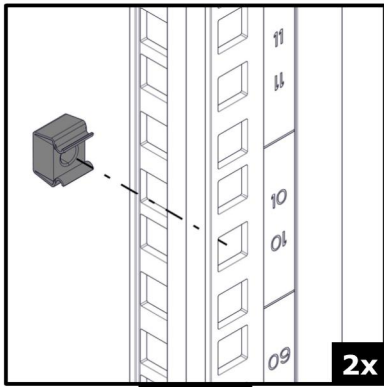

M5

P-00047-2/000183-2

2.2

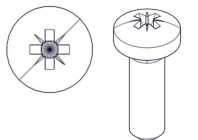
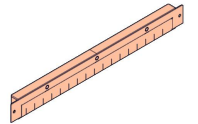
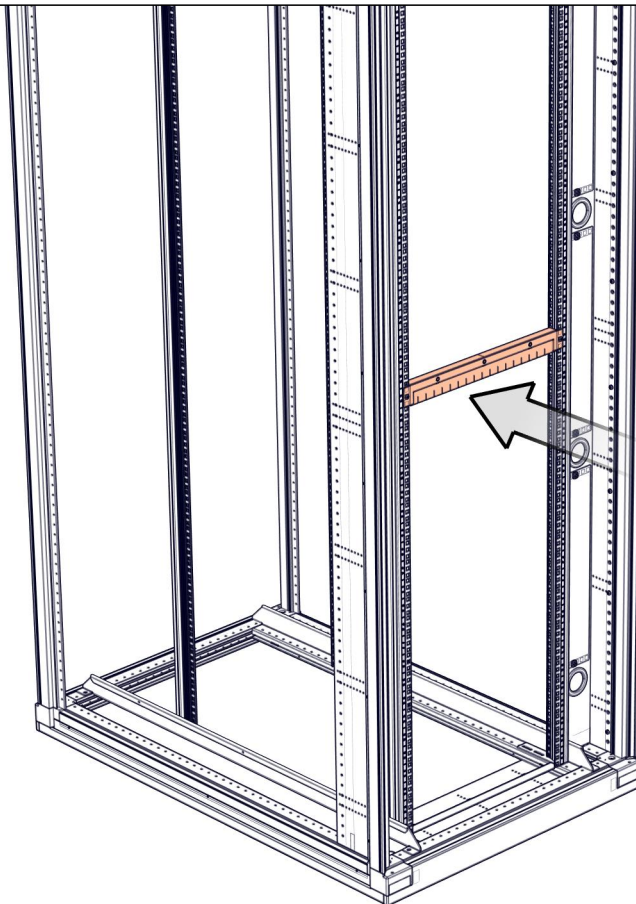
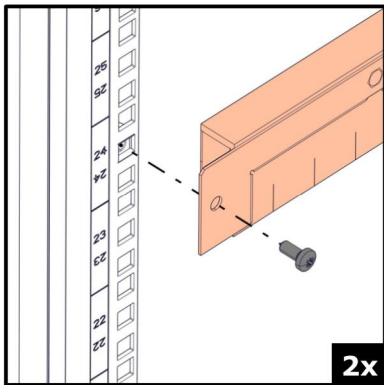

M5 x 12 (PZ-2)



PZ-2

P-00047-2/000183-2



Head office
and International Department
87045 Limoges Cedex - France
Tel: + 33 (0) 5 55 06 87 87
Fax: + 33 (0) 5 55 06 74 55