

Tools

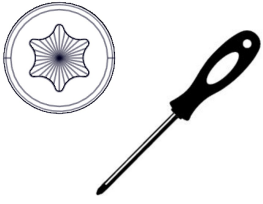

T25

Components

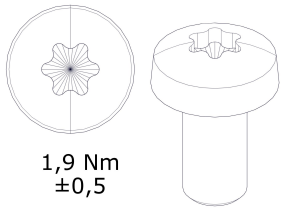

1,9 Nm
 $\pm 0,5$

M5 x 10 (T25)

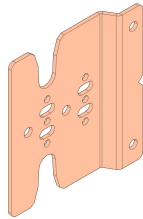

100b8-000001

1.1

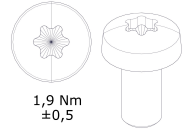
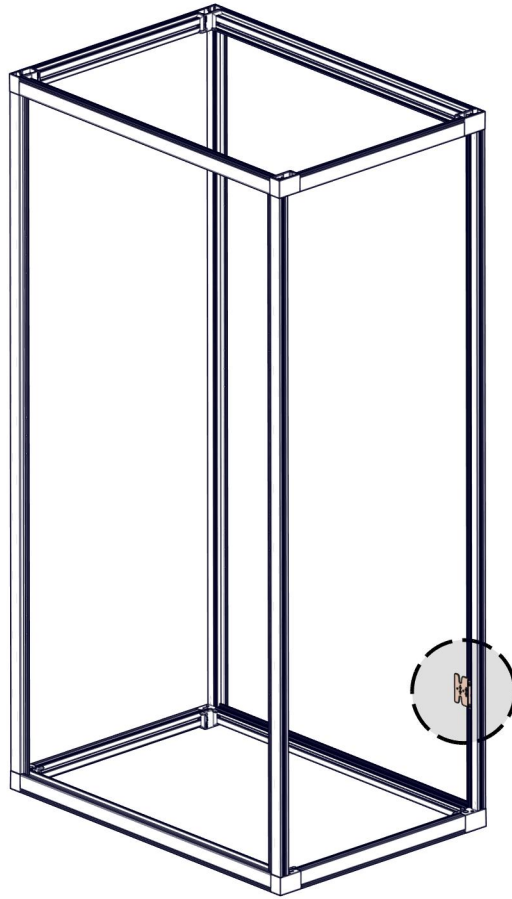
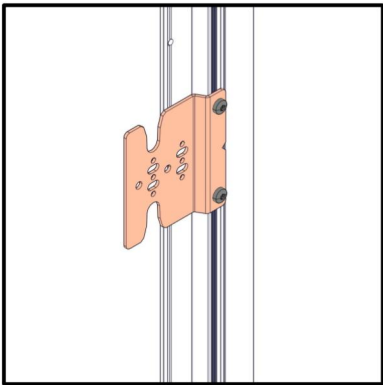
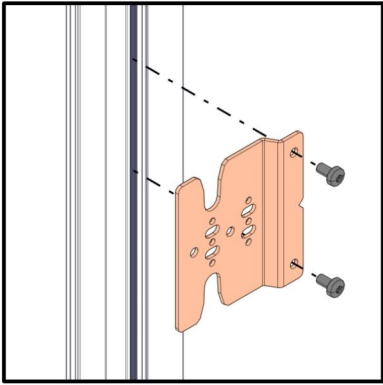

1,9 Nm
±0,5

M5 x 10 (T25)

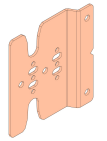

100b8-00001



T25

NI-000049-2/000950-1

1.2

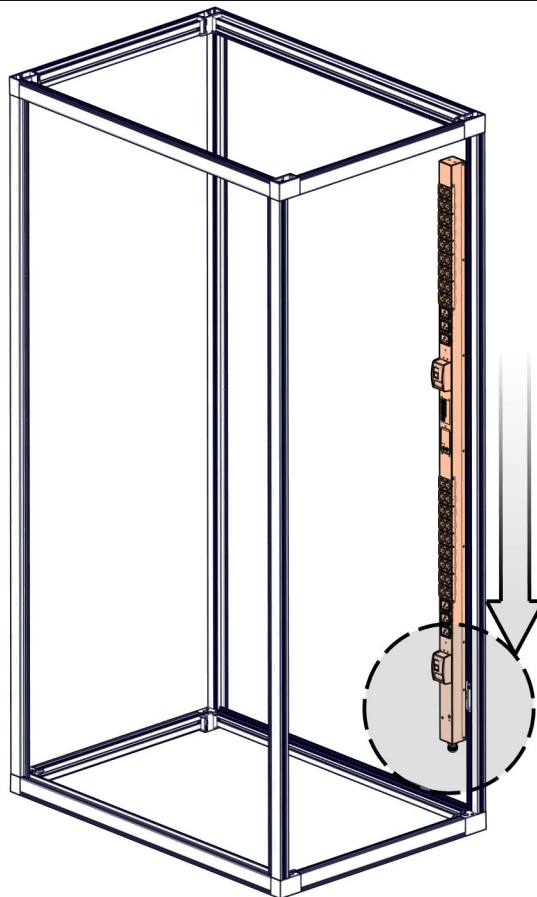
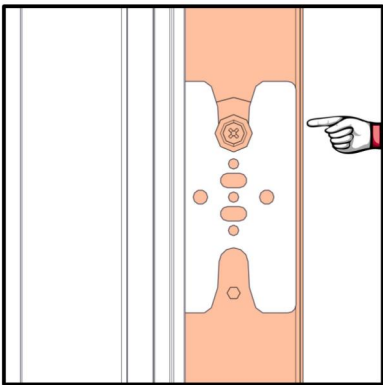

NI-000049-2/000950-1

1.3

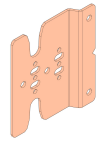
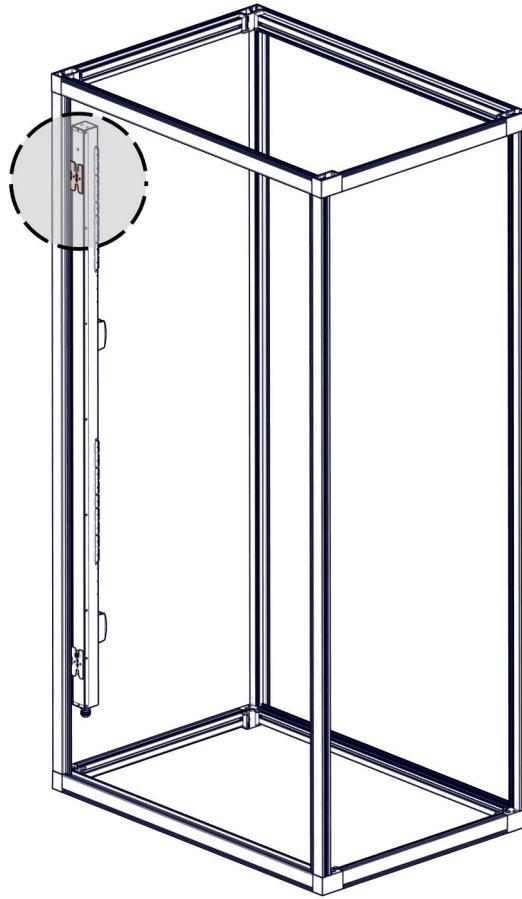
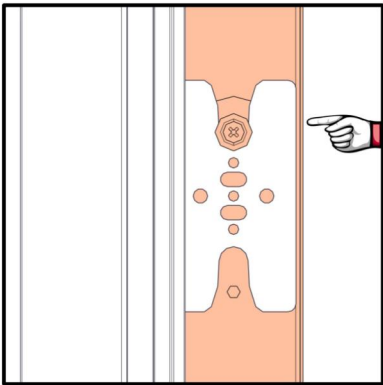
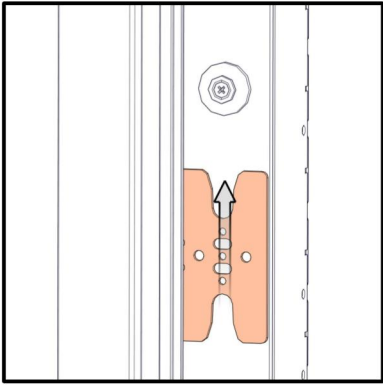

100b8-000001

NI-000049-2/000950-1

1.4

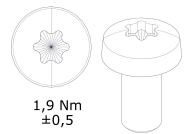
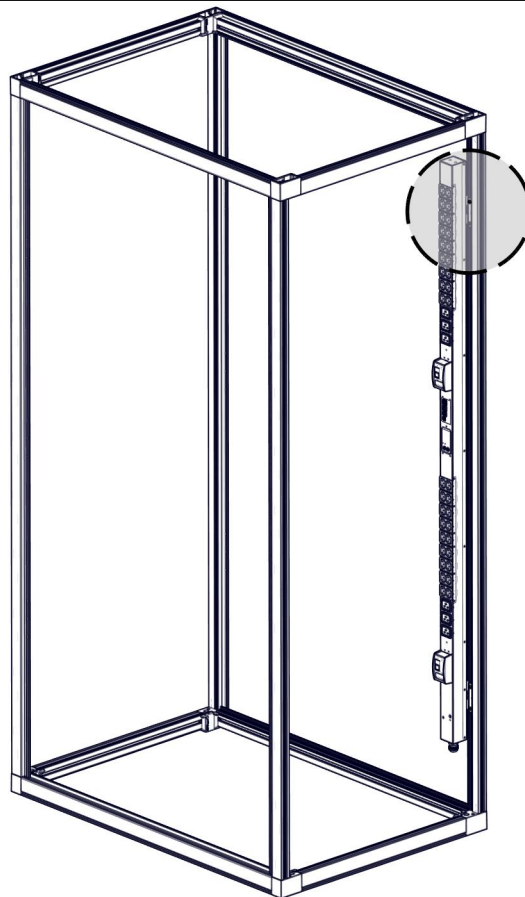
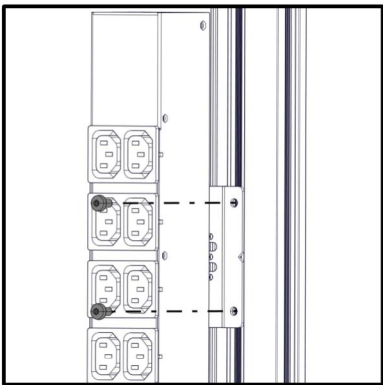

1,9 Nm
±0,5

M5 x 10 (T25)



T25

NI-000049-2/000950-1

Notes



Head office
and International Department
87045 Limoges Cedex - France
Tel: + 33 (0) 5 55 06 87 87
Fax: + 33 (0) 5 55 06 74 55