

Tools

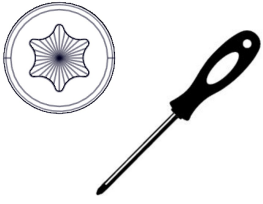

T25

Components

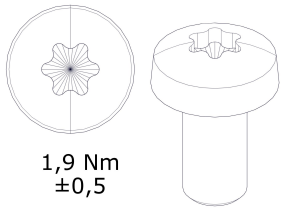

1,9 Nm
 $\pm 0,5$

M5 x 10 Tapt (T25)

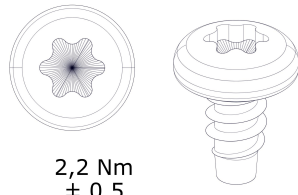

2,2 Nm
 $\pm 0,5$

ST 4,2 x 8 (T25)

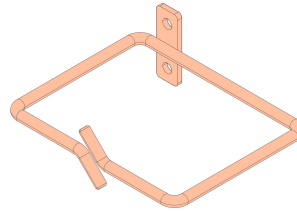

1008F

1.1

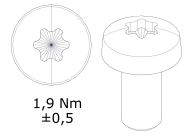
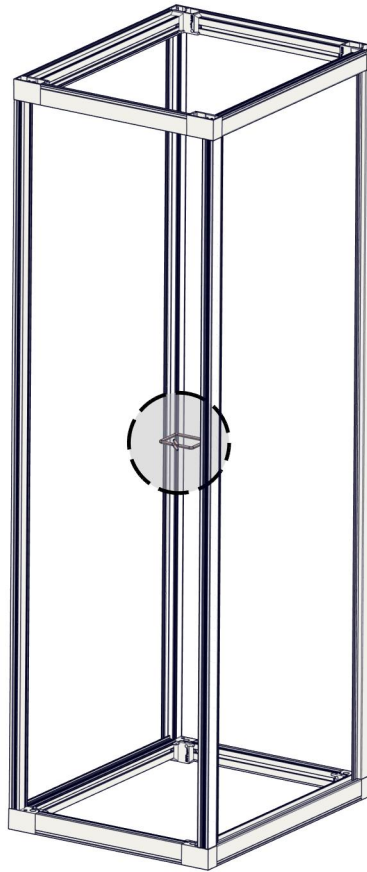
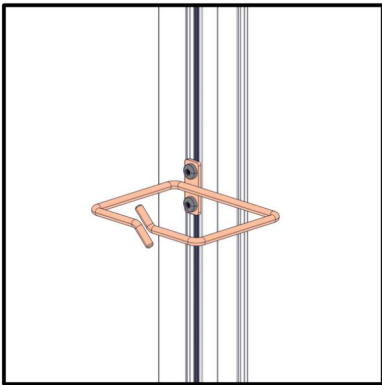
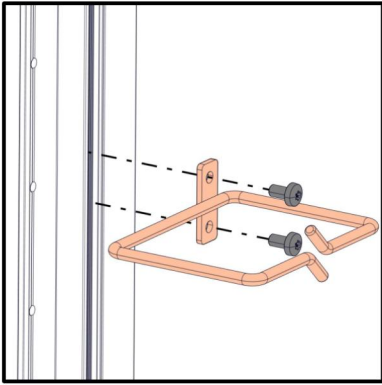

1,9 Nm
±0,5

M5 x 10 Tapt (T25)

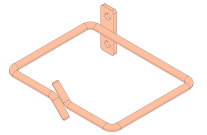

1008F

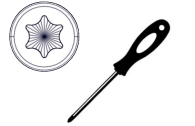

T25

NI-000045-3/000946-2

1.2

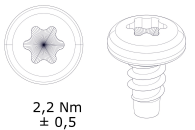
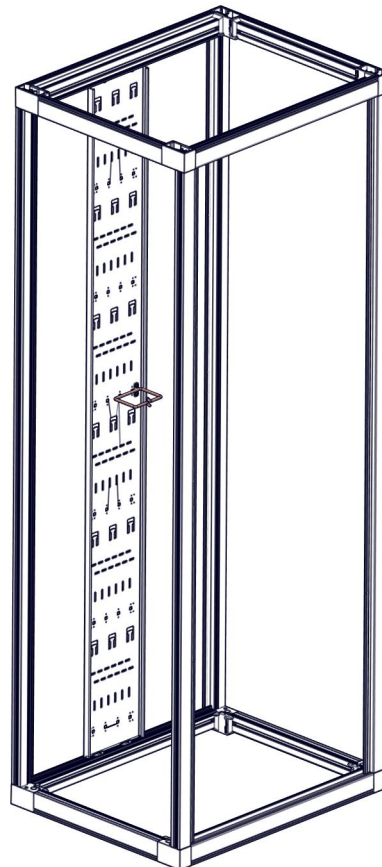
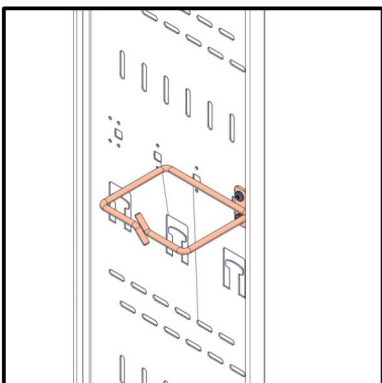
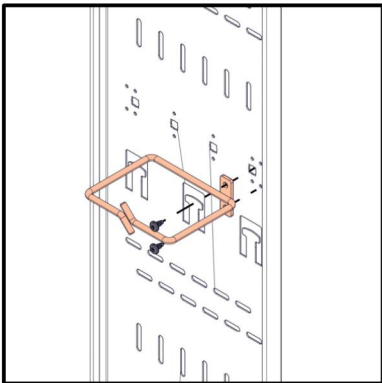

2,2 Nm
± 0,5

ST 4,2 x 8 (T25)

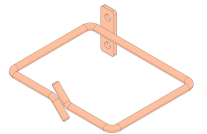

1008F



T25

NI-000045-3/000946-2

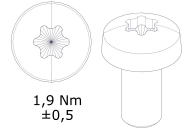
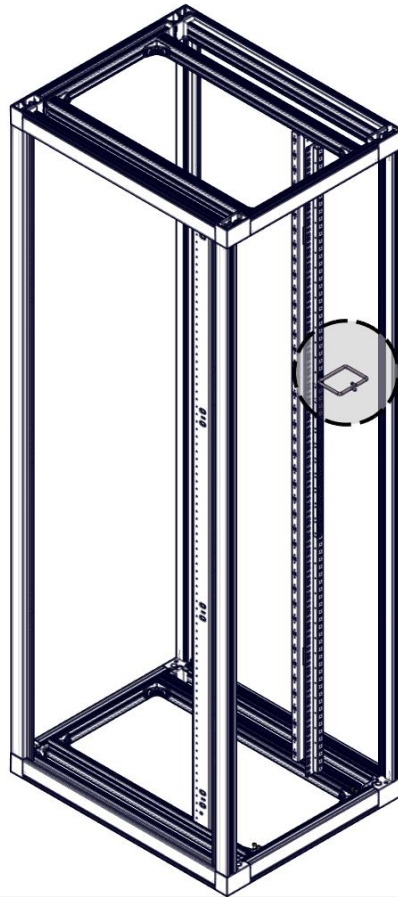
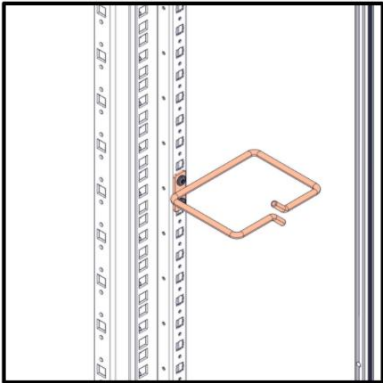
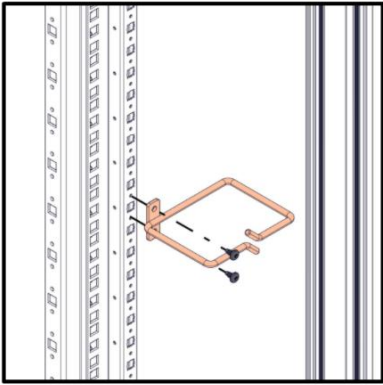

1,9 Nm
±0,5

M5 x 10 Tapt (T25)

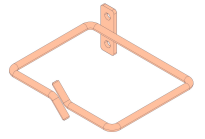

1008F



T25

NI-000045-3/000946-2



Head office
and International Department
87045 Limoges Cedex - France
Tel: + 33 (0) 5 55 06 87 87
Fax: + 33 (0) 5 55 06 74 55