

P31 - CHEMIN DE CÂBLES SYMÉTRIQUE (33X60)
P31 - SYMMETRICAL CABLE TRAYS (33x60)

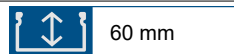

CHEMIN DE CÂBLES TÔLE PERFORÉE SYMÉTRIQUE (33X60)
PERFORATED SYMMETRICAL CABLE TRAYS (33X60)

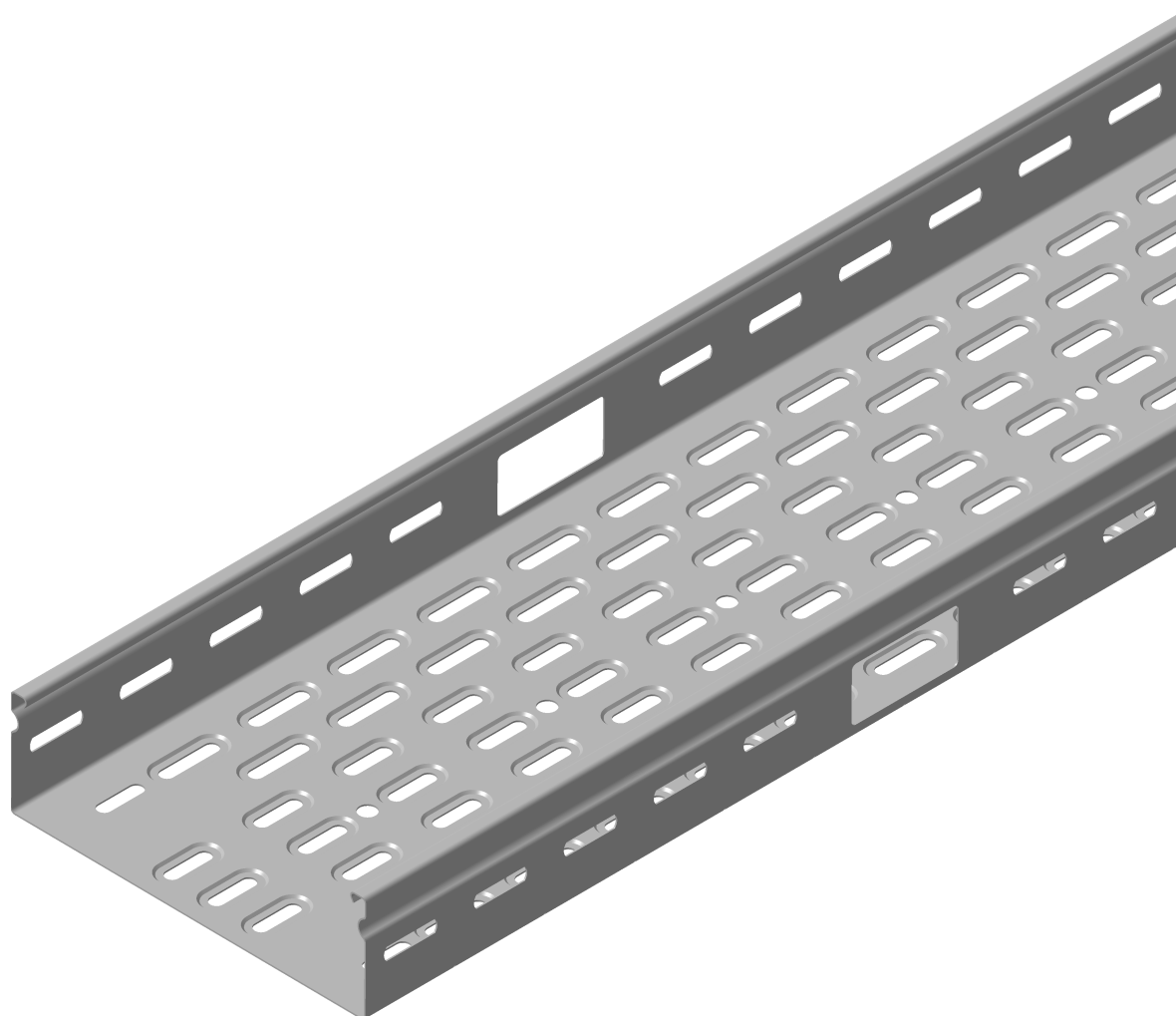

P31 - CHEMIN DE CÂBLES SYMÉTRIQUE (33X60)
P31 - SYMMETRICAL CABLE TRAYS (33x60)

Référence(s): **487054**
Item(s): **487055**
487056
487057
487058
487059

1. GAMME/RANGE
GS / PG



<->
75
Plat
Flat

<->
100
Plat
Flat

<->
150
Plat
Flat

<->
200
Embouti
Embossing

<->
300
Embouti
Embossing

<->
400
Embouti
Embossing

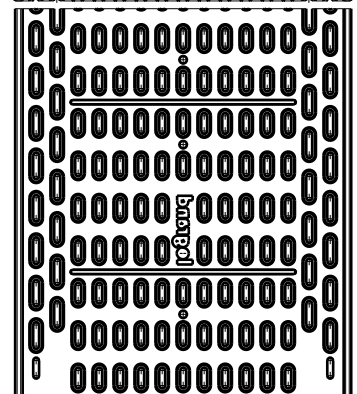
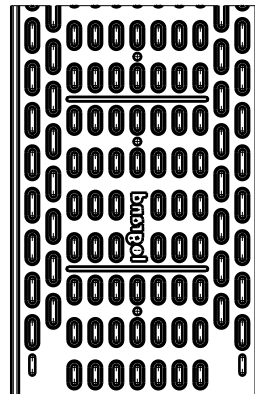
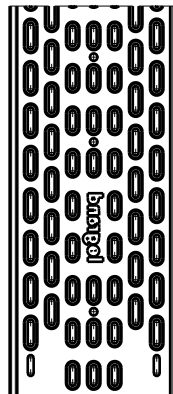
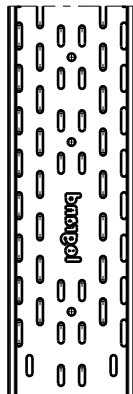
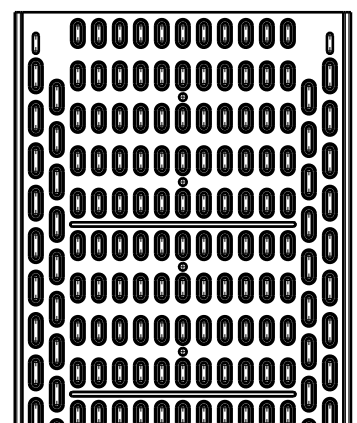
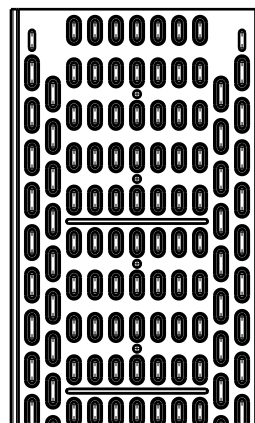
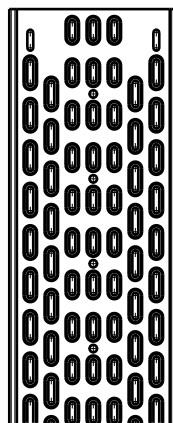
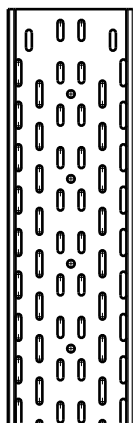
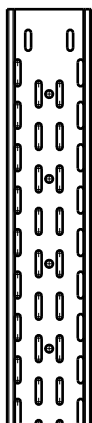

P31 - CHEMIN DE CÂBLES SYMÉTRIQUE (33X60)
P31 - SYMMETRICAL CABLE TRAYS (33x60)

 Référence(s): **487054**
 Item(s): **487055**
487056
487057
487058
487059
CHEMIN DE CÂBLES SYMÉTRIQUE TÔLE PERFORÉE (33X60) GS 3M (3030mm)
PERFORATED SYMMETRICAL CABLE TRAYS (33X60) PG 3M (3030mm)

Designation Description	Code	Poids Weight (Kg)	Épaisseur Thickness (mm)	Matière Raw Material	Norme matière Standard Raw Material	Finition Coating	Norme Finition Standard Coating	Section (mm ²)
P31-DALLE 3M 60X75 SYMM (33x60) GS P31-TRAY PERF 60X75 SYMM (33x60) PG	487054	2,75	0,6	DX51D + Z200	EN 10346	GS/PG/Z	EN 10346	4458
P31-DALLE 3M 60X100 SYMM (33x60) GS P31-TRAY PERF 60X100 SYMM (33x60) PG	487055	3,08	0,6	DX51D + Z200	EN 10346	GS/PG/Z	EN 10346	5809
P31-DALLE 3M 60X150 SYMM (33x60) GS P31-TRAY PERF 60X150 SYMM (33x60) PG	487056	3,70	0,6	DX51D + Z200	EN 10346	GS/PG/Z	EN 10346	8749
P31-DALLE 3M 60X200 SYMM (33x60) GS P31-TRAY PERF 60X200 SYMM (33x60) PG	487057	4,45	0,8	DX51D + Z200	EN 10346	GS/PG/Z	EN 10346	11689
P31-DALLE 3M 60X300 SYMM (33x60) GS P31-TRAY PERF 60X300 SYMM (33x60) PG	487058	5,70	0,9	DX51D + Z200	EN 10346	GS/PG/Z	EN 10346	17569
P31-DALLE 3M 60X400 SYMM (33x60) GS P31-TRAY PERF 60X400 SYMM (33x60) PG	487059	10,50	0,9	DX51D + Z200	EN 10346	GS/PG/Z	EN 10346	23175

 Classe de résistance contre la corrosion 3 (IEC 61537)
 Corrosion resistance classification 3 (IEC 61537)

P31 - CHEMIN DE CÂBLES SYMÉTRIQUE (33X60)
P31 - SYMMETRICAL CABLE TRAYS (33x60)

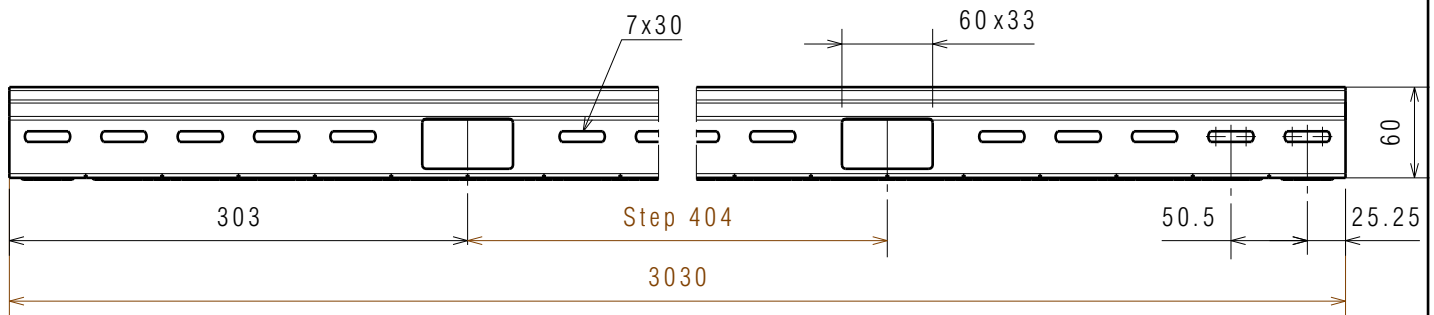
 Référence(s): **487054**
 Item(s): **487055**
487056
487057
487058
487059
2. DIMENSIONS (mm)

Designation Description	Largeur Width W (mm)
P31-DALLE 3M 60X75 SYMM (33x60) GS	77
P31-TRAY PERF 60X75 SYMM (33x60) PG	
P31-DALLE 3M 60X100 SYMM (33x60) GS	100
P31-TRAY PERF 60X100 SYMM (33x60) PG	
P31-DALLE 3M 60X150 SYMM (33x60) GS	150
P31-TRAY PERF 60X150 SYMM (33x60) PG	
P31-DALLE 3M 60X200 SYMM (33x60) GS	200
P31-TRAY PERF 60X200 SYMM (33x60) PG	
P31-DALLE 3M 60X300 SYMM (33x60) GS	300
P31-TRAY PERF 60X300 SYMM (33x60) PG	
P31-DALLE 3M 60X400 SYMM (33x60) GS	400
P31-TRAY PERF 60X400 SYMM (33x60) PG	

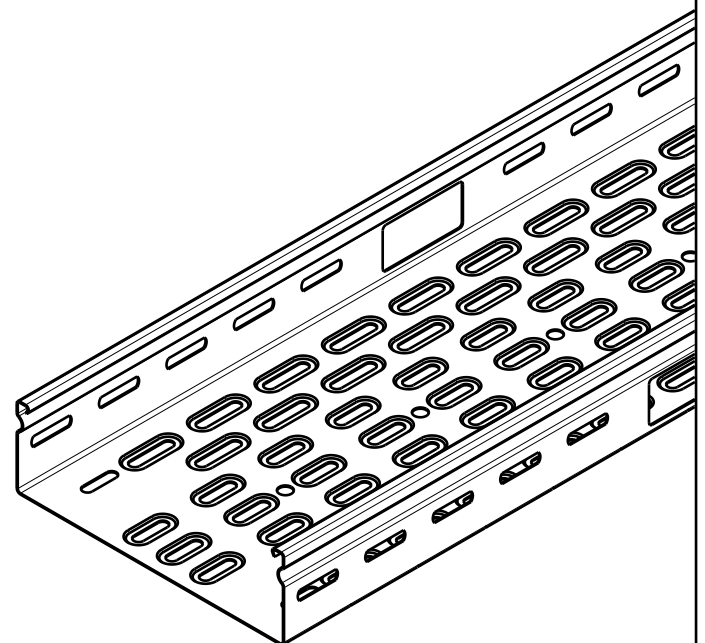
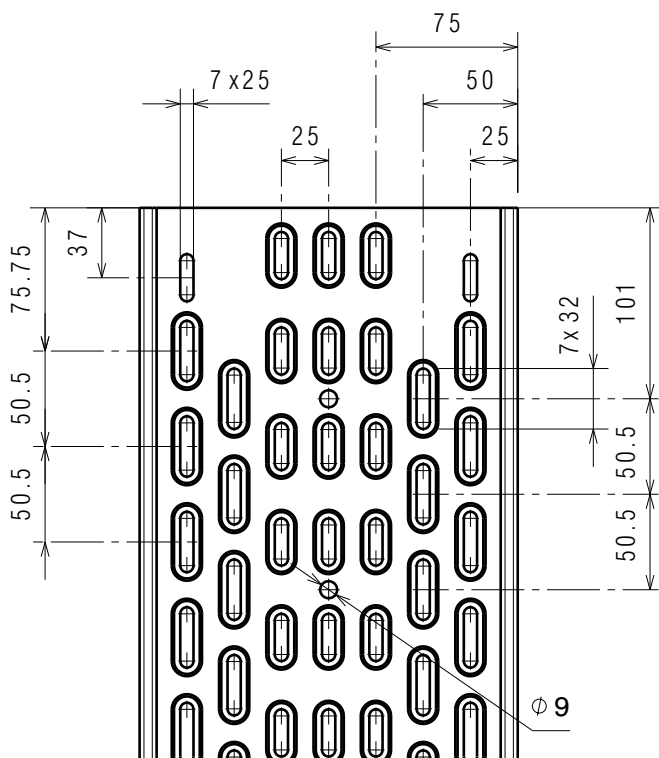
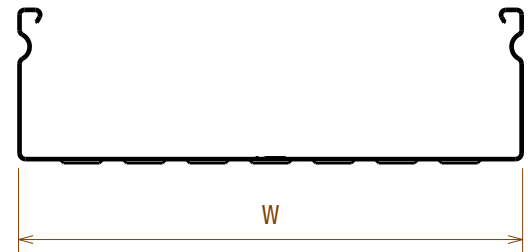

P31 - CHEMIN DE CÂBLES SYMÉTRIQUE (33X60)
P31 - SYMMETRICAL CABLE TRAYS (33X60)

Référence(s): **487054**
Item(s): **487055**
487056
487057
487058
487059

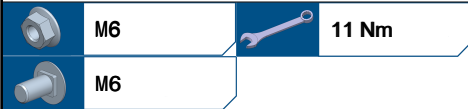

Référence(s): **341895 (GS/PG)**
Item(s):

3. INSTALLATION

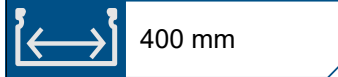
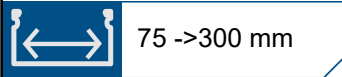

Eclic Coupler
LG-480221

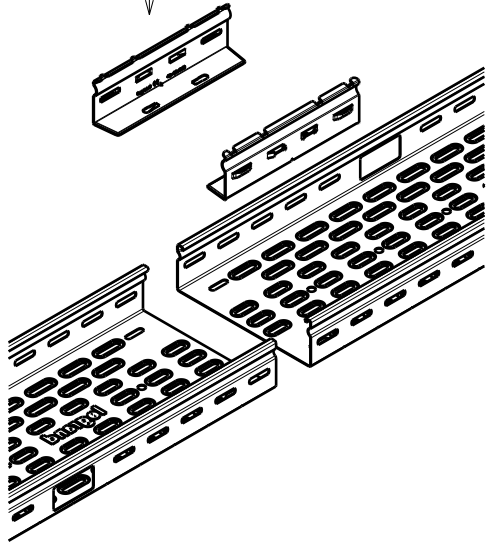

Eclic Coupler
LG-480221

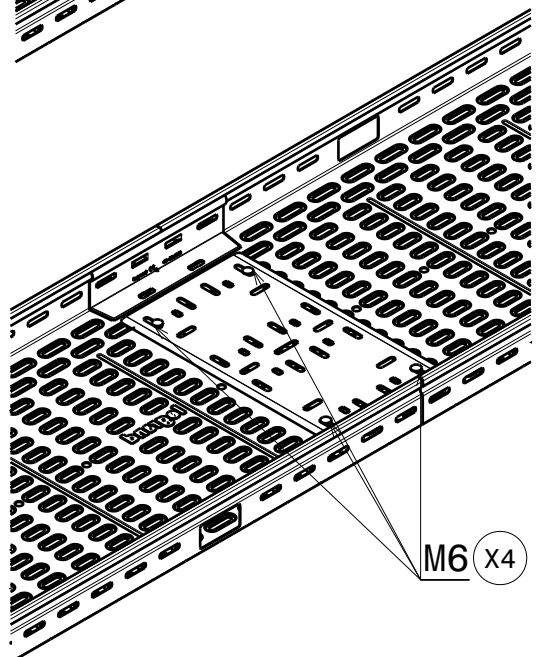
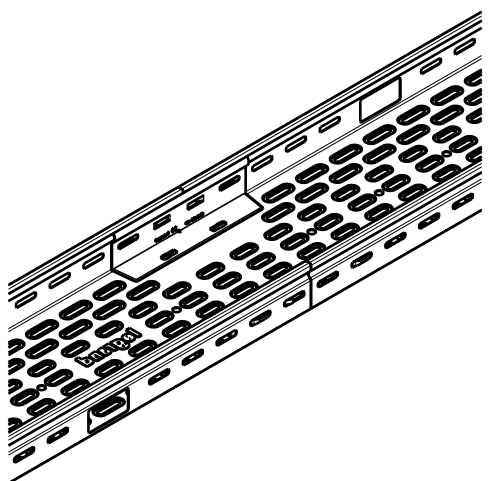
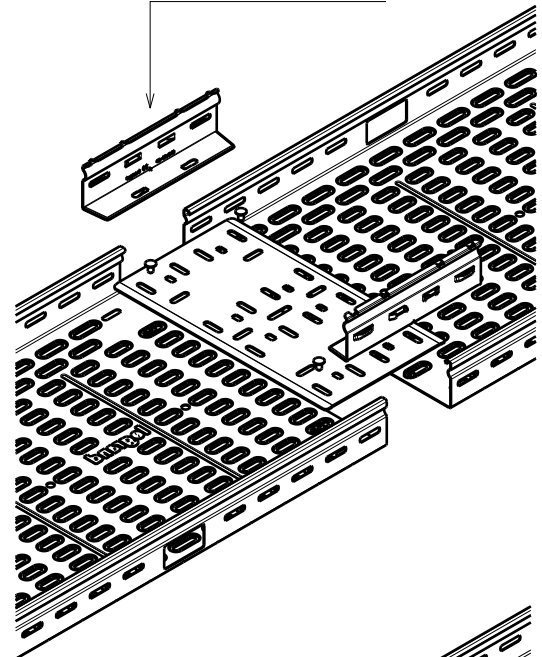

P31 - CHEMIN DE CÂBLES SYMÉTRIQUE (33X60)
P31 - SYMMETRICAL CABLE TRAYS (33x60)

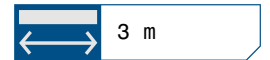
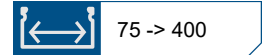
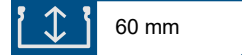

4. CHARGES ADMISSIBLES
LOADING GRAPH

H60 Symmetrical (30X60) - TEST TYPE 4 (IEC 61537)

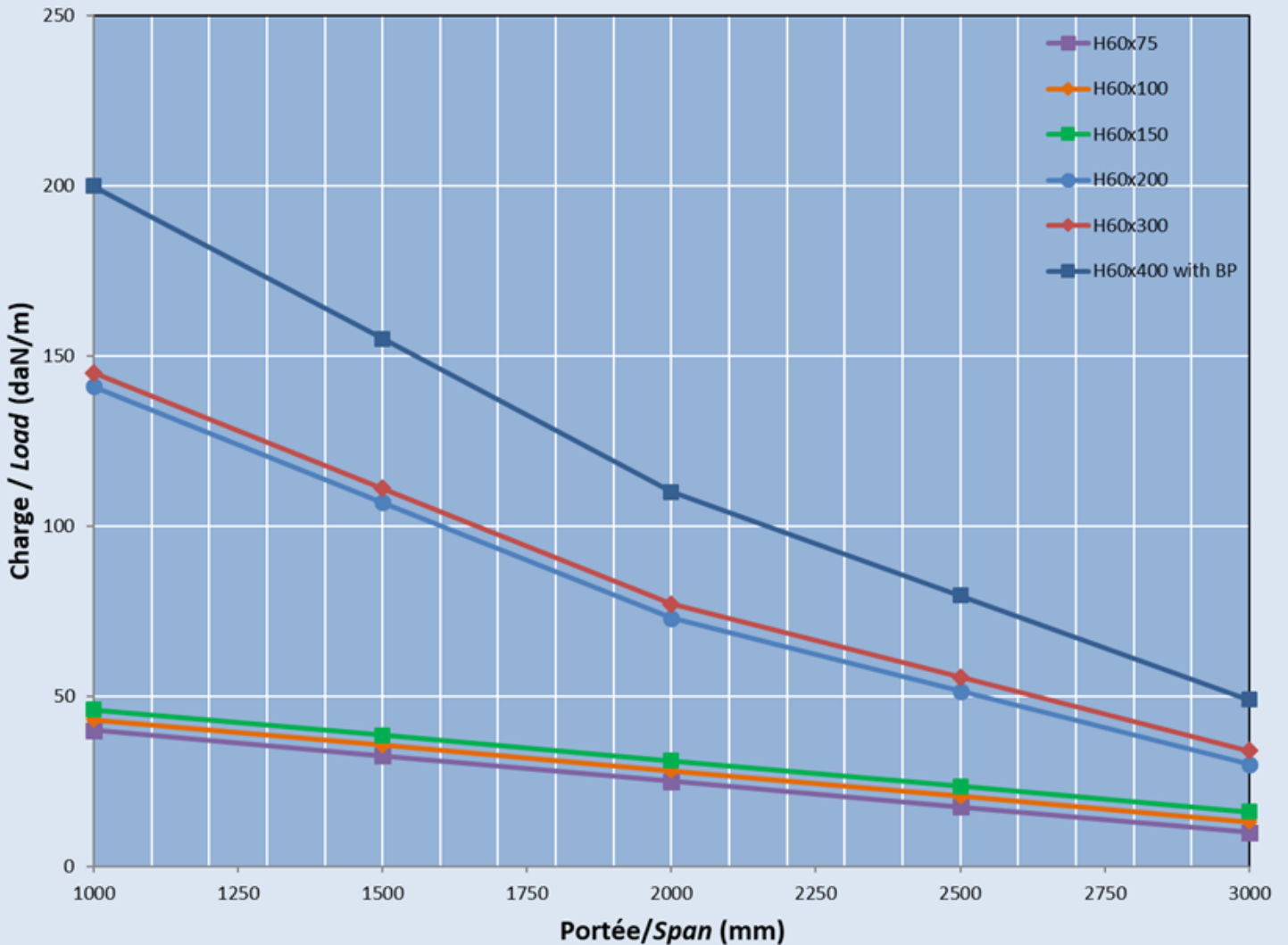

Eclisse fond pour largeurs de 400mm (voir page 5)
Bottom plate for width 400mm (see page 5)

Designation Description	Finition GS Coating PG
Eclisse fond 400 Bottom plate 400	481181