

Fixation universelle sur poutrelle -HFM
 Universal fixing on beam -HFM

CABLOFIL®

INNOVATORS IN CABLE MANAGEMENT

FT0219-7 02-20

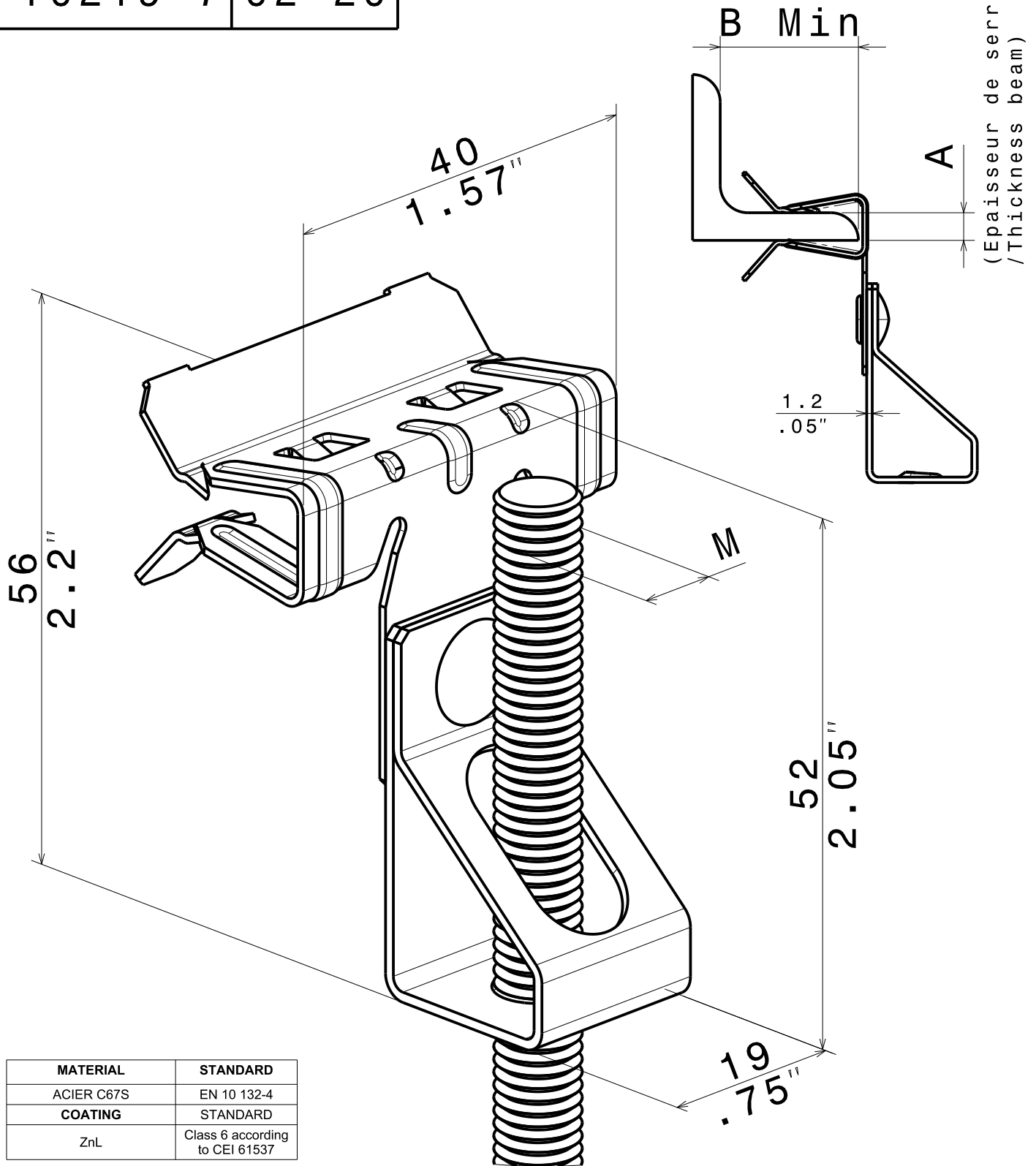

MATERIAL	STANDARD
ACIER C67S	EN 10 132-4
COATING	STANDARD
ZnL	Class 6 according to CEI 61537

REF	CODE	POIDS / WEIGHT		M	A		B		C	
		(Kg)	(lb)		(mm)	(inch)	(mm)	(inch)	(mm)	(inch)
HFM 8/4	559 817	0.020	0.009	M8	1.5-4	0.059-0.157	18	0.709	50	1.969
HFM 8/10	559 837	0.025	0.011	M8	4-10	0.157-0.394	25	0.984	55	2.165

Propriété exclusive de CABLOFIL, ne peut être ni copié, ni transmis à des tiers sans autorisation écrite.
 Exclusive property of CABLOFIL shouldn't be reproduced or transmitted to any people without written authorization