

Céliane™
Indicator light

Cat. No.: CM0276

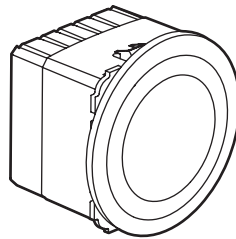

1. USE

LED signalling indicator light with two different lighting levels (lighting/ marking).

2. RANGE

Description	Cat. No.
Indicator light. Delivered with four colours (orange, green, blue, red), one label holder and a set of ten pictographs for marking.	CM0276

3. OVERALL DIMENSIONS (mm)

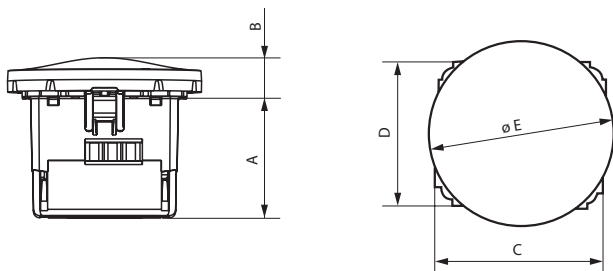

A	B	C	D	Ø E
32.7	10.9	45	45	53

4. FITTING

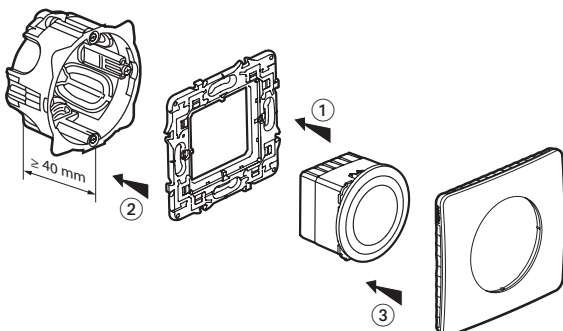

4. FITTING (continued)

Can be fitted with the full range of Céliane finishes.
 Vertical or horizontal multi-gang mounting.
 A pictograph or colour can be mounted once the protective glass has been removed.

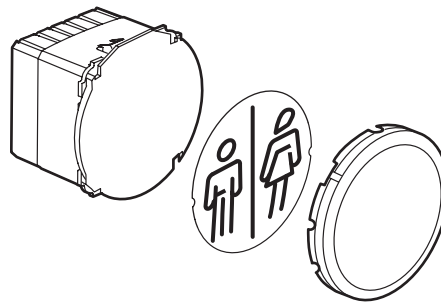

Bag labels for marking.

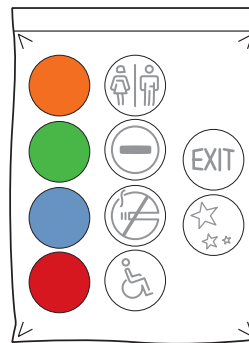

5. CONNECTION

Screw terminals.
 Capacity 2 x 1.5 mm² or 1 x 2.5 mm²
 Tool: flat screwdriver 3.5 mm
 or Posidriv No 1 or Philips No 1 or mixed size 0.
 Stripping length: 8 mm

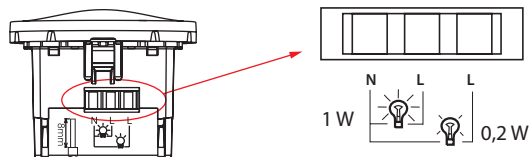

6. TECHNICAL CHARACTERISTICS

■ 6.1 Mechanical characteristics

Impact tests: IK 04

Penetration by solid/bodies liquids: IP 41

■ 6.2 Material characteristics

Base: Polycarbonate

Indicator light: Polycarbonate

■ 6.3 Electrical characteristics

Self-extinguishing: 650° C / 30 s for parts made of insulating materials.

Voltage: 230 V

Frequency: 50/60 Hz

Power:

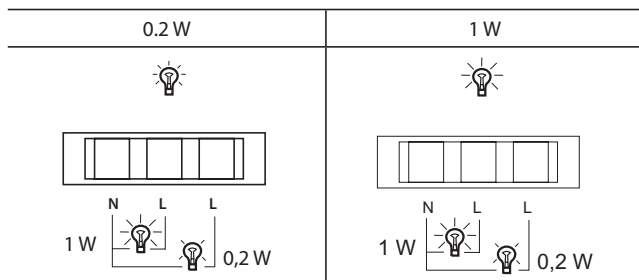

■ 6.4 Climatic characteristics

Storage temperature: - 10° C to + 70° C

Operating temperature: - 5° C to + 50° C

■ 6.5 Brightness levels

Brightness levels in candela per m²:

- in high brightness position: 1700 cd/m²

- in low brightness position: 350 cd/m²