

Incara™ On Desk French/Belgian, Schuko & BS Standards

Cat. no(s): 6 551 00AB to 02AB - 6 551 10AB to 25AB - 6 551 00BK to 02BK/10BK to 25BK - 6 551 00WH to 02WH/10WH to 25WH - 6 551 30AB to 41AB - 6 551 30BK to 41BK - 6 551 30WH to 41WH - 6 551 56AB to 59AB - 6 551 56BK to 59BK - 6 551 56 WH to 59WH - 6 551 99

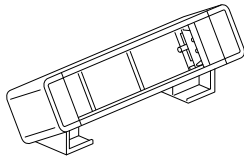

6 551 01

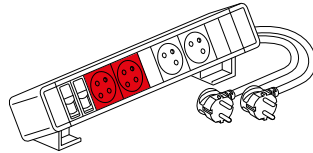

6 551 20

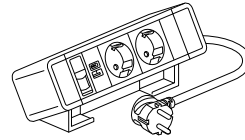

6 551 37

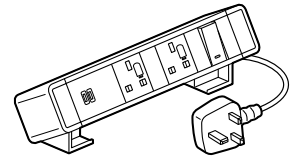

6 551 59

1. USE

Equipped or to be equipped, Incara™ On Desk provides flexibility and ease of use to mobile or sedentary workers. With its sleek design and small footprint, the On Desk fits in any furniture configuration and is easy to install, close to the user with no drilling required.

2. RANGE

■ 2.1 Incara™ On Desk offices modules empty to be equipped

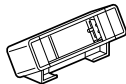
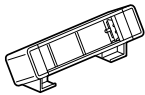
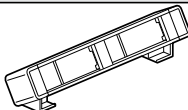
Cat. nos	Colors	Modules nr	Functions	Dimensions L x w x h (mm)
6 551 00WH	white	6		213,4 x 79,4 x 85,6
6 551 00BK	black			
6 551 00AB	alu/black			
6 551 01WH	white	8		258,5 x 79,4 x 85,6
6 551 01BK	black			
6 551 01AB	alu/black			
6 551 02WH	white	12		371 X 79,4 x 85,6
6 551 02BK	black			
6 551 02AB	alu/black			

Incara™ On Desk French/Belgian, Schuko & BS Standards

Cat. no(s): 6 551 00AB to 02AB - 6 551 10AB to 25AB - 6 551 00BK to 02BK/10BK to 25BK - 6 551 00WH to 02WH/10WH to 25WH - 6 551 30AB to 41AB - 6 551 30BK to 41BK - 6 551 30WH to 41WH - 6 551 56AB to 59AB - 6 551 56BK to 59BK - 6 551 56WH to 59WH - 6 551 99

2. RANGE (cont.)

2.2 French/Belgian standard pre-equipped Incara™ On Desk office modules to wire

Power socket connection on terminal block with cable retainer
RJ45 coupling (female/female)

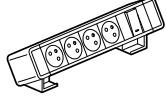
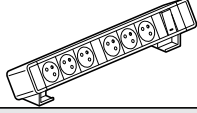
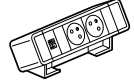
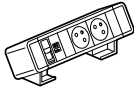
Cat. nos	Colors	Modules nr	Functions	Dimensions L x w x h (mm)
4 x 2P+E sockets & 1 illuminated switch				
6 551 24WH	white	8		303,5 x 79,4 x 85,6
6 x 2P+E sockets & 1 illuminated switch				
6 551 25WH	white	12		416 x 79,4 x 85,6
2 x 2P+E sockets & 1 x 15 W USB Type-A + Type-C charging module				
6 551 22WH	white	6		213,4 x 79,4 x 85,6
2 x 2P+E sockets & 1 x 15 W USB Type-A + Type-C charging module & 1 x RJ 45 cat. 6 FTP socket				
6 551 23WH	white	8		236 x 79,4 x 85,6

2.3 French/Belgian & Schuko standard pre-equipped Incara™ On Desk office modules equipped with power cord

Wired and equipped with a 2 m power cord and with a 2P+E plug (H05VVF, 3-core 1.5 mm²)

2.3.1 With power sockets

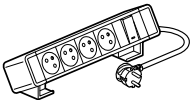
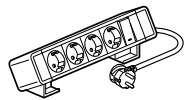
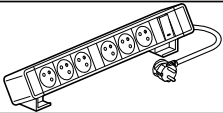
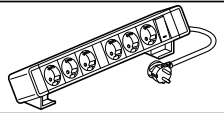
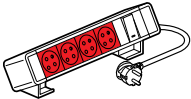
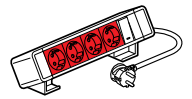
Modules nr	Colors	Standards					
		French/Belgian			Schuko		
		Cat. nos	Functions	Dimensions L x w x h (mm)	Cat. nos	Functions	Dimensions L x w x h (mm)
4 x 2P+E sockets & 1 x illuminated switch							
8	white	6 551 14WH		303,5 x 79,4 x 85,6	6 551 34WH		281 x 79,4 x 85,6
	black	6 551 14BK			6 551 34BK		
	alu/black	6 551 14AB			6 551 34AB		
6 x 2P+E sockets & 1 x illuminated switch							
12	white	6 551 18WH		416 x 79,4 x 85,6	6 551 38WH		393,5 x 79,4 x 85,6
	black	6 551 18BK			6 551 38BK		
	alu/black	6 551 18AB			6 551 38AB		
4 x 2P+E tamperproof sockets & 1 x illuminated switch							
8	white	6 551 19WH		303,5 x 79,4 x 85,6	6 551 39WH		281 x 79,4 x 85,6
	black	6 551 19BK			6 551 39BK		
	alu/black	6 551 19AB			6 551 39AB		

Incara™ On Desk French/Belgian, Schuko & BS Standards

Cat. no(s): 6 551 00AB to 02AB - 6 551 10AB to 25AB - 6 551 00BK to 02BK/10BK to 25BK - 6 551 00WH to 02WH/10WH to 25WH - 6 551 30AB to 41AB - 6 551 30BK to 41BK - 6 551 30WH to 41WH - 6 551 56AB to 59AB - 6 551 56BK to 59BK - 6 551 56WH to 59WH - 6 551 99

2. RANGE (cont.)

2.3.2 With power & data sockets & USB charging module - HDMI & RJ 45 (female/female)

Modules nr	Colors	Standards						
		French/Belgian			Schuko			
		Cat. nos	Functions	Dimensions L x w x h (mm)	Cat. nos	Functions	Dimensions L x w x h (mm)	
2 x 2P+E sockets, 1 x 15 W USB Type-A + Type-C charging module & 1 RJ 45 cat.6 FTP socket								
8 F/B	6 SCH	white	6 551 17WH		236 x 79,4 x 85,6	6 551 37WH		213,4 x 79,4 x 85,6
		black	6 551 17BK			6 551 37BK		
		alu/black	6 551 17AB			6 551 37AB		
3 x 2P+E sockets, 1 x 15W USB Type-A + Type-C & 1 x RJ 45 cat. 6 FTP socket & 1 HDMI 2.0 socket								
12		white	6 551 21WH		303,5 x 79,4 x 85,6	6 551 41WH		281 x 79,4 x 85,6
		black	6 551 21BK			6 551 41BK		
		alu/black	6 551 21AB			6 551 41AB		
2 x 2P+E sockets, 2 x 2P+E tamperproof sockets & 2 x RJ 45 cat. 6 FTP sockets								
12		white	6 551 20WH		348,8 x 79,4 x 85,6	6 551 40WH		348,8 x 79,4 x 85,6
		black	6 551 20BK			6 551 40BK		
		alu/black	6 551 20AB			6 551 40AB		

2.3.3 With power sockets & USB charging module

Modules nr	Colors	Standards						
		French/Belgian			Schuko			
		Cat. nos	Functions	Dimensions L x w x h (mm)	Cat. nos	Functions	Dimensions L x w x h (mm)	
2 x 2P+E sockets & 1 x 15 W USB Type-A + Type-C charging module								
6		white	6 551 10WH		213,4 x 79,4 x 85,6	6 551 30WH		190,8 x 79,4 x 85,6
		black	6 551 10BK			6 551 30BK		
		alu/black	6 551 10AB			6 551 30AB		
3 x 2P+E sockets & 1 x 15W USB Type-A + Type-C charging module								
8		white	6 551 11WH		258,5 x 79,4 x 85,6	6 551 31WH		236 x 79,4 x 85,6
		black	6 551 11BK			6 551 31BK		
		alu/black	6 551 11AB			6 551 31AB		
2 x 2P+E sockets & 1 x 15W USB Type-C + Type-C charging module								
6		white	6 551 12WH		213,4 x 79,4 x 85,6	6 551 32WH		190,8 x 79,4 x 85,6
		black	6 551 12BK			6 551 32BK		
		alu/black	6 551 12AB			6 551 32AB		
3 x 2P+E sockets & 1 x 15 W USB Type-C + Type-C charging module								
8		white	6 551 13WH		258,5 x 79,4 x 85,6	6 551 33WH		236 x 79,4 x 85,6
		black	6 551 13BK			6 551 33BK		
		alu/black	6 551 13AB			6 551 33AB		
2 x 2P+E sockets & 1 x 45W Power Delivery USB Type-C charging module								
8 F/B	6 SCH	white	6 551 16WH		236 x 79,4 x 85,6	6 551 36WH		213,4 x 79,4 x 85,6
		black	6 551 16BK			6 551 36BK		
		alu/black	6 551 16AB			6 551 36AB		
2 x 2P+E & 1 x 63W Power Delivery USB Type-C + Type-C charging module								
8		white	6 551 15WH		258,5 x 79,4 x 85,6	6 551 35WH		236 x 79,4 x 85,6
		black	6 551 15BK			6 551 35BK		
		alu/black	6 551 15AB			6 551 35AB		

Incara™ On Desk

French/Belgian, Schuko & BS Standards

Cat. no(s): 6 551 00AB to 02AB - 6 551 10AB to 25AB - 6 551 00BK to 02BK/10BK to 25BK - 6 551 00WH to 02WH/10WH to 25WH - 6 551 30AB to 41AB - 6 551 30BK to 41BK - 6 551 30WH to 41WH - 6 551 56AB to 59AB - 6 551 56BK to 59BK - 6 551 56WH to 59WH - 6 551 99

2. RANGE (cont.)

■ 2.4 BS standard pre-equipped Incara™ On Desk office modules equipped with power cord

Wired and equipped with a 2 m power cord (H05VVF, 3-core 1.5 mm²) and with a BS 1363-2 2P+E plug equipped with 5A fused sockets

With power sockets, USB charging module and 1 illuminated switch

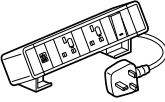
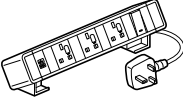
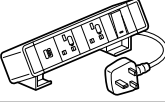
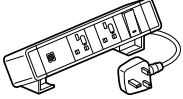
Modules nr	Colors	Standard		
		BS		
		Cat. nos	Functions	Dimensions L x w x h (mm)
2 x 2P+E sockets & 1 x 15W USB Type-A + Type-C charging module				
10	white	6 551 56WH		303,5 x 79,4 x 85,6
	black	6 551 56BK		
	alu/black	6 551 56AB		
3 x 2P+E sockets & 1 x 15 W USB Type-A + Type-C charging module				
12	white	6 551 57WH		371 x 79,4 x 85,6
	black	6 551 57BK		
	alu/black	6 551 57AB		
2 x 2P+E sockets & 1 x 45W Power Delivery USB Type-C charging module				
10	white	6 551 58WH		303,5 x 79,4 x 85,6
	black	6 551 58BK		
	alu/black	6 551 58AB		
2 x 2P+E & 1 x 63W Power Delivery USB Type-C + Type-C charging module				
10	white	6 551 59WH		326 x 79,4 x 85,6
	black	6 551 59BK		
	alu/black	6 551 59AB		

Incara™ On Desk French/Belgian, Schuko & BS Standards

Cat. no(s): 6 551 00AB to 02AB - 6 551 10AB to 25AB - 6 551 00BK to 02BK/10BK to 25BK - 6 551 00WH to 02WH/10WH to 25WH - 6 551 30AB to 41AB - 6 551 30BK to 41BK - 6 551 30WH to 41WH - 6 551 56AB to 59AB - 6 551 56BK to 59BK - 6 551 56WH to 59WH - 6 551 99

3. INSTALLATION

■ 3.1 Installation on the table top

3.1.1 Adhesive fastening using the double-sided adhesives supplied

For 6 or less modules outlet units

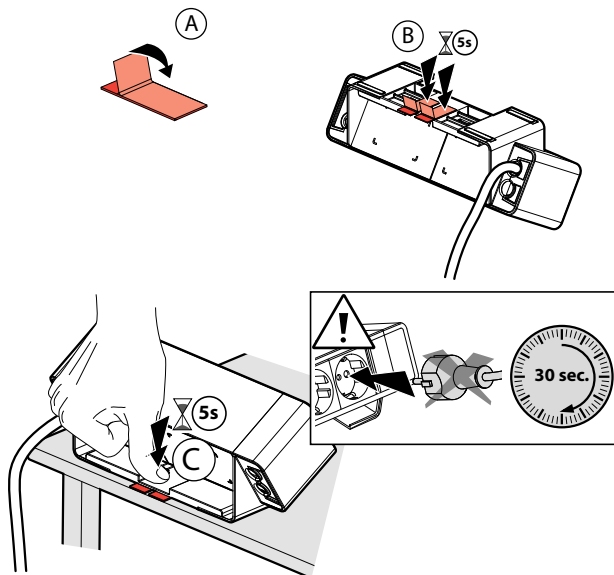

For 8 or more modules outlet units

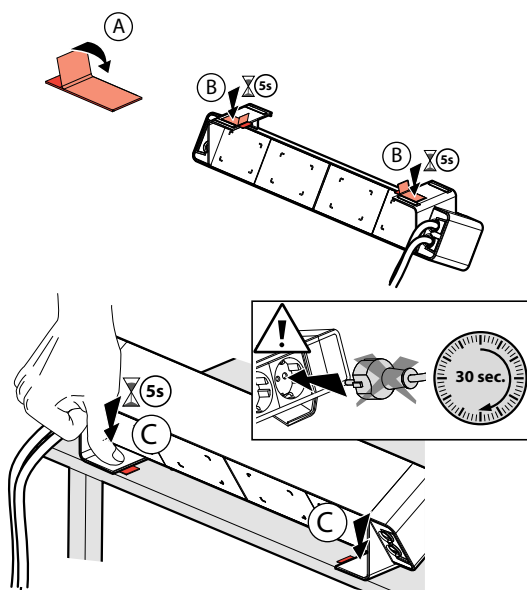

3. INSTALLATION (cont.)

3.1.2 installation with the fixing accessory cat. no 6 551 99

U-shaped body:

Painted black steel plate

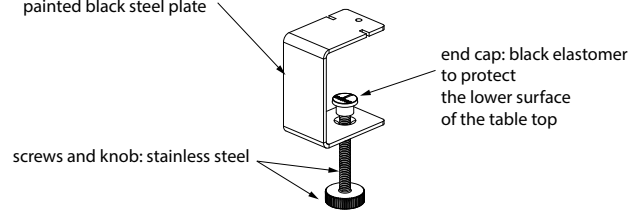

This accessory allows fixing on a desk with 6 to 40 mm depth.

For 6 or less modules outlet unit, necessary to use only 1 accessory (cat. no 6 551 99) per Incara™ On Desk office module

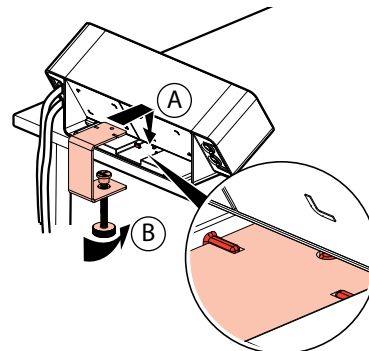

This accessory has to be fixed on the junction element of office module legs thus preventing any risk of damage to the furniture.

For 8 or more modules outlet unit, necessary to use 2 accessories (cat. no 6 551 99) per Incara™ On Desk office module

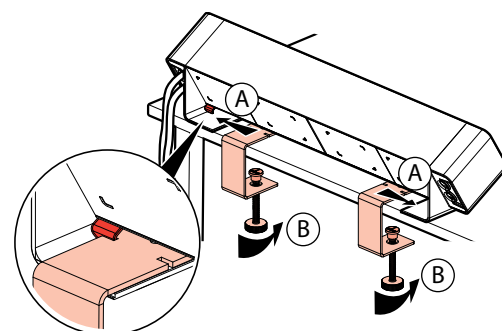

This accessory has to be fixed on the office module legs thus preventing any risk of damage to the furniture.

■ 3.2 Removing from the work surface

The double-sided adhesive can be removed without damaging the furniture, simply by pulling the tab protruding from the leg.

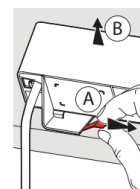

Incara™ On Desk French/Belgian, Schuko & BS Standards

Cat. no(s): 6 551 00AB to 02AB - 6 551 10AB to 25AB - 6 551 00BK to 02BK/10BK to 25BK - 6 551 00WH to 02WH/10WH to 25WH - 6 551 30AB to 41AB - 6 551 30BK to 41BK - 6 551 30WH to 41WH - 6 551 56AB to 59AB - 6 551 56BK to 59BK - 6 551 56WH to 59WH - 6 551 99

4. GENERAL CHARACTERISTICS

4.1 Mechanical characteristics

Resistance to Impact: IK 07
Degree of protection provided by enclosures: IP 30

4.2 Material characteristics

Painted aluminium bars
ABS end cap
ABS cable clamp
Polypropylene screw terminal connection strip
PC illuminated switch

4.3 Electrical characteristics

4.3.1 2 P+E sockets characteristics

Supply voltage: 16A-250V ~ 3680W Max - 230V~
Frequency: 50/60 Hz
Rated current for French & Schuko standards = 16A
Max power for BS standards =
- 2 sockets with wire with 2P+E plug : 10A - 2300W
- 3 sockets with wire with 2P+E plug : 13A - 2990W

4.3.2 USB charger characteristics

Refer to technical data sheets of cat. nos USB chargers

15 W Type-A + Type-C	0 776 70L	white
	0 776 72L	matt black
15 W Type-C + Type-C	0 776 80L	white
	0 776 82L	matt black
30 W Type C + Type C	0 776 31L	white
	0 776 33L	matt black
45 W Type- C	0 776 55L	white
	0 776 57L	matt black
63 W Type-C + Type-C	0 776 73L	white
	0 776 75L	matt black

4.3.3 RJ 45 Coupler characteristics

4.3.3.1 Performance of link

Standard performance at 20°C

Following chart indicates maximal distances according to several configurations

CP Cord (C)	Maximum CP link (B)	TR Cord(s) (A)	Work Area Cord (D)	Total Channel
8 m	74 m	5 m	5 m	92 m
15 m	63 m			88 m
20 m	56 m			86 m

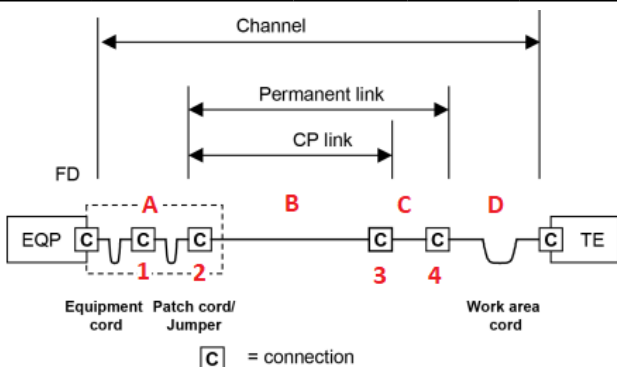

4. GENERAL CHARACTERISTICS (cont.)

- Optional replication panel used only in specific 4-connector channels
- Panel
- Outlet (considered as a consolidation point)
- Incara Product (considered as an outlet in a 3-connector permanent link)

4.3.3.2 POE compliance

PoE++ type 1, 2, 3 and 4 according to 802.3 standard.
For more informations about performance with POE please refer to Legrand documentation (Legrand POE Guide)

4.3.4 Cords characteristics:

If delivered with cord :
Cable type : power 2 meters HO5 VVF 3G 1.5 mm²
Plug type : 2P+E black male angled plug

If not delivered with cord :
Possibility to connect with :
HO5 VVF 3G 1.5 mm² or 3G 2.5 mm² (2 outputs max)

4.3.5 Audio/Video (HDMI coupler) characteristics

These values are subject to installation in accordance with good engineering practice and connection in compliance with current standards. Additional accessories and cords must comply with the same criteria.

4.3.5.1 HDMI 1.4

Maximum resolution (pixels) : 1080p

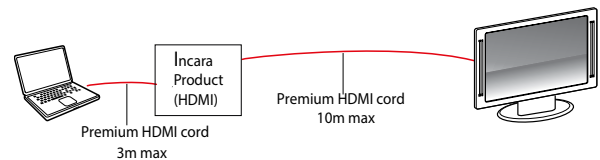

4.3.5.2 HDMI 2.0

Maximum resolution (pixels) : 2160p
16/9 format: 2160 p, 60Hz, RGB
21/9 format: 3840 x 2160p, 60Hz, RGB

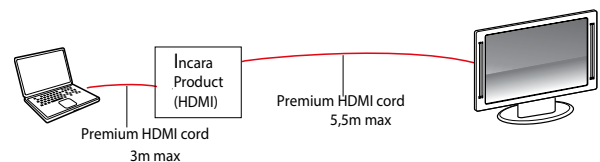

4.4 Climate characteristics

Operating temperature: from -5°C to +35°C
Storage temperature: from -10°C to +70°C

5. CLEANING

Superficial cleaning with a soft cloth. Do not use abrasive products or detergents.

Caution: Always test before using other special cleaning products

6. STANDARDS & APPROVALS

Compliant to:

- NF C61-314
- IEC 60884-1 & IEC 60884-3-1
- BS 5733

USB Charger compliant to: IEC 62368-1