

Mosaic™

Dimmer without neutral 125 VA Dimmer with neutral 150 VA

Cat. No(s): 0 488 70LA - 0 784 07A - 0 791 07LA - 0 792 07A
0 784 08A - 0 791 08LA - 0 792 08A

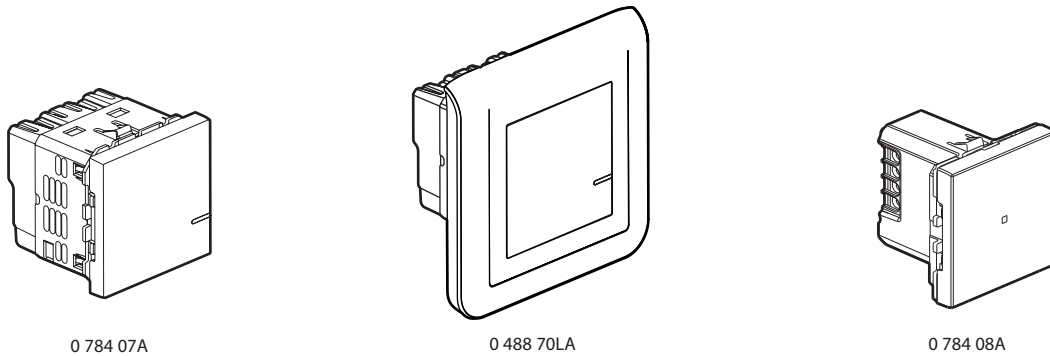

0 784 07A

0 488 70LA

0 784 08A

1. USE

These products allow the control and variation of all types of lamps.
Can be associated with one or several push-buttons without neon, each push-button then allowing the on/off/dimming functions.
Gradually turn the light on and off.
Lights come on again at the same lighting level as before they were last switched off.

Used:

- in luminous mode (indicator)
- in status memory mode
- in leading mode, trailing depending on the load (see load tables on page 2).

Installed in a box at least 40 mm deep.
Fixing with screws.

2. RANGE

0 784 07A 0 791 07LA 0 792 07A	○ White ● Matte black ● Aluminium	2-wire dimmer without neutral To be equipped with Batibox support and plate
0 488 70LA	○ White	2-wire dimmer without neutral Complete delivered with Batibox support and plate
0 784 08A 0 791 08LA 0 792 08A	○ White ● Matte black ● Aluminium	3-wire dimmer with neutral To be equipped with Batibox support and plate

3. DIMENSIONS (mm)

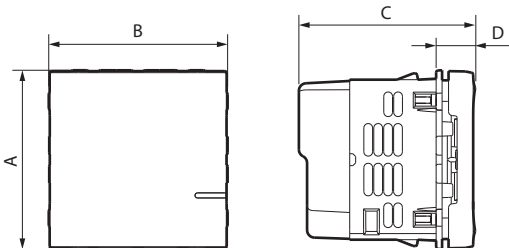

Cat. Nos	A	B	C	D
0 784 07A - 0 791 07LA - 0 792 07A	45	45	44.5	8
0 488 70LA	82	82	44.5	8
0 784 08A - 0 791 08LA - 0 792 08A	45	45	44.5	8

4. CONNECTION

Type of terminals: with screws
Terminal capacity: 2 x 1.5 mm² or 1 x 2.5 mm²
Stripping length: 8 mm (without neutral)
7 mm (with neutral)
Screwdriver: 3 mm flat

5. OPERATION

■ 5.1 2-wire dimmer without neutral

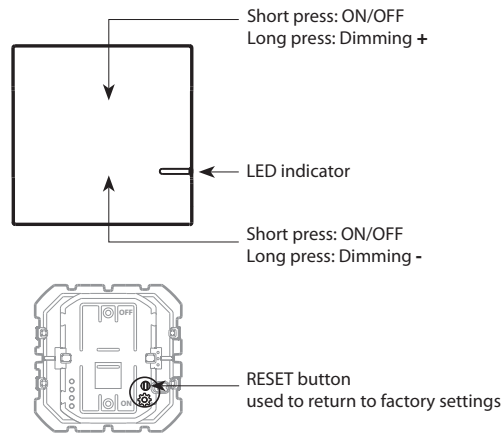

■ 5.2 3-wire dimmer with neutral

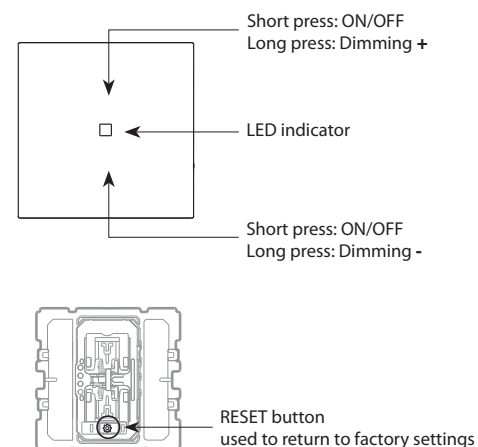

6. TECHNICAL CHARACTERISTICS**■ 6.1 Mechanical characteristics**

Protection against impacts: IK 04

Protection against solid bodies and liquids: IP 20

■ 6.2 Material characteristics

Mechanism casing: PC

Support: PA 6.6 + Galfan steel

Rocker: PC

Colour: White RAL 9003

Painted matt black RAL 9017, satin finish

Painted aluminium

Plate (complete product): White ABS RAL 9003, polyglass appearance

Halogen-free

UV-resistant

Self-extinguishing:

850°C/30 s for insulating components holding live parts in place.

650°C/30 s for other insulating components.

■ 6.3 Climate characteristics

Usage temperature: +5°C to +35°C

Storage temperature: 0°C to +45°C









■ 6.4 Electrical characteristics - 2-wire without neutral

Voltage: 110-230 V~

Power: 125 W

Frequency: 50/60 Hz

Standby consumption: 0.3 W

			Dimmable LED 		
					
230 V~	Maxi.	125 W	(*)125 VA	125 VA	125 VA
	Min.	3 W	(*)3 VA	3 VA	5 VA
110 V~	Max.	75 W	(*)75 VA	75 VA	75 VA
	Min.	3 W	(*)3 VA	3 VA	3 VA

(*) For comfortable lighting, we recommend using bulbs of the same type and make.
Max. 10 bulbs.

Do not mix different load types on the same product.

Compatibility with ferromagnetic type loads is only possible in "Leading" mode (see product manual 0 784 07A).

Caution: Only works with variable-intensity bulbs.

In case of poor load operation, it may be necessary to use the active compensator Ref. 0 401 49.









6. TECHNICAL CHARACTERISTICS (continued)**■ 6.5 Electrical characteristics 3-wire with neutral**

Voltage: 110-230 V~

Power: 150 W

Frequency: 50/60 Hz

Standby consumption: 0.7 W

			Dimmable LED 		
					
230 V~	Maxi.	150 W	(*)150 VA	150 VA	150 VA
110 V~	Maxi.	75 W	(*)75 VA	75 VA	75 VA

(*) For comfortable lighting, we recommend using bulbs of the same type and make.
Max. 15 bulbs.

Do not mix different load types on the same product.

Compatibility with ferromagnetic type loads is only possible in "Leading" mode (see product data sheet 0 784 08A).

Caution: Only works with variable-intensity bulbs.**7. CARE**

Clean the surface with a cloth.

Resistance to the following products:

Hexane, methylated spirit, soapy water, diluted ammonia, pure bleach diluted to 10%, window-cleaning products, pre-impregnated wipes.

Caution: Always test before using special cleaning products.**8. STANDARDS AND APPROVALS**

Compliant with installation and manufacturing standards.

See e-catalogue.