

## Valena™ Allure Double connected switch with neutral

Cat. No(s): 7 525 88 - 7 526 88 - 7 527 88  
7 528 88 - 7 529 88

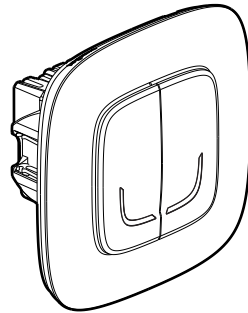

### 1. USE

Double switch with neutral for 2 ON/OFF light functions.  
Can be used as a two-way switch or to control a lighting group.  
Compatible all loads 250 W max. per output.  
Easy to install in place of a standard switch in a box 40 mm deep (min.).  
Claws and/or screws fixing.

### 2. RANGE

Product for use in conjunction with the starter pack.  
With LED indicator (configuration) and RESET button (hidden) used to return to factory settings.  
Supplied complete with claws and site protection covers.

White	Ivory	Alu	Black	Pearl
7 525 88	7 526 88	7 527 88	7 528 88	7 529 88

### 3. DIMENSIONS (mm)

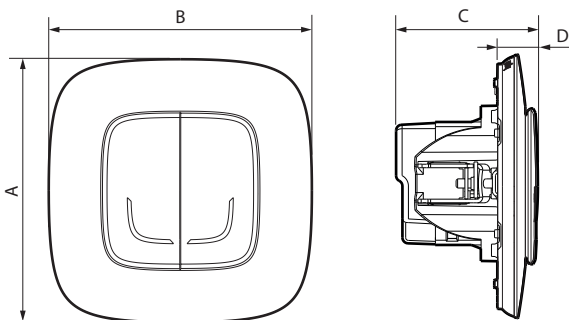

A	B	C	D
86	86	44.5	11,5

### 4. CONNECTION

Type of terminals: with screws  
Terminal capacity: 2 x 1.5 mm<sup>2</sup> or 1 x 2.5 mm<sup>2</sup>  
Stripping length: 8 mm  
Flat screwdriver: 3 mm

### 5. OPERATION

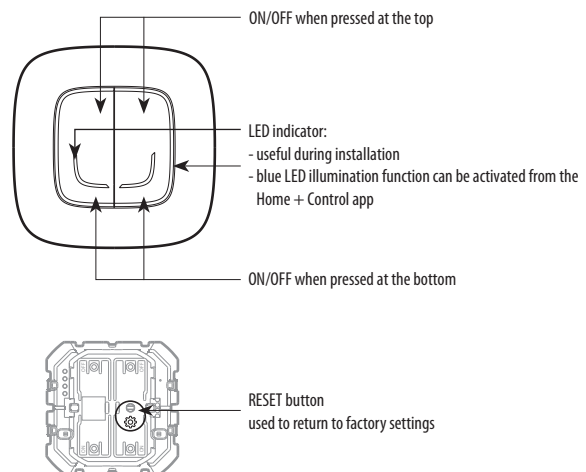

### 6. TECHNICAL CHARACTERISTICS

#### ■ 6.1 Mechanical characteristics

Protection against impacts: IK 04  
Protection against solid bodies/liquids: IP 40

#### ■ 6.2 Material characteristics

Plate: ABS  
Sub-plate: PC  
Rocker plate: ABS  
Mechanism casing: PC  
Support: PC grey RAL 7016 + metal  
Claws: Steel

Halogen-free  
UV-resistant

#### Self-extinguishing:

850°C/30 s for insulating components holding live parts in place.  
650°C/30 s for other insulating components.

#### ■ 6.3 Climate characteristics

Usage temperature: + 5°C to + 45°C  
Storage temperature: 0°C to + 45°C

**6. TECHNICAL CHARACTERISTICS** (continued)

■ **6.4 Electrical characteristics**











Voltage: 110-240 V~

Power: 250 W max. per output

Current: 1.1 A max. per output

Frequency: 50/60 Hz

Load table:

			LED 			(*) 
						
240 V~	Maxi.	250 W	50 W	50 W	125 VA	125 VA
110 V~	Maxi.	125 W	25 W	25 W	65 VA	65 VA

(\*) Use only with transformers designed to work with electronic switches.

Take account of transformer losses when calculating power.

Transformers must be loaded at more than 60% of their power.

**Zigbee technology** 2.4 GHz to 2.4835 GHz

Power level: < 100 mW

Range: 200 m of unobstructed space

10 m between products indoors

**7. CARE**

Clean the surface with a cloth.

Do not use acetone, tar-removing cleaning agents or trichloroethylene.

Resistant to the following products:

Hexane (EN 60669-1), methylated spirit, soapy water, diluted ammonia, pure bleach diluted to 10%, window-cleaning products, pre-impregnated wipes.

**Caution:** Always test before using special cleaning products.

The plates must not be painted.

**8. STANDARDS AND APPROVALS**

Compliant with installation and manufacturing standards.

See e-catalogue.

The undersigned, LEGRAND, declares that the radio-electric equipment type (7 525 88 - 7 526 88 - 7 527 88 - 7 528 88 - 7 529 88) complies with directive 2014/53/EU.

The full text of the EU declaration of conformity is available on the following website: [www.legrandoc.com](http://www.legrandoc.com)