

Mosaic™ with Netatmo Double connected switch with neutral

Cat. No(s): 0 777 02LA

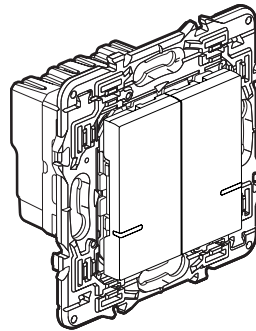

1. USE

Double switch with neutral for 2 ON/OFF light functions.
 Can be used as a two-way switch or to control a lighting group.
 Compatible all loads 250 W max. per output.
 Easy to install in place of a standard switch in a box 40 mm deep (min.).
 Claws and/or screws fixing.

2. RANGE

Description	White
Product for use in conjunction with the starter pack. With LED indicator (configuration) and RESET button (hidden) used to return to factory settings. Supplied with site protection cover. To be equipped with cover plate.	0 777 02LA

3. DIMENSIONS (mm)

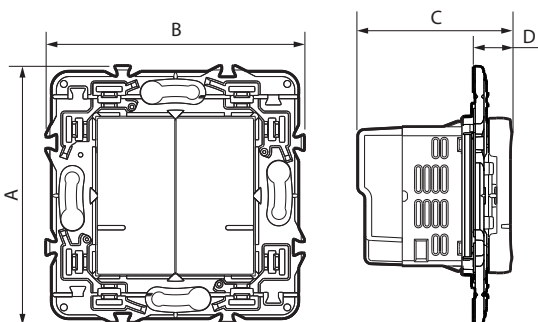

A	B	C	D
74	74	43.5	11

4. CONNECTION

Type of terminals: with screws
 Terminal capacity: 2 x 1.5 mm² or 1 x 2.5 mm²
 Stripping length: 8 mm
 Flat screwdriver: 3 mm

5. OPERATION

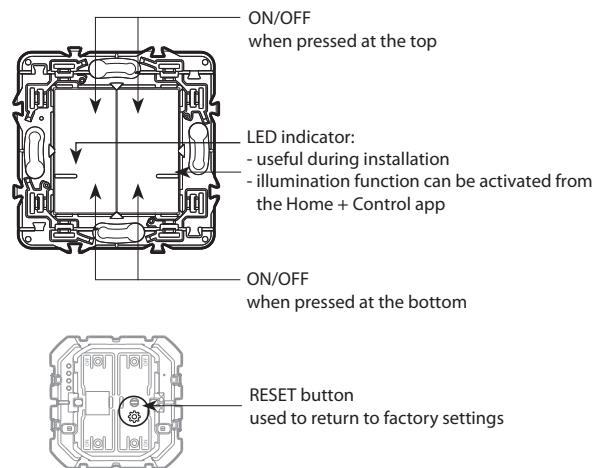

6. TECHNICAL CHARACTERISTICS

■ 6.1 Mechanical characteristics

Protection against impacts: IK 04
 Protection against solid bodies/liquids: IP 40

■ 6.2 Material characteristics

Rockers: PC
 Colour: White RAL 9003
 Mechanism casing: PC
 Grid: 6.6 PA + Galfan steel
 Claws: Steel

Halogen-free
 UV-resistant

Self-extinguishing:

850°C/30 s for insulating components holding live parts in place.
 650°C/30 s for other insulating components.

■ 6.3 Climate characteristics

Usage temperature: + 5°C to + 45°C
 Storage temperature: 0°C to + 45°C

6. TECHNICAL CHARACTERISTICS *(continued)*

■ 6.4 Electrical characteristics











Voltage: 110-240 V~

Power: 250 W max. per output

Current: 1.1 A max. per output

Frequency: 50/60 Hz

Load table:

			LED 			
						
240 V~	Maxi.	250 W	50 W	50 W	125 VA	125 VA
110 V~	Maxi.	125 W	25 W	25 W	65 VA	65 VA

(*) Use only with transformers designed to work with electronic switches.

Take account of transformer losses when calculating power.

Transformers must be loaded at more than 60% of their power.

Zigbee technology 2.4 GHz to 2.4835 GHz

Power level: < 100 mW

Range: 200 m of unobstructed space

10 m between products indoors

7. CARE

Clean the surface with a cloth.

Do not use acetone, tar-removing cleaning agents or trichloroethylene.

Resistant to the following products:

Hexane (EN 60669-1), methylated spirit, soapy water, diluted ammonia, pure bleach diluted to 10%, window-cleaning products, pre-impregnated wipes.

Caution: Always test before using special cleaning products.

8. STANDARDS AND APPROVALS

Compliant with installation and manufacturing standards.

See e-catalogue.

The undersigned, LEGRAND, declares that the radio-electric equipment type (0 777 02LA) complies with directive 2014/53/EU.

The full text of the EU declaration of conformity is available on the following website: www.legrandoc.com