

ATS

Automatic transfer switches

3 sources



CONTENTS

1. USE	1
2. RANGE	1
3. DIMENSIONS	1
4. ELECTRICAL AND MECHANICAL CHARACTERISTICS	1
5. CONFORMITY	4
6. EQUIPMENTS AND ACCESSORIES	4
7. SYNOPTICS	8
8. SOURCE PRIORITIES	8
9. OPEN OR CLOSED TRANSITION	9

PAGES

1. USE

ATS automation transfer switches can control power supply inversion between three sources, manage generator start/stop, control single phase, two-phase and three-phase networks, control phase-phase and phase-neutral voltages (managing till 5 devices).

2. RANGE

Reference	Management
4 226 84	3 sources / 5 breakers advanced managing

3. DIMENSIONS

Overall dimensions (mm)

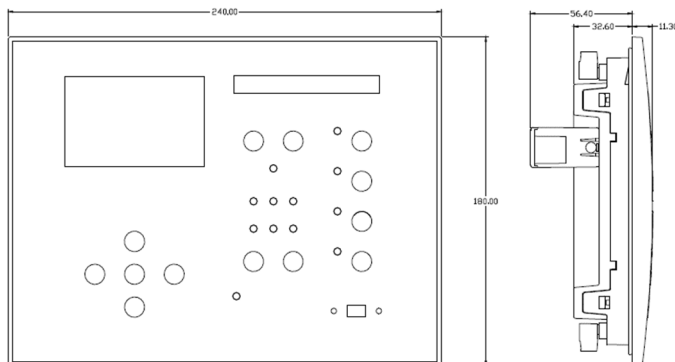

Panel cutout (mm)

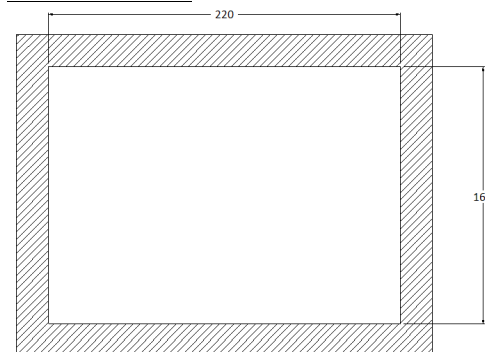

4. ELECTRICAL AND MECHANICAL CHARACTERISTICS

		4 226 84
AC power supply	Rated voltage U_e	100 - 240 V AC 111 - 250 V DC
	Frequency	45 - 66 Hz
	Power consumption/dissipation	100 V AC: 10 VA, 5.3 W 240 V AC: 12.5VA, 5.5W
DC power supply	Battery rated voltage (*)	12 - 48 V DC
	Maximum current consumption (*)	510mA at 12 V DC 260mA at 24 V DC 135mA at 48 V DC
	Maximum power consumption/dissipation (*)	6.5W
Line 1 and Line 2 voltage inputs	Maximum rated voltage U_n	600 V AC L-L (346 V AC L-N)
	Measuring range	50...720V L-L (415VAC L-N)
	Frequency range	45 ÷ 66 Hz – 360 ÷ 440 Hz
	Measuring method	True RMS
	Measuring input impedance	> 0.55MΩ L - N > 1,10MΩ L - L
Wiring mode	three-phase with or without neutral or balanced three-phase system	
Measuring accuracy	±0.25% f.s. ±1digit	
AC Supply Insulation voltage	Rated insulation voltage U_i	250 V AC
	Rated impulse withstand voltage U_{imp}	7.3 kV
	Power frequency withstand voltage	3 kV
Line 1 and Line 2 voltage inputs insulation voltage	Rated insulation voltage U_i	600 V AC
	Rated impulse withstand voltage U_{imp}	9.8 kV
	Power frequency withstand voltage	5.2 kV
Ambient operating conditions	Operating temperature	-30°C ÷ +70 °C
	Storage temperature	-30°C ÷ +80°C
	Measurement category	III
Connections	Terminal type	Plug-in / removable
	Cable cross section (min... max)	0.2 ÷ 2.5 mm ² (24 ÷ 12 AWG)
	Tightening torque	0.56 Nm (5 lbin)
Housing	Degree of protection	IP65 on front; IP20 terminals
	Weight	680 g
Modbus onboard port default configuration	Node address	1
	Speed	19200
	Data format	8 bit - EVEN
	Stop bits	1
	Protocol	RTU

Inputs and outputs

Digital inputs	
Input type	Negative
Current input	≤ 8mA
Input Low Voltage	≤ 2.2V
Input High Voltage	≥ 3.4V
Input delay	≥ 50ms

ATS

Automatic transfer switches

3 sources

Reference(s): 4 226 84

4. ELECTRICAL AND MECHANICAL CHARACTERISTICS (NEXT)

	Outputs	
	OUT1 - OUT3 - OUT5	OUT2 - OUT4 - OUT6
Contact type	3 x 1 NO	3 x 1 NO
Rated current	AC1 - 12A 250 V AC AC15 - 1.5A 250 V AC	AC1 - 8A 250 V AC AC15 - 1.5A 250 V AC
Max rated voltage	300 V AC	300 V AC
Mechanical endurance	10 ⁷ cycles	10 ⁷ cycles
Electrical endurance	10 ⁵ cycles	10 ⁵ cycles
Max current at common contact	12 A	12 A
Rated insulation voltage	U _i 250 V AC	U _i 250 V AC
Rated impulse withstand voltage	U _{imp} 7.3 kV	U _{imp} 7.3 kV
Power frequency withstand voltage	3 kV	3 kV

	OUT7 - OUT9 - OUT10 - OUT11
Contact type	1 changeover
Rated current	AC1 - 8A 250 V AC DC1 - 8A 30 V DC AC15 - 1.5A 250 V AC
Max rated voltage	300 V AC
Mechanical endurance	10 ⁷ cycles
Electrical endurance	10 ⁵ cycles
Rated insulation voltage	U _i 250 V AC
Rated impulse withstand voltage	U _{imp} 7.3 kV
Power frequency withstand voltage	3 kV

	OUT8
Contact type	1 static
Rated voltage	10-30 V DC
Max current	50 mA
Power frequency withstand voltage	1 kV

4.1 MONITORED PARAMETERS

Value	Parameter	Limits
Voltage	Value	MIN
		MAX
	Delay	MIN
		MAX
Threshold	MIN	
	MAX	
Line presence delay	without recovery line available	-
	with recovery line available	-
Phase failure	Threshold	-
	Delay	-
Asymmetry	Limit	MAX
	Delay	MAX
Frequency	Limit	MIN
		MAX
	Delay	MIN
		MAX

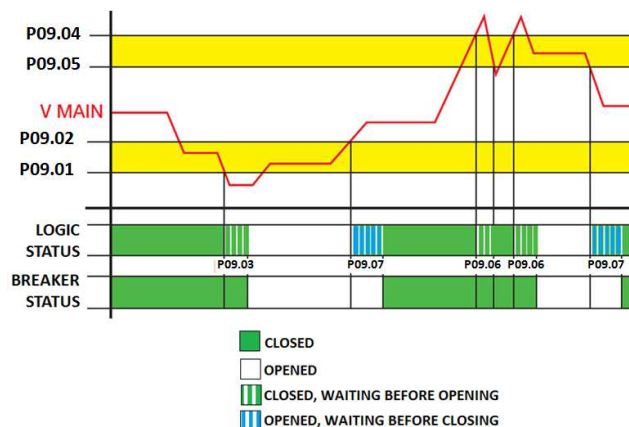

Example of variation of the main line voltage within the minimum and maximum thresholds and relative hysteresis, with indication of the presence / absence delay times. The example considers the secondary line voltage absent with its circuit breaker open, hence the changeover times are not shown. The BREAKER STATUS bar represents the required status of the main line switch, while the LOGIC STATUS bar represents actual logic status of line controller.

Px.y identify values to set for ATS (see instruction manual for details) and they correspond to the ones listed into table above on line "Voltage".

4.2 MAIN FEATURES

	4 226 84
Input	12 digital programmables
Output	11 relay programmables
Expandibility	Yes (3 slots)
ModBus Communication	Yes, with RS485 embedded
Event Log	Yes, 250 events

4.3 PLC MODE

It's possible to use Legrand *Automatic Control Unit Configurator* (see chap. 6.4) to set a ladder program to create a PLC internal logic inside the ATS. In this way, user can create any function necessary to manage any kind of application.

In application program logic, all the variables managed internally by the ATS can be entered, such as inputs, threshold limits, remote variables, controller states, etc... With timer menu it's possible to add timings to application.

The processing results of the different branches of the ladder logic are stored in internal variables, which may later be used to control the outputs, or as support memories to build a more complex logic or to control the alarms defined by the user.

With Legrand *Automatic Control Unit Configurator*, the operation of the logic created with the ladder program may be real time checked and modified.

ATS

Automatic transfer switches

3 sources

Reference(s): 4 226 84

4.4 DISPLAY

To enhance and to simplify configuration and navigation, advanced ATSs have a graphic LCD display:

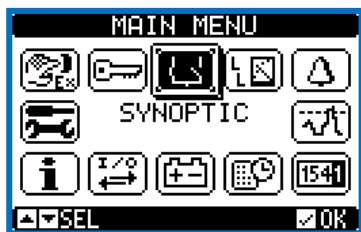

Main menu

Through navigation buttons it's possible to reach any configuration or visualization menu, as, for example, plant synoptic:

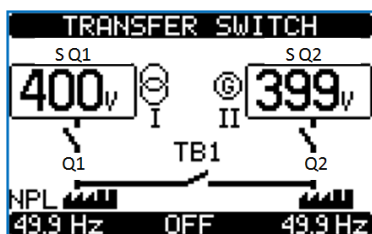

Plant synoptic for 4 226 83

Languages

Advanced ATSs are available with different language packs onboard:

- English (default)
- French
- Spanish
- Russian
- Polish
- Portuguese
- Italian
- German

4.5 CONTROL PANEL

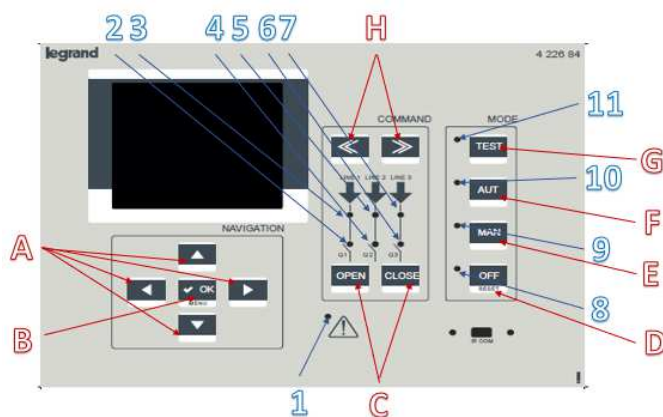

Led	Colour	Status ON	Status OFF	Status BLINK
1	Red	-	-	Alarm active
2,4,6	Yellow	Breaker OPEN/CLOSE status	-	Mismatch between Breaker feedback status and set one
3,5,7	Green	Voltage on Line within limits	-	-
8	Yellow	OFF Mode active	-	-
9	Yellow	MANUAL Mode active	-	-
10	Yellow	AUTO Mode active	-	-
11	Yellow	TEST Mode active	-	-

Button	Behaviour
A	Navigation
B	Confirm and main menu
C	Breakers manual command
D	OFF mode and RESET
E	MANUAL mode
F	AUTO mode
G	TEST mode
H	Breakers manual selection

ATS

Automatic transfer switches

3 sources

Reference(s): 4 226 84

5. CONFORMITY

IEC 60 947-6-1

5.1 MARKING

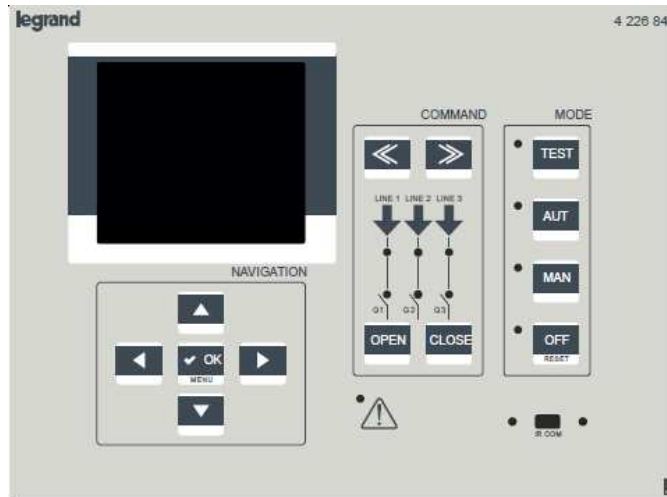

Rear connections

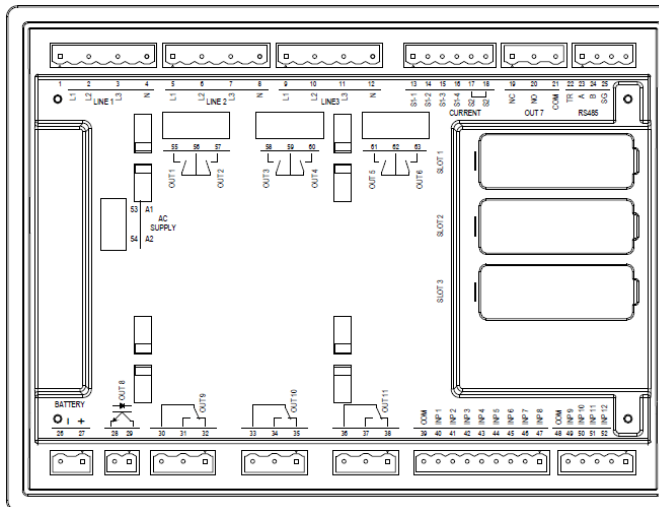

6. EQUIPMENTS AND ACCESSORIES

6.1 Auxiliary power supply

- Auxiliary Dual power supply: it automatically selects the most appropriate source between two single-phase AC power supply lines (based on the presence of voltage within the minimum and maximum preset limits) ref. 4 226 86

		4 226 86
Line 1 and Line 2 voltage inputs	Maximum rated voltage U_n	110 ÷ 230 V AC
	Operating range	80 ÷ 300 V AC
	Frequency range	45 ÷ 66 Hz
	Measuring method	True RMS
	Measuring input impedance	> 8MΩ L-N
	Power consumption/dissipation	7 VA - 2.4 W
Connection methods		Power supplied by the system with phase-to-neutral $\leq 300V$ AC
Measuring accuracy		±1%
Relay outputs	Contact type	2 x 2 NO (presence Line 1 and Line 2) 1 x 2 CO (relay exchange line)
	Max voltage switching	300 V AV
	Rated voltage	250 V AC
	Mechanical endurance	10 ⁷ cycles
	Electrical endurance	10 ⁷ cycles
	Rated current	4A 250V AC I - 1,5A 250V AC AC15
	Rated insulation voltage	U_i 250 V AC
	Rated impulse withstand voltage	U_{imp} 4.8 kV
	Power frequency withstand voltage	2.21 kV
Ambient operating conditions	Operating temperature	-30 °C ÷ +70 °C
	Storage temperature	-30 °C ÷ +80 °C
	Measurement category	III

6.2 Expansion accessories

Plug-in accessories

- 4 opto-isolated static outputs ref. 4 226 90
- 2 relay outputs ref. 4 226 91
- 2 opto-isolated digital inputs and 2 relay outputs ref. 4 226 92

The modules connection can be done simply by plugging them into the expansion slot of the base device which will automatically recognise them. The module parameters setup will be done directly from the main device menu.

Connection procedure

- Remove any dangerous voltage.
- Remove terminal covers and terminal block.
- Remove the expansion slot cover where the module will be plugged in.
- Insert the module into the plug:



- Replace the terminal block and terminal covers.
- Power up the system (the main device will automatically recognise the expansion unit):

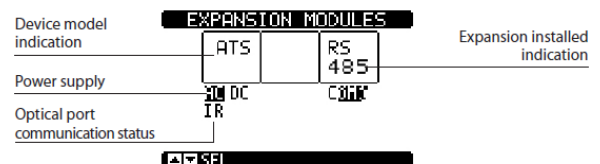

ATS

Automatic transfer switches

3 sources

Reference(s): 4 226 84

Technical data

4 226 90		
SSR output	Type	Solid state relays
	Output ratings (at 60°C)	40 V DC / 30 V AC 55 mA max
Output connection	Type	Plug in/removable terminals
	Number of terminals	4
	Conductor cross section (min/max)	0.2 - 1.5 mm ² (28 - 14 AWG)
	Tightening torque	0.18 Nm
Insulation	Rated impulse withstand voltage	7.3 kV
	Power frequency withstand voltage	4 kV
	Ambient operating conditions	Operating temperature: -20 °C ÷ +60 °C Storage temperature: -30°C ÷ +80°C Degree of protection: IP20

4 226 91		
Relay outputs	Number of outputs	2
	Type	1 changeover
	Rated operating voltage	250 V AC
	Rated current	AC1 5A 250VAC - AC15 1.5A 250V AC, 5A 28 V DC
	Mechanical endurance	10 ⁷ cycles
	Electrical endurance	10 ⁵ cycles
Connection	Type	Plug in/removable terminals
	Conductor cross section (min/max)	0.2 - 2.5 mm ² (28 - 12 AWG)
	Tightening torque	0.5 Nm
Insulation	Rated impulse withstand voltage	7.3 kV (between DMG and outputs) 2.5 kV (between relay outputs)
	Power frequency withstand voltage	4 kV (between DMG and outputs) 1.5 kV (between relay outputs)
	Ambient operating conditions	Operating temperature: -20 °C ÷ +60 °C Storage temperature: -30°C ÷ +80°C Degree of protection: IP20

4 226 92		
Digital inputs	Number of inputs	2
	Type	Negative
	Input current	7 mA
	Input delay	≥ 50ms
	Max frequency (COUNTER cfg)	2 kHz
	Max frequency (STATUS cfg)	50 Hz
Relay outputs	Terminals voltage	5 V DC isolated
	Number of outputs	2
	Type	1 NO
	Rated operating voltage	250 V AC
	Rated current	AC1 5A 250VAC - AC15 0.75A 250V AC, 2A 30 V DC
	Mechanical endurance	10 ⁷ cycles
Connection	Electrical endurance	10 ⁵ cycles
	Type	Plug in/removable terminals
	Conductor cross section (min/max)	0.2 - 2.5 mm ² (24 - 12 AWG)
Inputs insulation	Tightening torque	0.5 Nm
	Rated impulse withstand voltage	4 kV
	Power frequency withstand voltage	2 kV
Outputs insulation	Rated impulse withstand voltage	6.5 kV (contact to low voltage circuits) 4 kV (contact to contact)
	Power frequency withstand voltage	3.6 kV (contact to low voltage circuits) 2.25 kV (contact to contact)
	Ambient operating conditions	Operating temperature: -20 °C ÷ +60 °C Storage temperature: -30°C ÷ +80°C Degree of protection: IP20

Module dimensions

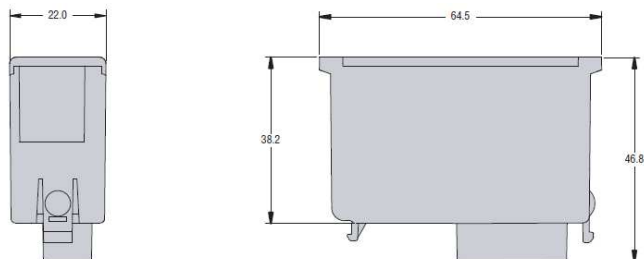

Terminals and connections

4 226 90

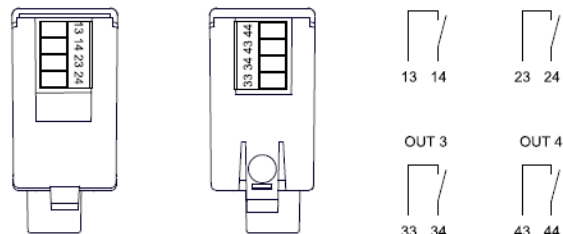

4 226 91

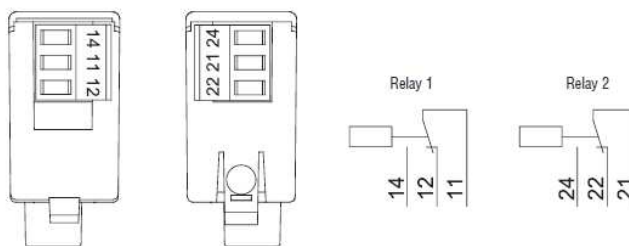

4 226 92

Inputs

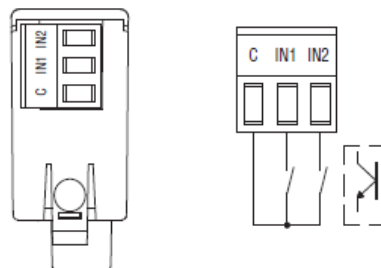

Outputs

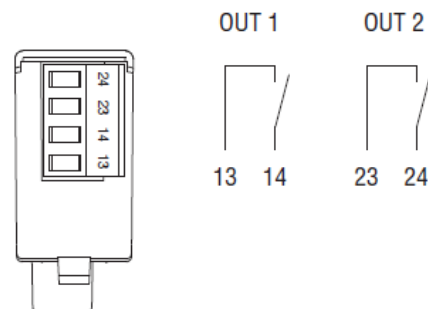

ATS

Automatic transfer switches

3 sources

Reference(s): 4 226 84

6.3 Communication accessories

Plug-in accessories

- Opto-isolated RS485 interface ref. 4 226 89

The module connection can be done simply by plugging it into the expansion slot of the base device which will automatically recognise it. The module parameters setup will be done directly from the main device menu.

Connection procedure

1. Remove any dangerous voltage.
2. Remove terminal covers and terminal block.
3. Remove the expansion slot cover where the module will be plugged in.
4. Insert the module into the plug:



5. Replace the terminal block and terminal covers.
6. Power up the system (the main device will automatically recognise the expansion unit):

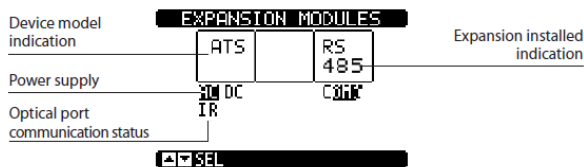

Technical data

4 226 89		
Port connection	Type	Plug in/removable terminals
	Number of terminals	4
	Conductor cross section (min/max)	0,2 - 1,5 mm ² (28 - 14 AWG)
	Tightening torque	0,18 Nm
Insulation	Rated impulse withstand voltage	7,3 kV
	Power frequency withstand voltage	4 kV
Ambient operating conditions	Operating temperature	-20 °C ÷ +60 °C
	Storage temperature	-30°C ÷ +80°C
	Degree of protection	IP20

Module dimensions

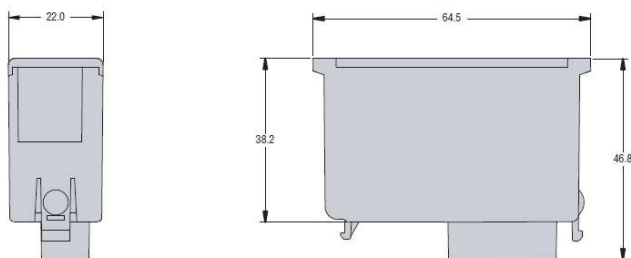

Terminals and connections

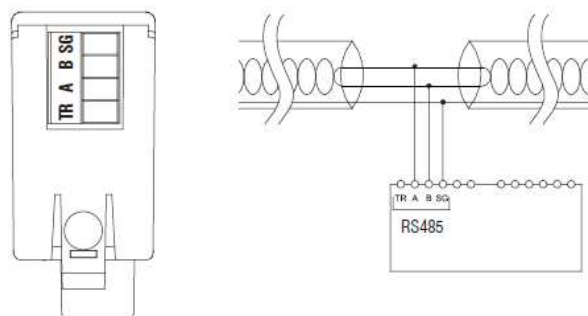

Front side accessories

- USB front connector for programming the automation control units or downloading the event log via PC. Galvanic insulation for safety connections guaranteed by IR communication port toward device. ref. 4 226 87
- WiFi front connector for programming the automation control units or downloading the event log via PC, smartphone or tablet. Galvanic insulation for safety connections guaranteed by IR communication port toward device. ref. 4 226 88

Module description

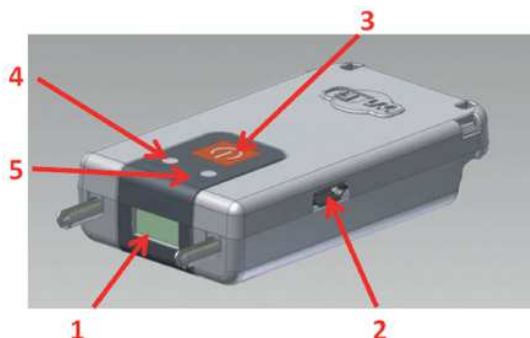

- 1 IR optical port
- 2 Micro USB Connector
- 3 ON/OFF button
- 4 Link state LED
- 5 Battery charge LED

- Charging the battery
Before using the device fully charge the battery, leaving it connected to a USB power source until the battery LED will glow green:

Colour	Battery charge status
Red	< 10%
Orange	>10%, < 90%
Green	> 90%

- Power on
Press and hold the button for 2 seconds to activate WiFi dongle.
- Power off
Press and hold for 3 seconds the button to turn off permanently dongle. The dongle automatically turns off after 30 seconds if it is not placed in front to an active IR port.

ATS

Automatic transfer switches

3 sources

Reference(s): 4 226 84

- Link status LED

Status	IR presence	WiFi status	Data traffic
Red steady	No	-	-
Orange blink	Yes	Connected, Stand-by	-
Orange steady	Yes	Connected, Ready	-
Green steady	Yes	Connected, Active	No
Green blink	Yes	Connected, Active	Yes

- Dongle menu

To enter the dongle menu it is necessary to perform the start-up procedure described below:

- Insert the dongle into the IR port of the device with which you want to communicate.
- Switch on dongle on by pressing the button for 2 s.
- Wait until the "Link status" LED becomes orange flashing.
- Press 3 times consecutively and fast the dongle button.

The base device display will show the Dongle menu.

To navigate the menu dongle use the arrow keys on the basic, following the directions of the bar on the last line of the page.

Select the desired command and confirm it.

For each command from D1 to D4 a second confirmation is requested

before performing the selected operation:

D1: it allows to download the setup menu from the device to the dongle. The data is saved in non-volatile memory of the dongle. If during the data transfer any error occurs (ex: dongle not perfectly connected to the device), then after the download the display will show error message 'CHECKSUM ERROR – RETRY COMMAND'. In this situation the setup data is not saved. Retry D1 command.

D2: it allows to transfer the data stored in the dongle (with previous command D1) to a different device.

D3: it allows to download all the data of the device (setup, page info,

events...) and save it in the non-volatile memory of dongle. If during the data transfer any error occurs (ex: dongle not perfectly inserted in the device IR port) then after the download the display will show error message 'CHECKSUM ERROR – RETRY COMMAND'. In this situation the setup data is not saved. Retry D3 command.

D4: it allows to transfer the data stored in the dongle with the command D3 to a different device.

D5: it shows information about data currently stored in the internal memory of the dongle

Technical data

		4 226 88
Supply	Supply voltage	5 V DC (taken from USB)
	Supply current	400 mA max
	Power consumption/dissipation	2 W
USB		Type B
Battery	Type	Li-Ion
	Rated voltage	3.7 V
	Capacity	700 mA
	Life before recharge	> 5 hours
	Recharging type	Connection to USB host
Ambient operating conditions	Charging current	350 mA max
	Operating temperature	0 °C ÷ +50 °C
	Storage temperature	-20°C ÷ +60°C
Degree of protection	Degree of protection	IP20
	Address	1.2.3.4
IP	Port	2000

Module dimensions

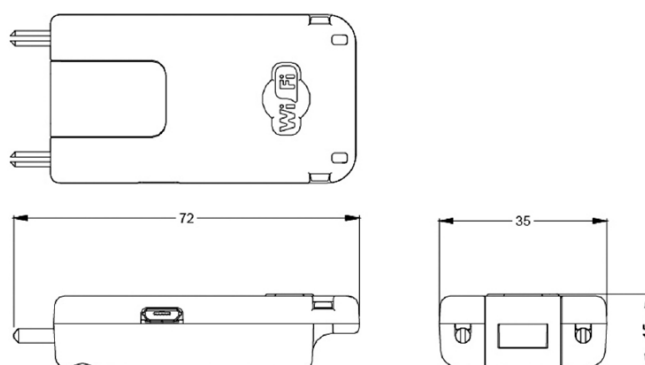

Disposal of Li-Ion batteries

Batteries must be disposed of according to local regulations. The batteries should not be mixed

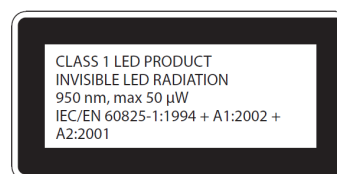

6.4 Software and mobile App

Programming software (*Automatic Control Unit Configurator*) available for download via E-catalogue; App (*Automatic Control Unit Configurator*) for smartphone & tablet available on Apple Store and Google Play.

ATS

Automatic transfer switches

3 sources

7. SYNOPTICS

Many configurations can be done with advanced ATS driver. Here below some schematics.

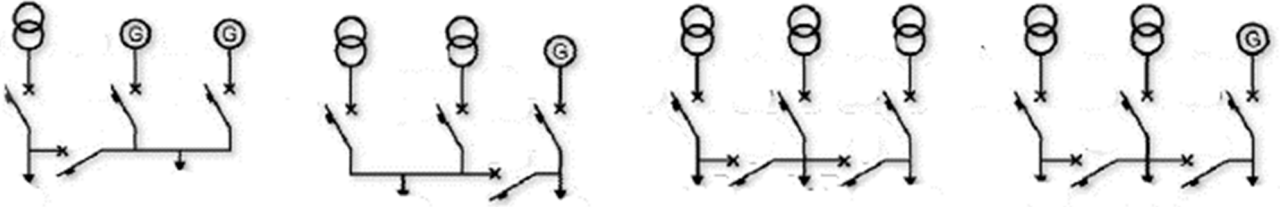

For every possible setup, a range of example synoptic is available on Legrand e-Catalogue. Besides synoptic, parameters configuration files for every product is available on e-Catalogue. Synoptics and configuration files are for free download.

8. SOURCE PRIORITIES

Many configurations are allowed, as all priorities source possible.

Source line or generator, indifferently, can be primary line, secondary line or tertiary line.

ATS

Automatic transfer switches

3 sources

9. OPEN OR CLOSED TRANSITION

Transfer switch equipment can be categorized into two general groups:

- Open-transition transfer devices: open the connected source before closing the new source, causing a total power interruption for a short period of time;
- Closed-transition transfer devices: operate like an open-transition transfer switch when a source has failed, but will parallel the two sources for 100 milliseconds or less and then disconnect when both sources are available, so a total interruption of power is avoided.

4226 84 ATS driver can manage both open and closed transitions.

Open-transition transfer switches

Open-transition transfer switches provide a “break before-make” switching action. They are specifically designed to transfer power between main line and recovery line. The connection to one source is opened before the connection to the second source is closed (a black-out period must occur on loads during transition).

Mechanical interlocks that positively prevent interconnection of sources in automatic and manual modes are commonly used. Open-transition transfer switches are the most commonly used type of transfer switch and are used in all types of applications. By design, they neither require nor allow recovery line paralleling with the main line, in order to have simpler and safer management.

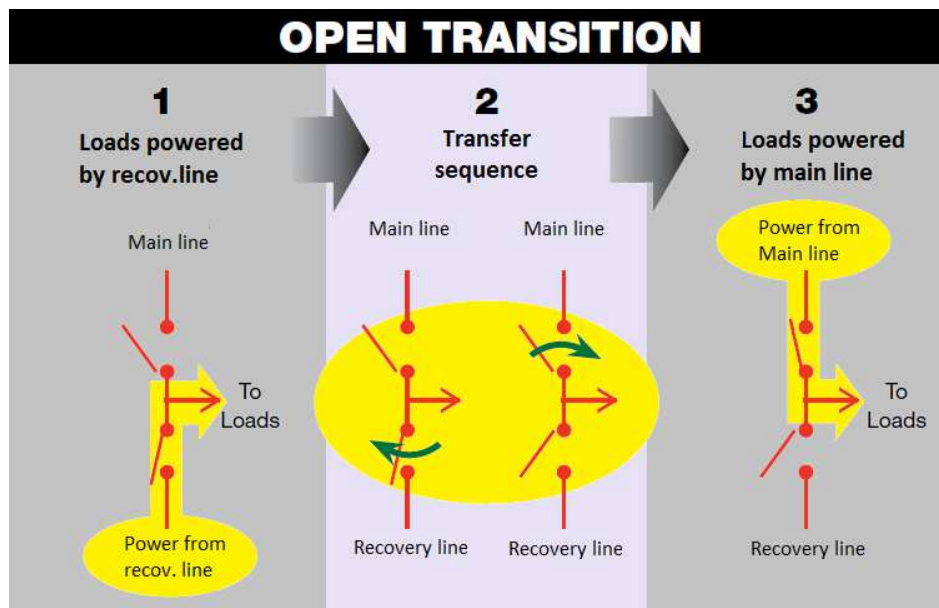

ATS

Automatic transfer switches

3 sources

Closed-transition transfer switches

Closed-transition transfer switches provide a “make-before-break” switching action and utilize a momentary paralleling of two sources, avoiding black out situations on loads.

While fast closed-transition transfer devices switch from sources without a total interruption, there is generally a disturbance in power supplied to the loads due to the sudden load change on the source. This is particularly true when transferring a load from the main line to the recovery one. In general, in order to prevent disruptive transients, fast closed-transition transfer switches must be transferred sequentially, and each switch load should be limited to less than 25 percent of the standby rating of the recovery line.

Due to short timings, this kind of transition is useful in applications with fast motors (as in case of air circuit breakers or DPX³ 1600 with fast closing motor version). So, for closed transitions, a mechanical interlock cannot be compatible.

Simultaneous closing of connections of all three sources it's not allowed, just two at a time.

