

## Universal mini-columns and accessories (NL range)

Number(s) : 0 310 69 – 0 307 87 – 5 102 01/02/03 – 6 530 63 à 65 – 6 530 55/56 – 6 530 58/59 – 6 530 75 – 6 530 84 to 88 – 6 531 40 to 44 – 6 531 50 to 54 — 6 531 60/69/71/78/79– 980976 to 978 – 985 to 990 – 994 to 999

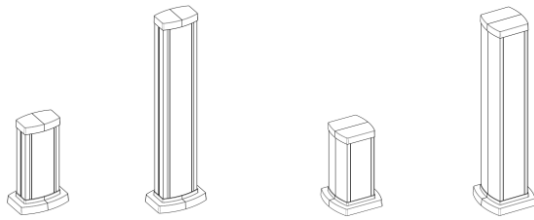

CONTENTS	Pages
1. Description & Composition	.....1
2. Installation	.....1
3. Dimensions	.....2
4. Technical characteristics and standards.....	3
5. Accessories	.....4 to 8
6. Corian	.....9 to 12
7. Spare parts	.....13

### 1. DESCRIPTION & COMPOSITION

1.1 Universal mini-columns 1 – 2 compartments numbers 6 531 40 à 44 -6 531 50 à 54

Range :

			MINI COLUMNS				
			colour	body	cover	0,3m	0,68m
Universal	1 cpt U	white	alu	alu	6 531 40	6 531 43	
		alu	alu	alu	6 531 41	6 531 44	
	2 cpt U	white	alu	alu	6 531 50	6 531 53	
		alu	alu	alu	6 531 51	6 531 54	

- . white = RAL 9003
- . alu = anodized (no RAL)

Characteristics :

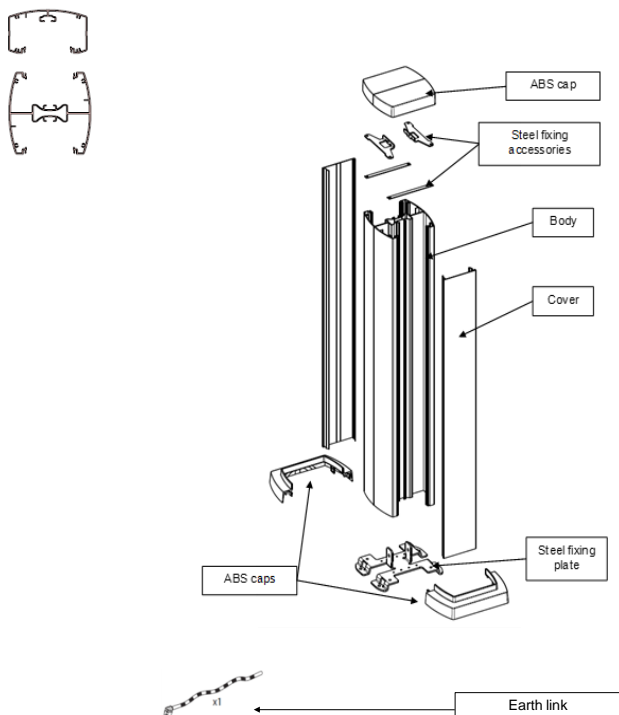

### 2. INSTALLATION

Inside installation only. Be sure to be in accordance with the electrical installation and earthing procedures : automatic earthing of cover.

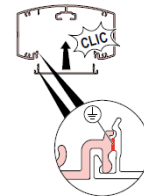

To be used with of Mosaic wiring devices or 80 mm wiring devices. Power supply via cable. Be sure to respect the mini cable length or sheath from the bottom of the mini-column

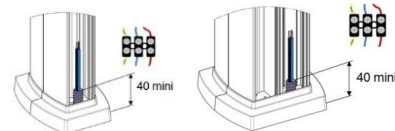

Power supply via the floor with false floor or over floor trunking, or via the ceiling with Ovaline kits numbers 6 530 63/64.

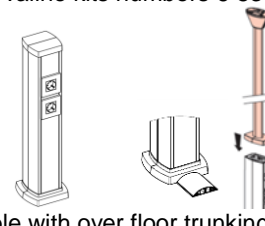

Installation compatible with over floor trunking  
- 50x12 number 0 300 92  
- 75x18 numbers 0 300 88/90/93  
- 92x20 numbers 0 328 00

In order to get a safe and lasting installation, mini-columns have to be screwed on the floor via the plate.

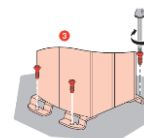

Mini-columns (1 and 2 compartments) can be movable if they are installed with movable foot (6 kg) numbers 6 530 86/87. On special demand, mini-columns may have a maximum height of 1,30 m.

# Universal mini-columns and accessories (NL range)

Number(s) : 0 310 69 – 0 307 87 – 5 102 01/02/03 - 6 530 63 à 65 – 6 530 55/56 – 6 530 58/59 – 6 530 75 - 6 530 84 à 88 - 6 531 40 to 44 – 6 531 50 to 54 – 6 531 60/69/71/78/79– 980976 to 978 – 985 to 990 – 994 to 999

## 3. DIMENSIONS

### 3.1 Mini-column 1 compartment 1 side nrs 6 531 40/41/43/44

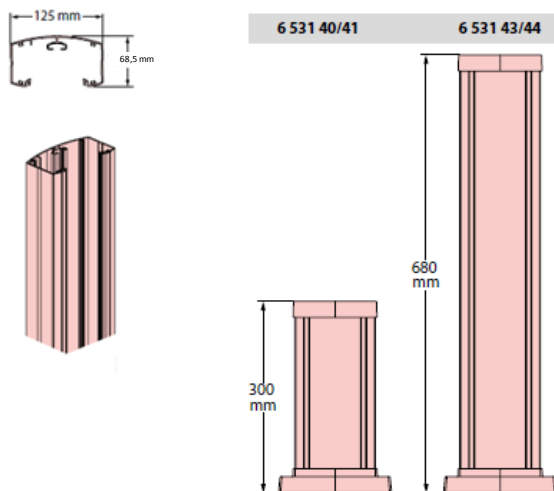

Floor centre distances of the plates

For mini-columns  
nrs 6 531 40/41/43/44

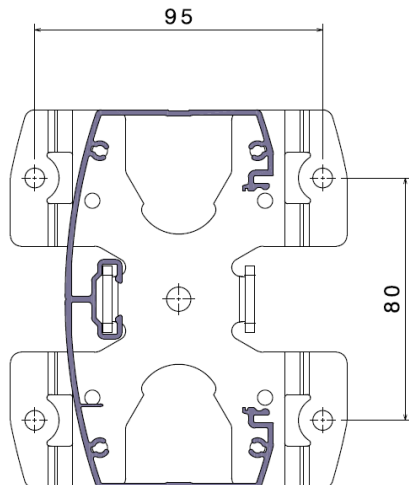

## 3. DIMENSIONS (CONT.)

### 3.2 Mini-column 2 compartments 2 sides nrs 6 531 50/51/53/54

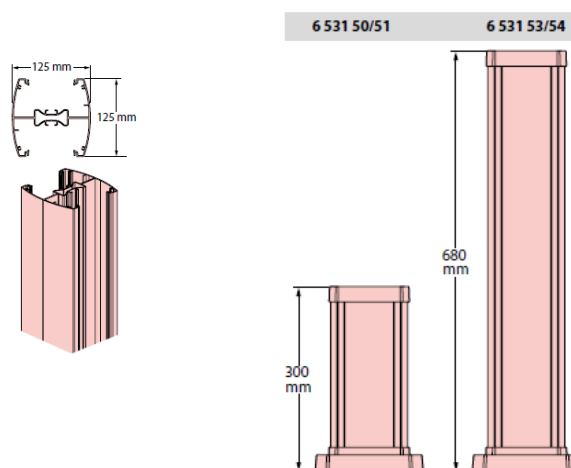

Floor centre distances of the plates

For mini-columns  
nrs 6 531 50/51/53/54

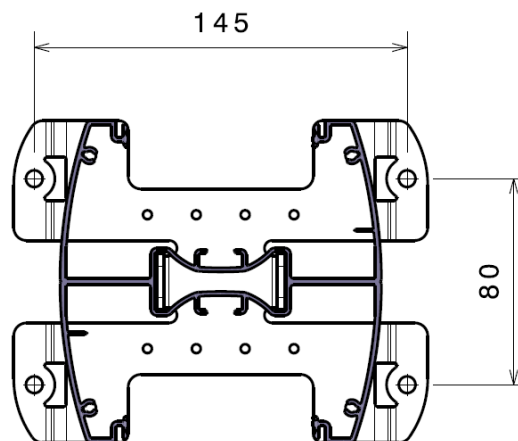

## 4. TECHNICAL CHARACTERISTICS AND STANDARDS

Classifications: EN 50085-1 et EN 50085-2-4



Cable trunking systems and cable ducting systems for electrical installations

6.2 Resistance to impact for installation and application	2J
6.3 Minimum storage and transport temperature	-25°C
6.3 Minimum installation and application temperature	-5°C
6.3 Maximum application temperature	60°C
6.4 Resistance to flame propagation	Non-flame propagating
6.5 Electrical continuity characteristic	Yes
6.6 Electrical insulating characteristic	without electrical insulating characteristic
6.7 Degrees of protection provided by enclosure	1 compartment : IP 3XD 2 compartments : IP 3XD
6.9 The system access cover retention	With a tool
6.101 Floor treatment	dry-treatment of floor
6.102 resistance to vertical load	500 N
Transversal section	<i>look at cabling capacity here under</i>
Protection against mechanical impact	IK07

Reference Cable Trunking systems among EN50085-1 et EN5085-2-5

Designation	Reference
1 compartment	6 531 40/41/43/44
2 compartments	6 531 50/51/53/54

Wiring capacity

1 compartment mini-columns		1 compartment	1 compartment (with 1 MOSAIC mechanism)	1 compartment (with boxes ref. nrs 5 102 01/02/03)
Max. capacity of conductors (for each type of conductor)				
Compartment		A	A	A
Total cross-section (mm <sup>2</sup> )		7100	5250	4100
Number of cables	ø7 mm	100	72	56
	ø9 mm	72	50	30
	ø11 mm	44	32	18

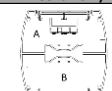
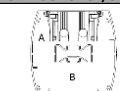
2 compartments mini-columns		2 compartments		2 compartments (with 1 MOSAIC mechanism)		2 compartments (with boxes ref. nrs 5 102 01/02/03)	
Max. capacity of conductors (for each type of conductor)							
Compartment		A	B	A	B	A	B
Total cross-section (mm <sup>2</sup> )		6170	6170	4280	6170	3150	6170
Number of cables	ø7 mm	90	90	58	90	40	90
	ø9 mm	66	66	42	66	27	66
	ø11 mm	40	40	26	40	16	40

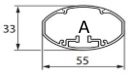
		Rigid Ovaline
Max. capacity of conductors (for each type of conductor)		
Compartment		A
Total cross-section (mm <sup>2</sup> )		1000
Number of cables	Cat. 6 FTP or coaxial ø7 mm	17
	3 x 1,5 mm ø9 mm	9
	3 x 2,5 mm ø11 mm	5

Others characteristics

RoHs material	European directive 2002/95/CE : 27/01/2003
Product Environmental Profile : available	PEP sheet
Coating	International standard DIN EN ISO846

## 5. ACCESSORIES

### 5.1 Ovaline Kits nrs 6 530 63/64

Numbers	Cap colour	Body
6 530 63	white	aluminium
6 530 64	grey	aluminium

Allows an esthetic management of cables coming from the ceiling.

#### Description and composition :

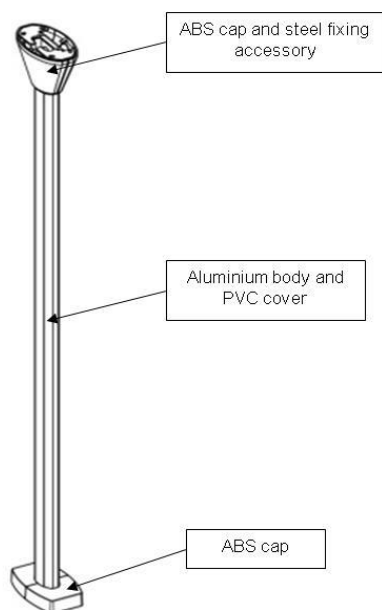

#### Installation :

Adaptable only on 1 compartment cover mini-columns nr 6 531 40/41/43/44

## 5. ACCESSORIES (CONT.)

### Installation on a mini-column

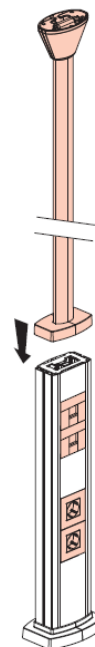

## 5. ACCESSORIES (CONT.)

### 5.1.1 Ovaline tube nr. 6 530 55

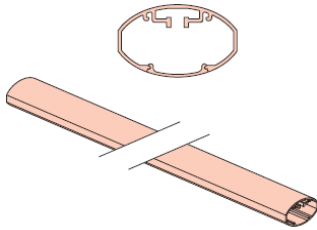

Length 3,20 m

Materials :

- tube : anodised aluminium
- cover : PVC

May be cutted according to the necessary length.

For perfect horizontal connection from the mini-column to cable trays.

To be fixed on Ovaline Kits nrs 6 530 63/64/65.

For horizontal connection to cable trays with junction accessory nr 6 530 58 and fixing bracket nr. 6 530 59.

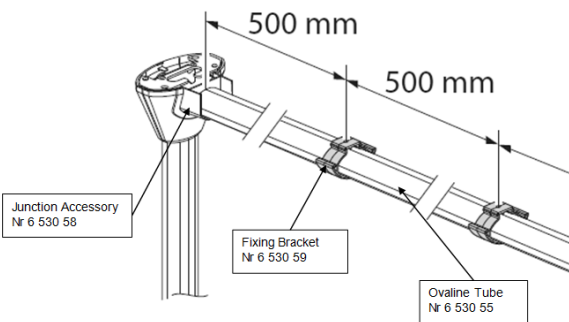

### 5.1.2 Flexible Ovaline kit nr 6 530 56

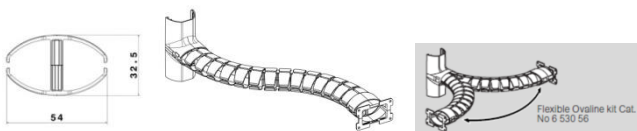

Length : 1 m

Materials :

- Flexible Ovaline : Polypropylene
- Connecting part : ABS

For horizontal connection from mini-columns to cable trays with junction accessory nr 6 530 58 and fixing bracket nr. 6 530 59.

To be fixed on Ovaline Kits nrs 6 530 63/64/65.

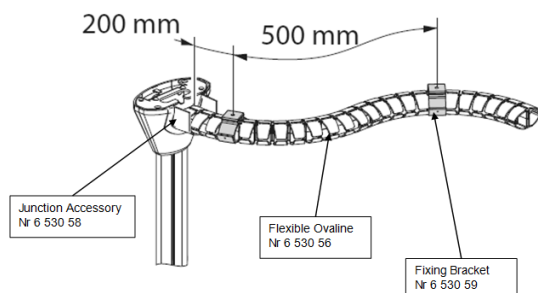

## 5. ACCESSORIES (CONT.)

### 5.1.3 Junction accessory nr 6 530 58 for Ovaline horizontal tube or Ovaline flexible horizontal kit



To be fitted after being cutted

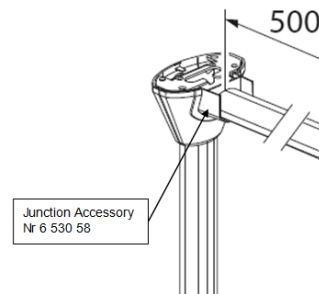

Material : PBT + PC

### 5.1.4 Fixing bracket nr 6 530 59 for Ovaline horizontal tube or Ovaline flexible horizontal kit

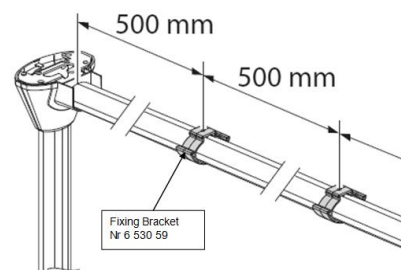

Material : PBT + PC

Installation with Ovaline tube nr 6 530 55

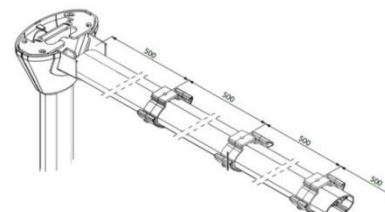

Installation with Ovaline flexible kit nr 6 530 56

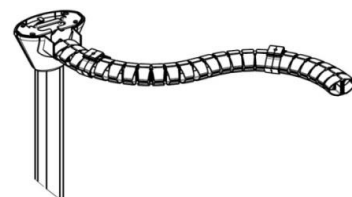

## 5. ACCESSORIES (CONT.)

### 5.2 Foot nr 6 530 86/87 and set of 4 wheels nr 6 530 88

#### 5.2.1 Foot nr 6 530 86/87

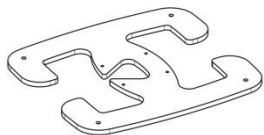

Numbers	Colour
6 530 86	white
6 530 87	aluminium

Dimensions : 400x360x10 mm

Material : Steel

Associated to 1 or 2 compartments, this metallic foot of 6 Kg makes movable your mini-column and allows an optimal stability.

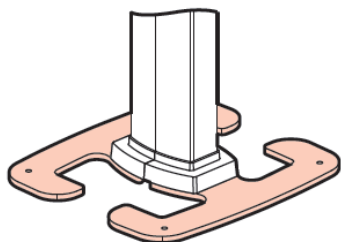

#### 5.2.2 Set of 4 wheels nr 6 530 88

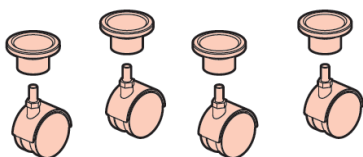

Set of 4 wheels

Material : Plastic

With this set of wheels, your movable mini-column becomes mobile.

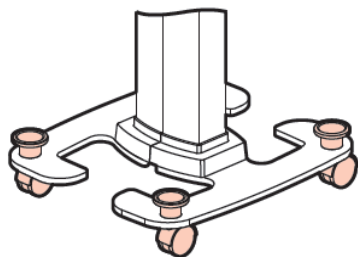

## 5. ACCESSORIES (CONT.)

### 5.3 White table nr 6 530 84



Material : Corian® (cf § 7.1)

Dimensions : 580 x 360 x 12 mm

Maximum weight allowed : 20 kg

Table which can be associated with one mini-column 1 compartment.

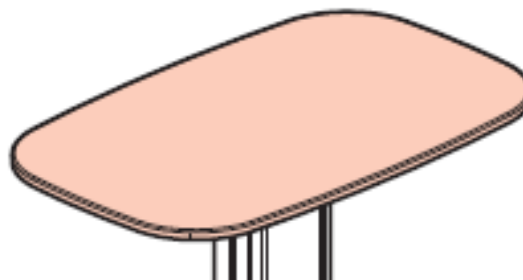

# Universal mini-columns and accessories (NL range)

Number(s) : 0 310 69 – 0 307 87 – 5 102 01/02/03 - 6 530 63 à 65 – 6 530 55/56 – 6 530 58/59 – 6 530 75 - 6 530 84 to 88 - 6 531 40 to 44 – 6 531 50 to 54 – 6 531 60/69/71/78/79– 980976 to 978 – 985 to 990 – 994 to 999

## 5. ACCESSORIES (CONT.)

### 5.4 Metal separation partition nr 6 531 69

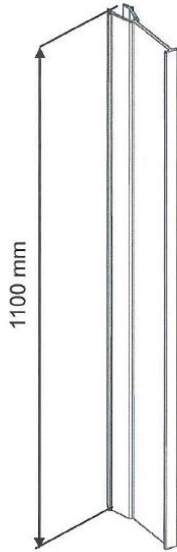

It allows the separation in a same compartment, between power and data cables.

For 1 compartment universal mini-columns,

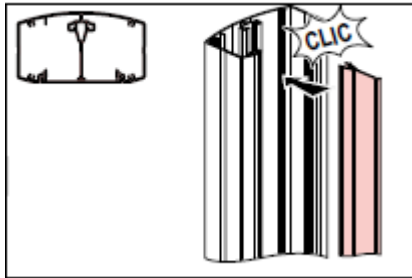

For 2 compartments universal mini-columns,

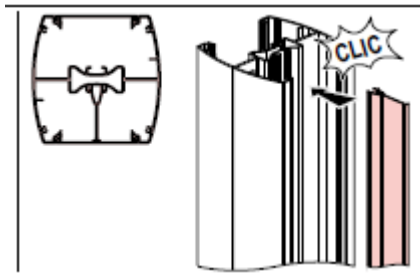

Material : Aluminium

## 5. ACCESSORIES (CONT.)

### 5.5 Metal covers nr 6 531 60/71

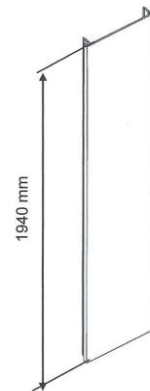

Numbers	Colour
6 531 71	white
6 531 60	aluminium

Useful for replacement for example  
Material : Aluminium

### 5.6 Supports for rail equipment

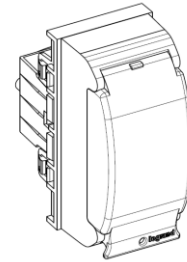

Numbers	Colour
0 310 69	white
0 307 87	aluminium
6 530 75	black

For mounting  equipment (such as MCBs) on mini-columns.  
To be used with two 0.5 module spacing units cat. Nr 4 063 07  
Capacity : 1 module  
Equipped with protective cover to prevent unwanted triggering

Material : ABS (back part) + PC (front part)

### 5.7 Support nr 6 531 78

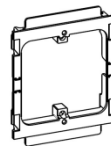

Support for mounting Mosaic wiring accessories 2 and 3 modules  
Material : ABS

# Universal mini-columns and accessories (NL range)

Number(s) : 0 310 69 – 0 307 87 – 5 102 01/02/03 - 6 530 63 à 65 – 6 530 55/56 – 6 530 58/59 – 6 530 75 - 6 530 84 to 88 - 6 531 40 to 44 – 6 531 50 to 54 – 6 531 60/69/71/78/79– 980976 to 978 – 985 to 990 – 994 to 999

## 5. ACCESSORIES (CONT.)

### 5.8 Support nr 6 531 79

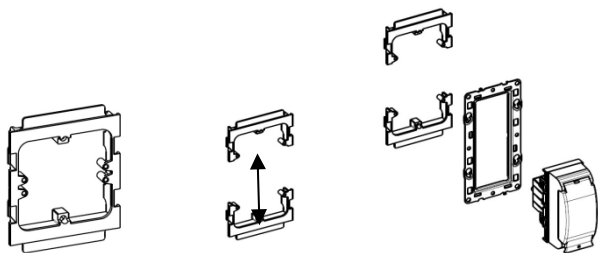

Support for mounting 4, 5, 6, 7, 8 modules Arteor or Mosaic and Belanko wiring accessories.

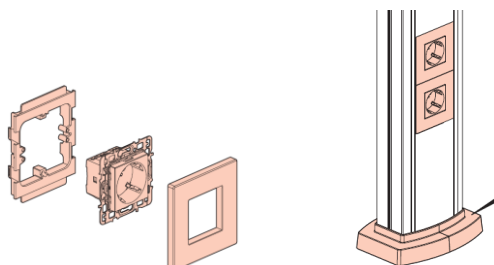

Material : ABS

## 5. ACCESSORIES (CONT.)

### 5.9 Boxes

nr 5 102 01 1 gang mounting box

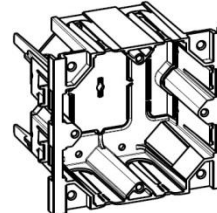

nr 5 102 02 2 gang mounting box

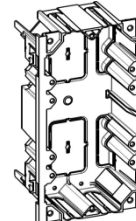

nr 5 102 03 Junction box

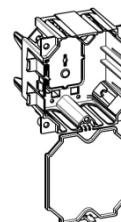



## 6. CORIAN

### 6.1. Characteristics



## Short Form Classification Report No. 16893B

### PRODUCT

DuPont Corian® Solid Surface

### SPONSOR

DuPont De Nemours (Belgium) BVBA

### PRODUCT DETAILS

- Thickness: Between 6 mm and 12.3 mm ( $\pm 0.7$  mm)
- Density: Between 1645 kg/m<sup>3</sup> and 1770 kg/m<sup>3</sup>
- Colour/pattern: Any colour variation allowed
- Use of fire retardants: No
- Product composition: No variation allowed
- Product construction: No variation allowed

### FIELD OF APPLICATION

- Construction applications used over any substrate with a density equal to or greater than 800 kg/m<sup>3</sup>, having a minimum thickness of 12.5 mm and a fire performance of A2 or better.
- Product installed utilizing Corian® silicone sealant only

### CLASSIFICATION

C-s1,d0

### STANDARDS

Test standards: EN ISO 11925-2:2002 & EN 13823:2002  
Classification standard: EN 13501-1:2007

#### SIGNED BY

  
Niek De Pauw (Signature)  
Project assistant  
Ghent  
2016.06.14 13:22:00 +02'00'

#### APPROVED BY

  
Bart Sette (Signature)  
General Manager  
2016.06.15 10:27:43  
+02'00'

For and on behalf of WFRGENT nv

This short form classification report has been drafted according to EGOLF agreement EGA 08rev2:2013 "Application note: clause 5.10 [5.10/1] – Types of test reports used in fire testing". Whilst the test data and classification provided within this short form report was obtained in a test conducted fully in accordance with the standards EN ISO 11+25-2:2002, EN 13823:2002 and EN 13501-1:2007, the presentation of the results in this short form report may not satisfy the requirements of those standards and EN ISO/IEC 17025:2005/AC:2006. The presentation of the results in this manner is made by agreement with the sponsor and use of the information herein for product assessment, approval or certification purposes will be restricted.

The full classification report No.185122 (Issue 4) is available at DuPont De Nemours (Belgium) BVBA.

This document is the original version of this report and is written in English. This document may be used only literally and completely for publications. For publications of certain texts, in which this document is mentioned, our permission must be obtained in advance.

The authenticity of the electronic signatures is assured by Belgium Root CA.



WFRGENT NV - Ottergemsesteenweg-Zuid 711 - B-9000 Cent - België  
t: +32 9 243 77 50 - f: +32 9 243 77 51 - e: info@wfrgent.com  
BTW/VAT/TVA: BE0870.418.414 - Ondernemingsnummer: RPR GENT 0870.418.414

WFRGENT NV is een spin-offbedrijf van de Universiteit Gent, voorheen Laboratorium voor Aamvonding der Brandstoffen en Warmteoversdracht - Afdeling Brandveiligheid  
WFRGENT NV is a spin-off company from the University of Ghent, previously the Laboratory for Heat Transfer and Fuel Technology - Fire Safety Division  
WFRGENT SA est une compagnie spin-off de l'Université de Gand, autrefois le Laboratoire pour l'Emploi des Combustibles et la Transmission de la Chaleur - Division Sécurité Incendie

## 6. CORIAN (CONT.)

### 6.1. Cleaning



**Caring for DuPont™ Corian®**

**Pleje af DuPont™ Corian®**

**Pflegehinweise für DuPont™ Corian®**

**Uso y cuidado de DuPont™ Corian®**

**Entretien des produits DuPont™ Corian®**

**Cura dei materiali DuPont™ Corian®**

**Onderhoud van DuPont™ Corian®**

**Vedlikehold av DuPont™ Corian®**

**Wskazówki dotyczące użytkowania i konserwacji materiału DuPont™ Corian®**

**Skötsel av DuPont™ Corian®**

**DuPont™ Corian® 'in Bakımı**

**Φροντίδα του DuPont™ Corian®**

**Уход за поверхностями DuPont™ Corian®**



**Corian.**



ENDLESS EVOLUTION

## 6. CORIAN (CONT.)

### 6.1. Cleaning

ENGLISH

### Caring for DuPont™ Corian®

DuPont™ Corian® was created for a lifetime of easy care. Just follow the simple guidelines listed here to help keep your Corian® surfaces looking beautiful.

#### Routine care of your Corian® surface

For everyday cleaning, use soapy water or widely available surface cleaners.

Remove excess detergent with a soft cloth, rinse surface with warm water and dry with a soft cloth.

If necessary use a microfibre cloth and rub over the surface with an ammonia based cleaner, then rinse with water.

This procedure will remove most dirt and residue from your Corian® surfaces.

Always clean using a circular motion, from the front to the back, then side to side, overlapping the circles until the entire area has been cleaned. Do not use abrasive or mild abrasive cleaners on high gloss or dark surfaces.

Be aware that limescale can build up if water is left to dry on the surface.

To prevent this, it is important to wipe the surface completely dry with a microfibre cloth after spills and cleaning.

Some colours of Corian® may require more frequent cleaning to maintain a uniform finish.

#### Special care for stubborn stains

Residues from stubborn stains may require heavier cleaning.

Follow the recommendations below to clean these specific stains from your Corian® surface and shapes effectively.

**Vinegar, coffee, tea, lemon juice, vegetable juice, dyes, ketchup, lily pollen, saffron, light scratches, cigarette burns, shoe polish, ink, marker pen, iodine, mildew, mercurochrome, blood, red wine, perfume:**

Use a damp microfibre cloth and a mild abrasive cleaning product (except on high gloss or dark surfaces).

**Grease, fat and oil residues:** Use a microfibre cloth and rub over the stain with some diluted bleach.

Rinse several times with warm water and dry with a soft cloth.

Bleach can discolour DuPont™ Corian® if not removed completely by rinsing with water afterwards.

**Hard water scale, soap, minerals:** Use a microfibre cloth and rub over the stain with a standard household limescale remover or vinegar and leave for 2-4 minutes.

Using a second clean microfibre cloth, rinse the area thoroughly with water.

**Nail varnish spills:** Use a microfibre cloth and rub over the stain with a non-acetone based nail varnish remover.

Rinse several times with warm water and dry with a soft cloth.

If the stain is still visible, repeat the operation, this time using very fine-grain sanding paper; If the stain persists, contact our Warranty Centre.

#### How to prevent permanent damage

Be sure to follow these guidelines to help prevent permanent damage to your Corian® installation.

Avoid getting strong chemicals – eg paint removers, oven cleaners, acid drain cleaners, acetone based nail varnish removers etc – on your surface. If a spill does occur, promptly flush the surface with water to fully rinse off the chemical.

Do not clean using aggressive chemical agents such as acetone, oven cleaners, thinners, strong acids (muriatic acid etc) or strong bases (caustic soda etc), or industrial detergents or paint solvents.

If a spill does occur, promptly flush the surface with water to fully rinse off the chemical.

Do not use metal scrapers, iron brushes or other domestic metal tools to remove stains, paints, plaster or other substances.

In the case of severe damage, please contact the DuPont™ Corian® Warranty Centre, which will put you in touch with a local DuPont™ Corian® Quality Network Industrial Partner or Service Centre for professional re-sanding or repairing of your DuPont™ Corian® installation. DuPont™ Corian® Quality Network Service Centres are certified by DuPont to carry out expert repair and finishing work. They can also handle installation work and offer maintenance contracts to commercial customers to maintain DuPont™ Corian® installations in prime condition.

#### Kitchen applications

##### SPECIAL CARE FOR SINKS

Remove all the fat and oil residues resulting from food preparation from the sink, using a detergent or surface cleaner. If necessary, use a mild abrasive cleaning pad or sponge.

Fill the sink with diluted household bleach (25% bleach and 75% water) and leave for ½ hour. Afterwards, rinse thoroughly – you should have a beautifully clean sink, with very little effort.

## 6. CORIAN (CONT.)

### 6.1. Cleaning

ENGLISH 

#### PREVENTING HEAT AND OTHER DAMAGE

It is important to minimise direct heat exposure to protect your Corian® surface. Always use a heat protection pad, trivet (with rubber feet) or protective sink mat for hot cookware, or leave cookware to cool on the hob first. Never put hot pans, particularly cast iron pans, directly onto a DuPont™ Corian® top or in a Corian® sink. Always use the correct size pan on the hob and place it centrally on the ring.

An overhanging pan can scorch the surrounding surface.

As with most sinks, pouring boiling liquids directly into a DuPont™ Corian® sink without running cold water at the same time may damage the material. If you have an instant boiling water tap, a container should always be used to collect the water as boiling water from this type of tap may cause surface damage in and around the sink. Do not cut directly on Corian® surfaces. Use a chopping board.

#### Bathroom applications

##### DAILY MAINTENANCE OF WASH BASINS, SHOWER TRAYS AND BATHTUBS

Simply clean the surface with soapy water or any common detergent in order to remove most of the stains and dirt that may be deposited. Gel or creamy detergents are particularly recommended, together with a mild abrasive cleaning pad or sponge, ensuring that you rinse the treated area properly.

By doing this, the original matt finish will be maintained. Some substances such as ink, cosmetics and dyes may release colour onto the surface after extended contact with the surface.

All of these can easily be removed by following the special instructions for stubborn stains.

#### ATTENTION

Shower trays and bathtubs cannot be used autonomously by people with reduced motor skills, or with sensory and/or cognitive impairments (including children).

For your personal safety, use them at a maximum water temperature of 40°C.

Avoid using them in the vicinity or while using electrical appliances.

Pay special attention when using shower trays and bathtubs alone or after taking medicines.

#### Guaranteed Quality

With proper care, your Corian® surface will stay looking like new. Your DuPont™ Corian® surface carries a Limited Installed Warranty when fabrication and installation are carried out by a Corian® Industrial Partner and member of the Corian® Quality Network. If you decide to sell your home, your warranty is transferable to the new owners. For complete details, go to our website ([www.corian.com](http://www.corian.com)) to review the warranty guidelines applicable for your product.

*This information is based on technical data that E. I. du Pont de Nemours and Company and its affiliates ("DuPont") believe to be reliable, and is intended for use by persons having technical skill and at their own discretion and risk. DuPont cannot and does not warrant that this information is absolutely current or accurate, although every effort is made to ensure that it is kept as current and accurate as possible. Because conditions of use are outside DuPont's control, DuPont makes no representations or warranties, express or implied, with respect to the information, or any part thereof, including any warranties of title, non-infringement of copyright or patent rights of others, merchantability, or fitness or suitability for any purpose and assumes no liability or responsibility for the accuracy, completeness, or usefulness of any information. This information should not be relied upon to create specifications, designs, or installation guidelines. The persons responsible for the use and handling of the product are responsible for ensuring the design, fabrication, or installation methods and process present no health or safety hazards. Do not attempt to perform specification, design, fabrication, or installation work without proper training or without the proper personal protection equipment. Nothing herein is to be taken as a license to operate under or a recommendation to infringe any patents. DuPont shall have no liability for the use of or results obtained from such information, whether or not based on DuPont's negligence. DuPont shall not be liable for (i) any damages, including claims relating to the specification, design, fabrication, installation, or combination of this product with any other product(s), and (ii) special, direct, indirect or consequential damages. DuPont reserves the right to make changes to this information and to this disclaimer. DuPont encourages you to review this information and this disclaimer periodically for any updates or changes. Your continued access or use of this information shall be deemed your acceptance of this disclaimer and any changes and the reasonableness of these standards for notice of changes.*



# Universal mini-columns and accessories (NL range)

Number(s) : 0 310 69 – 0 307 87 – 5 102 01/02/03 - 6 530 63 à 65 – 6 530 55/56 – 6 530 58/59 – 6 530 75 - 6 530 84 to 88 - 6 531 40 to 44 – 6 531 50 to 54 — 6 531 60/69/71/78/79– 980976 to 978 – 985 to 990 – 994 to 999

## 7. SPARE PARTS

			MINI COLUMNS		SPARE PARTS				
			0,3m	0,68m					
			standard	standard	Lower cap (2 parts)		Upper cap (1 part)		
Universal		1 cpt U	6 531 40	6 531 43	980985		980994		
			6 531 41	6 531 44	980986		980995		
		2 cpt U	6 531 50	6 531 53	980988		980997		
			6 531 51	6 531 54	980989		980998		

			KIT OVALINE	SPARE PARTS		
				Cap (2 parts)		
Universal		1 cpt U	6 530 63	980976		
			6 530 64	980977		
		2 cpt U				