

Measuring Device, 4 DIN modules, connection via CT, with RS485 port

Cat. N°: 4 120 45



Contents	Pages
1. Description - Use.....	1
2. Range	1
3. Overall dimensions.....	1
4. Preparation - Connection	1
5. General characteristics.....	2
6. Compliance and approvals.....	4
7. Communication	7

1. DESCRIPTION - USE

Measuring Device.

Measures the main electrical quantities of a single-phase or three-phase network.

The insertion is done by measuring current transformers (CT).

2. RANGE

. Cat. N° 4 120 45: Multifunction measuring device, 4 DIN modules width (17,8 mm per pole), Modbus RS485 output and pulse output integrated.

Width:

. 4 modules (4 x 17,8 mm = 71,2 mm).

Auxiliary supply:

. 230 V~, 50/60 Hz

Rated current:

. Rated current, In: 5 A (via external current transformer x/5 A)

. Max, current:

Imax: 1,2 In = 6 A

Insertion rated voltages:

. Un: 80÷500 V~ (phase/phase)

. Un: 50÷290 V~ (phase/neutral)

Rated frequency:

. fn: 50 Hz

. Admitted variation:

45 ÷ 65 Hz

3. OVERALL DIMENSIONS

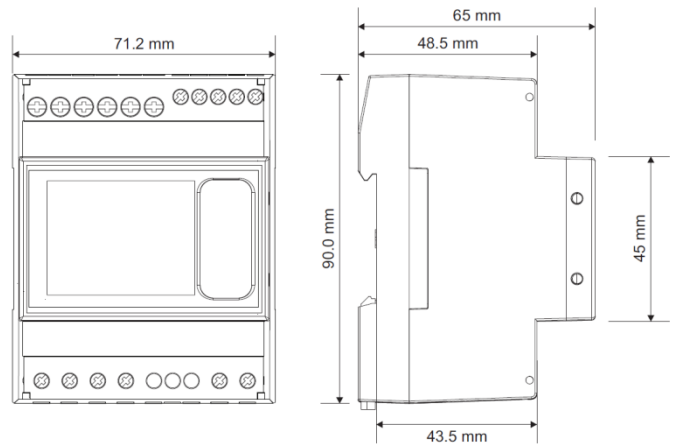

4. PREPARATION - CONNECTION

Fixing:

. On symmetrical EN/IEC 60715 rail or DIN 35 rail.

Operating position:

. Vertical Horizontal Upside down On the side

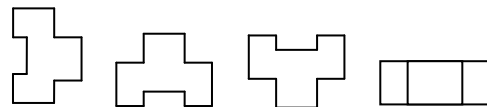

Screw terminals:

. Terminal depth: 8 mm.

. Stripping length: 8 mm

Screw head:

. Screw slotted and Philips.

Recommended tightening torque:

. CTs terminals (I₁, I₂, I₃): 1 Nm.

. Voltage measurement terminals (V₁, V₂, V₃, N), Output (3, 4),

RS485 (+, -, SG), Auxiliary supply (Aux.): 0,6 Nm.

Measuring Device, 4 DIN modules, connection via CT, with RS485 port

Cat. N°: 4 120 45

4. PREPARATION - CONNECTION (continued)

Tools required:

- . CTs terminals: flat screwdriver 4 mm or Philips PH1
- . Other terminals: flat screwdriver 2,5 mm or Philips PH0
- . For fixing the device on the DIN rail: flat screwdriver 5.5 mm (from 4 to 6 mm).

Connectable section:

- . Copper cables.
- . CTs Terminals

	Without ferrule	With ferrule
Rigid cable	0,05 to 6 mm ²	-
Flexible cable	0,05 to 4 mm ²	0,05 to 4 mm ²

- . Other terminals

	Without ferrule	With ferrule
Rigid cable	0,05 to 4 mm ²	-
Flexible cable	0,05 to 2,5 mm ²	0,05 to 2,5 mm ²

Wiring diagrams:

- . 4 wires three-phase network, 3 CT (3N-3E):
3N-3E

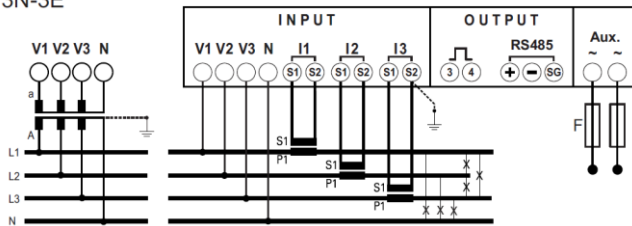

- . 3 wires three-phase network, 2 CT (3-2E):
3-2E (1-3)

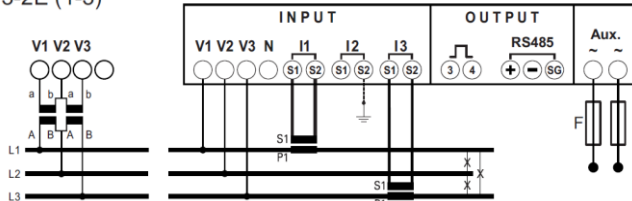

- . 3 wires three-phase network, 3 CT (3-3E):
3-3E

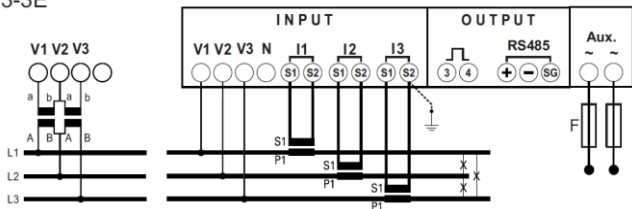

- . single phase network (1N-1E):
1N1E

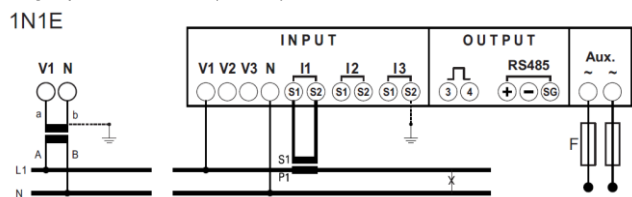

5. GENERAL CHARACTERISTICS

Case marking:

- . By permanent ink pad printing.

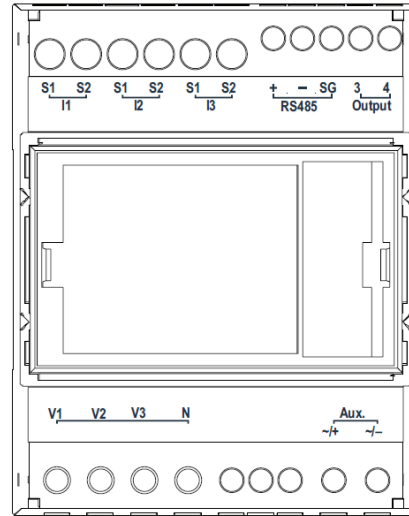

Front face marking:

- . Adhesive foil:



Display

- . Type: LCD back lighted.
- . Resolution: automatic adjustment of the display resolution for the decimal digits and for the engineering units as a function of the transformation ratio of the external current transformers (kTA^1)
¹ kTA = external CTs ratio
(ex. 800A / 5A, $kTA = 160$).
- . Refresh time: 1,1 sec.
- . Automatic backlight reduction, after 20 sec. of keyboard inactivity

Measuring sensors operating range:

- . Max CTs primary current: 50 kA

Note: Changing of the parameter kTA in the setup menu of the device, all the energy counters are reset.

Count starting time:

- . $t < 5$ sec (IEC/EN 62053-21, IEC/EN 62053-23).

Value display and Programming:

- . Using front keyboard, 4 keys (refer to user manual).

5. GENERAL CHARACTERISTICS *(continued)*

Measured quantities and Accuracy class:

- . Phases Current, I₁, I₂, I₃: accuracy 0,5
Neutral Current, I_N: accuracy 3
- . Voltage (accuracy 0,5):
phase/phase: U₁₂, U₂₃, U₃₁;
phase/neutral: V_{1N}, V_{2N}, V_{3N}.
- . Frequency (accuracy ± 0,1 Hz)
- . Power:
instantaneous active total power, phase, average value and max.
average value (accuracy 1);
instantaneous reactive total power, phase, average value and
max. average value (accuracy 1);
instantaneous apparent total power, phase, average value and
max. average value (accuracy 1);
- . Power factor a (accuracy 1).
- . Energy:
total and partial active energy, positive and negative
(accuracy 1);
total and partial reactive energy, positive and negative
(accuracy 1).
- . THD (accuracy 2):
voltages THD: V₁, V₂, V₃ o U₁₂, U₂₃, U₃₁;
currents THD: I₁, I₂, I₃, I_N.

Measurements update period

- . 0,2 s

RS485 communication port's characteristics:

- . Programmable addresses: from 1 to 247
- . Baud rate: 4,8 - 9,6 - 19,2 - 38,4 kbps
- . Parity bit: none, even, odd
- . Stop bit: 1
- . Galvanically isolated respect to measuring inputs and auxiliary
supply
- . Standard RS485 3 wires, half-duplex
- . Protocol Modbus® RTU
- . Response time (time out question/answer): ≤200 ms

Pulse output's characteristics:

- . Optorelays with potential-free SPST-NO contact
- . Type S0 (IEC/EN62053-31)
- . Voltage U_{imp}: max. 27 Va.c./d.c.
- . Current I_{imp}: max. 50 mA
- . Programmable pulse weight, possible values: 10 – 100 - 1k - 10k -
100k - 1M - 10M Wh/imp or varh/imp
- . Programmable pulse duration, possible values: 50 - 100 - 200 -
300 ms.

Plastic material:

- . Self-extinguishing polycarbonate.

Ambient operating temperature:

- . Min. = - 5 °C Max. = + 55 °C.

Ambient storage temperature:

- . Min. = - 25 °C Max. = + 70 °C.

Device protection:

- . Recommended fuse 0,5 A type gG

5. GENERAL CHARACTERISTICS *(continued)*

Protection Index:

- . Protection index of terminals against solid and liquid bodies (wired
device): IP 20 (IEC/EN 60529).
- . Protection index of the front face against solid and liquid bodies:
IP 54 (IEC/EN 60529).

Impulse withstand voltage:

- . Supply / Measuring inputs:
wave 1,2 / 50 µs 0,5 J: 6kV
alternate current 50 Hz / 1 min.: 3 kV
- . Supply / RS485 port:
wave 1,2 / 50 µs 0,5 J: 6kV
alternate current 50 Hz / 1 min.: 3 kV
- . Measuring inputs / Pulse output:
wave 1,2 / 50 µs 0,5 J: 6kV
alternate current 50 Hz / 1 min.: 3 kV
- . All circuits / earth:
alternate current 50 Hz / 1 min.: 4 kV

Pollution degree:

- . 2

Installation category:

- . III

Average weight per device:

- . 0, 250 kg.

Volume when packed:

- . 0,70 dm³.

Consumption

- . ≤ 2,5 VA (a.c. supply)
- . ≤ 3,5 W (d.c. supply)

Thermal power dissipated:

- . ≤ 5 W.

Phase sequence correction diagnostic:

- . In the software of the device there is a specific functionality to
detect and correct problems concerning voltage and / or current
connections.
The "Testing connections" functions can be activated with a specific
password for connections 3-2E, 3-3E e 3N-3E.
Conditions for the execution of the function:
- multifunction device 4 120 45 must have current and voltage on
each phase and the neutral, if present, must be connected to the
corresponding terminal "N".
In addition, the test function requires:
- an electrical 120° three-phase system.
- a value of the power factor PF > 0,5 for 3N-3E and 3-3E or PF >
0,71 for 3-2E.
If the power factor of the system is not included in these ranges, the
function cannot be used.
- no crossings between cables connected to secondary of CTs (ex.
TA phase 1 → terminals S1 and S2 of I1 and so on).
- . Procedure's access codes:
3333: Start of diagnostic procedure
4444: Display of the current configuration
5555: Restore the default configuration (factory configuration)

6. COMPLIANCE AND APPROVALS

Compliance to standards:

- . Compliance with Directive on electromagnetic compatibility (EMC) n° 2014/30/EU
- . Compliance with low voltage directive no. 2014/35/EU
- . Electromagnetic Compatibility:
 - emission according IEC/EN 61326-1, class B
 - immunity according IEC/EN 61326-1.
- . Active energy accuracy class: 1 (E_a, IEC/EN 61557-12).
- . Reactive energy accuracy class: 1 (E_{rv}, IEC/EN 61557-12).

Environment respect – Compliance with EU directives:

- . Compliance with Directive 2011/65/EU known as “RoHS 2” on the restriction of the use of certain hazardous substances in electrical and electronic equipment.
- . Compliance with REACH regulation: at the date of the publication of this document no substance from the candidate list is present in these products.

Plastic materials :

- . Halogens-free plastic materials.
- . Marking of parts according to ISO 11469 and ISO 1043.

Packaging :

- . Design and manufacture of packaging compliant to decree 98-638 of the 20/07/98 and also to directive 94/62/CE.

Conformity table to IEC 61557-12 Edition 1 (08/2007)

Performance measuring and monitoring devices (PMD) characteristics		
Type of characteristic	Specification values	Other complementary characteristics
Power quality assessment function	-	-
Classification of PMD	SD / SS	-
Temperature	K55	-
Humidity + Altitude	Standard conditions	-
Active power and Active energy function performance class	1	-

6. COMPLIANCE AND APPROVALS *(continued)*

Conformity table to IEC 61557-12 Edition 1 (08/2007) *(continued)*

Function symbols	Function performance class according to IEC 61557-12	Measuring range	Other complementary characteristics
P	1	0,1 ÷ 6 A	-
Q _A , Q _V	1	0,1 ÷ 6 A	-
S _A , S _V	1	0,1 ÷ 6 A	-
E _a	1	0 ÷ 9999999,9 MWh	0,1 ÷ 6 A
E _{rA} , E _{rV}	1	0 ÷ 9999999,9 Mvarh	0,1 ÷ 6 A
E _{apA} , E _{apV}	-	-	-
f	± 0,1 Hz	45 ÷ 65 Hz	-
I	0,5	0,5 ÷ 6 A	-
I _N , I _{Nc}	3 %	0,5 ÷ 6 A	-
U	0,5	50 ÷ 300 V (Ph/N)	-
P _{FA} , P _{FV}	1	0,5 ind ÷ 0,8 cap	-
P _{st} , P _{It}	-	-	-
U _{dip}	-	-	-
U _{swt}	-	-	-
U _{tr}	-	-	-
U _{int}	-	-	-
U _{nba}	-	-	-
U _{nb}	-	-	-
U _h	-	-	-
THD _u	2	> 1,5 %	-
THD-R _u	-	-	-
I _h	-	-	-
THD _i	2	> 3%	-
THD-R _i	-	-	-
Msv	-	-	-

6. COMPLIANCE AND APPROVALS *(continued)*

Conformity table to IEC 61557-12 Edition 1 (08/2007) *(continued)*

Characteristics of "Power quality assessment functions"			
Function symbols	Function performance class according to IEC 61557-12	Measuring range	Other complementary characteristics
f	$\pm 0,1$ Hz	45 ÷ 65 Hz	-
I	0,5	0,5 ÷ 6 A	-
I _N , I _{Nc}	3 %	0,5 ÷ 6 A	-
U	0,5	50 ÷ 300 V (Ph/N)	-
U _{dip}	-	-	-
U _{swf}	-	-	-
U _{tr}	-	-	-
U _{int}	-	-	-
U _{nba}	-	-	-
U _{nb}	-	-	-
U _h	-	-	-
I _h	-	-	-
Msv	-	-	-

7.COMMUNICATION

RS485 Wirina diagram:

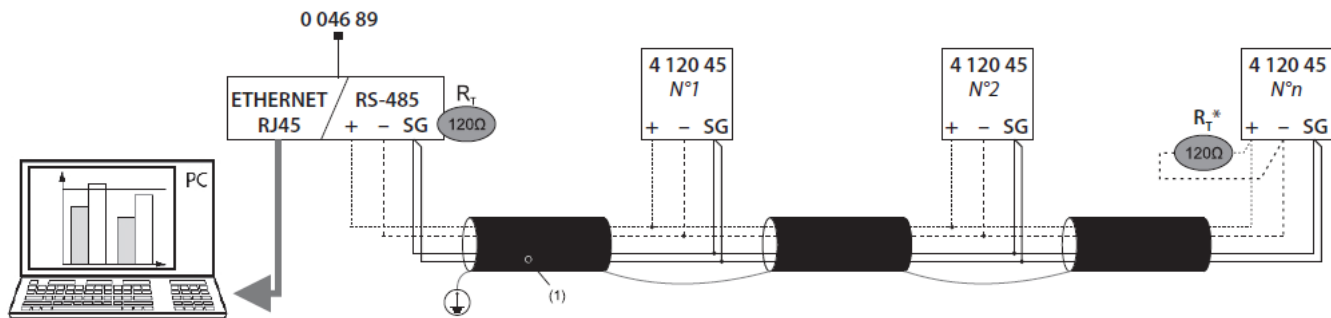

(1) RS485: Prescribed use of Cable Belden 9842, Belden 3106A (or equivalent) for a maximum length of 1000 m, or Category 6 cable (FTP or UTP) for a maximum length of 50 m;
(*Resistance not furnished

Modbus communication tables

. Modbus communication tables are available at <http://ecatalogue-export.legrand.com>, typing "4 120 45" in the search field