

Céliane™

Plaques finition Poudré

Référence(s) : 0 667 01/02/03/04/05/06/08/09/11/12/13/14/15/16/18/19
0 667 21/22/23/24/25/26/28/29/31/32/33/34/35/36/38/39
0 667 40/41/42/43/44/45/46/48/49/51
0 667 52/53/54/61/62/63/64/71/72/73

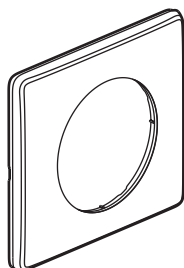

0 667 01/11/21/31/40/41/51/61/71

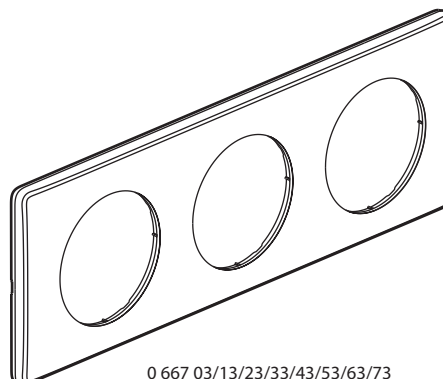

0 667 03/13/23/33/43/53/63/73

1. USAGE

Plaques permettant l'habillage de mécanismes de 1 à 4 postes.
Montage horizontal ou vertical.

2. GAMME



Plaques 1 poste

	 Craie	0 667 01
	 Argile	0 667 11
	 Grès	0 667 21
	 Schiste	0 667 31
	 Eclipse	0 667 40
	 Basalte	0 667 41
	 Bordeaux	0 667 51
	 Vieux Rose	0 667 61
	 Bleu Vert	0 667 71

Plaques 2 postes - Entraxe 71 mm

	 Craie	0 667 02
	 Argile	0 667 12
	 Grès	0 667 22
	 Schiste	0 667 32
	 Basalte	0 667 42
	 Bordeaux	0 667 52
	 Vieux Rose	0 667 62
	 Bleu Vert	0 667 72

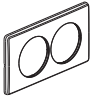
Plaques 2 postes - Entraxe 57 mm







	 Craie	0 667 08
	 Argile	0 667 18
	 Grès	0 667 28
	 Schiste	0 667 38
	 Basalte	0 667 48

Plaques 2 postes étendue

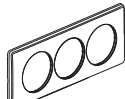





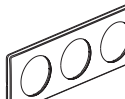

	 Craie	0 667 05
	 Argile	0 667 15
	 Grès	0 667 25
	 Schiste	0 667 35
	 Basalte	0 667 45

2. GAMME (suite)







Plaques 3 postes - Entraxe 57 mm

	 Craie	0 667 09
	 Argile	0 667 19
	 Grès	0 667 29
	 Schiste	0 667 39
	 Basalte	0 667 49







Plaques 3 postes - Entraxe 71 mm

	 Craie	0 667 03
	 Argile	0 667 13
	 Grès	0 667 23
	 Schiste	0 667 33
	 Basalte	0 667 43
	 Bordeaux	0 667 53
	 Bleu Vert	0 667 63

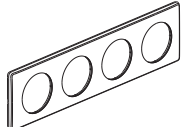
Plaques 3 postes étendue

	 Craie	0 667 06
	 Argile	0 667 16
	 Grès	0 667 26
	 Schiste	0 667 36
	 Basalte	0 667 46

Plaques 4 postes - Entraxe 71 mm

	 Craie	0 667 04
	 Argile	0 667 14
	 Grès	0 667 24
	 Schiste	0 667 34
	 Basalte	0 667 44
	 Bordeaux	0 667 54
	 Vieux Rose	0 667 64

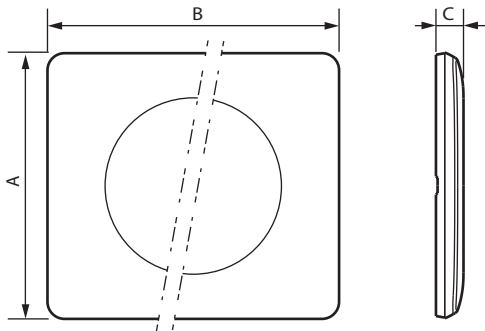
3. DIMENSIONS (mm)

Références	A	B	C
0 667 01/11/21/31/40/41/51/61/71	82	90	8,5
0 667 02/12/22/32/42/52/62/72	82	161	8,5
0 667 05/15/25/35/45	82	161	8,5
0 667 03/13/23/33/43/53/63/73	82	232	8,5
0 667 06/16/26/36/46	82	232	8,5
0 667 04/14/24/34/44/54/64	82	303	8,5
0 667 08/18/28/38/48	82	147	8,5
0 667 09/19/29/39/49	82	204	8,5

4. CARACTÉRISTIQUES TECHNIQUES**■ 4.1 Caractéristiques matières**

PC + ABS

Sans halogène

Résistant aux UV

Autoextinguibilité : 650° C/30 s

■ 4.2 Caractéristiques climatiques

Température de stockage : - 10° C à + 70° C

Températures d'utilisation : - 5° C à + 50° C

5. ENTRETIEN

Nettoyage superficiel au chiffon.

Ne pas utiliser : acétone, dégraissant, trichloréthylène.

Tenue aux produits suivants : Hexane (EN 60669-1), Alcool à brûler, Eau savonneuse, Ammoniac dilué, Javel pure diluée à 10%, Produit à vitres, Lingettes pré-imprégnées.

Attention : Pour l'utilisation de produits d'entretien spécifiques autres, un essai préalable est nécessaire.

6. UTILISATION PARTICULIERE

Aucune peinture ne doit être appliquée sur les plaques.