

DPX³ 1600 electronic circuit breakers

Reference(s) : from 422 298 to 422 48 and
from 422 538 to 422 584



CONTENTS

	PAGES
1. USE	1
2. RANGE	1
3. DIMENSIONS AND WEIGHTS	1
4. OVERVIEW	2
5. ELECTRICAL CONNECTIONS	2
6. ELECTR. AND MECH- CHARACTERISTICS	4
7. ELECTRONIC PROTECTION UNIT	5
8. CONFORMITY	8
9. EQUIPMENTS AND ACCESSORIES	9
10. CURVES	12

1. USE

DPX³ platform, for premium segment, is able to cover extended ranges in terms of breaking capacities and rated currents, make protection suitable for different levels of power involved in installations.

DPX³ platform provide easy assembly procedures during the phase of installation and mounting of accessories, suitable for professional use.

2. RANGE

Circuit breaker

I _n (A)	S1 36kA		S2 36kA		S2 + measure 36kA		Sg 36kA		Sg + measure 36kA	
	3P	4P	3P	4P	3P	4P	3P	4P	3P	4P
500	422538	422544	422298	422304	422346	422352	422394	422400	422442	422448
630	422539	422545	422299	422305	422347	422353	422395	422401	422443	422449
800	422540	422546	422300	422306	422348	422354	422396	422402	422444	422450
1000	422541	422547	422301	422307	422349	422355	422397	422403	422445	422451
1250	422542	422548	422302	422308	422350	422356	422398	422404	422446	422452
1600	422543	422549	422303	422309	422351	422357	422399	422405	422447	422453
I _n (A)	50kA		50kA		50kA		50kA		50kA	
	3P	4P	3P	4P	3P	4P	3P	4P	3P	4P
500	422550	422556	422310	422316	422358	422364	422406	422412	422454	422460
630	422551	422557	422311	422317	422359	422365	422407	422413	422455	422461
800	422552	422558	422312	422318	422360	422366	422408	422414	422456	422462
1000	422553	422559	422313	422319	422361	422367	422409	422415	422457	422463
1250	422554	422560	422314	422320	422362	422368	422410	422416	422458	422464
1600	422555	422561	422315	422321	422363	422369	422411	422417	422459	422465
I _n (A)	70kA		70kA		70kA		70kA		70kA	
	3P	4P	3P	4P	3P	4P	3P	4P	3P	4P
500	422562	422568	422322	422328	422370	422376	422418	422424	422466	422472
630	422563	422569	422323	422329	422371	422377	422419	422425	422467	422473
800	422564	422570	422324	422330	422372	422378	422420	422426	422468	422474
1000	422565	422571	422325	422331	422373	422379	422421	422427	422469	422475
1250	422566	422572	422326	422332	422374	422380	422422	422428	422470	422476
1600	422567	422573	422327	422333	422375	422381	422423	422429	422471	422477
I _n (A)	100kA		100kA		100kA		100kA		100kA	
	3P	4P	3P	4P	3P	4P	3P	4P	3P	4P
500	422574	422580	422334	422340	422382	422388	422430	422436	422478	422484
630	422575	422581	422335	422341	422383	422389	422431	422437	422479	422485
800	422576	422582	422336	422342	422384	422390	422432	422438	422480	422486
1000	422577	422583	422337	422343	422385	422391	422433	422439	422481	422487
1250	422578	422584	422338	422344	422386	422392	422434	422440	422482	422488

3. DIMENSIONS AND WEIGHTS

3.1 Dimensions

Implantation

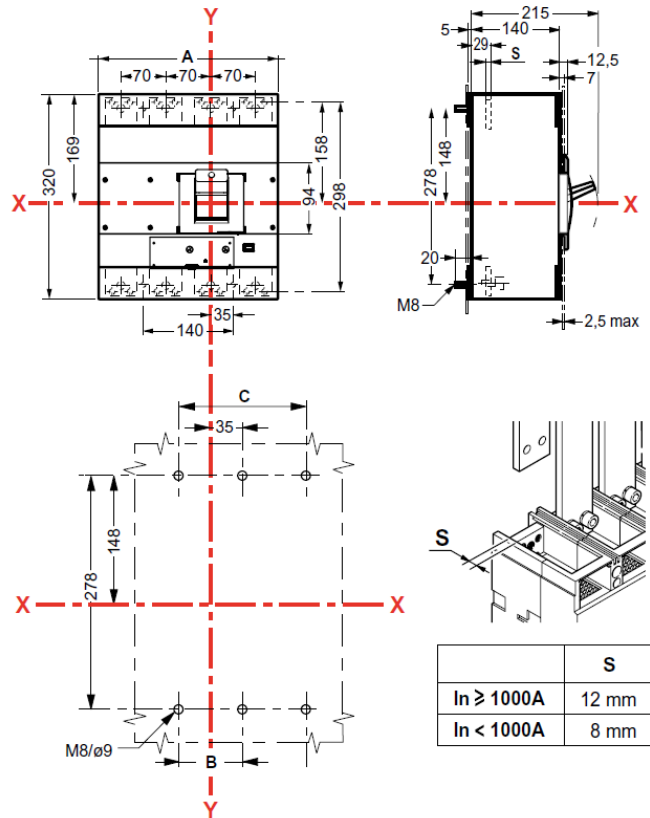

DPX³ 1600 electronic circuit breakers

Reference(s) : from 422 298 to 422 48 and
from 422 538 to 422 584

Front terminals, fixed version

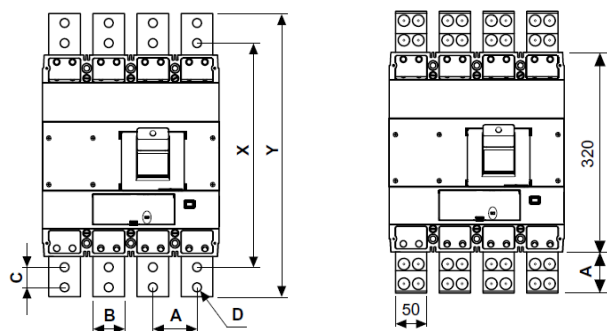
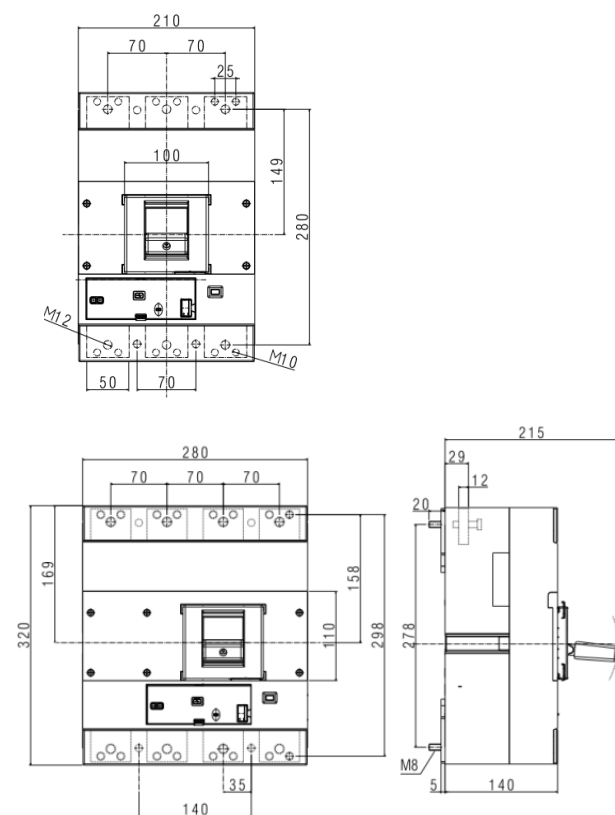

	A	B	C	D	X	Y
	70	50	32	14	358	452
	125	100	25	14,5	544	624

	1,5	63

Side view, flat rear terminals

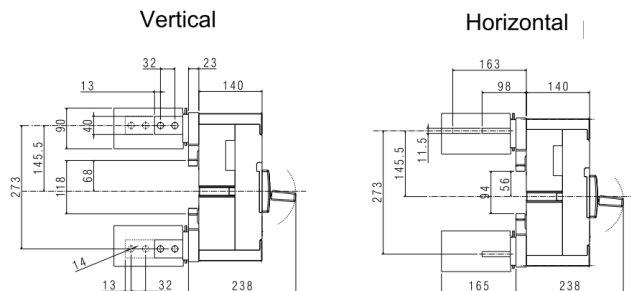

Draw-out version, rear terminals

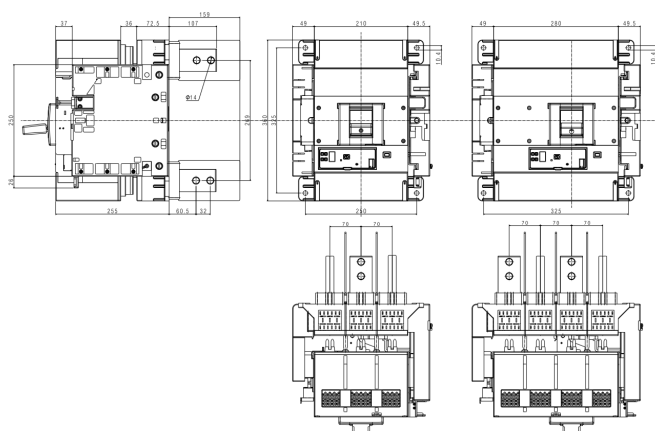

3.2 Weights

Configuration	Weights (Kg)			
	3P		4P	
	$I_n \leq 1250A$	$I_n = 1600A$	$I_n \leq 1250A$	$I_n = 1600A$
Circuit breaker (fixed version)	16	17	20	21.5
Draw-out base (with front terminals)*	18	18	22	22
Draw-out base (with rear terminals)*	21.7	21.7	26.2	26.2
Draw-out debro-lift mechanism *	9.9	9.9	11.2	11.2

* to add to fixed version

4. OVERVIEW

4.1 Supplied with:

- fixing screws (4 for 3P and 4P)
- screws for connections (6 for 3P and 8 for 4P)
- phase insulators (2 for 3P and 3 for 4P)

5. ELECTRICAL CONNECTIONS

5.1 Mounting possibilities

On plate:

- Vertical
- Horizontal
- Supply inverter type

5.2 Mounting

(see instruction sheet for detailed mounting procedures)

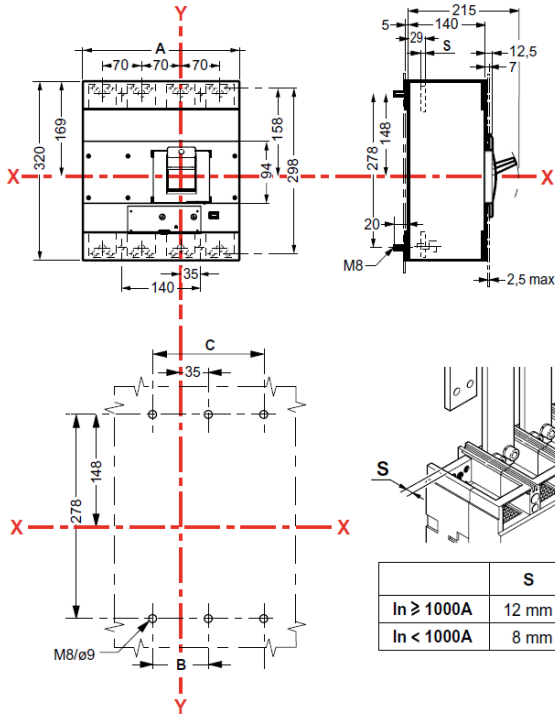

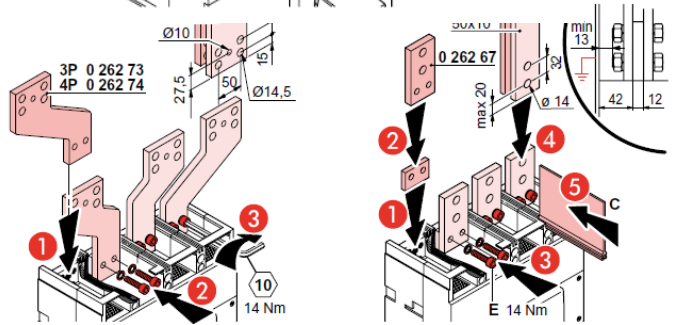
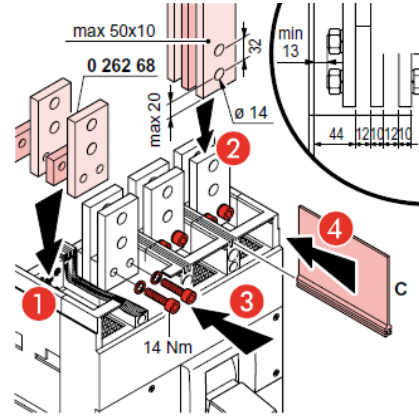
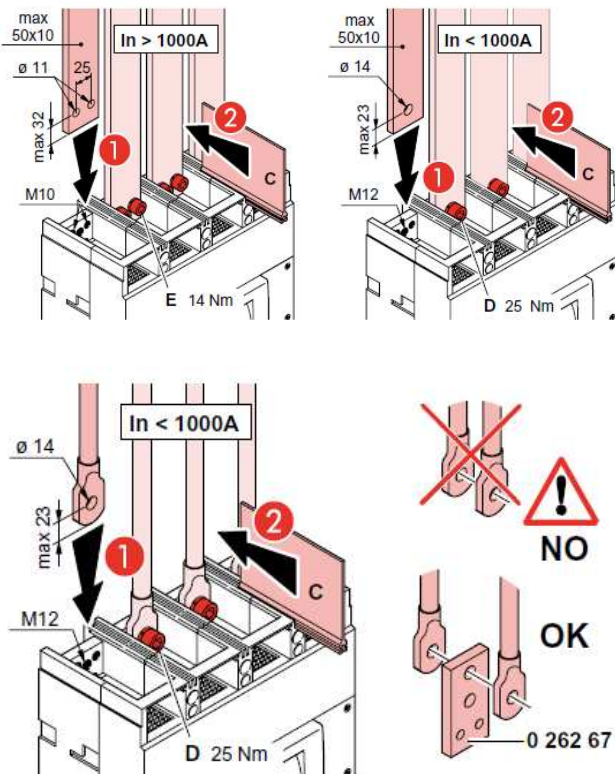

Busbars/cable lugs:

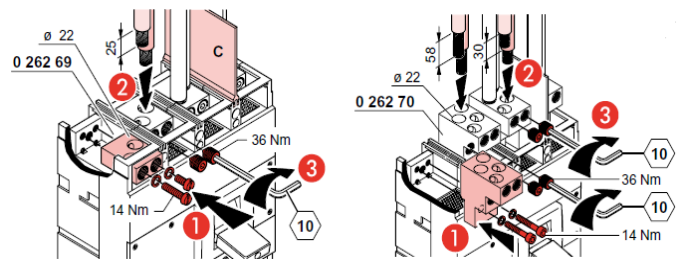

Cables:



Flexible Conductors		2x95mm ² 4x95mm ²	MIN	2x185mm ² 4x185mm ²	MAX
Rigid Conductors		2x120mm ² 4x120mm ²	MIN	2x240mm ² 4x240mm ²	MAX

6. ELECTRICAL AND MECHANICAL CHARACTERISTICS

Circuit Breaker	DPX ³ 1600 TM F/N/H/L (36kA, 50kA, 70kA, 100kA)
Rated current (A)	500, 630, 800, 1000, 1250, 1600
Poles	3 - 4
Pole pitch (mm)	70
Rated insulation voltage (50/60Hz) U _i (V)	1000
Rated operating voltage (50/60Hz) U _o (V)	690
Rated impulse withstand current U _{imp}	8
Rated frequency (Hz)	50 - 60
Operating temperature (°C)	-25 + 70
Mechanical endurance (cycles)	10000
Mechanical endurance with motor control	5000
Electrical endurance at I _n (cycles)	4000
Electrical endurance at 0.5 I _n (cycles)	8000
Utilization category	B
Suitable for isolation	Yes
Type of protection	Electronic
Thermal type protection	Adjustable
Thermal adjustment I _t [x I _n]	0.4 ÷ 1
Thermal adjustment t _r [s]	3-5-10-15-20-25-30
Thermal time tripping at 2xI _n (single pole) [s]	33s±20% if t _r = 3s@12lr
Magnetic type protection	Adjustable
Magnetic adjustment I _{sd} [x I _t]	1.5 + 10
Time adjustment t _{sd} (t=k o P't=k) [s]	0-0.1-0.2-0.3-0.4-0.5
Minimum release single pole	1.2 I _{sd}
Istantaneous electronic adjustment I _i	15 kA (I _n ≤ 1250A); 20kA (I _n = 1600A)
Neutral protection for 4P (%I _n of phase pole)	100
Dimensions (W x H x D) (mm)	210(3P)/280 (4P) x 320x 140

The maximum admissible (absolute) temperature is 125°C
(for detail, see IEC 60947-1 and 60947-2)

DPX³ product line has the possibility to supply both in "direct" and "reverse" feed.

If "direct", the word "LINE" needs to be marked on supply terminals (normally the top ones), as well as "LOAD" has to be written on the output terminals to be connected to the load (normally the bottom ones).

If "reverse", any indications about LINE / LOAD are NOT expected on the product.

6.1 Breaking capacity (kA)

	U _d /I _{cu} (I _{cu} letter)	Breaking capacity (kA) & I _{cs}				
		3P-4P				
IEC 60947-2	220/240 V AC	70	100	105	150	
	380/415 V AC	36	50	70	100	
	440/460 V AC	30	45	65	80	
	480/500 V AC	25	35	45	55	
	480/550 V AC	20	24	28	30	
	600 V AC	20	24	28	30	
	690V AC	14	20	22	25	
	I _{cs} (% I _{cu})	100	100	100	70	
	Rated making capacity under short circuit I _{cm}					
	I _{cm} (kA) at 415V	76.5	105	154	220	
NEMA AB-1	220/240 V AC	70	100	105	150	
	480/500 V AC	25	35	45	55	
	690 V AC	14	20	22	25	

6.3 Rated current (I_n) at 40°C / 50°C

I _n (A)	Phases limit trip current			
	thermal (I _t)		magnetic (I _i)	
	0.4 x I _n	1 x I _n	1.5 x I _t	10 x I _t
500	200	500	750	5000
630	252	630	945	6300
800	320	800	1200	8000
1000	400	1000	1500	10000
1250	500	1250	1875	12500
1600	640	1600	2400	16000

* For neutral adjustment, as explained in technical sheet, please consider the values ratios 100% on set currents.

6.3 Load operations

Force on handle	I _n ≤ 400A	I _n ≥ 500A
Opening operation (N)	80	130
Closing operation (N)	180	210
Restore operation (N)	145	200

6.4 Electrodynamic forces

The table below shows an indication of suggested distances to keep between the breaker and the first fixing point of the conductor and bars in order to reduce the effects of the electrodynamic stresses that may be created during a short circuit. In the realization of anchorage system it is recommend the use of isolators suitable for the type of conductor used and the operating voltage.

I _{cc} (kA)	Maximum Distance (mm)
36	350
50	300
70	250
100	200

According to conductor type and bar system (except Legrand bar kits), the choice of the distance to keep is to be calibrated by the installer. Also installer must take into account the weight of the conductors so that this does not affect the electrical junction between the conductor itself and the connection point.

6.5 Power losses per pole under I_n

	Power losses per pole (W)					
	I _n (A)					
	500	630	800	1000	1250	1600
Front terminals - Fixed version	11.6	18.5	29.8	47.6	74.4	65.3
Rear terminals - Fixed version	11.5	18.3	29.4	47.0	73.4	58.9
Front terminals - D-O version	20.0	31.8	51.2	82.0	128.1	112.6
Rear terminals - D-O version	15.0	23.8	38.4	60.0	93.8	97.3

Note: power loss in the table above are referred and measured as described in the standard IEC 60947-2 (Annex G) for circuit-breakers. Values in the table are referred to a single phase.

6.6 DERATINGS

6.6.1 Temperature

Rated current and his adjustment has to be considered relating to a rise or fall of ambient temperature and to a different version or installation conditions. The table below indicates the maximum long-time (LT) protection setting depending on the ambient temperature.

I _n (A)	Temperature Ta (°C)		
	up to 50	60	70
500	500	500	500
630	630	630	630
800	800	800	720
1000	1000	1000	900
1250	1250	1250	938
1600	1600	1600	1360

For derating temperature with other configurations, see table A.

6.6.2 Specific condition use

Climatic conditions

according to IEC/EN 60947-1 Annex Q, Cat. F subject to temperature, humidity, vibration, shock and salt mist.

Electromagnetic disturbances (EMC)

for DPX³ 1600 circuit breakers, according to IEC/EN 60947-2 Annex F

Pollution degree

for DPX³ 1600 circuit breakers, degree 3, according to IEC/EN 60947-2

6.6.3 Altitude

Altitude derating for DPX³ a

Altitude (m)	2000	3000	4000	5000
U _e (V)	690	590	520	460
I _n (A) (T _a = 40°C/50°C)	1 x I _n	0.98 x I _n	0.93 x I _n	0.9 x I _n

7. ELECTRONIC PROTECTION UNIT

7.1 Version S1 – Adjustment of I_r, I_{sd}

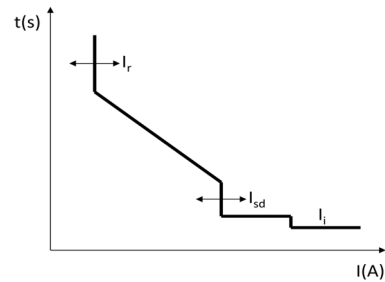
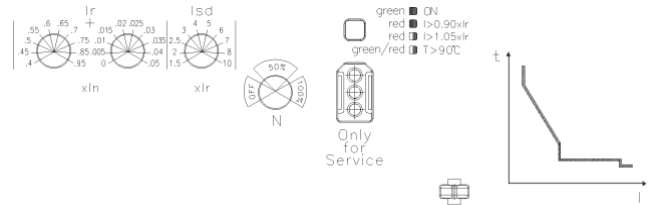

Long delay protection against overloads with an adjustable threshold bases on the RMS value of the current:

- I_r = 0.4 ÷ 1 I_n (steps 1A)

Short delay protection against short-circuits with an adjustable I_{sd} threshold:

- I_{sd} = 1.5 - 2 - 2.5 - 3 - 4 - 5 - 6 - 7 - 8 - 9 - 10 x I_r (11 steps)

Instantaneous protection with fixed threshold:

- 500A I_i = 15kA,
- 630,800A I_i = 15kA,
- 1000A I_i = 15kA,
- 1250A I_i = 15kA,
- 1600A I_i = 20kA

7.2 Version S2 – Adjustment of I_r, T_r, I_{sd}, T_{sd}

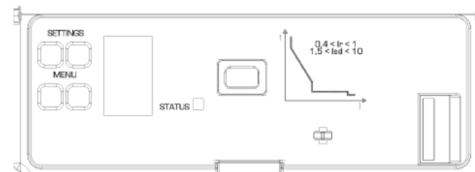

LCD display with adjustment buttons, battery case and USB port.

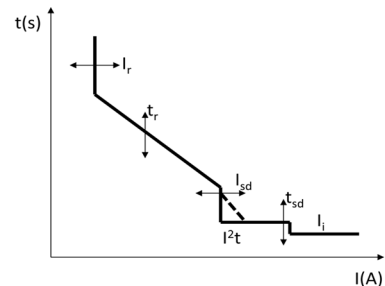

Long delay protection against overloads with an adjustable threshold bases on the RMS value of the current:

- I_r = 0.4 ÷ 1 I_n (steps 1A)
- T_r = 3 - 30s (3 - 5 - 10 - 15 - 20 - 25 - 30) (7 steps)

Short delay protection against short-circuits with an adjustable I_{sd} threshold:

- $I_{sd} = 1.5 - 2 - 2.5 - 3 - 4 - 5 - 6 - 7 - 8 - 9 - 10 \times I_r$ (11 steps)
- $T_{sd} = 0 - 100 - 200 - 300 - 400 - 500$ ms ($I = K$)
- $T_{sd} = 0 - 100 - 200 - 300 - 400 - 500$ ms ($I^2t = K$)

Instantaneous protection with fixed threshold:

- 500A $I_i = 15kA$,
- 630,800A $I_i = 15kA$,
- 1000A $I_i = 15kA$,
- 1250A $I_i = 15kA$,
- 1600A $I_i = 20kA$

7.3 Version Sg - Adjustment of I_r , T_r , I_{sd} , T_{sd} , I_g , T_g

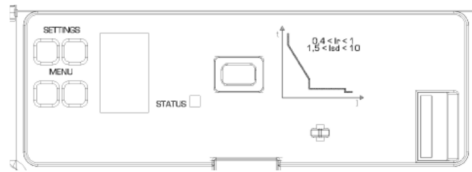

LCD display with adjustment buttons, battery case and USB port.

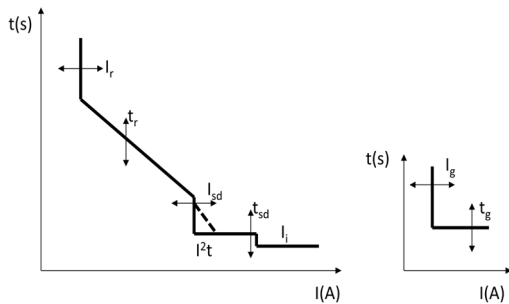

Long delay protection against overloads with an adjustable threshold bases on the RMS value of the current:

- $I_r = 0.4 \div 1 I_n$ (steps 1A)
- $T_r = 3 - 30s$ (3 - 5 - 10 - 15 - 20 - 25 - 30) (7 steps)

Short delay protection against short-circuits with an adjustable I_{sd} threshold :

- $I_{sd} = 1.5 - 2 - 2.5 - 3 - 4 - 5 - 6 - 7 - 8 - 9 - 10 \times I_r$ (11 steps)
- $T_{sd} = 0 - 100 - 200 - 300 - 400 - 500$ ms ($I = K$)
- $T_{sd} = 0 - 100 - 200 - 300 - 400 - 500$ ms ($I^2t = K$)

Instantaneous protection with fixed threshold:

- 500A $I_i = 15kA$,
- 630,800A $I_i = 15kA$,
- 1000A $I_i = 15kA$,
- 1250A $I_i = 15kA$,
- 1600A $I_i = 20kA$

Measure of ground fault:

- $I_g : 0.2 - 0.3 - 0.4 - 0.5 - 0.6 - 0.7 - 0.8 - 0.9 - 1 \times I_n$ (9 steps) and OFF
- $T_g : 0.1 - 0.2 - 0.3 - 0.4 - 0.5 - 1$ s

Together with above protections, activated in case of electric faults, the trip unit also integrates self-protection for:

- Over temperature : in case the internal temperature of protection unit exceed 95°C;
- Auto diagnostics: in case embedded watchdog circuit detects internal malfunctions, which could compromise the correct working of microcontroller.

General remarks on protection unit

The protection units S1/S2/Sg are normally supplied by the internal current transformers (CTs).

When the current flowing through the circuit breaker is greater than 12% of the maximum power (20% of I_n for single phase load), the internal current supply ensures all operation of the protection unit, included LED status, display indications(*) and diagnostic functions (e.g. trip test).

(*)Display backlight and integrated measure (if available) are instead guaranteed starting from 20% of the maximum power (35% of I_n for single phase load), in absence of any other supply. In any case the external power supply is strongly recommended for the correct working of measurement, as well as RS485 communication.

To ensure the same performance when the load is less than 12% of the maximum power (20% of I_n for single phase load) to grant complete functions, one of the following optional power supplies can be used:

- (*)external Auxiliary power supplier or, alternatively, Modbus communication interface.
- (*)power supply temporarily connected to frontal USB socket, connected to a 5V DC power bank or PC.
- (**)power supply temporarily connected to frontal Service port, connected to specific adapter for PC (Legrand use only)

(*) available only for S2/Sg versions

(**) available only for S1 versions

In the electronic unit protection type S2/Sg, an energy metering central unit, if available, is integrated.

The possible parameters that can be measured are listed in the following table:

Measured	UNIT	DESCRIPTION
I_1	A	L1 realtime measured value
I_2	A	L2 realtime measured value
I_3	A	L3 realtime measured value
I_N (4P)	A	N realtime measured value
I_G	A	G realtime measured value
$U_{12} U_{23} U_{31}$ (3P)	V	Phase to Phase Voltage
$V_{12} V_{23} V_{31}$ (4P)	V	Voltage
Freq.	Hz	Frequency
P_{Tot}	kW	Active Power
Q_{Tot}	kvar	Reactive Power
PF		Power Factor
$E_p \downarrow$	kWh	Consumed active energy
$E_p \uparrow$	kWh	Returned active energy
$E_q \downarrow$	kvar h	Consumed reactive energy
$E_q \uparrow$	Kvar h	Returned reactive energy
$THDU_{12}/THDU_{23}/THDU_{31}$ (3P)	%	Chained Voltage THD
$THDV_{1N}/THDV_{2N}/THDV_{3N}$ (4P)	%	Voltage THD
$THDI_1/THDI_2/THDI_3/THDI_N$	%	Current THD
MEM	A - °C	Cause of the last intervention and its value

Function performance class according to IEC 61557-12

Function symbol	Performance class	Measurement range					Other complementary characteristics				
		DPX ³ 1600A					I_{max} PMD				
I_n		630A	800A	1000A	1250A	1600A	630A	800A	1000A	1250A	1600A
P	1	0.5kW	0.5kW	0.5kW	0.5kW	0.5kW	750A	960A	1200A	1500A	1920A
		900kW	1.15MW	1.4MW	1.8MW	2.3MW	$I_b=400A, U_n=400V, f_r=50Hz$				
QA, Qv	2	0.5kvar	0.5kvar	0.5kvar	0.5kvar	0.5kvar	750A	960A	1200A	1500A	1920A
		900kW	1.15MW	1.4MW	1.8MW	2.3MW	$I_b=250A, U_n=400V, f_r=50Hz$				
E_a	1	0...999 GW/h					750A	960A	1200A	1500A	1920A
							$I_b=400A, U_n=400V, f_r=50Hz$				
ERA, E_{rV}	2	0...999 GW/h					750A	960A	1200A	1500A	1920A
							$I_b=400A, U_n=400V, f_r=50Hz$				
f	0.02	50...60 Hz					-				
I	1	20A	20A	20A	20A	20A	750A	960A	1200A	1500A	1920A
		750A	950A	1200A	1500A	1950A	$I_b=400A, U_n=400V, f_r=50Hz$				
I_N	1	20A	20A	20A	20A	20A	750A	960A	1200A	1500A	1920A
		750A	950A	1200A	1500A	1950A	$I_b=400A, U_n=400V, f_r=50Hz$				
U	0.5	88...690V					-				
P_{FA}	0.5	-					750A	960A	1200A	1500A	1920A
							$I_b=400A, U_n=400V, f_r=50Hz$				
THDu	5	110...690V					-				
THDi	5	400A	400A	400A	400A	400A	-				
		630A	800A	1000A	1250A	1600A					

8. CONFORMITY

DPX³ range of product concerning circuit-breakers exceed compliance with the EN/IEC standard 60947-2 and 60947-3 respectively.

Certification available by IECEE CB-scheme or LOVAG Compliance scheme.

Marks as CCC (China), EAC (Eurasian Federation) or different local certification are available.

DPX³ are in conformity with the Lloyds Shipping Register, RINA and Bureau Veritas Marine.

DPX³ respect the European Directives REACH, RoHS, RAEE and Product Environment Product (PEP Ecopassport) are available.

For specific information, please contact Legrand support.

8.1 Marking

Product (both circuit breakers and switch disconnectors) are provided with labelling in full conformity to the referred standard and directives requirements by laser or sticker labels as:

Product laser label on front

- Manufacturer responsible
- Denomination, type product, code
- Standard conformity
- Standard characteristics declared
- coloured identification of I_{cu} at 415V

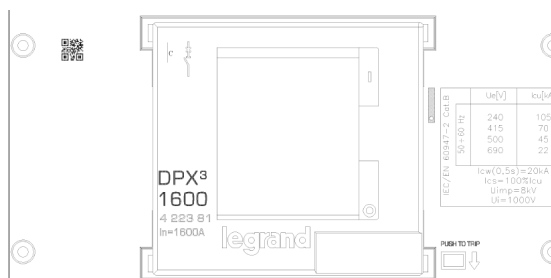

S1 release:

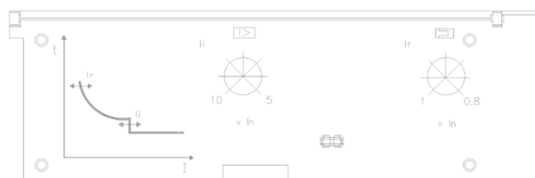

S2/Sg release:

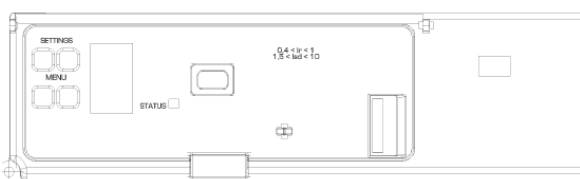

Product sticker label on side

- Manufacturer responsible
- Denomination and type product
- Standard conformity
- Mark/Licence (if any)
- Directive requirements
- bar code identification product
- Manufacturing Country



Mark sticker label on side

- Product code
- Mark/Licence (if any)
- Country deviation, if any

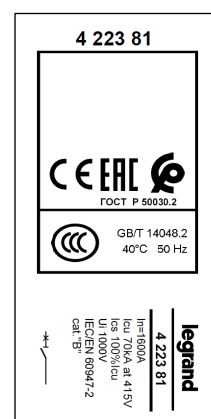

Packaging sticker label

- Manufacturer responsible
- Denomination and type product
- Standard conformity
- Mark/Licence (if any)
- Directive requirements
- bar code identification product

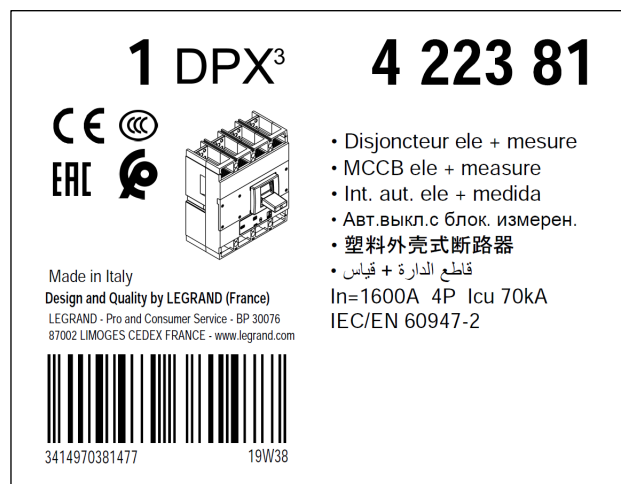

9. EQUIPMENTS AND ACCESSORIES

9.1 Releases (for DPX³ 630 / DPX³ 1600)

- shunt releases with voltage:
 - 24 Vac and dc ref. 4 222 39
 - 48 Vac and dc ref. 4 222 40
 - 110÷130 Vac and dc ref. 4 222 41
 - 220÷250 Vac and dc ref. 4 222 42
 - 380÷440 Vac and dc ref. 4 222 43

Shunt releases electrical characteristics	
Rated voltage (U _c)	Both ac and dc: 24V/48V/110÷130V/220÷250V/380÷440V
Voltage range (%U _c)	70 ÷ 110
Intervention time (ms)	≤ 50
Power consumption (W/VA)	300
Minimum opening time (ms)	50 ms
Insulation voltage (kV)	2,5

- undervoltage releases with voltage:
 - 24 V dc ref. 4 222 44
 - 24 V ac ref. 4 222 45
 - 48 V dc ref. 4 222 46
 - 110 - 125 V ac ref. 4 222 47
 - 220 - 240 V ac ref. 4 222 48
 - 380 - 415 V ac ref. 4 222 49

Undervoltage releases electrical characteristics	
Rated voltage (U _c)	ac: 24V/110÷125V/220÷240V/380÷415V dc: 24V/48V
Voltage range (%U _c)	85 ÷ 110
Minimum opening time (ms)	50
Power consumption (W/VA)	1,6 / 5

- time-lag undervoltage releases (800 ms)
Time-lag modules with voltage:
 - 230 V ac ref. 0 261 90
 - 400 V ac ref. 0 261 91

Universal Release ref. 4 226 23
(to be equipped with a time-lag module 0 261 90/91)

9.2 Auxiliary contacts (for DPX³ 630 / DPX³ 1600)

Changeover switch 3A – 250 VAC ref. 4 210 11

To show the state of the contacts or opening of the DPX³/DPX³ -I on a fault:

- Auxiliary contact (standard) **OC**
- Fault signal **CTR**

Auxiliary contact electrical characteristics		
Rated voltage (V _n)	V (ac or dc)	24 to 250
Intensity (A)	24 V dc	5
	48 V dc	1.7
	110 V dc	0.5
	230 V dc	0.25
	110 V ac	4
	230/250 V ac	3

Configurations:
DPX³ 1600 → 3 auxiliary contacts + 1 fault signal + 1 release

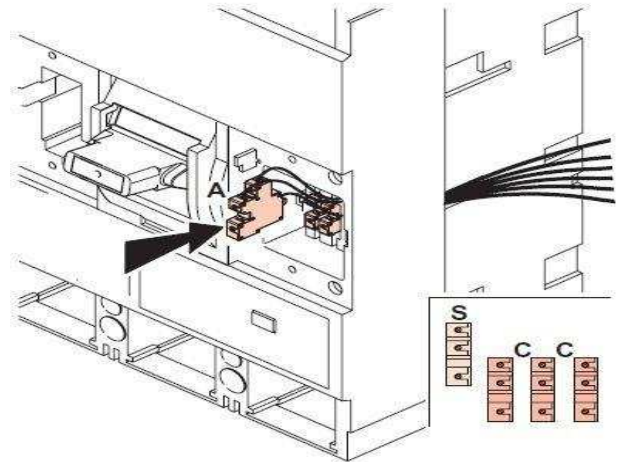

To get more information on auxiliary mounting procedures, please refer to product instruction sheet.

9.3 Universal keylocks

These keylocks must be used for all the accessories that can be locked:

- rotary handle
- motor operator
- plug-in mechanism
- draw-out mechanism

For each of these, a specific accessory (indicated in the specific section of this datasheet) must be added in order to get the complete locking kits for the specific application.

- 1 lock + 1 flat key with random mapping ref. 4 238 80
- 1 lock + 1 flat key with fixed mapping (EL43525) ref. 4 238 81
- 1 lock + 1 flat key with fixed mapping (EL43363) ref. 4 238 82
- 1 lock + 1 star key with random mapping ref. 4 238 83

9.4 Rotary handles

Direct on DPX³ (with auxiliary option)

- Standard (black) ref. 0 262 61

Vari-depth handle IP55 (with auxiliary option)

- Standard (black) ref. 0 262 83
- For emergency use (red / yellow) adapting on standard handle ref. 0 262 84

Locking accessories (for vary-depth handle with auxiliary option)

- Key lock accessory for vari-depth rotary handle ref. 4 228 07

Ref. 4 238 07 must be used with universal keylocks to get the complete locking kit for rotary handle

9.5 Motor-driven handles

Factory assembled

Front operated

- Voltage 230 V AC ref. 0 261 54

Customer assembled

Front operated

- Voltage 24 V AC and DC ($I_n \leq 1250A$) ref. 0 261 24
- Voltage 48 V AC and DC ($I_n \leq 1250A$) ref. 0 261 25
- Voltage 110 V AC and DC ($I_n \leq 1250A$) ref. 0 261 26
- Voltage 220 V AC and DC ($I_n \leq 1250A$) ref. 0 261 23

- Voltage 24 V AC and DC ($I_n = 1600A$) ref. 0 261 19
- Voltage 48 V AC and DC ($I_n = 1600A$) ref. 0 261 28
- Voltage 110 V AC and DC ($I_n = 1600A$) ref. 0 261 29
- Voltage 220 V AC and DC ($I_n = 1600A$) ref. 0 261 27

Locking accessories

- Key lock accessory for motor operator ref. 4 228 06

Ref. 4 228 06 must be used with universal keylocks to get the complete locking kit for motor operator

9.6 Mechanical accessories

Phase insulators

- Set of 3 ref. 0 262 66

Sealable terminal shields

- Set of 2 3P ref. 0 262 64
- Set of 2 4P ref. 0 262 65

Padlock

- Accessories to lock in open position ref. 0 262 60

Terminal covers to guarantee IP20

- Set of 2 3P ref. 4 225 90
- Set of 2 4P ref. 4 225 91
- External neutral ref. 4 225 92

9.7 Connection accessories

Cage terminals

- Set of 4 terminals for cables 2x240mm² max (rigid) or 2x185mm² max (flexible) (Cu/Al) ref. 0 262 69
- Set of 4 terminals for cables 4x240mm² max (rigid) or 4x185mm² max (flexible) (Cu/Al) ref. 0 262 70

Extended front terminals

- Short terminals for 500 - 1250A (2 bars max. per pole) ref. 0 262 67
- Long terminals for 1600A (3 bars max. per pole) ref. 0 262 68

Spreaders

- Set of 3 (incoming or outgoing 3P) ref. 0 262 73
- Set of 4 (incoming or outgoing 4P) ref. 0 262 74

Rear terminals

(use to connect fixed version with front terminals into fixed version with rear terminal)

- Set of swivel terminals, incoming or outgoing
 - 3P ref. 0 263 80
 - 4P ref. 0 263 82
- Set of flat rear terminals, incoming or outgoing
 - 3P ref. 0 263 81
 - 4P ref. 0 263 83

Cage terminal use specifications

DPX ³ 1600							
Type of cage terminal	Cable standard suggested cross section (mm ²)*			Dimensions limits of cable for cage terminals			
	In (A)	Cu	Al	MIN cross section (mm ²)		MAX cross section (mm ²)	
				Flexible	Rigid	Flexible	Rigid
Standard	500	2x150	2x240	95	70	185	240
	630	2x185	\				
	800	2x240	\				
	1000	\	\				
	1250	\	\				
High capacity	500	2x150	2x240	95	70	185	240
	630	2x185	3x240				
	800	2x240	3x240				
	1000	4x150	4x240				
	1250	4x185	\				
	1600	4x240	\				

* The suggested cross section are in compliance with standard IEC60947-1 (ed.6 2020/04) and IEC60947-2 (ed.5.1 2019/07)

9.8 Draw-out version

(A DPX³ draw-out version is a plug-in DPX³ fitted with a "Débro-lift" mechanism which can be used to withdraw the DPX³ while keeping it on its base)

Draw-out base

Base for DPX³ 1600 equipped with "Débro-lift" mechanism

- Front terminals
 - 3P ref. 4 225 86
 - 4P ref. 4 225 87
- Rear terminals
 - 3P ref. 4 225 88
 - 4P ref. 4 225 89

"Débro-lift" mechanism

To be fitted on a DPX³ 1600 fixed version in order to obtain the movable part of a drawout circuit breaker

- Mobile part for draw-out version

3P	ref. 4 225 93
4P	ref. 4 225 94

Key lock for "Débro-lift" mechanism

- One key for DPX³ only
(enable locking in draw - out position)
- Key lock accessory for draw-out (frontal masks for motor operator or rotary handle) ref. 4 228 09
- Key lock accessory for draw-out ref. 4 228 10

Ref. 4 228 09 and 4 228 10 must be used with universal keylocks to get the complete locking kit for draw-out version

Accessories for "Débro-lift" mechanism

- Isolated handle for drawing-out ref 0 265 75
- Signal contact (plugged-in / draw-out) ref 0 265 74
- Set of connectors (8 contacts) ref 0 263 99
- Set of connectors (6 contacts) ref 0 263 19
- Support plate for draw-out version ref 4 225 95
- Automatic auxiliary contacts (12 pin) D/O version ref.4 222 30

9.9 Plate for transfer switches (factory assembled)

(A transfer switch plate is composed of one plate with interlock for 2 devices)

- Plate for breaker or trip-free switch fixed version ref. 0 264 10
- Plate for breaker or trip-free switch plug-in and draw-out version ref. 0 264 05

9.10 Specific accessories for electronic version

Auxiliary power supply

- For supplying electronic units ref. 4 210 83

Is used to supply DPX³ electronic circuit breakers S2/Sg with / without earth leakage module and with / without energy metering central unit. It is mandatory in case of electronic breakers with integrated measure and not interconnected in a supervision system (MODBUS network not requested) to correctly manage the measure functions

Technical characteristics:

- Input voltage: 24V ad/dc (+/- 10%)
- Enclosure: 2 DIN modules
- Output: up to 250mA (to supply many circuit breakers according to the following table):

4 210 83	DPX ³ 250 / 250HP / 630 / 1600	[mA]
$I_{out} MAX = 250 mA$	Electronic/Electronic + RCD (S2/Sg)	50
	Electronic/Electronic + RCD with power metering (S2/Sg)	62.5
	Electronic/Electronic + RCD (S10)	70
	Electronic/Electronic + RCD with power metering (S10)	83

According to single absorptions, it can be possible to connect more than one breaker

MODBUS communication

- RS485 MODBUS communication interface ref. 4 210 75

Is used for sharing on MODBUS network all information managed by DPX³ electronic circuit breakers S2/Sg with / without earth leakage module and with / without energy metering central unit.

Technical characteristics:

- USB local PC connection
- Input voltage: 24V ad/dc (+/- 10%)
- Enclosure: 1 DIN modules
- MODBUS address configuration / transmission mode / transmission speed by physic configurators
- Output relay (220V – 0,2A): to signal tripped position

Consumption: 90mA

It is possible to connect only one breaker to the interface.

In case of use of MODBUS interface 4 210 75, the external power supply module 4 210 83 is not necessary because the external power is already provided by the MODBUS module

DPX³ electronic interface - EMS CX³

- For connecting electronic DPX³ S10 (250HP, 630,1600) to an EMS communication network. All the informations managed by circuit breaker's electronic card will be shared on the EMS network

Dimension: 1 module

Power supply: with EMS CX³ power supply module 4 149 45

Address can be modified and set locally by DIP switches or remotely with the help of the EMS configurator software

ref. 4 238 90

Bluetooth communication key

USB key for BLE communication with electronic DPX³ S10 (250 HP, 630, 1600) to configure, monitor and manage it remotely through App Connection port USB on front of the circuit breaker

ref. 0 283 10

EnerUp + Project App for smartphone and tablet available on Apple Store and Google Play Configuration, monitoring and management software (PCS) available for download via e-catalogue (does not require the use of Bluetooth communication key Ref.0 283 10)

Modular power supply

- 230 V ± - 27 V= - 0.6 A (2 modules) ref. BT-E49

Touch screen

- To show data collected by DX³, DPX³, DMX³, EMDX³. It can manage up to 8 devices ref. 0 261 56

10. CURVES

10.1.1 Long time Tripping curve (S1)

Update: 02/07/2018

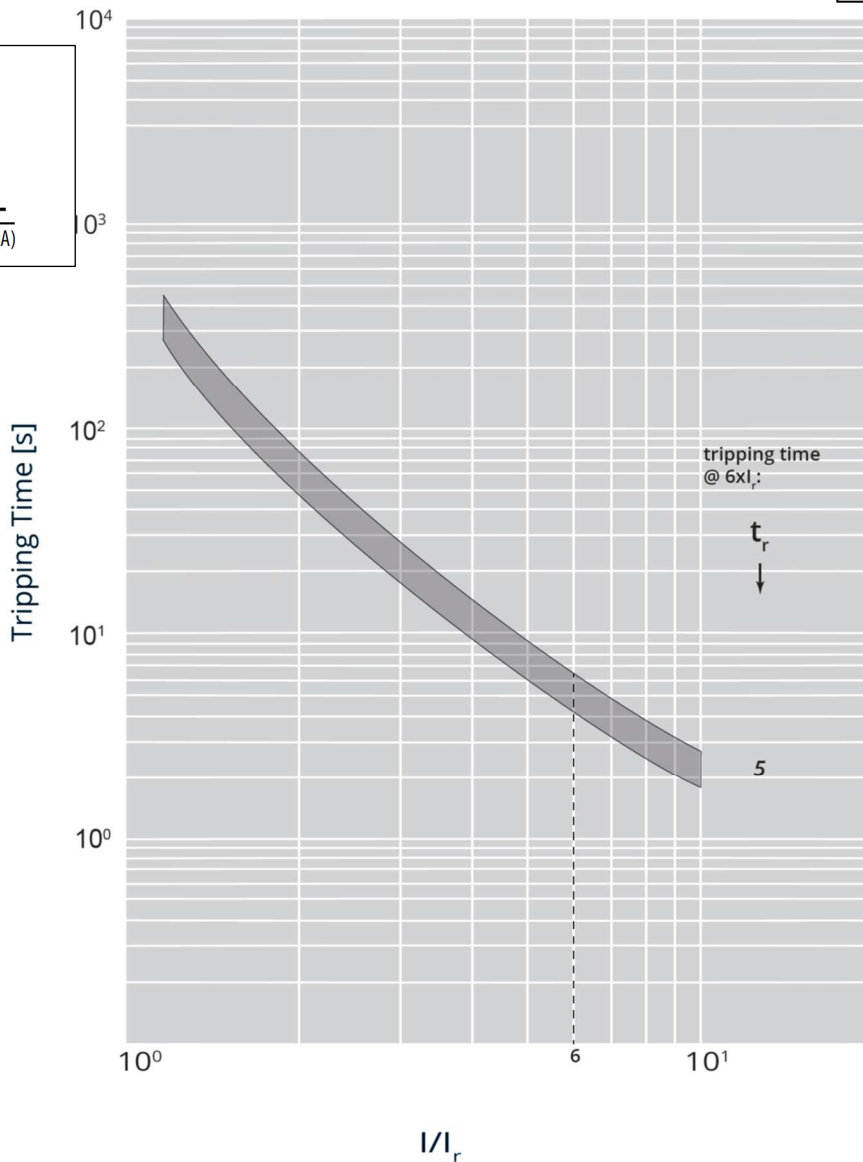
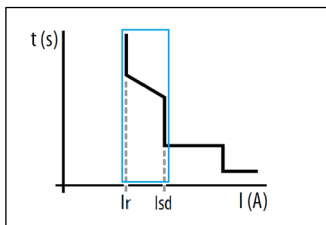

$I_{cu} = 36-50-70-100 \text{ kA}$ $I_{max} = 1600\text{A}$ 3-4 P $U_0 = 415\text{Vac}$ (IEC/EN 60947-2)

Value	Description
t	time
I	current
I_r	long time setting current
t_r	long time delay
I_{sd}	short time setting current
t_{sd}	short time delay
I_i	instantaneous release
I_{cu}	rated ultimate short-circuit breaking capacity
$I^2t = K$	constant pass-through energy setting
$t = K$	constant tripping time setting
—————	long time trip curve
-----	short time trip curve
Current tolerance	10% up to I_{sd} ; 20% up to I_i

10.1.2 Long time Tripping curve (S2-Sg); $t_r = 3-15$

Update: 02/07/2018

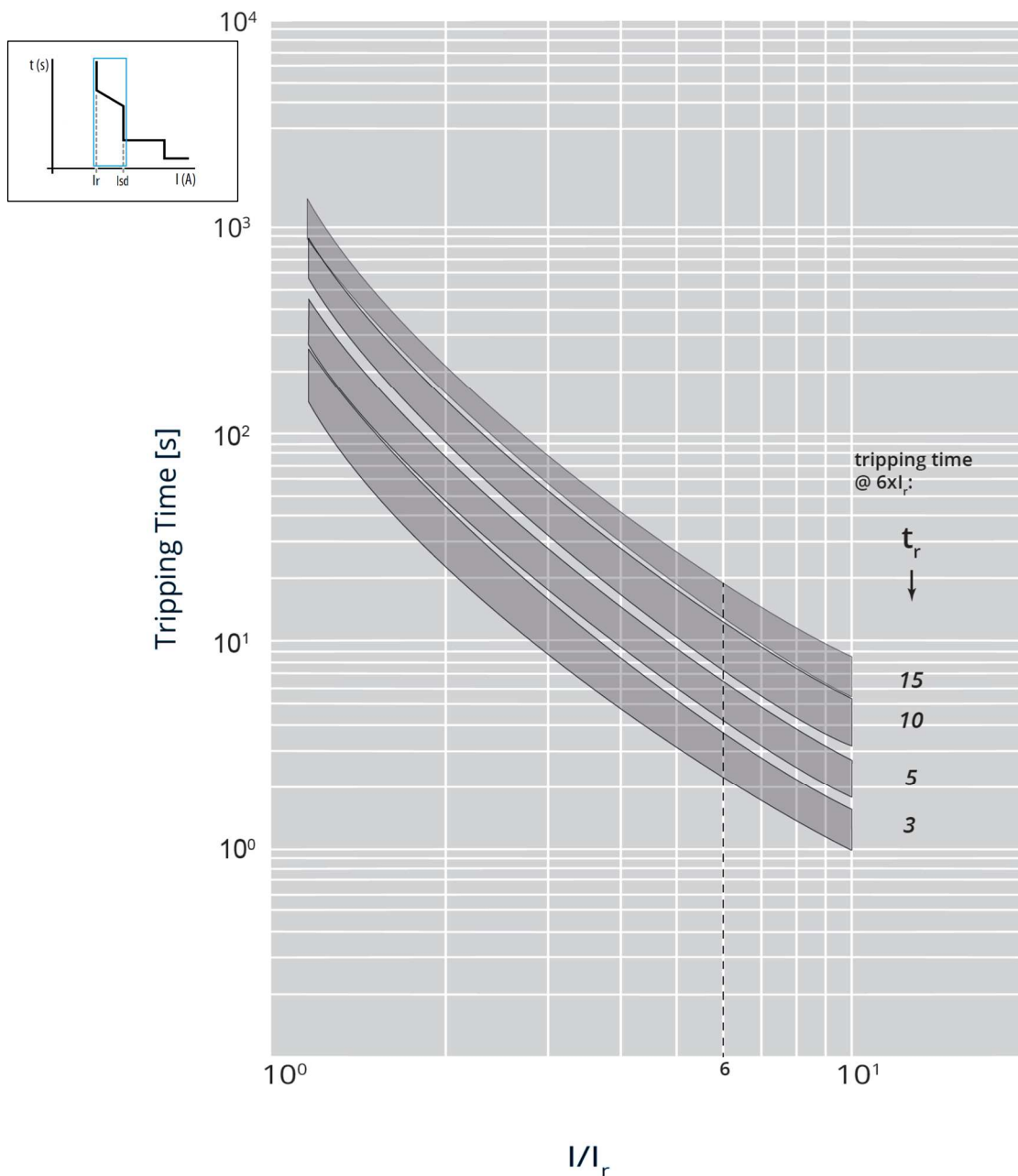

$I_{cu} = 36-50-70-100 \text{ kA}$ $I_{max} = 1600\text{A}$ 3-4 P $U_e = 415\text{Vac}$ (IEC/EN 60947-2)

Value	Description
t	time
I	current
I_r	long time setting current
t_r	long time delay
I_{sd}	short time setting current
t_{sd}	short time delay
I_i	instantaneous release
I_{cu}	rated ultimate short-circuit breaking capacity
$I^2t = K$	constant pass-through energy setting
$t = K$	constant tripping time setting
—————	long time trip curve
-----	short time trip curve
Current tolerance	10% up to I_{sd} ; 20% up to I_i

10.1.3 Long time Tripping curve (S2-Sg) ; $t_r = 20$

Update: 02/07/2018

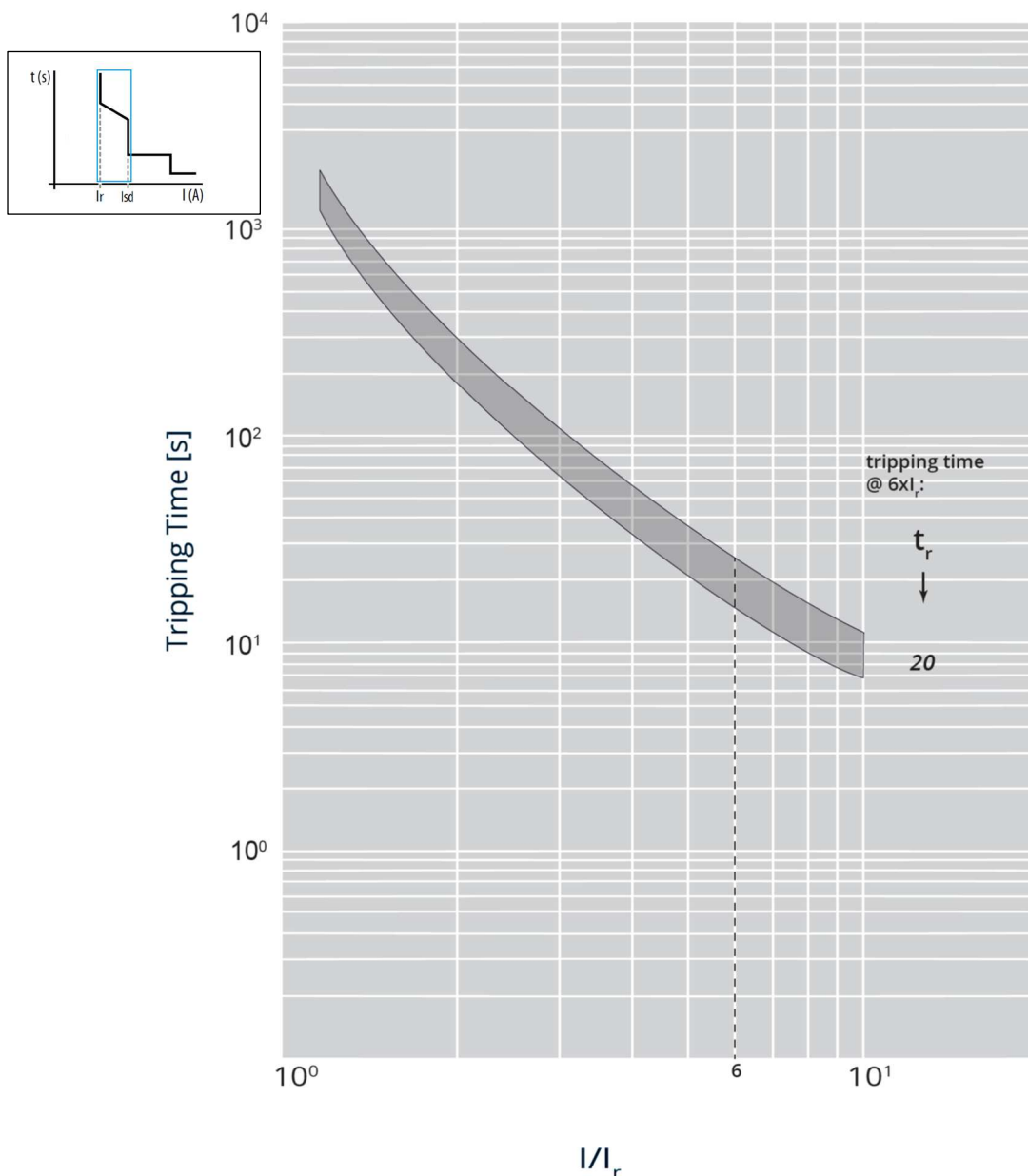

$I_{cu} = 36-50-70-100 \text{ kA}$ $I_{max} = 1600A$ 3-4 P $U_e = 415Vac$ (IEC/EN 60947-2)

Value	Description
t	time
I	current
I_r	long time setting current
t_r	long time delay
I_{sd}	short time setting current
t_{sd}	short time delay
I_i	instantaneous release
I_{cu}	rated ultimate short-circuit breaking capacity
$I^2t = K$	constant pass-through energy setting
$t = K$	constant tripping time setting
—————	long time trip curve
-----	short time trip curve
Current tolerance	10% up to I_{sd} ; 20% up to I_i

10.1.4 Long time Tripping curve (S2-Sg) ; $t_r = 25-30$

Update: 02/07/2018

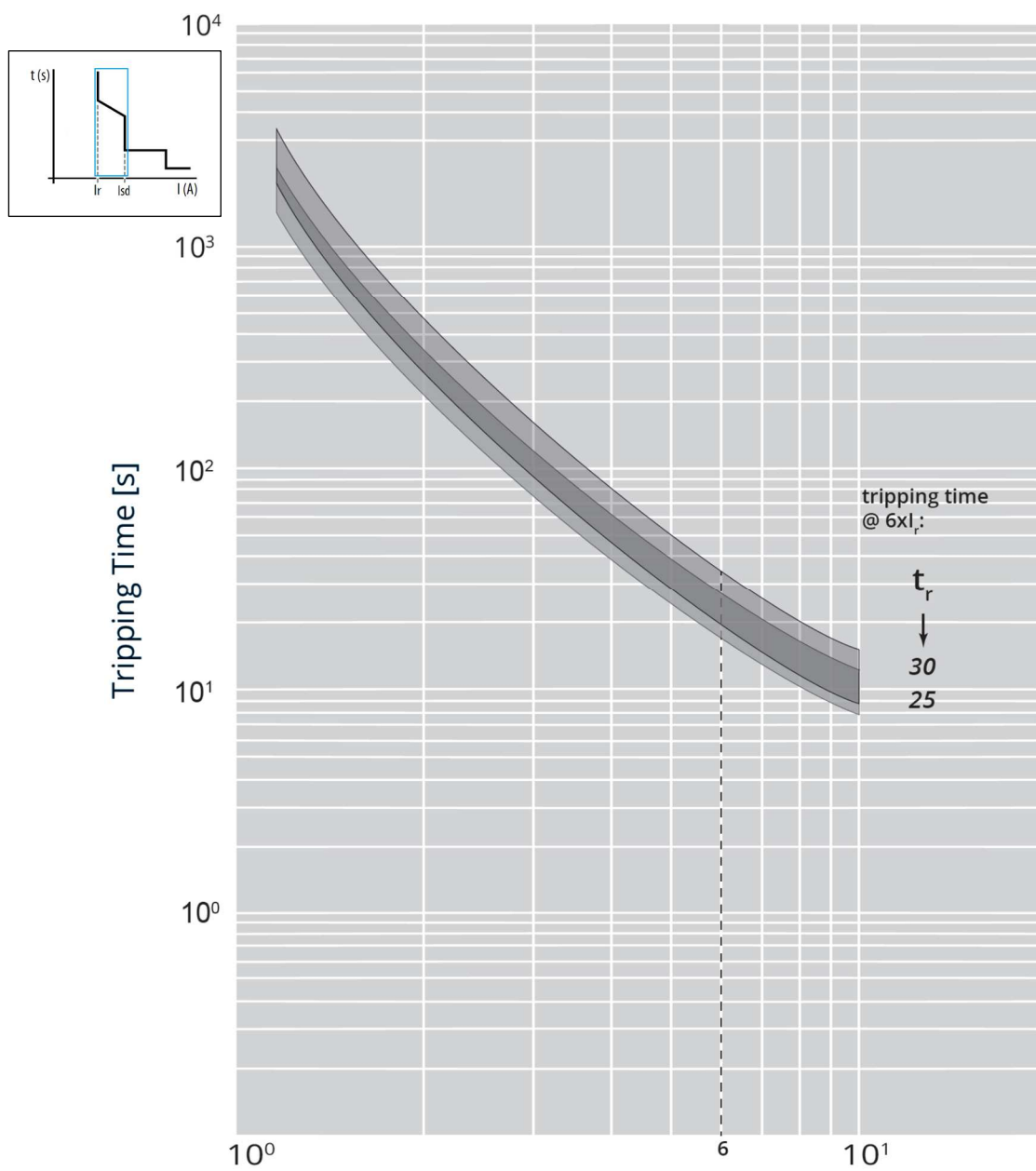

$I_{cu} = 36-50-70-100 \text{ kA}$ $I_{max} = 1600\text{A}$ 3-4 P $U_e = 415\text{Vac}$ (IEC/EN 60947-2)

Value	Description
t	time
I	current
I_r	long time setting current
t_r	long time delay
I_{sd}	short time setting current
t _{sd}	short time delay
I_i	instantaneous release
I_{cu}	rated ultimate short-circuit breaking capacity
$I^2t = K$	constant pass-through energy setting
$t = K$	constant tripping time setting
—————	long time trip curve
-----	short time trip curve
Current tolerance	10% up to I_{sd} ; 20% up to I_i

10.2.1 Short time Tripping curve (S1)

Update: 02/07/2018

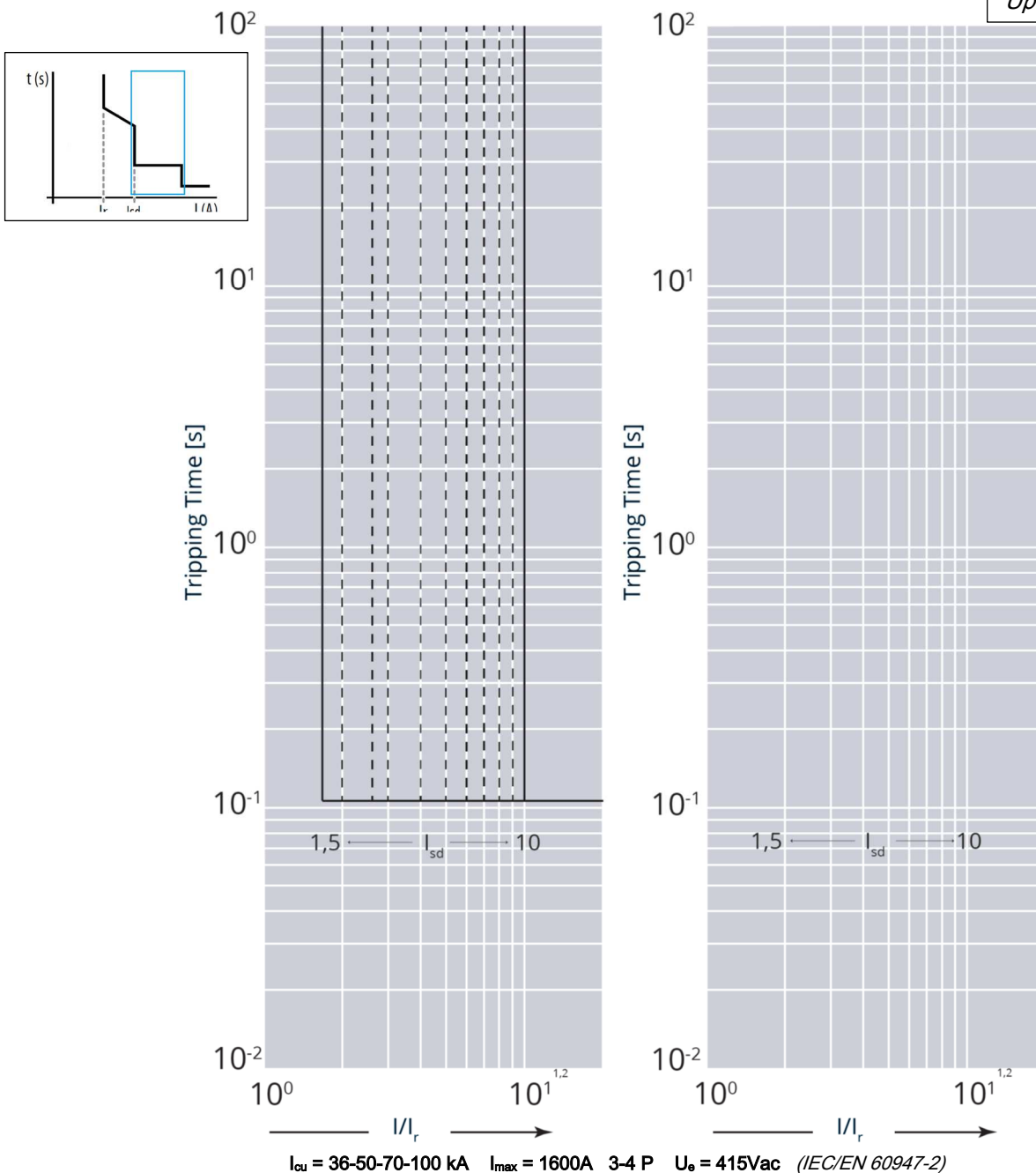

Value	Description
t	time
I	current
I_r	long time setting current
t_r	long time delay
I_{sd}	short time setting current
t_{sd}	short time delay
I_i	instantaneous release
I_{cu}	rated ultimate short-circuit breaking capacity
$I^2t = K$	constant pass-through energy setting
$t = K$	constant tripping time setting
—————	long time trip curve
-----	short time trip curve
Current tolerance	10% up to I_{sd} ; 20% up to I_i

10.2.2 Short time Tripping curve (S2-Sg)

Update: 02/07/2018

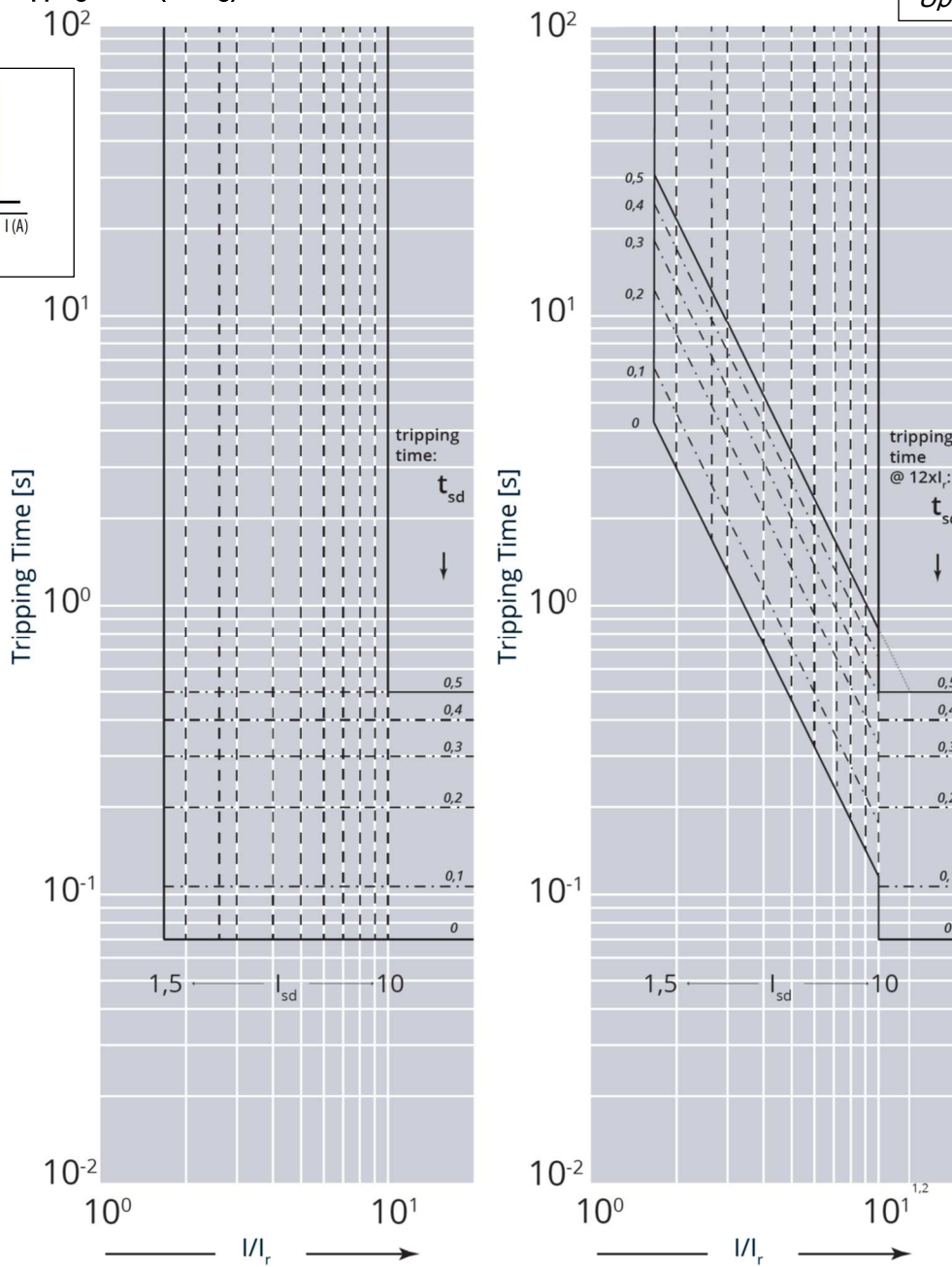
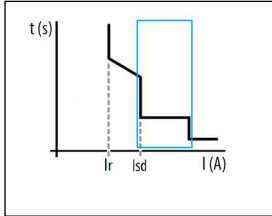

$I_{cu} = 36-50-70-100 \text{ kA}$ $I_{max} = 1600A$ 3-4 P $U_o = 415Vac$ (IEC/EN 60947-2)

Value	Description
t	time
I	current
I_r	long time setting current
t_r	long time delay
I_{sd}	short time setting current
t_{sd}	short time delay
I_i	instantaneous release
I_{cu}	rated ultimate short-circuit breaking capacity
$I^2t = K$	constant pass-through energy setting
$t = K$	constant tripping time setting
—————	long time trip curve
-----	short time trip curve
Current tolerance	10% up to I_{sd} ; 20% up to I_i

10.3.1 Instantaneous time Tripping curve (S1)

Update: 02/07/2018

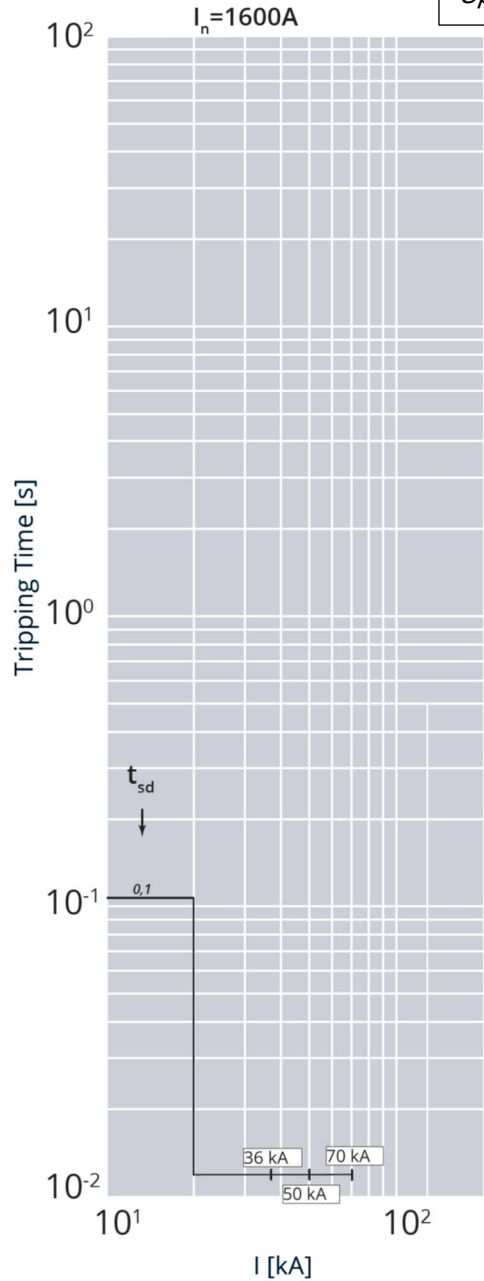
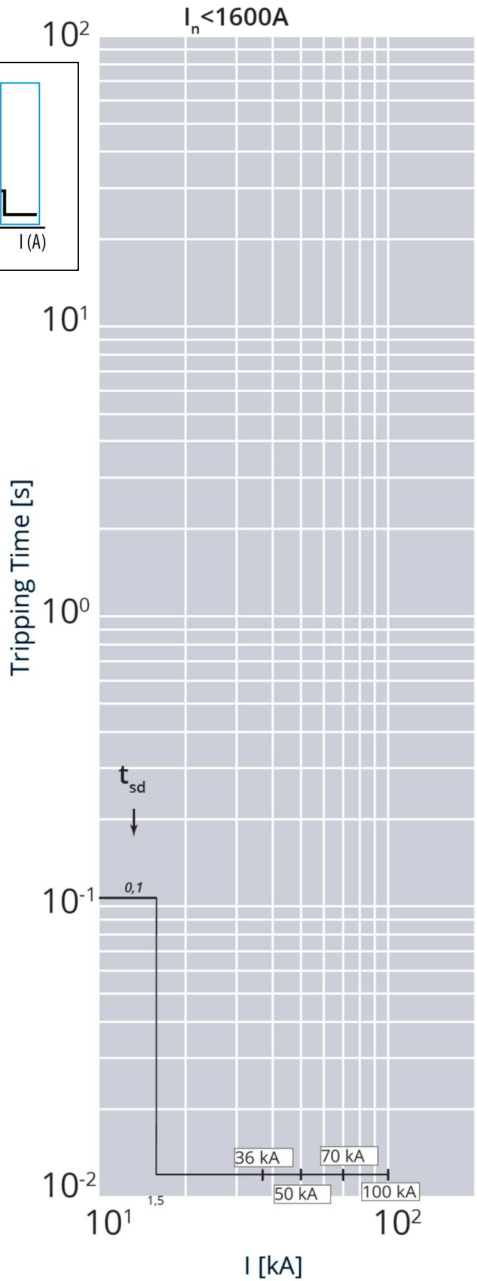
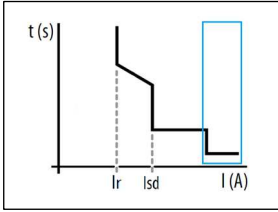

$I_{cu} = 36-50-70-100 \text{ kA}$ $I_{max} = 1600A$ 3-4 P $U_o = 415Vac$ (IEC/EN 60947-2)
Fixed Instantaneous override $I_{sf} = 15kA$ (for $I_n < 1600A$) and $I_{sf} = 20kA$ (for $I_n = 1600A$)

Value	Description
t	time
I	current
I_r	long time setting current
t_r	long time delay
I_{sd}	short time setting current
t_{sd}	short time delay
ii	instantaneous release
I_{cu}	rated ultimate short-circuit breaking capacity
$I^2t = K$	constant pass-through energy setting
$t = K$	constant tripping time setting
-----	long time trip curve
-----	short time trip curve

10.3.2 Instantaneous time Tripping curve (S2-Sg)

Update: 02/07/2018

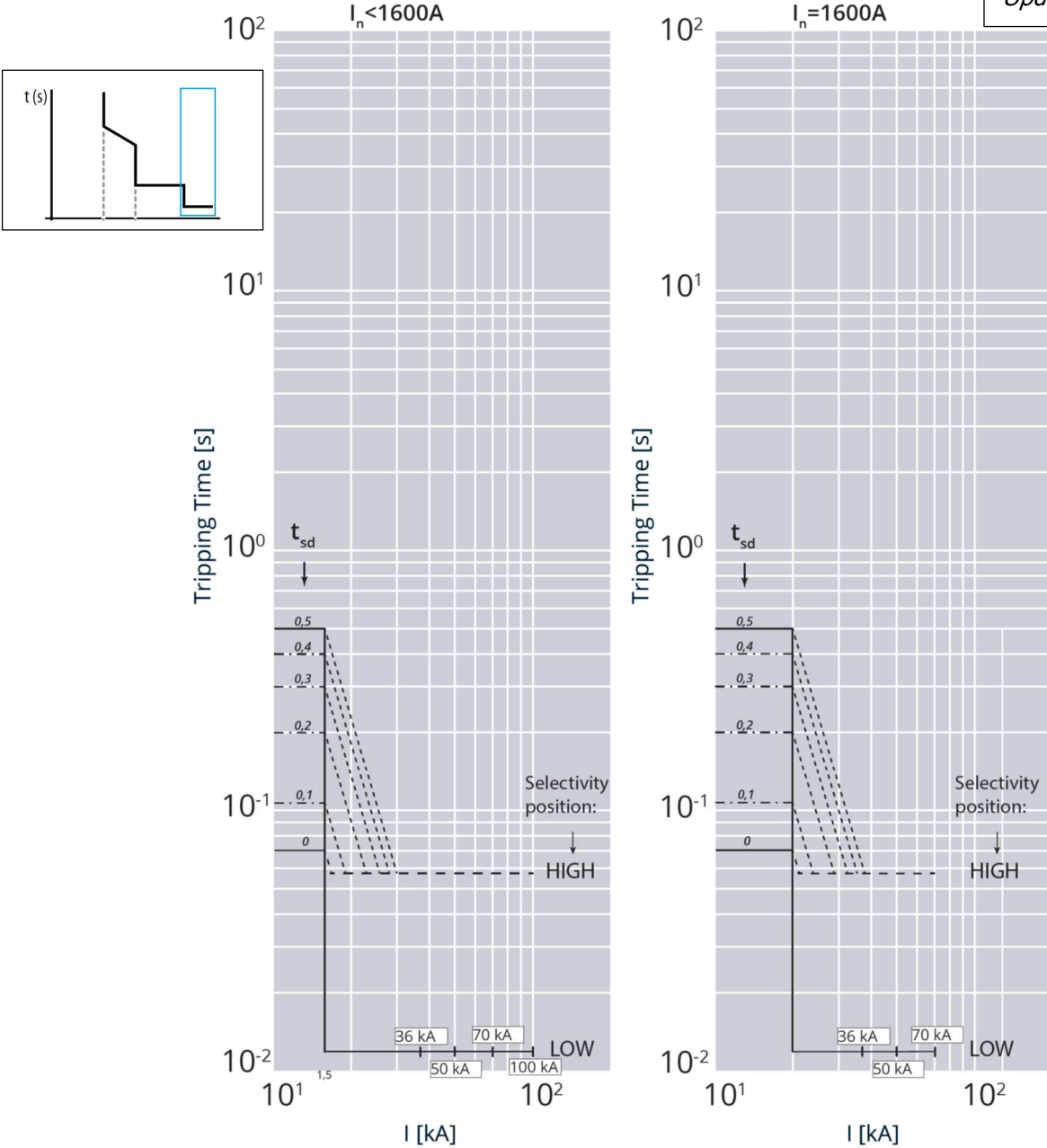

$I_{cu} = 36-50-70-100 \text{ kA}$ $I_{max} = 1600A$ 3-4 P $U_o = 415Vac$ (IEC/EN 60947-2)
Fixed Instantaneous override $I_{sf} = 15kA$ (for $I_n < 1600A$) and $I_{sf} = 20kA$ (for $I_n = 1600A$)

Value	Description
t	time
I	current
I_r	long time setting current
t_r	long time delay
I_{sd}	short time setting current
t_{sd}	short time delay
I_i	instantaneous release
I_{cu}	rated ultimate short-circuit breaking capacity
$I^2t = K$	constant pass-through energy setting
$t = K$	constant tripping time setting
—————	long time trip curve
-----	short time trip curve
Current tolerance	10% up to I_{sd} ; 20% up to I_i

10.4 Pass-through specific energy characteristic curve

Update: 03/07/2018

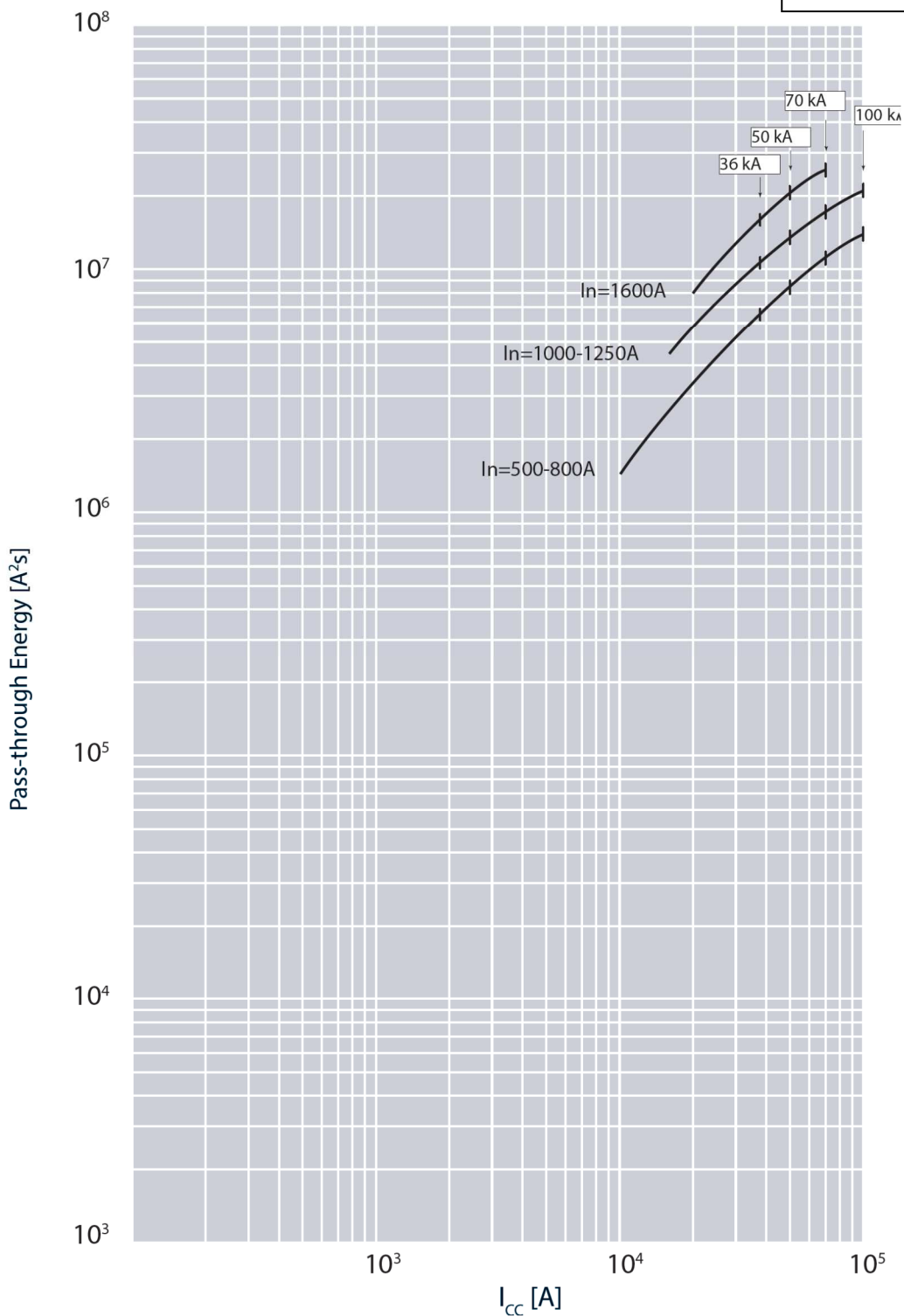

$I_{cu} = 36-50-70-100 \text{ kA}$ $I_{max} = 1600A$ 3-4 P $U_e = 415Vac$ (IEC/EN 60947-2)

Value	Description
I_{cc}	short circuit current
I^2t (A²s)	pass-through specific energy

10.5 Cut-off peak current characteristic curve (kA)

Update: 02/07/2018

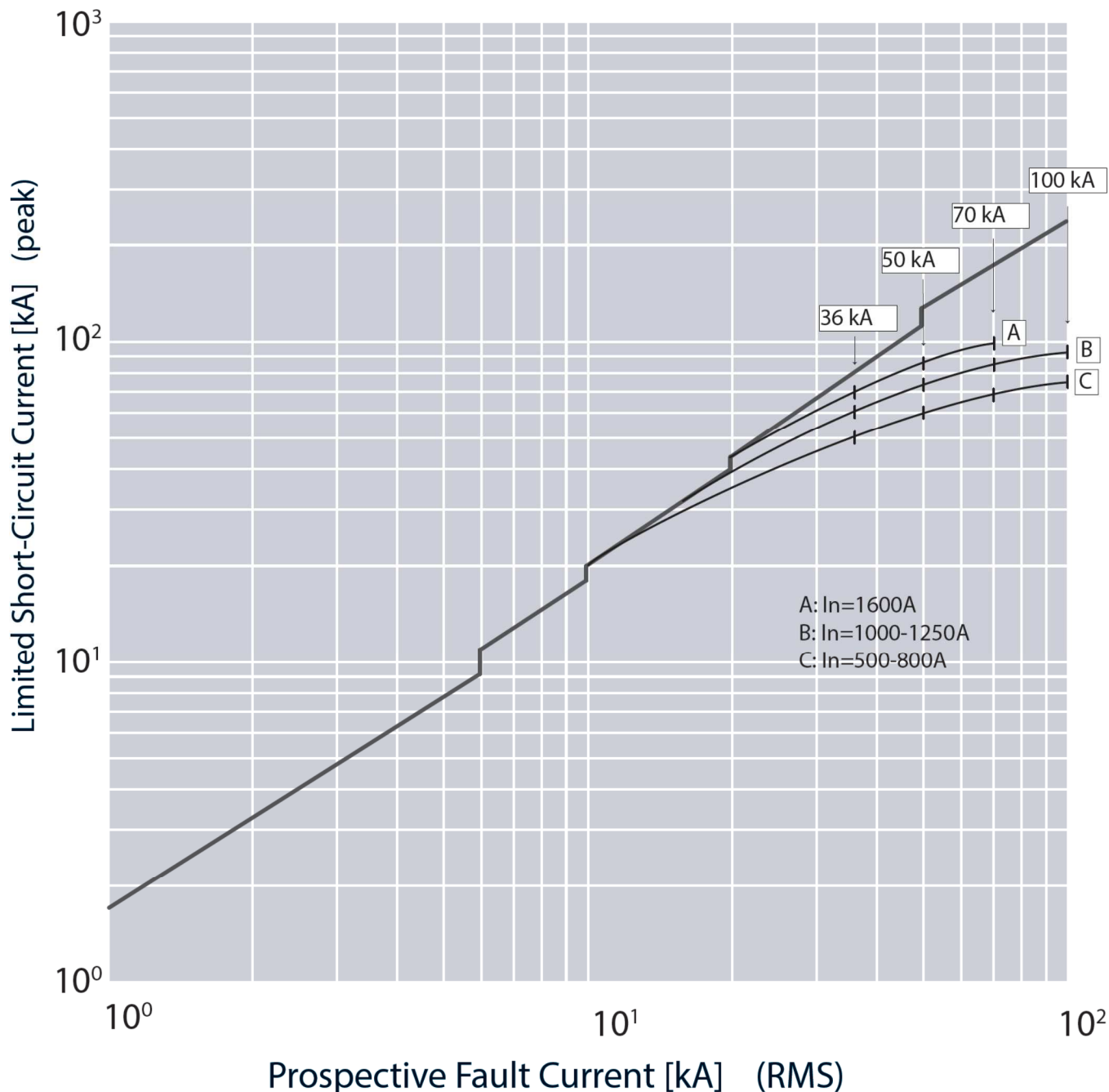

$I_{cu} = 36-50-70-100 \text{ kA}$ $I_{max} = 1600\text{A}$ 3-4 P $U_o = 415\text{Vac}$ (IEC/EN 60947-2)

Value	Description
I_{cc}	estimated short circuit symmetrical current (RMS value)
I_p	maximum short circuit peak current
	maximum prospective short circuit peak current corresponding at the power factor
	maximum real peak short circuit current

A) Derating Temperature and configurations

	Ambient temperature									
	30 °C		40 °C		50 °C		60 °C		70 °C	
Fixed version	I_{max} (A)	I_r / I_n	I_{max} (A)	I_r / I_n	I_{max} (A)	I_r / I_n	I_{max} (A)	I_r / I_n	I_{max} (A)	I_r / I_n
Spreaders, flexible cable	1600	1	1600	1	1600	1	1360	0.85	1200	0.75
Spreaders, rigid cable	1600	1	1600	1	1600	1	1360	0.85	1200	0.75
Spreaders, bars 2x50x10 Cu	1600	1	1600	1	1600	1	1520	0.95	1360	0.85
Rear flat terminals, bars 4x50x5 Cu, horizontal	1600	1	1600	1	1600	1	1600	1	1440	0.9
Rear flat staggered terminals, bars 4x50x5 Cu, horizontal	1600	1	1600	1	1600	1	1600	1	1440	0.9
Draw-out version	I_{max} (A)	I_r / I_n	I_{max} (A)	I_r / I_n	I_{max} (A)	I_r / I_n	I_{max} (A)	I_r / I_n	I_{max} (A)	I_r / I_n
Spreaders, flexible cable	1600	1	1600	1	1600	1	1280	0.8	1120	0.7
Spreaders, rigid cable	1600	1	1600	1	1600	1	1280	0.8	1120	0.7
Spreaders, bars 2x50x10 Cu	1440	0.9	1440	0.9	1440	0.9	1120	0.7	960	0.6
Rear flat terminals, bars 2x100x5 Cu, vertical	1440	0.9	1440	0.9	1440	0.9	1120	0.7	960	0.6
Rear flat staggered terminals, bars 2x100x5 Cu, vertical	1440	0.9	1440	0.9	1440	0.9	1120	0.7	960	0.6
Rear flat terminals, bars 4x50x5 Cu, horizontal	1600	1	1600	1	1600	1	1440	0.9	1120	0.7
Rear flat staggered terminals, bars 4x50x5 Cu, horizontal	1600	1	1600	1	1600	1	1440	0.9	1120	0.7

For further technical information, please contact Legrand technical support.

Data indicated in this document refers exclusively to test conditions according to product standards, unless otherwise indicated in the documentation.

For the different conditions of use of the product, inside electrical equipment or in any case inserted in the installation context, refer to the regulatory requirements of the equipment, local regulations and design specifications of the system