

Circuit breaker TX³ 6000 A up to 63 A (1 module per pole)

Cat. N° (s) : 4 039 69 to 4 040 76

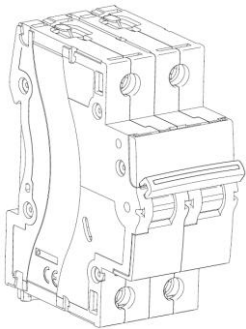

CONTENTS	PAGE
1. Description - Use	1
2. Range	1
3. Overall dimensions	1
4. Preparation - Connection	1
5. General Characteristics	2
6. Compliance and approvals	25
7. Curves	26
8. Accessories	35

1. DESCRIPTION - USE:

. Thermal-magnetic circuit breaker (MCB) with positive contact indication for control, protection against short-circuits and overloads, and isolation of electrical circuits.

Symbol:

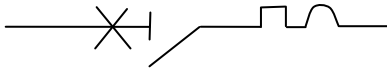

Technology:

. Limiting device

2. RANGE

Polarity:

. 1P / 2P / 3P / 4P

Width:

. 1 module per pole. Each pole is 17,7 mm

Rated currents, In:

. 6 / 10 / 16 / 20 / 25 / 32 / 40 / 50 / 63A B and C curves

Magnetic tripping curves:

- . B Curve (between 3 and 5 In)
- . C Curve (between 5 and 10 In)

Thermal threshold according to IEC/EN 60898-1:

- . Non operating current (In_f): 1.13 In.
- . Operating current (I_f): 1.45 In.

Rated Voltage and Frequency:

- . 230 V ~ / 400 V ~ - 50 / 60 Hz with standard tolerances
- . 80 V per pole DC current

Maximum operating voltage:

- . 440 V ~ with possible derating of the breaking capacity

Breaking capacity:

- . 6000 A in accordance with standard EN/IEC 60898-1

3. OVERALL DIMENSIONS:

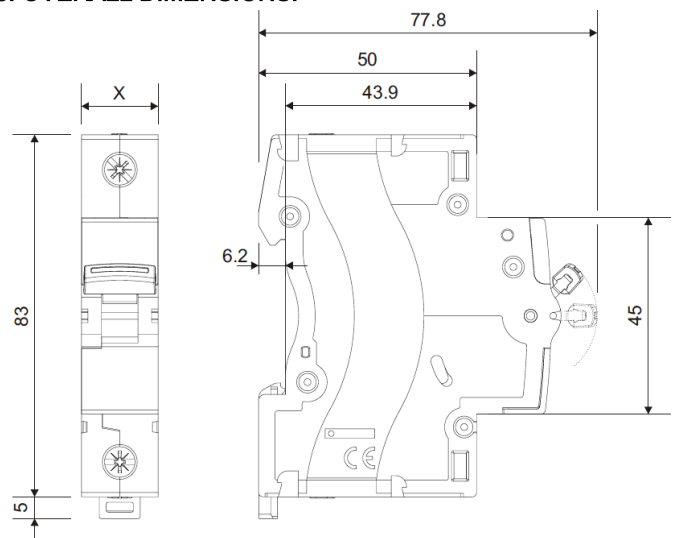

	X
1P	17.7 mm
2P	35.4 mm
3P	53.1 mm
4P	70.8 mm

4. PREPARATION - CONNECTION

Fixing:

- . On symmetrical rail EN/IEC 60715 or DIN 35 rail.

Operating positions:

- . Vertical
- . Horizontal
- . Upside down
- . On the side

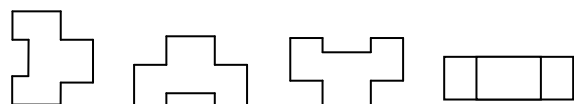

Circuit breaker TX³ 6000 A up to 63 A (1 module per pole)

Cat. N° (s) : 4 039 69 to 4 040 76

4. PREPARATION - CONNECTION *(continued)*

Power supply:

- . From the top or the bottom.

Connection:

- . Inputs and outputs via screw terminals
- . The location of the terminals allows supplying by traditional HX³ pin busbar.

Terminal depth :

- . 14 mm

Stripping length recommended:

- . 11 mm

Screw head:

- . Mixed, slotted and Pozidriv 2.

Tightening torque:

- . Recommended: 2.5 Nm.
- . Mini: 2 Nm. Maxi: 3 Nm.

Tools required:

- . For the terminals: Pozidriv n°2 or flat screwdriver 5.5 mm (6 mm maximum).
- . For fixing: flat screwdriver 5.5 mm (6 mm maximum).

Connectable section:

- . In ≤ 25A

	Copper cables	
	Without ferrule	With ferrule
Rigid cable	1 x 1.5 mm ² to 25 mm ² 2 x 1.5 mm ² to 10 mm ²	-
Flexible cable	1 x 1.5 mm ² to 16 mm ² 2 x 1.5 mm ² to 10 mm ²	1 x 1.5 mm ² to 16 mm ² 2 x 1.5 mm ² to 10 mm ²

- . In from 32A up to 63A

	Copper cables	
	Without ferrule	With ferrule
Rigid cable	1 x 1.5 mm ² to 35 mm ² 2 x 1.5 mm ² to 16 mm ²	-
Flexible cable	1 x 1.5 mm ² to 25 mm ² 2 x 1.5 mm ² to 10 mm ²	1 x 1.5 mm ² to 25 mm ² 2 x 1.5 mm ² to 10 mm ²

Manual actuation of the MCB:

- . Ergonomic 2-position handle
- . "I-ON": Device closed
- . "O-OFF": Device open

Contact status display:

- . By front face marking:
 - "O-OFF" = contacts open
 - "I-ON" = contacts closed

Sealing:

- . Possible in "Open" position (OFF) or "Close" position (ON).

Locking:

- . By 5 mm padlock (cat. N° 4 063 13) or 6 mm padlock (cat. N° 0 227 97) with padlock support (cat. N° 4 063 03).

4. PREPARATION - CONNECTION *(continued)*

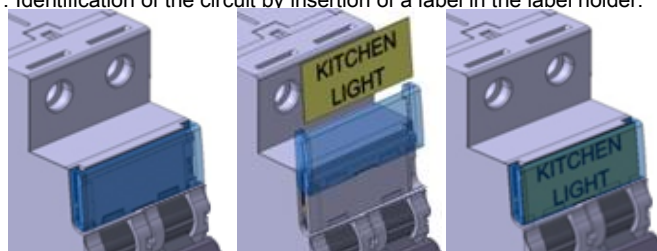

Labelling:

- . Identification of the circuit by insertion of a label in the label holder.



5. GENERAL CHARACTERISTICS:

Marking on the front side:

- . By permanent ink pad printing:
 - Trade name: TX³
 - Breaking curve
 - Rated current (in A)
 - Contact status.
 - Icn in A rated breaking capacity in accordance with IEC/EN 60898-1 (in a box)
 - Limiting class "3" (in a square)
 - Home logo , Legrand reference code, and Logo 
 - Mark: Legrand.

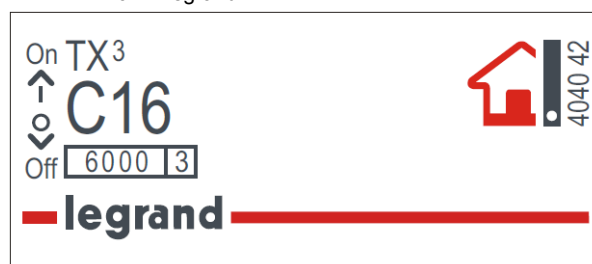

Short-circuit breaking capacity:

- . Alternate current 50/60Hz, single-phase or three-phase network, in accordance with standard: EN/IEC 60898-1

Un		1P	2P	3P / 4P
110 V~	Icn	10000 A	16000 A	-
230V~		6000 A	10000 A	10000 A
400V~		-	6000 A	6000 A
440 V~		-	4500 A	4500 A

Un	Ics	75% of Icn	75% of Icn	75% of Icn
110 V~	Ics	75% of Icn	75% of Icn	75% of Icn
230V~				
400V~				
440 V ~				

Circuit breaker TX³ 6000 A up to 63 A (1 module per pole)

Cat. N° (s) : 4 039 69 to 4 040 76

5. GENERAL CHARACTERISTICS (continued)

. Alternate current 50/60Hz, single-phase or three-phase network, in accordance with standard: EN/IEC 60947-2

Un		1P	2P	3P / 4P
110 V~	Icu	10 kA	16 kA	-
230V~		6 kA	10 kA	10 kA
400V~		-	6 kA	6 kA
440 V~		-	4.5 kA	4.5 kA

Un	Ics	75% of Icu	75% of Icu	75% of Icu
110 V~	Ics	75% of Icu	75% of Icu	75% of Icu
230V~				
400V~				
440 V~				

Short-circuit breaking capacity of only one pole:

- . Three-phase network 220 / 380 V~ to 240 / 415 V~
 - in TN neutral system, I_{cn1} = 6 kA (under 220 to 240 V~)
 - in IT neutral system, I_{it} = 3 kA (under 380 to 415 V~)
- . Three-phase network 110 / 220 V~ to 120 / 240 V~
 - in TN neutral system, I_{cn1} = 10 kA (under 110 to 127 V~)
 - in IT neutral system, I_{it} = 6 kA (under 220 to 240 V~)

Minimum operating voltage:

- . 12 V a.c. / d.c. per pole.

Pulse rated voltage:

- . U_{imp} = 4 kV

Insulation rated voltage:

- . U_i = 500 V

Pollution degree :

- . 2 in accordance with standard EN/IEC 60898-1.

Electric strength:

- . 2500 V

Operation at 400 Hz:

- . The magnetic thresholds increase by 45%.

Load to close and to open a pole through the handle:

- . 0.1 Nm per pole to close.
- . 0.075 Nm per pole to open.

Mechanical endurance:

- . 20000 operations without load.
- . 10000 operations with load (under I_n*cos φ = 0.9).
- . 2000 operations under I_n, DC current.

5. GENERAL CHARACTERISTICS (continued)

Enclosure material:

- . Polyester.
- . Characteristics of this material: self extinguishing, heat and fire resistant according to EN 60898-1, glow-wire test at 960°C for external parts made of insulating material necessary to retain in position current-carrying parts and parts of protective circuit (650°C for all other external parts made of insulating material).

Average weight per pole:

- . 0.150 kg.

Volume when packed:

	Volume (dm ³)
Single pole (packed per 10)	1.628
Double pole (packed per 5)	1.628
Triple pole / Four pole	0.720

Ambient temperatures:

- . Operation: from - 25 °C to + 70 °C
- . Storage: from - 40 °C to + 70 °C

Degree or class of protection:

- . Protection index of terminals against solid and liquid bodies: IP 20 (wired terminals), (in accordance with standards IEC 529, EN 60529 and NF C 20-010).
- . Protection index of the box against solid and liquid bodies: IP 40 (in accordance with standards IEC 529, EN 60529 and NF C 20-010).
- . Protection index against mechanical shocks: IK 02 (in accordance with standards EN 50102 and NF C 20-015).

Sinusoidal vibration resistance in accordance with IEC 60068.2.6:

- . Axis: x, y, z.
- . Frequency range: 5÷100 Hz ; duration 90 minutes
- . Displacement (5÷13,2 Hz) : 1mm
- . Acceleration (13,2÷100 Hz) : 0,7 (g=9,81 m/s²)

Recognition:

- . Recognition of the circuits by label in the "label holder" on the front-side of the MCB

Power dissipated per pole (W) :

- . Circuit breaker B and C curves

I _n	6 A	10 A	16 A	20 A
1P÷4P	1.1	1.8	2.2	2.4

I _n	25 A	32 A	40 A	50A	63A
1P÷4P	3.0	3.2	4	4.5	5.5

- . Impedance per pole (Ω) = $\frac{P \text{ dissipated}}{I_n^2}$

Circuit breaker TX³ 6000 A up to 63 A (1 module per pole)

Cat. N° (s) : 4 039 69 to 4 040 76

5. GENERAL CHARACTERISTICS *(continued)*:

Derating of circuit-breakers according to ambient temperature :

. The nominal characteristics of a circuit breaker are modified according to the ambient temperature inside the cabinet or the enclosure where the circuit breaker is located.

. Reference temperature: 30 °C in accordance with EN/IEC 60898-1

In (A)	Ambient Temperature / In									
	- 25°C	- 10°C	0°C	10°C	20°C	30°C	40°C	50°C	60°C	70°C
6	7.5	7.0	6.6	6.4	6.2	6.0	5.8	5.6	5.4	5.3
10	12.5	11.5	11.1	10.7	10.3	10.0	9.7	9.3	9.0	8.7
16	20.0	18.7	18.0	17.3	16.6	16.0	15.4	14.7	14.1	13.5
20	25.0	23.2	22.4	21.6	20.8	20.0	19.2	18.4	17.6	16.8
25	31.5	29.5	28.3	27.2	26.0	25.0	24.0	22.7	21.7	20.7
30	38.3	36.0	34.5	33.0	31.5	30.0	28.8	27.3	26.1	24.9
32	41.0	37.8	36.5	34.9	33.3	32.0	30.7	29.1	27.8	26.5
40	51.0	48.0	46.0	44.0	42.0	40.0	38.0	36.0	34.0	32.0
50	64.0	60.0	57.5	55.0	52.5	50.0	47.5	45.0	42.5	40.0
63	80.6	75.6	72.5	69.9	66.1	63.0	59.8	56.1	52.9	49.7

Derating of MCB for use with fluorescent lights:

Ferromagnetic and electronic ballasts have a high inrush current for a short time. These currents can cause the tripping of circuit breakers.

At the time of the installation, it should take into account the maximum number of ballasts per circuit breaker that the manufacturers of lamps and ballasts indicate in their catalogues.

Influence of the altitude:

	≤2000 m	3000 m	4000 m	5000 m
Dielectric holding	3000 V	2500 V	2000 V	1500 V
Max operational Voltage	400 V	400 V	400 V	400 V
Derating at 30°C	none	none	none	none

Derating of MCBs function of the number of devices side by side:

When several MCBs are juxtaposed and operate simultaneously, the thermal evacuation of the poles is limited. This results in an increase in operating temperature of the circuit breakers which can cause unwanted tripping. It is recommended to apply the following coefficients to the rated currents.

Number of circuit breakers side by side	Coefficient
2 - 3	0.9
4 - 5	0.8
6 - 9	0.7
≥ 10	0.6

These values are given by the recommendation of IEC 61439-1, NF C 63421 and EN 61439-1 standards.

To avoid using these coefficients, it is necessary to allow a good ventilation and to separate the devices with 0.5 module spacing elements (cat. N° 4 063 07).

Circuit breaker TX³ 6000 A

up to 63 A (1 module per pole)

Cat. N° (s) : 4 039 69 to 4 040 76

5. GENERAL CHARACTERISTICS *(continued)*:

Coordination between circuit-breakers and fuses, three-phase network (+ neutral) 400 / 415 V~ according to IEC/EN 60947-2:

For TT or TN neutral system in 230/400 V network, to know the breaking capacity of the combination of a double pole breaker (connected between phase and neutral under 230 V) downstream of a triple-pole circuit-breaker, take the values shown in Tables 230/400 V.

m.c.b. downstream		Fuse upstream										
		gG Type										
		≤20A	25A	32A	40A	50A	63A	80A	100A	125A	160A	
TX ³ 6000A B and C Curves	6A	100kA	100kA	100kA	100kA	100kA	100kA	100kA	100kA	100kA	100kA	40kA
	10A	100kA	100kA	100kA	100kA	100kA	100kA	100kA	100kA	100kA	100kA	40kA
	16A	-	100kA	100kA	100kA	100kA	100kA	100kA	100kA	100kA	100kA	40kA
	20A	-	-	100kA	100kA	100kA	100kA	100kA	100kA	100kA	100kA	40kA
	25A	-	-	-	100kA	100kA	100kA	100kA	100kA	100kA	100kA	40kA
	32A	-	-	-	-	100kA	100kA	100kA	100kA	100kA	100kA	40kA
	40A	-	-	-	-	-	100kA	100kA	100kA	100kA	100kA	40kA
	50A	-	-	-	-	-	-	100kA	100kA	100kA	100kA	40kA
	63A	-	-	-	-	-	-	-	100kA	100kA	100kA	40kA

m.c.b. downstream		Fuse upstream										
		aM Type										
		≤20A	25A	32A	40A	50A	63A	80A	100A	125A	160A	
TX ³ 6000A B and C Curves	6A	100kA	100kA	100kA	100kA	100kA	100kA	100kA	100kA	100kA	100kA	40kA
	10A	100kA	100kA	100kA	100kA	100kA	100kA	100kA	100kA	100kA	100kA	40kA
	16A	-	100kA	100kA	100kA	100kA	100kA	100kA	100kA	100kA	100kA	40kA
	20A	-	-	100kA	100kA	100kA	100kA	100kA	100kA	100kA	100kA	40kA
	25A	-	-	-	100kA	100kA	100kA	100kA	100kA	100kA	100kA	40kA
	32A	-	-	-	-	100kA	100kA	100kA	100kA	100kA	100kA	40kA
	40A	-	-	-	-	-	100kA	100kA	100kA	100kA	100kA	40kA
	50A	-	-	-	-	-	-	100kA	100kA	100kA	100kA	40kA
	63A	-	-	-	-	-	-	-	100kA	100kA	100kA	40kA

According to the curves and ratings of circuit breakers, attention to the threshold and size of upstream fuse which must necessarily be higher.

Circuit breaker TX³ 6000 A up to 63 A (1 module per pole)

Cat. N° (s) : 4 039 69 to 4 040 76

5. GENERAL CHARACTERISTICS *(continued)*:

Coordination between modular circuit-breakers, three-phase network (+ neutral) 400 / 415 V~ according to IEC/EN 60947-2:

For TT or TN neutral system in 230/400 V network, to know the breaking capacity of the combination of a double pole breaker (connected between phase and neutral under 230 V) downstream of a triple-pole circuit-breaker, take the values shown in Tables 230/400 V.

m.c.b. downstream		m.c.b. upstream									
		TX ³ 10kA - DX ³ 6000A/10kA									
		B and C Curves					D Curve				
		≤25A	32A	40A	50A	63A	≤25A	32A	40A	50A	63A
TX ³ 6000A B and C Curves	6A	10kA	10kA	10kA	10kA	10kA	10kA	10kA	10kA	10kA	10kA
	10A	10kA	10kA	10kA	10kA	10kA	10kA	10kA	10kA	10kA	10kA
	16A	10kA	10kA	10kA	10kA	10kA	10kA	10kA	10kA	10kA	10kA
	20A	10kA	10kA	10kA	10kA	10kA	10kA	10kA	10kA	10kA	10kA
	25A	-	10kA	10kA	10kA	10kA	-	10kA	10kA	10kA	10kA
	32A	-	-	10kA	10kA	10kA	-	-	10kA	10kA	10kA
	40A	-	-	-	10kA	10kA	-	-	-	10kA	10kA
	50A	-	-	-	-	10kA	-	-	-	-	10kA
63A	-	-	-	-	-	-	-	-	-	-	

m.c.b. downstream		m.c.b. upstream							
		DX ³ 10000/16kA							
		B and C Curves							
		≤25A	32A	40A	50A	63A	80A	100A	125A
TX ³ 6000A B and C Curves	6A	16kA	16kA	16kA	16kA	16kA	16kA	16kA	16kA
	10A	16kA	16kA	16kA	16kA	16kA	16kA	16kA	16kA
	16A	16kA	16kA	16kA	16kA	16kA	16kA	16kA	16kA
	20A	16kA	16kA	16kA	16kA	16kA	16kA	16kA	16kA
	25A	-	16kA	16kA	16kA	16kA	16kA	16kA	16kA
	32A	-	-	16kA	16kA	16kA	16kA	16kA	16kA
	40A	-	-	-	16kA	16kA	16kA	16kA	16kA
	50A	-	-	-	-	16kA	16kA	16kA	16kA
	63A	-	-	-	-	-	16kA	16kA	16kA

According to the curves and ratings of circuit breakers, attention to the magnetic threshold and to the size of upstream circuit breakers which must necessarily be higher.

Circuit breaker TX³ 6000 A up to 63 A (1 module per pole)

Cat. N° (s) : 4 039 69 to 4 040 76

5. GENERAL CHARACTERISTICS *(continued)*:

Coordination between modular circuit-breakers, three-phase network (+ neutral) 400 / 415 V~ according to IEC/EN 60947-2:

For TT or TN neutral system in 230/400 V network, to know the breaking capacity of the combination of a double pole breaker (connected between phase and neutral under 230 V) downstream of a triple-pole circuit-breaker, take the values shown in Tables 230/400 V.

		m.c.b. upstream							
		DX ³ 25kA							
		B, C and D Curves							
m.c.b. downstream		≤25A	32A	40A	50A	63A	80A	100A	125A
TX ³ 6000A B and C Curves	6A	16kA	16kA	16kA	16kA	16kA	16kA	16kA	16kA
	10A	16kA	16kA	16kA	16kA	16kA	16kA	16kA	16kA
	16A	16kA	16kA	16kA	16kA	16kA	16kA	16kA	16kA
	20A	16kA	16kA	16kA	16kA	16kA	16kA	16kA	16kA
	25A	-	16kA	16kA	16kA	16kA	16kA	16kA	16kA
	32A	-	-	16kA	16kA	16kA	16kA	16kA	16kA
	40A	-	-	-	16kA	16kA	16kA	16kA	16kA
	50A	-	-	-	-	16kA	16kA	16kA	16kA
	63A	-	-	-	-	-	16kA	16kA	16kA

		m.c.b. upstream					
		DX ³ 36kA					
		C Curve					
m.c.b. downstream		≤25A	32A	40A	50A	63A	80A
TX ³ 6000A B and C Curves	6A	25kA	25kA	25kA	25kA	25kA	25kA
	10A	25kA	25kA	25kA	25kA	25kA	25kA
	16A	25kA	25kA	25kA	25kA	25kA	25kA
	20A	25kA	25kA	25kA	25kA	25kA	25kA
	25A	-	25kA	25kA	25kA	25kA	25kA
	32A	-	-	25kA	25kA	25kA	25kA
	40A	-	-	-	25kA	25kA	25kA
	50A	-	-	-	-	25kA	25kA
	63A	-	-	-	-	-	25kA

According to the curves and ratings of circuit breakers, attention to the magnetic threshold and to the size of upstream circuit breakers which must necessarily be higher.

Circuit breaker TX³ 6000 A up to 63 A (1 module per pole)

Cat. N° (s) : 4 039 69 to 4 040 76

5. GENERAL CHARACTERISTICS *(continued)*:

Coordination between modular circuit-breakers and MCCBs, three-phase network (+ neutral) 400 / 415 V~ according to IEC/EN60947-2:

For TT or TN neutral system in 230/400 V network, to know the breaking capacity of the combination of a double pole breaker (connected between phase and neutral under 230 V) downstream of a triple-pole circuit-breaker, take the values shown in Tables 230/400 V.

m.c.b. downstream		m.c.b. upstream							
		DPX ³ 160 / DPX ³ 160 + diff.							
		16kA							
		16A	25A	40A	63A	80A	100A	125A	160A
TX ³ 6000A B and C Curves	6A	16kA	16kA	16kA	16kA	16kA	16kA	16kA	16kA
	10A	16kA	16kA	16kA	16kA	16kA	16kA	16kA	16kA
	16A	-	16kA	16kA	16kA	16kA	16kA	16kA	16kA
	20A	-	16kA	16kA	16kA	16kA	16kA	16kA	16kA
	25A	-	-	16kA	16kA	16kA	16kA	16kA	16kA
	32A	-	-	16kA	16kA	16kA	16kA	16kA	16kA
	40A	-	-	-	16kA	16kA	16kA	16kA	16kA
	50A	-	-	-	16kA	16kA	16kA	16kA	16kA
	63A	-	-	-	-	16kA	16kA	16kA	16kA

m.c.b. downstream		m.c.b. upstream							
		DPX ³ 160 / DPX ³ 160 + diff.							
		25 – 36 – 50kA							
		16A	25A	40A	63A	80A	100A	125A	160A
TX ³ 6000A B and C Curves	6A	25kA	25kA	25kA	25kA	25kA	25kA	25kA	25kA
	10A	25kA	25kA	25kA	25kA	25kA	25kA	25kA	25kA
	16A	-	25kA	25kA	25kA	25kA	25kA	25kA	25kA
	20A	-	25kA	25kA	25kA	25kA	25kA	25kA	25kA
	25A	-	-	25kA	25kA	25kA	25kA	25kA	25kA
	32A	-	-	25kA	25kA	25kA	25kA	25kA	25kA
	40A	-	-	-	25kA	25kA	25kA	25kA	25kA
	50A	-	-	-	25kA	25kA	25kA	25kA	25kA
	63A	-	-	-	-	25kA	25kA	25kA	25kA

According to the curves and ratings of circuit breakers, attention to the magnetic threshold and to the size of upstream circuit breakers which must necessarily be higher.

Circuit breaker TX³ 6000 A up to 63 A (1 module per pole)

Cat. N° (s) : 4 039 69 to 4 040 76

5. GENERAL CHARACTERISTICS (continued):

Coordination between modular circuit-breakers and MCCBs, three-phase network (+ neutral) 400 / 415 V~ according to IEC/EN60947-2:

For TT or TN neutral system in 230/400 V network, to know the breaking capacity of the combination of a double pole breaker (connected between phase and neutral under 230 V) downstream of a triple-pole circuit-breaker, take the values shown in Tables 230/400 V.

m.c.b. downstream		m.c.c.b. upstream						
		DPX 250ER			DPX ³ 250 / DPX ³ 250+diff. (Thermal-magnetic & electronic)			
		25 - 36 - 50kA			25 - 36 - 50 - 70kA			
		100A	160A	250A	100A	160A	200A	250A
TX ³ 6000A B and C Curves	6A	25kA	25kA	25kA	25kA	25kA	25kA	25kA
	10A	25kA	25kA	25kA	25kA	25kA	25kA	25kA
	16A	25kA	25kA	25kA	25kA	25k	25kA	25kA
	20A	25kA	25kA	25kA	25kA	25kA	25kA	25kA
	25A	25kA	25kA	25kA	25kA	25kA	25kA	25kA
	32A	25kA	25kA	25kA	25kA	25kA	25kA	25kA
	40A	25kA	25kA	25kA	25kA	25kA	25kA	25kA
	50A	25kA	25kA	25kA	25kA	25kA	25kA	25kA
63A	20kA	20kA	20kA	25kA	25kA	25kA	25kA	

m.c.b. downstream		m.c.c.b. upstream										
		DPX / H / L 250 (Thermal-magnetic & electronic)						DPX / H / L 630 (Thermal-magnetic & electronic)				
		36 - 70 - 100kA						36 - 70 - 100kA				
		25A	40A	63A	100A	160A	250A	250A	320A	400A	500A	630A
TX ³ 6000A B and C Curves	6A	25kA	25kA	25kA	25kA	25kA	25kA	25kA	25kA	25kA	25kA	25kA
	10A	25kA	25kA	25kA	25kA	25kA	25kA	25kA	25kA	25kA	25kA	25kA
	16A	25kA	25kA	25kA	25kA	25kA	25kA	25kA	25kA	25kA	25kA	25kA
	20A	25kA	25kA	25kA	25kA	25kA	25kA	25kA	25kA	25kA	25kA	25kA
	25A	-	25kA	25kA	25kA	25kA	25kA	25kA	25kA	25kA	25kA	25kA
	32A	-	25kA	25kA	25kA	25kA	25kA	25kA	25kA	25kA	25kA	25kA
	40A	-	-	25kA	25kA	25kA	25kA	20kA	20kA	20kA	20kA	20kA
	50A	-	-	25kA	25kA	25kA	25kA	16kA	16kA	16kA	16kA	16kA
63A	-	-	20kA	20kA	20kA	20kA	16kA	16kA	16kA	16kA	16kA	

According to the curves and ratings of circuit breakers, attention to the magnetic (or electronic) threshold and to the size of upstream circuit breakers which must necessarily be higher.

Circuit breaker TX³ 6000 A

up to 63 A (1 module per pole)

Cat. N° (s) : 4 039 69 to 4 040 76

5. GENERAL CHARACTERISTICS *(continued)*:

Coordination between modular circuit-breakers and MCCBs, three-phase network (+ neutral) 400 / 415 V~ according to IEC/EN60947-2:

For TT or TN neutral system in 230/400 V network, to know the breaking capacity of the combination of a double pole breaker (connected between phase and neutral under 230 V) downstream of a triple-pole circuit-breaker, take the values shown in Tables 230/400 V.

		m.c.c.b.. upstream	
		DPX / H / L 1250 (Thermal -magnetic)	DPX / H 1600 (electronic)
		50 – 70 – 100kA	36 – 70kA
m.c.b. downstream		500 to 1250A	630 to 1600A
TX ³ 6000A B and C Curves	6A	25kA	25kA
	10A	25kA	25kA
	16A	25kA	25kA
	20A	25kA	25kA
	25A	20kA	20kA
	32A	15kA	15kA
	40A	15kA	15kA
	50A	12.5kA	12.5kA
	63A	12.5kA	12.5kA

According to the curves and ratings of circuit breakers, attention to the magnetic (or electronic) threshold and to the size of upstream circuit breakers which must necessarily be higher.

Circuit breaker TX³ 6000 A up to 63 A (1 module per pole)

Cat. N° (s) : 4 039 69 to 4 040 76

5. GENERAL CHARACTERISTICS *(continued)*:

Coordination between modular circuit-breakers and fuses, three-phase network (+ neutral) 230 / 240 V~ according to IEC/EN 60947-2:

		Fuse upstream									
		gG Type									
m.c.b. downstream		≤20A	25A	32A	40A	50A	63A	80A	100A	125A	160A
TX ³ 6000A B and C Curves	6A	100kA	100kA	100kA	100kA	100kA	100kA	100kA	100kA	100kA	40kA
	10A	100kA	100kA	100kA	100kA	100kA	100kA	100kA	100kA	100kA	40kA
	16A	-	100kA	100kA	100kA	100kA	100kA	100kA	100kA	100kA	40kA
	20A	-	-	100kA	100kA	100kA	100kA	100kA	100kA	100kA	40kA
	25A	-	-	-	100kA	100kA	100kA	100kA	100kA	100kA	40kA
	32A	-	-	-	-	100kA	100kA	100kA	100kA	100kA	40kA
	40A	-	-	-	-	-	100kA	100kA	100kA	100kA	40kA
	50A	-	-	-	-	-	-	100kA	100kA	100kA	40kA
	63A	-	-	-	-	-	-	100kA	100kA	100kA	40kA

		Fuse upstream									
		aM Type									
m.c.b. downstream		≤20A	25A	32A	40A	50A	63A	80A	100A	125A	160A
TX ³ 6000A B and C Curves	6A	100kA	100kA	100kA	100kA	100kA	100kA	100kA	100kA	100kA	40kA
	10A	100kA	100kA	100kA	100kA	100kA	100kA	100kA	100kA	100kA	40kA
	16A	-	100kA	100kA	100kA	100kA	100kA	100kA	100kA	100kA	40kA
	20A	-	-	100kA	100kA	100kA	100kA	100kA	100kA	100kA	40kA
	25A	-	-	-	100kA	100kA	100kA	100kA	100kA	100kA	40kA
	32A	-	-	-	-	100kA	100kA	100kA	100kA	100kA	40kA
	40A	-	-	-	-	-	100kA	100kA	100kA	100kA	40kA
	50A	-	-	-	-	-	-	100kA	100kA	100kA	40kA
	63A	-	-	-	-	-	-	100kA	100kA	100kA	40kA

According to the curves and ratings of circuit breakers, attention to the threshold and to the size of upstream fuses which must necessarily be higher.

Circuit breaker TX³ 6000 A up to 63 A (1 module per pole)

Cat. N° (s) : 4 039 69 to 4 040 76

5. GENERAL CHARACTERISTICS *(continued)*:

Coordination between modular circuit-breakers, three-phase network (+ neutral) 230 / 240 V~ according to IEC/EN 60947-2:

m.c.b. downstream		m.c.b. upstream									
		TX ³ 10kA - DX ³ 6000A/10kA									
		B and C Curves					D Curve				
		≤25A	32A	40A	50A	63A	≤25A	32A	40A	50A	63A
TX ³ 6000A B and C Curves	6A	16kA	16kA	16kA	16kA	16kA	16kA	16kA	16kA	16kA	16kA
	10A	16kA	16kA	16kA	16kA	16kA	16kA	16kA	16kA	16kA	16kA
	16A	16kA	16kA	16kA	16kA	16kA	16kA	16kA	16kA	16kA	16kA
	20A	16kA	16kA	16kA	16kA	16kA	16kA	16kA	16kA	16kA	16kA
	25A	-	16kA	16kA	16kA	16kA	-	16kA	16kA	16kA	16kA
	32A	-	-	16kA	16kA	16kA	-	-	16kA	16kA	16kA
	40A	-	-	-	16kA	16kA	-	-	-	16kA	16kA
	50A	-	-	-	-	16kA	-	-	-	-	16kA
63A	-	-	-	-	-	-	-	-	-	-	

m.c.b. downstream		m.c.b. upstream							
		DX ³ 10000/16kA							
		B and C Curves							
		≤25A	32A	40A	50A	63A	80A	100A	125A
TX ³ 6000A B and C Curves	6A	25kA	25kA	25kA	25kA	25kA	25kA	25kA	25kA
	10A	25kA	25kA	25kA	25kA	25kA	25kA	25kA	25kA
	16A	25kA	25kA	25kA	25kA	25kA	25kA	25kA	25kA
	20A	25kA	25kA	25kA	25kA	25kA	25kA	25kA	25kA
	25A	-	25kA	25kA	25kA	25kA	25kA	25kA	25kA
	32A	-	-	25kA	25kA	25kA	25kA	25kA	25kA
	40A	-	-	-	25kA	25kA	25kA	25kA	25kA
	50A	-	-	-	-	25kA	25kA	25kA	25kA
63A	-	-	-	-	-	25kA	25kA	25kA	

According to the curves and ratings of circuit breakers, attention to the magnetic threshold and to the size of upstream circuit breakers which must necessarily be higher.

Circuit breaker TX³ 6000 A up to 63 A (1 module per pole)

Cat. N° (s) : 4 039 69 to 4 040 76

5. GENERAL CHARACTERISTICS *(continued)*:

Coordination between modular circuit-breakers, three-phase network (+ neutral) 230 / 240 V~ according to IEC/EN 60947-2:

		m.c.b. upstream							
		DX ³ 25kA							
		B, C and D Curves							
m.c.b. downstream		≤25A	32A	40A	50A	63A	80A	100A	125A
TX ³ 6000A B and C Curves	6A	25kA	25kA	25kA	25kA	25kA	25kA	25kA	25kA
	10A	25kA	25kA	25kA	25kA	25kA	25kA	25kA	25kA
	16A	25kA	25kA	25kA	25kA	25kA	25kA	25kA	25kA
	20A	25kA	25kA	25kA	25kA	25kA	25kA	25kA	25kA
	25A	-	25kA	25kA	25kA	25kA	25kA	25kA	25kA
	32A	-	-	25kA	25kA	25kA	25kA	25kA	25kA
	40A	-	-	-	25kA	25kA	25kA	25kA	25kA
	50A	-	-	-	-	25kA	25kA	25kA	25kA
63A	-	-	-	-	-	25kA	25kA	25kA	

		m.c.b. upstream					
		DX ³ 36kA					
		C Curve					
m.c.b. downstream		≤25A	32A	40A	50A	63A	80A
TX ³ 6000A B and C Curves	6A	36kA	36kA	36kA	36kA	36kA	36kA
	10A	36kA	36kA	36kA	36kA	36kA	36kA
	16A	36kA	36kA	36kA	36kA	36kA	36kA
	20A	36kA	36kA	36kA	36kA	36kA	36kA
	25A	-	36kA	36kA	36kA	36kA	36kA
	32A	-	-	36kA	36kA	36kA	36kA
	40A	-	-	-	36kA	36kA	36kA
	50A	-	-	-	-	36kA	36kA
63A	-	-	-	-	-	36kA	

According to the curves and ratings of circuit breakers, attention to the magnetic threshold and to the size of upstream circuit breakers which must necessarily be higher.

Circuit breaker TX³ 6000 A up to 63 A (1 module per pole)

Cat. N° (s) : 4 039 69 to 4 040 76

5. GENERAL CHARACTERISTICS *(continued)*:

Coordination between modular circuit-breakers and M.C.C.Bs (Moulded Case Circuit Breakers), three-phase network (+ neutral)
230 / 240 V~ according to IEC/EN 60947-2:

		m.c.c.b. upstream							
		DPX ³ 160 / DPX ³ 160 + diff.							
		16kA							
m.c.b. downstream		16A	25A	40A	63A	80A	100A	125A	160A
TX ³ 6000A B and C Curves	6A	25kA	25kA	25kA	25kA	25kA	25kA	25kA	25kA
	10A	25kA	25kA	25kA	25kA	25kA	25kA	25kA	25kA
	16A	-	25kA	25kA	25kA	25kA	25kA	25kA	25kA
	20A	-	25kA	25kA	25kA	25kA	25kA	25kA	25kA
	25A	-	-	25kA	25kA	25kA	25kA	25kA	25kA
	32A	-	-	25kA	25kA	25kA	25kA	25kA	25kA
	40A	-	-	-	25kA	25kA	25kA	25kA	25kA
	50A	-	-	-	25kA	25kA	25kA	25kA	25kA
	63A	-	-	-	-	25kA	25kA	25kA	25kA

		m.c.c.b. upstream							
		DPX ³ 160 / DPX ³ 160 + diff.							
		25kA							
m.c.b. downstream		16A	25A	40A	63A	80A	100A	125A	160A
TX ³ 6000A B and C Curves	6A	40kA	40kA	40kA	40kA	40kA	40kA	40kA	40kA
	10A	40kA	40kA	40kA	40kA	40kA	40kA	40kA	40kA
	16A	-	40kA	40kA	40kA	40kA	40kA	40kA	40kA
	20A	-	40kA	40kA	40kA	40kA	40kA	40kA	40kA
	25A	-	-	40kA	40kA	40kA	40kA	40kA	40kA
	32A	-	-	40kA	40kA	40kA	40kA	40kA	40kA
	40A	-	-	-	40kA	40kA	40kA	40kA	40kA
	50A	-	-	-	40kA	40kA	40kA	40kA	40kA
	63A	-	-	-	-	40kA	40kA	40kA	40kA

According to the curves and ratings of circuit breakers, attention to the magnetic threshold and to the size of upstream circuit breakers which must necessarily be higher.

Circuit breaker TX³ 6000 A up to 63 A (1 module per pole)

Cat. N° (s) : 4 039 69 to 4 040 76

5. GENERAL CHARACTERISTICS *(continued)*:

Coordination between modular circuit-breakers and M.C.C.Bs (Moulded Case Circuit Breakers), three-phase network (+ neutral)
230 / 240 V~ according to IEC/EN 60947-2:

		m.c.c.b. upstream							
		DPX ³ 160 / DPX ³ 160 + diff.							
		36 - 50kA							
m.c.b. downstream		16A	25A	40A	63A	80A	100A	125A	160A
TX ³ 6000A B and C Curves	6A	50kA	50kA	50kA	50kA	50kA	50kA	50kA	50kA
	10A	50kA	50kA	50kA	50kA	50kA	50kA	50kA	50kA
	16A	-	50kA	50kA	50kA	50kA	50kA	50kA	50kA
	20A	-	50kA	50kA	50kA	50kA	50kA	50kA	50kA
	25A	-	-	50kA	50kA	50kA	50kA	50kA	50kA
	32A	-	-	50kA	50kA	50kA	50kA	50kA	50kA
	40A	-	-	-	50kA	50kA	50kA	50kA	50kA
	50A	-	-	-	50kA	50kA	50kA	50kA	50kA
	63A	-	-	-	-	50kA	50kA	50kA	50kA

		m.c.c.b. upstream					
		DPX 250ER			DPX 250ER		
		25kA			36 - 50kA		
m.c.b. downstream		100A	160A	250A	100A	160A	250A
TX ³ 6000A B and C Curves	6A	40kA	40kA	40kA	50kA	50kA	50kA
	10A	40kA	40kA	40kA	50kA	50kA	50kA
	16A	40kA	40kA	40kA	50kA	50kA	50kA
	20A	40kA	40kA	40kA	50kA	50kA	50kA
	25A	40kA	40kA	40kA	50kA	50kA	50kA
	32A	40kA	40kA	40kA	50kA	50kA	50kA
	40A	40kA	40kA	40kA	50kA	50kA	50kA
	50A	36kA	36kA	36kA	36kA	36kA	36kA
	63A	30kA	30kA	30kA	30kA	30kA	30kA

According to the curves and ratings of circuit breakers, attention to the magnetic threshold and to the size of upstream circuit breakers which must necessarily be higher.

Circuit breaker TX³ 6000 A up to 63 A (1 module per pole)

Cat. N° (s) : 4 039 69 to 4 040 76

5. GENERAL CHARACTERISTICS *(continued)*:

Coordination between modular circuit-breakers and M.C.C.Bs (Moulded Case Circuit Breakers), three-phase network (+ neutral) 230 / 240 V~ according to IEC/EN 60947-2:

		m.c.c.b. upstream							
		DPX ³ 250 / DPX ³ 250+diff. (Thermal-magnetic & electronic)				DPX ³ 250 / DPX ³ 250+diff. (Thermal-magnetic & electronic)			
		25kA				36 – 50 - 70kA			
m.c.b. downstream		100A	160A	200A	250A	100A	160A	200A	250A
TX ³ 6000A B and C Curves	6A	40kA	40kA	40kA	40kA	50kA	50kA	50kA	50kA
	10A	40kA	40kA	40kA	40kA	50kA	50kA	50kA	50kA
	16A	40kA	40kA	40kA	40kA	50kA	50kA	50kA	50kA
	20A	40kA	40kA	40kA	40kA	50kA	50kA	50kA	50kA
	25A	40kA	40kA	40kA	40kA	50kA	50kA	50kA	50kA
	32A	40kA	40kA	40kA	40kA	50kA	50kA	50kA	50kA
	40A	40kA	40kA	40kA	40kA	50kA	50kA	50kA	50kA
	50A	40kA	40kA	40kA	40kA	50kA	50kA	50kA	50kA
	63A	40kA	40kA	40kA	40kA	50kA	50kA	50kA	50kA

		m.c.c.b. upstream										
		DPX / H / L 250 (Thermal-magnetic & electronic)						DPX / H / L 630 (Thermal-magnetic & electronic)				
		36 - 70 – 100kA						36 - 70 – 100kA				
m.c.b. downstream		25A	40A	63A	100A	160A	250A	250A	320A	400A	500A	630A
TX ³ 6000A B and C Curves	6A	50kA	50kA	50kA	50kA	50kA	50kA	50kA	50kA	50kA	50kA	50kA
	10A	50kA	50kA	50kA	50kA	50kA	50kA	50kA	50kA	50kA	50kA	50kA
	16A	50kA	50kA	50kA	50kA	50kA	50kA	50kA	50kA	50kA	50kA	50kA
	20A	50kA	50kA	50kA	50kA	50kA	50kA	50kA	50kA	50kA	50kA	50kA
	25A	-	50kA	50kA	50kA	50kA	50kA	50kA	50kA	50kA	50kA	50kA
	32A	-	50kA	50kA	50kA	50kA	50kA	50kA	50kA	50kA	50kA	50kA
	40A	-	-	50kA	50kA	50kA	50kA	50kA	50kA	50kA	50kA	50kA
	50A	-	-	30kA	30kA	30kA	30kA	30kA	30kA	30kA	30kA	30kA
	63A	-	-	-	30kA	30kA	30kA	30kA	30kA	30kA	30kA	30kA

According to the curves and ratings of circuit breakers, attention to the magnetic (or electronic) threshold and to the size of upstream circuit breakers which must necessarily be higher.

Circuit breaker TX³ 6000 A up to 63 A (1 module per pole)

Cat. N° (s) : 4 039 69 to 4 040 76

5. GENERAL CHARACTERISTICS *(continued)*:

Coordination between modular circuit-breakers and M.C.C.Bs (Moulded Case Circuit Breakers), three-phase network (+ neutral) 230 / 240 V~ according to IEC/EN 60947-2:

		m.c.c.b. upstream	
		DPX / H / L 1250 (Thermal-magnetic)	DPX / H 1600 (electronic)
		50 – 70 – 100kA	36 – 70kA
m.c.b. downstream		500 to 1250A	630 to 1600A
TX ³ 6000A B and C Curves	6A	50kA	50kA
	10A	50kA	50kA
	16A	50kA	50kA
	20A	50kA	50kA
	25A	50kA	50kA
	32A	50kA	50kA
	40A	50kA	50kA
	50A	25kA	25kA
	63A	25kA	25kA

According to the curves and ratings of circuit breakers, attention to the magnetic (or electronic) threshold and to the size of upstream circuit breakers which must necessarily be higher.

Circuit breaker TX³ 6000 A up to 63 A (1 module per pole)

Cat. N° (s) : 4 039 69 to 4 040 76

5. GENERAL CHARACTERISTICS *(continued)*

Selectivity between two levels of protection

- . The downstream circuit breaker must always have a magnetic threshold and a rated current lower than those of the upstream protection.
- . Selectivity is indicated total (T) if there is selectivity up to the value of breaking capacity (according to IEC / EN 60947-2) of the downstream circuit breaker.

Selectivity between modular circuit breakers and fuses:

- . Selectivity limit at 400 V~: values in Ampere.

m.c.b. downstream		Fuse upstream							
		gG Type							
		32A	40A	50A	63A	80A	100A	125A	160A
TX ³ 6000A B and C Curves	6A	1300	1900	2500	4000	4600	T	T	T
	10A	-	1600	2200	3200	3600	T	T	T
	16A	-	1400	1800	2600	3000	5600	T	T
	20A	-	1200	1500	2200	2500	4600	T	T
	25A	-	-	1300	2000	2200	4100	5500	T
	32A	-	-	1200	1700	1900	3500	4500	T
	40A	-	-	-	-	1700	3000	4000	T
	50A	-	-	-	-	1600	2600	3500	5000
63A	-	-	-	-	-	2400	3300	5000	

m.c.b. downstream		Fuse upstream								
		aM Type								
		25A	32A	40A	50A	63A	80A	100A	125A	160A
TX ³ 6000A B and C Curves	6A	1000	1600	2100	3200	T	T	T	T	T
	10A	-	1100	1700	2500	5000	T	T	T	T
	16A	-	1000	1400	2100	4000	T	T	T	T
	20A	-	-	1300	1800	3400	5100	T	T	T
	25A	-	-	1100	1600	3000	4500	T	T	T
	32A	-	-	-	1300	2400	3800	5000	T	T
	40A	-	-	-	-	2100	3100	4200	T	T
	50A	-	-	-	-	2000	2900	3700	T	T
63A	-	-	-	-	-	2800	3500	5500	T	

- . T = Total discrimination

Circuit breaker TX³ 6000 A up to 63 A (1 module per pole)

Cat. N° (s) : 4 039 69 to 4 040 76

5. GENERAL CHARACTERISTICS *(continued)*:

Selectivity between modular circuit breakers:

. Selectivity limit at 400 V~: values in Ampere.

		m.c.b. upstream							
		TX ³ 10kA - DX ³ 6000A/10kA							
		B Curve							
m.c.b. downstream		10A	16A	20A	25A	32A	40A	50A	63A
TX ³ 6000A B and C Curves	6A	-	64	80	100	128	160	200	252
	10A	-	-	80	100	128	160	200	252
	16A	-	-	-	-	128	160	200	252
	20A	-	-	-	-	-	160	200	252
	25A	-	-	-	-	-	160	200	252
	32A	-	-	-	-	-	-	-	252
	40A	-	-	-	-	-	-	-	-
	50A	-	-	-	-	-	-	-	-
63A	-	-	-	-	-	-	-	-	

		m.c.b. upstream							
		TX ³ 10kA - DX ³ 6000A/10kA							
		C Curve							
m.c.b. downstream		10A	16A	20A	25A	32A	40A	50A	63A
TX ³ 6000A B and C Curves	6A	75	120	150	187	240	300	375	472
	10A	-	120	150	187	240	300	375	472
	16A	-	-	150	187	240	300	375	472
	20A	-	-	-	187	240	300	375	472
	25A	-	-	-	-	240	300	375	472
	32A	-	-	-	-	-	300	375	472
	40A	-	-	-	-	-	-	375	472
	50A	-	-	-	-	-	-	-	472
	63A	-	-	-	-	-	-	-	-

. T = Total discrimination

Circuit breaker TX³ 6000 A up to 63 A (1 module per pole)

Cat. N° (s) : 4 039 69 to 4 040 76

5. GENERAL CHARACTERISTICS *(continued)*:

Selectivity between modular circuit breakers:

. Selectivity limit at 400 V~: values in Ampere.

		m.c.b. upstream							
		DX ³ 6000A/10kA							
		D Curve							
m.c.b. downstream		10A	16A	20A	25A	32A	40A	50A	63A
TX ³ 6000A B and C Curves	6A	120	192	240	300	384	480	600	756
	10A	-	192	240	300	384	480	600	756
	16A	-	-	240	300	384	480	600	756
	20A	-	-	-	300	384	480	600	756
	25A	-	-	-	-	384	480	600	756
	32A	-	-	-	-	-	480	600	756
	40A	-	-	-	-	-	-	600	756
	50A	-	-	-	-	-	-	-	756
63A	-	-	-	-	-	-	-	-	

		m.c.b. upstream										
		DX ³ 10000/16kA										
		B Curve										
m.c.b. downstream		10A	16A	20A	25A	32A	40A	50A	63A	80A	100A	125A
TX ³ 6000A B and C Curves	6A	-	64	80	100	128	160	200	252	800	1000	1300
	10A	-	-	80	100	128	160	200	252	750	960	1200
	16A	-	-	-	-	128	160	200	252	630	800	960
	20A	-	-	-	-	-	160	200	252	600	730	900
	25A	-	-	-	-	-	160	200	252	560	650	850
	32A	-	-	-	-	-	-	-	252	500	630	800
	40A	-	-	-	-	-	-	-	-	460	560	700
	50A	-	-	-	-	-	-	-	-	430	500	650
	63A	-	-	-	-	-	-	-	-	-	500	650

Circuit breaker TX³ 6000 A up to 63 A (1 module per pole)

Cat. N° (s) : 4 039 69 to 4 040 76

5. GENERAL CHARACTERISTICS *(continued)*:

Selectivity between modular circuit breakers:

. Selectivity limit at 400 V~: values in Ampere.

		m.c.b. upstream										
		DX ³ 10000/16kA										
		C Curve										
m.c.b. downstream		10A	16A	20A	25A	32A	40A	50A	63A	80A	100A	125A
TX ³ 6000A B and C Curves	6A	75	120	150	187	240	300	375	472	1300	1600	2000
	10A	-	120	150	187	240	300	375	472	1150	1450	1800
	16A	-	-	150	187	240	300	375	472	950	1200	1500
	20A	-	-	-	187	240	300	375	472	900	1100	1400
	25A	-	-	-	-	240	300	375	472	850	1000	1300
	32A	-	-	-	-	-	300	375	472	750	950	1200
	40A	-	-	-	-	-	-	375	472	700	850	1100
	50A	-	-	-	-	-	-	-	472	650	800	1000
63A	-	-	-	-	-	-	-	-	650	800	1000	

		m.c.b. upstream										
		DX ³ 25kA										
		B Curve										
m.c.b. downstream		10A	16A	20A	25A	32A	40A	50A	63A	80A	100A	125A
TX ³ 6000A B and C Curves	6A	-	64	80	100	128	160	200	252	800	1000	1300
	10A	-	-	80	100	128	160	200	252	750	960	1200
	16A	-	-	-	-	128	160	200	252	630	800	960
	20A	-	-	-	-	-	160	200	252	600	730	900
	25A	-	-	-	-	-	-	200	252	560	650	850
	32A	-	-	-	-	-	-	200	252	500	630	800
	40A	-	-	-	-	-	-	-	252	460	560	700
	50A	-	-	-	-	-	-	-	-	430	500	650
63A	-	-	-	-	-	-	-	-	-	500	600	

Circuit breaker TX³ 6000 A up to 63 A (1 module per pole)

Cat. N° (s) : 4 039 69 to 4 040 76

5. GENERAL CHARACTERISTICS *(continued)*:

Selectivity between modular circuit breakers:

. Selectivity limit at 400 V~: values in Ampere.

		m.c.b. upstream										
		DX ³ 25kA										
		C Curve										
m.c.b. downstream		10A	16A	20A	25A	32A	40A	50A	63A	80A	100A	125A
TX ³ 6000A B and C Curves	6A	75	120	150	187	240	300	375	472	1300	1600	2000
	10A	-	120	150	187	240	300	375	472	1150	1450	1800
	16A	-	-	150	187	240	300	375	472	950	1200	1500
	20A	-	-	-	187	240	300	375	472	900	1100	1400
	25A	-	-	-	-	240	300	375	472	850	1000	1300
	32A	-	-	-	-	-	300	375	472	750	950	1200
	40A	-	-	-	-	-	-	375	472	700	850	1100
	50A	-	-	-	-	-	-	-	472	650	800	1000
63A	-	-	-	-	-	-	-	-	650	800	1000	

		m.c.b. upstream										
		DX ³ 25kA										
		D Curve										
m.c.b. downstream		10A	16A	20A	25A	32A	40A	50A	63A	80A	100A	125A
TX ³ 6000A B and C Curves	6A	120	192	240	300	384	480	600	756	2000	2400	3000
	10A	-	192	240	300	384	480	600	756	1750	2150	2700
	16A	-	-	240	300	384	480	600	756	1400	1800	2200
	20A	-	-	-	300	384	480	600	756	1350	1650	2100
	25A	-	-	-	-	384	480	600	756	1300	1500	2000
	32A	-	-	-	-	-	480	600	756	1100	1450	1800
	40A	-	-	-	-	-	-	600	756	1000	1250	1650
	50A	-	-	-	-	-	-	-	756	950	1200	1500
63A	-	-	-	-	-	-	-	-	950	1200	1500	

Circuit breaker TX³ 6000 A up to 63 A (1 module per pole)

Cat. N° (s) : 4 039 69 to 4 040 76

5. GENERAL CHARACTERISTICS (continued):

Selectivity between modular circuit breakers:

. Selectivity limit at 400 V~: values in Ampere.

		m.c.b. upstream								
		DX ³ 36kA								
		C Curve								
m.c.b. downstream		10A	16A	20A	25A	32A	40A	50A	63A	80A
TX ³ 6000A B and C Curves	6A	75	120	150	187	240	300	375	472	1300
	10A	-	120	150	187	240	300	375	472	1150
	16A	-	-	150	187	240	300	375	472	950
	20A	-	-	-	187	240	300	375	472	900
	25A	-	-	-	-	240	300	375	472	850
	32A	-	-	-	-	-	300	375	472	750
	40A	-	-	-	-	-	-	375	472	700
	50A	-	-	-	-	-	-	-	472	650
63A	-	-	-	-	-	-	-	-	650	

		m.c.c.b. upstream										
		DPX ³ 160 DPX ³ 160 + diff.								DPX 250ER		
		16 - 25 - 36 - 50kA								25 - 36 - 50kA		
m.c.b. downstream		16A	25A	40A	63A	80A	100A	125A	160A	100A	160A	250A
TX ³ 6000A B and C Curves	6A	T	T	T	T	T	T	T	T	T	T	T
	10A	5000	T	T	T	T	T	T	T	T	T	T
	16A	-	T	T	T	T	T	T	T	T	T	T
	20A	-	5000	5000	5000	5000	T	T	T	T	T	T
	25A	-	-	4500	4500	4500	4500	T	T	5000	T	T
	32A	-	-	-	3000	4000	4000	T	T	4000	T	T
	40A	-	-	-	3000	3000	3000	T	T	3500	T	T
	50A	-	-	-	-	3000	3000	5500	T	3000	5000	T
63A	-	-	-	-	3000	3000	5000	T	2000	5000	5000	

. T = Total discrimination

Circuit breaker TX³ 6000 A up to 63 A (1 module per pole)

Cat. N° (s) : 4 039 69 to 4 040 76

5. GENERAL CHARACTERISTICS (continued):

Selectivity between M.C.Bs and M.C.C.Bs (Moulded Case Circuit Breakers):

. Selectivity limit at 400 V~: values in Ampere.

		m.c.c.b. upstream					
		DPX 250 / H / L (Thermal-Magnetic & electronic)					
		36 - 70 - 100kA					
m.c.b. downstream		25A	40A	63A	100A	160A	250A
TX ³ 6000A B and C Curves	6A	T	T	T	T	T	T
	10A	5000	5000	5000	T	T	T
	16A	4000	4000	4000	T	T	T
	20A	-	4000	4000	T	T	T
	25A	-	3000	3000	T	T	T
	32A	-	-	2000	5000	T	T
	40A	-	-	2000	5000	T	T
	50A	-	-	-	4000	T	T
	63A	-	-	-	4000	T	T

		m.c.c.b. upstream						
		DPX ³ 250 DPX ³ 250 + diff (Thermal-Magnetic & electronic)				DPX / H / L 630 (Thermal-Magnetic & electronic)	DPX / H / L 1250	DPX / H 1600 (electronic)
		25 - 36 - 50 - 70kA				36 - 70 - 100kA	36 - 70 - 100kA	36 - 70kA
m.c.b. downstream		100A	160A	200A	250A	160 to 630A	500 to 1250A	630 to 1600A
TX ³ 6000A B and C Curves	6A	T	T	T	T	T	T	T
	10A	T	T	T	T	T	T	T
	16A	T	T	T	T	T	T	T
	20A	T	T	T	T	T	T	T
	25A	T	T	T	T	T	T	T
	32A	5000	T	T	T	T	T	T
	40A	5000	T	T	T	T	T	T
	50A	4000	T	T	T	T	T	T
	63A	4000	T	T	T	T	T	T

. T = Total discrimination.

Circuit breaker TX³ 6000 A up to 63 A (1 module per pole)

Cat. N° (s) : 4 039 69 to 4 040 76

6. COMPLIANCE AND APPROVALS

In accordance with standards:

- . EN/IEC 60898-1 with 6000 A breaking capacity
- . CEE guidelines : 73/23/CEE + 93/68/CEE
- . Legrand circuit-breakers can be used under the conditions of use as defined by EN/IEC 60947.
- . The performance of circuit breakers can be influenced by particular climates: hot dry, cold dry, hot humid, salt fog atmosphere

Classification according to Annex Q (standard IEC/EN 60947-1) :

- . Category C with a range test temperature -25 °C / +70 °C
- . Salt fog atmosphere according IEC 60068-2-52

Environment respect – Compliance with CEE directives:

- . Compliance with Directive 2002/95/EC of 27/01/03 called "RoHS" which provides for the banning of hazardous substances such as lead, mercury, cadmium, hexavalent chromium, brominated flame retardants polybrominated biphenyls (PBBs) and polybrominated diphenyl ethers (PBDEs) from 1st July 2006
- . Compliance with Directive 91/338/CEE of 18/06/91 and Decree 94-647 of 27/07/04

Plastic materials :

- . Halogens-free plastic materials.
- . Marking of parts according to ISO 11469 and ISO 1043.

Packaging:

- . Design and manufacture of packaging in accordance with Decree 98-638 of 07.20.98 and Directive 94/62/EC

Circuit breaker TX³ 6000 A up to 63 A (1 module per pole)

Cat. N° (s) : 4 039 69 to 4 040 76

7. CHARACTERISTIC CURVES

Limiting current curve: circuit breakers B and C curves:

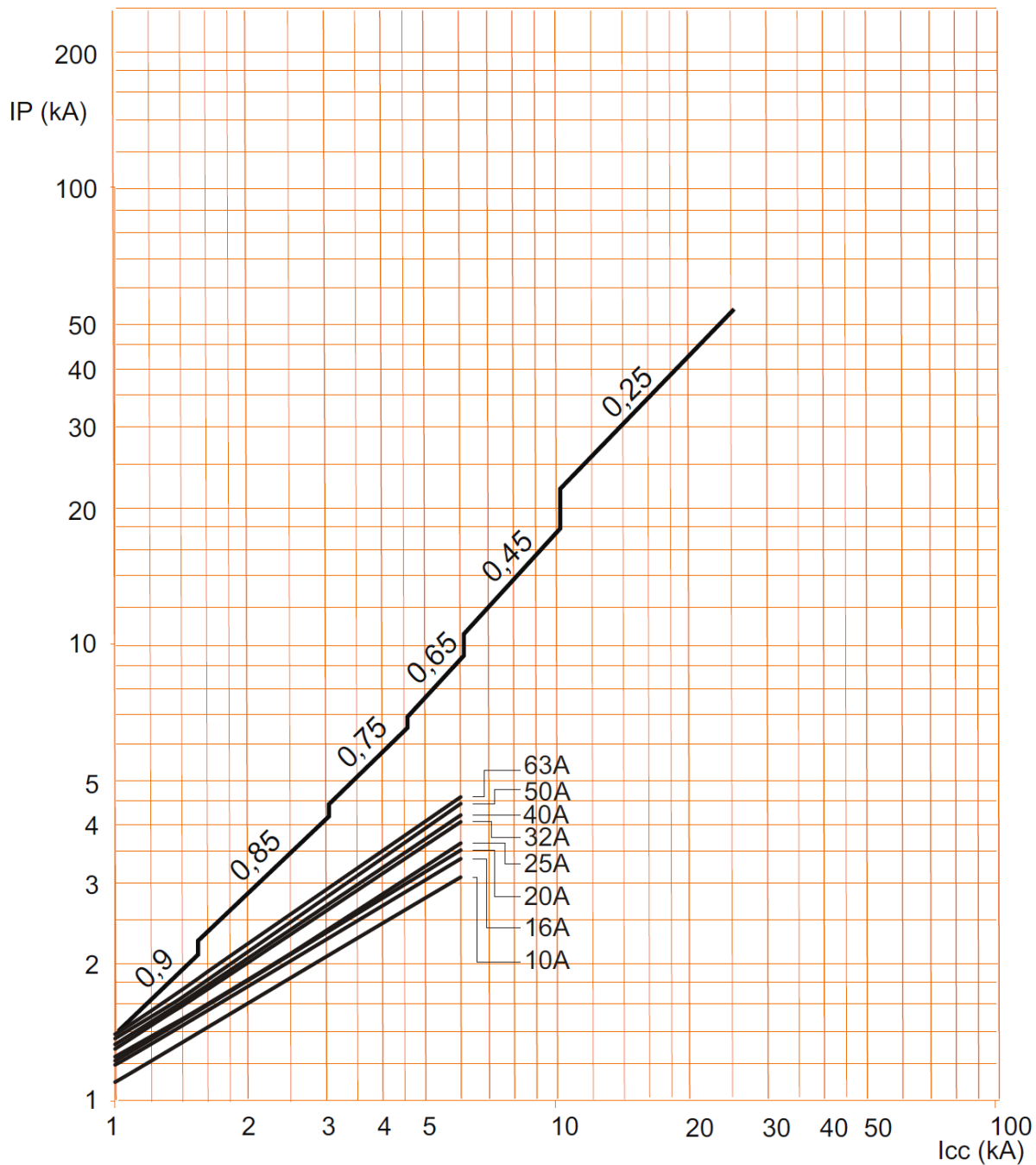

- . Icc = Square value of symmetric component of the short circuit current (kA).
- . IP = Max peak value (kA)

Circuit breaker TX³ 6000 A up to 63 A (1 module per pole)

Cat. N° (s) : 4 039 69 to 4 040 76

7. CHARACTERISTIC CURVES *(continued)*

Operating characteristic of circuit breakers B curve:

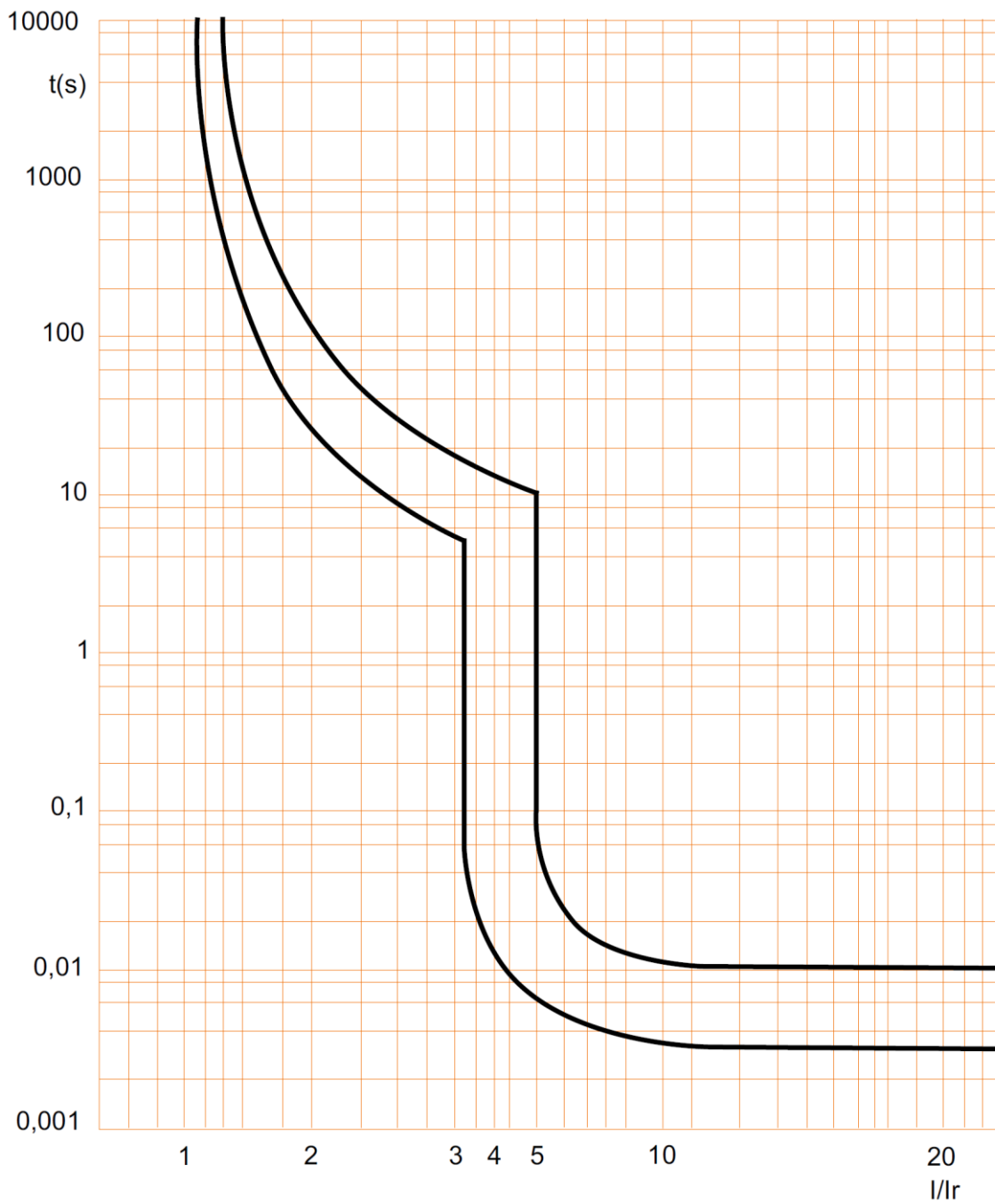

7. CHARACTERISTIC CURVES (continued)

. Limiting thermal energy curve of circuit breakers B curve, 2P (230 V~ / 50 Hz):

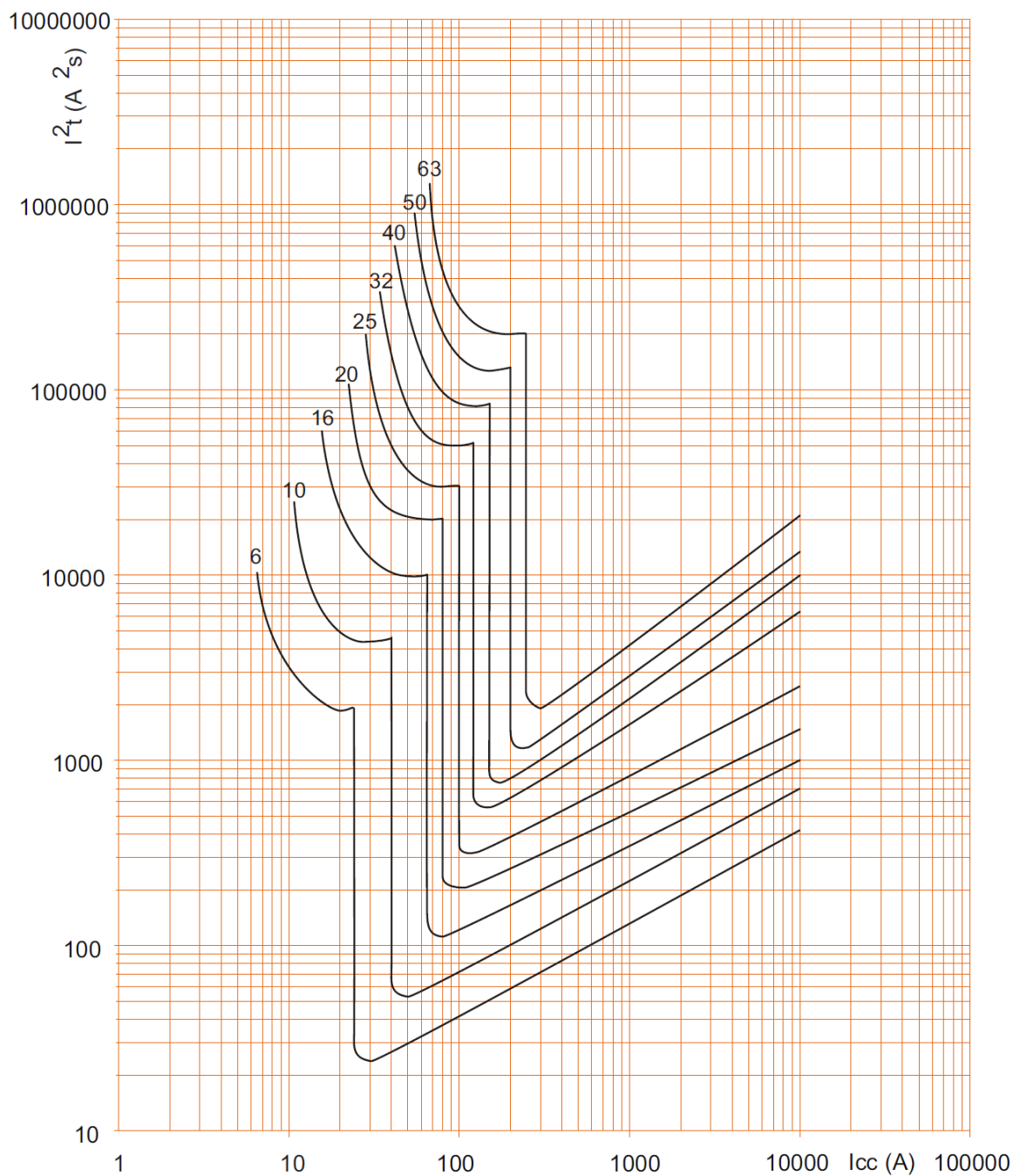

. I_{cc} = Square value of symmetric component of the short circuit current (kA).
. I²t = Thermal energy limited (A²s).

7. CHARACTERISTIC CURVES (continued)

. Limiting thermal energy curve of circuit breakers B curve, 2P (400 V~ / 50 Hz) :

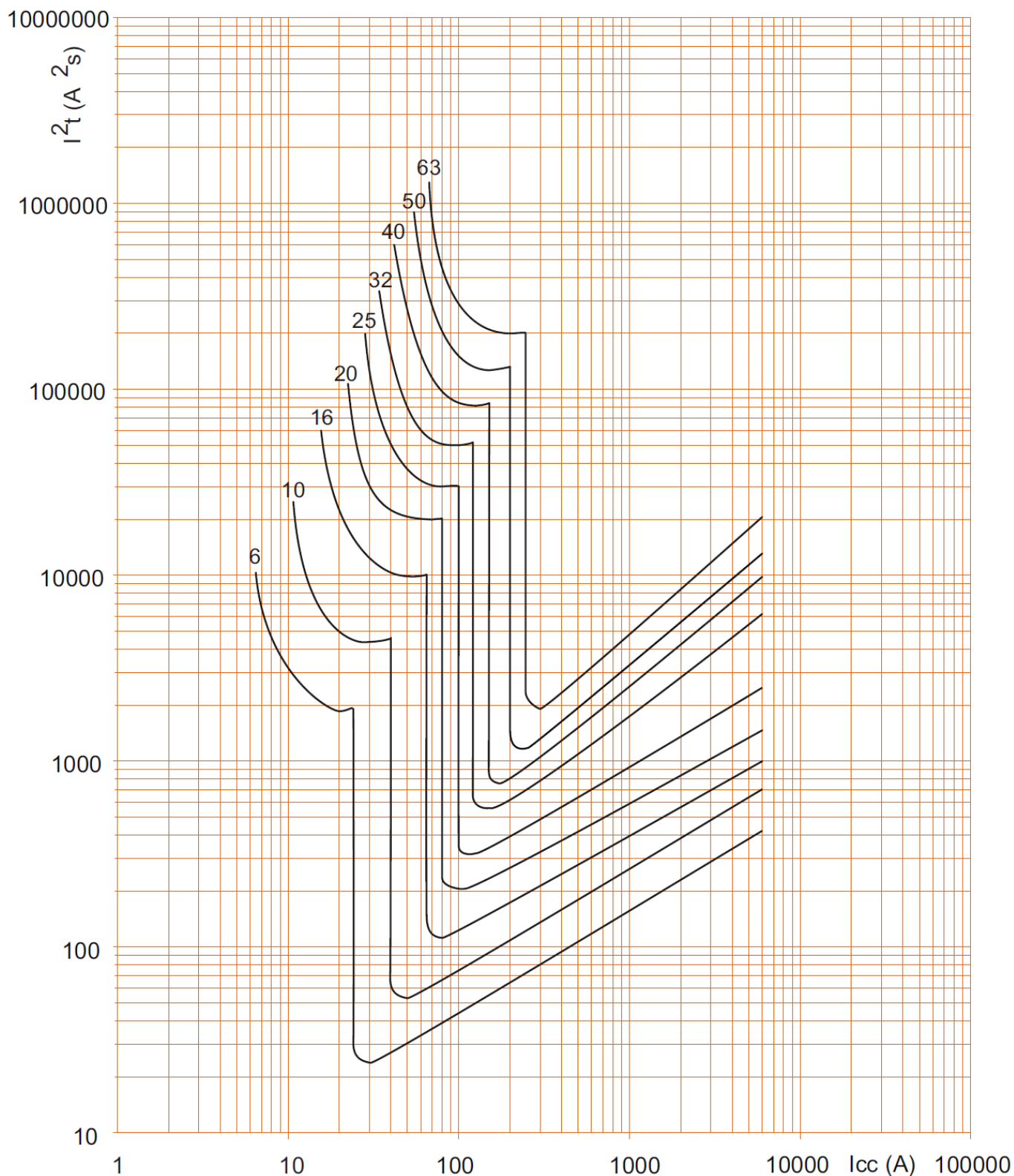

. I_{cc} = Square value of symmetric component of the short circuit current (kA).

. I^2t = Thermal energy limited (A^2s).

7. CHARACTERISTIC CURVES (continued)

. Limiting thermal energy curve of circuit breakers B curve, 1P / 3P / 4P (400 V~ / 50 Hz) :

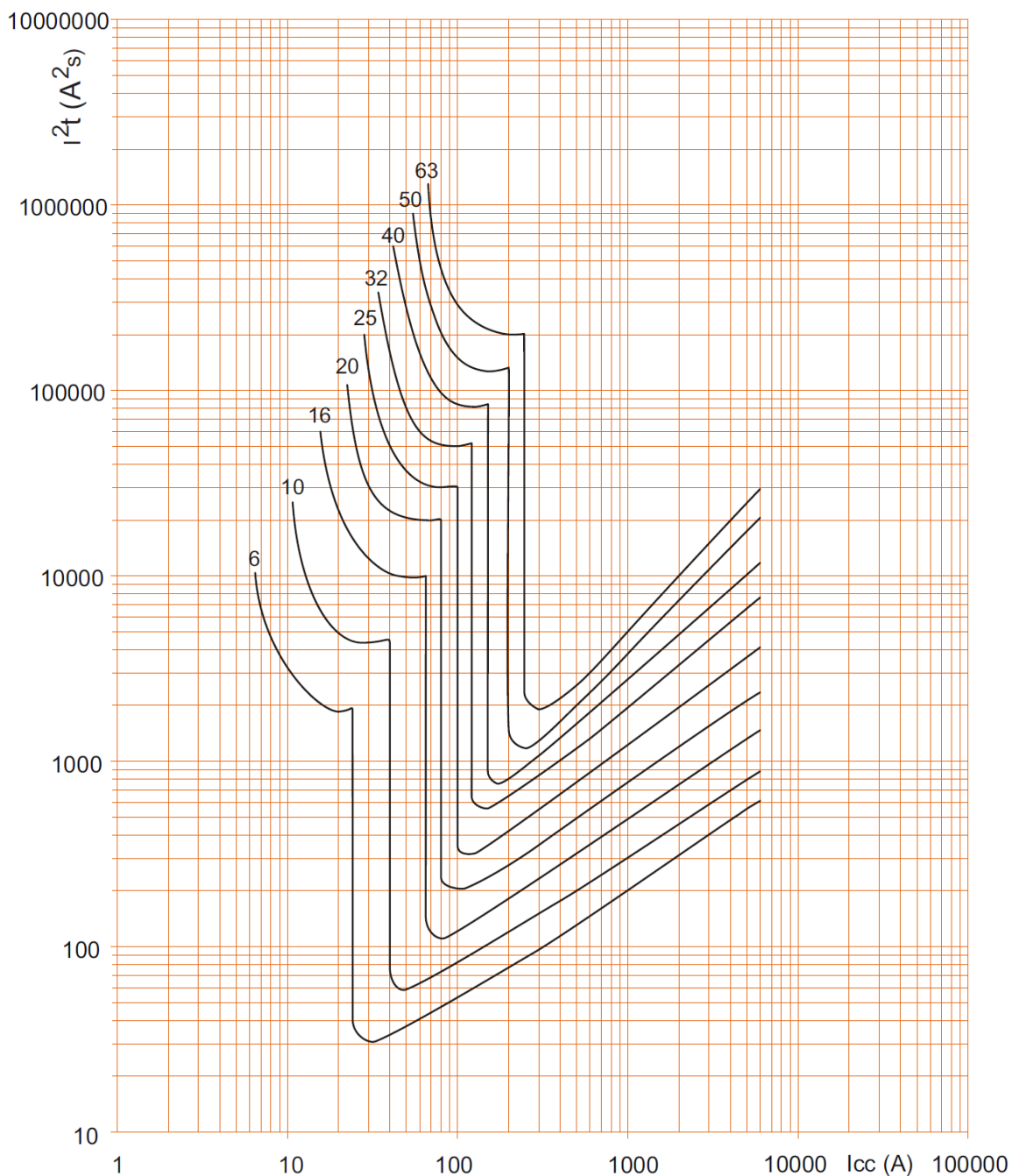

. I_{cc} = Square value of symmetric component of the short circuit current (kA).
. I^2t = Thermal energy limited (A^2s).

Circuit breaker TX³ 6000 A up to 63 A (1 module per pole)

Cat. N° (s) : 4 039 69 to 4 040 76

7. CHARACTERISTIC CURVES *(continued)*

Operating characteristic of circuit breakers C curve:

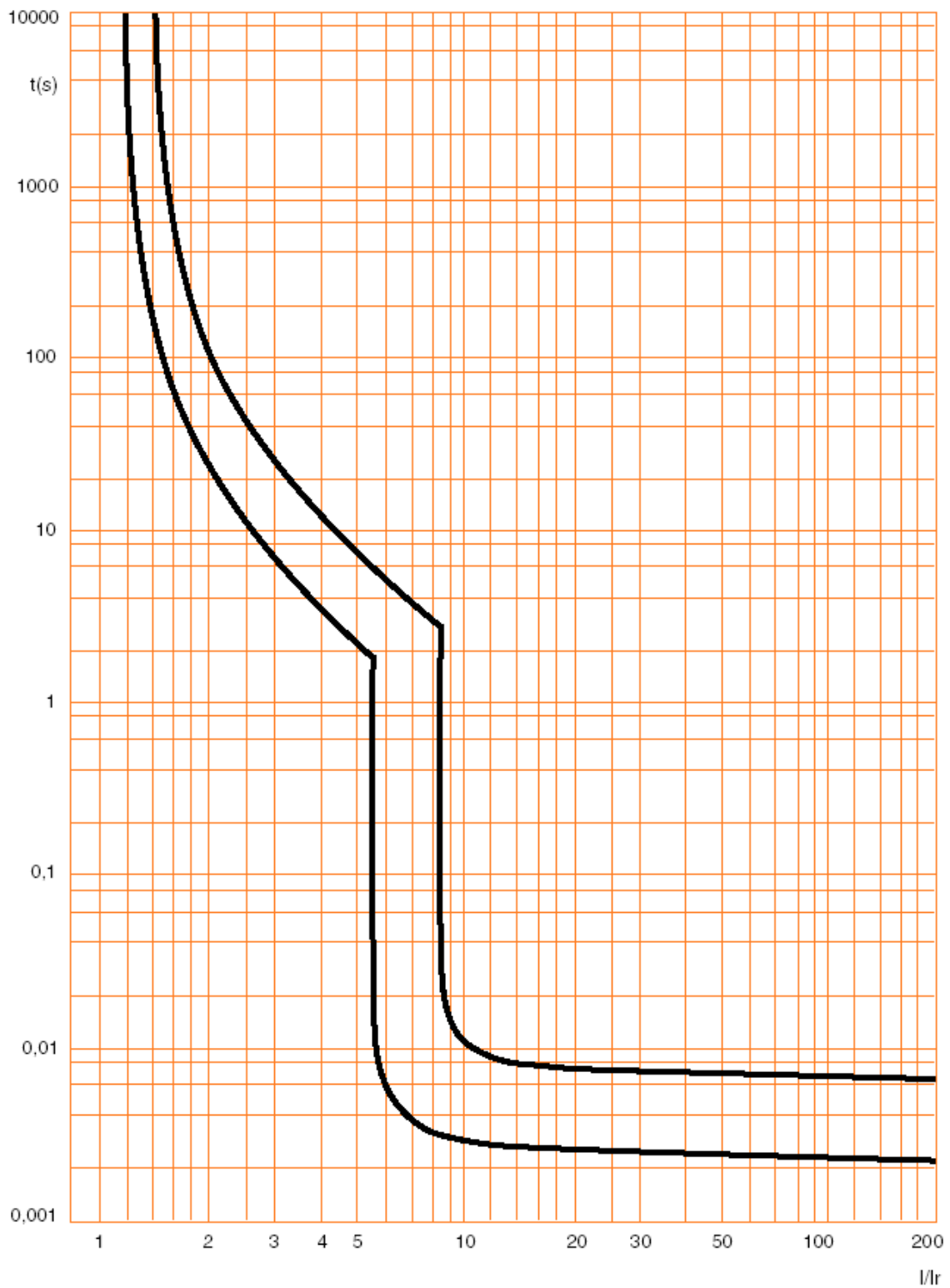

Circuit breaker TX³ 6000 A up to 63 A (1 module per pole)

Cat. N° (s) : 4 039 69 to 4 040 76

7. CHARACTERISTIC CURVES *(continued)*

. Limiting thermal energy curve of circuit breakers C curve, 2P (230 V~ / 50 Hz) :

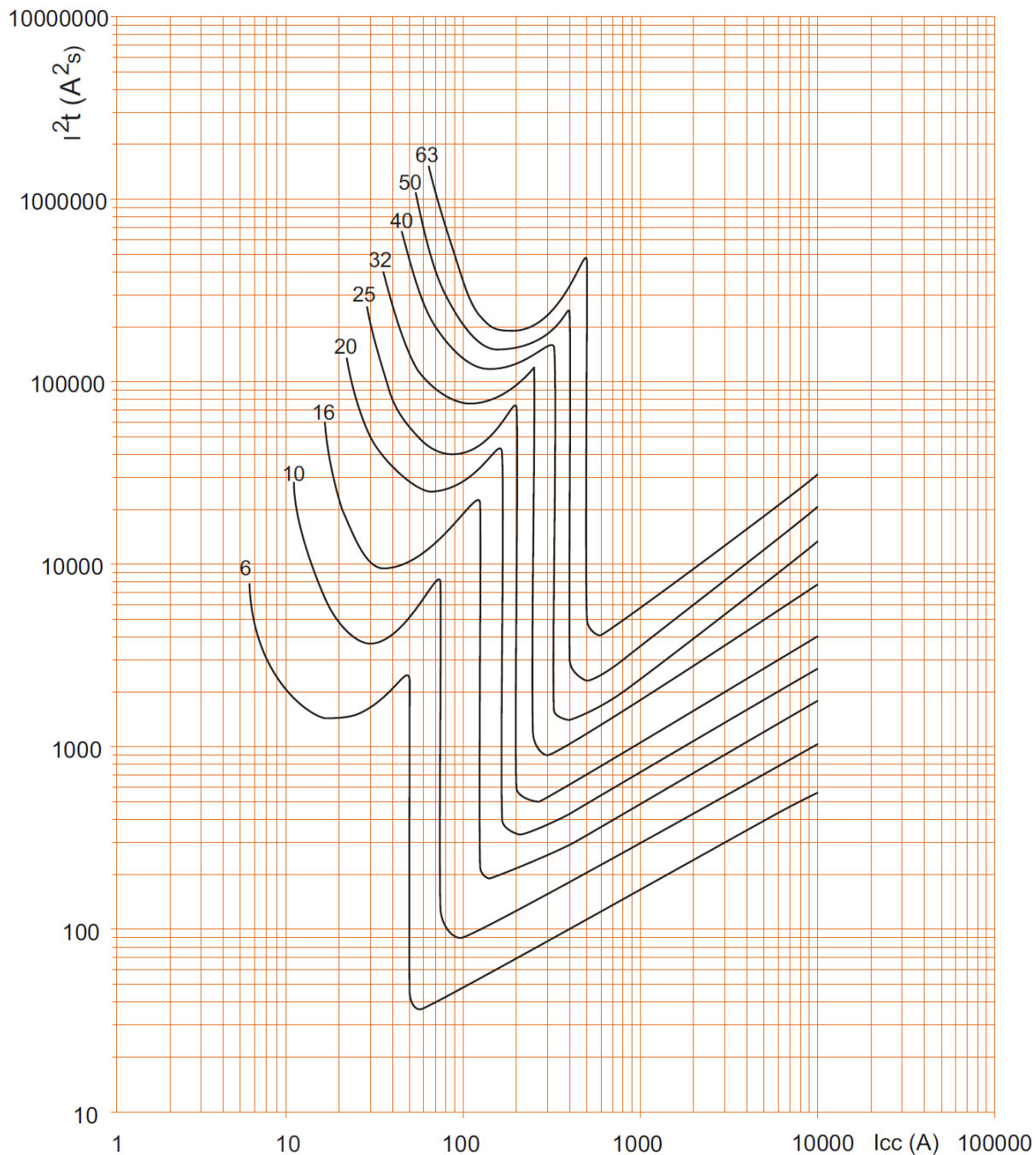

. Icc = Square value of symmetric component of the short circuit current (kA).

. I²t = Thermal energy limited (A²s).

Circuit breaker TX³ 6000 A up to 63 A (1 module per pole)

Cat. N° (s) : 4 039 69 to 4 040 76

7. CHARACTERISTIC CURVES *(continued)*

. Limiting thermal energy curve of circuit breakers C curve, 2P (400 V~ / 50 Hz) :

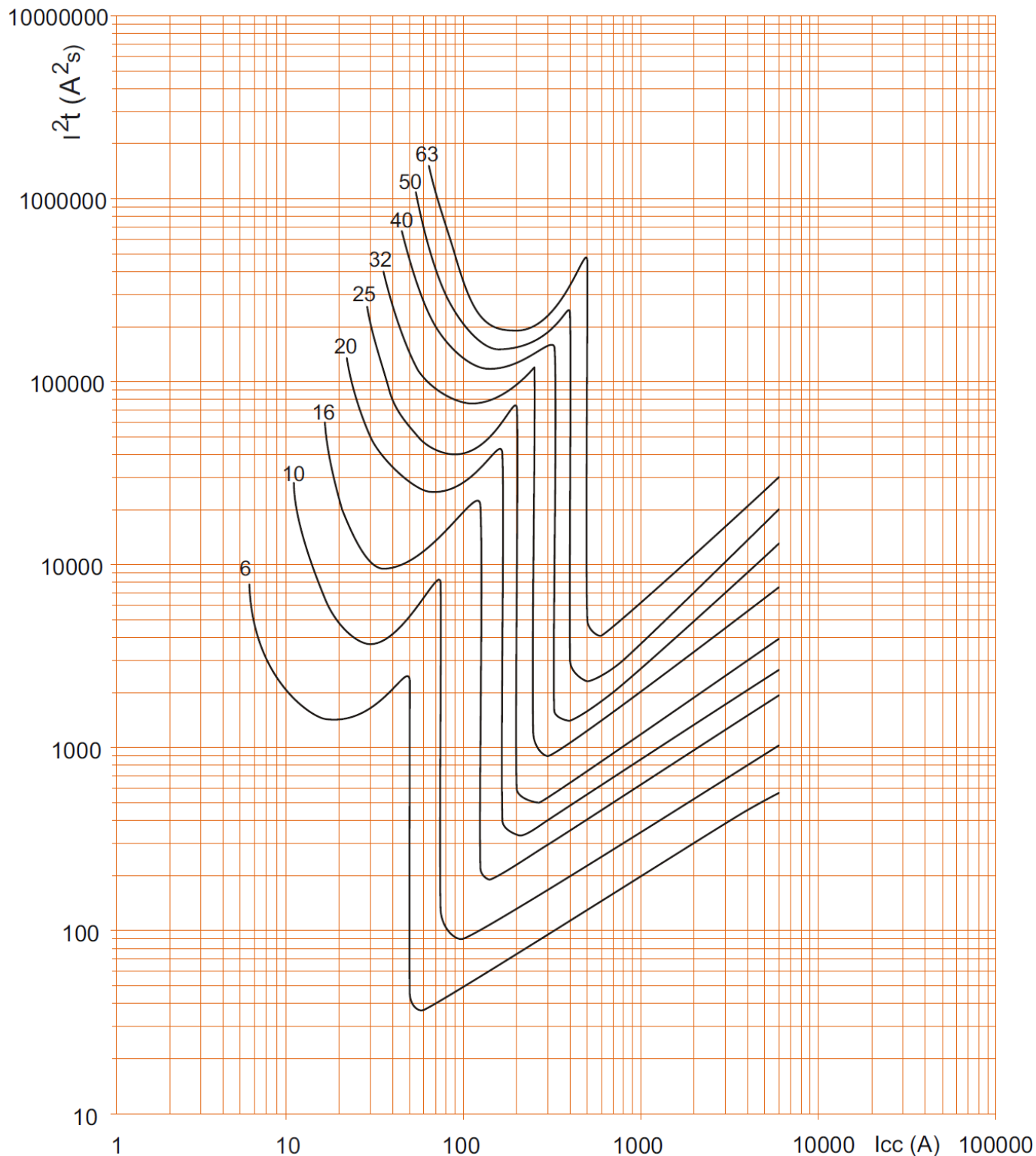

. I_{cc} = Square value of symmetric component of the short circuit current (kA).

. I^2t = Thermal energy limited (A^2s).

Circuit breaker TX³ 6000 A up to 63 A (1 module per pole)

Cat. N° (s) : 4 039 69 to 4 040 76

7. CHARACTERISTIC CURVES *(continued)*

. Limiting thermal energy curve of circuit breakers C curve, 1P / 3P / 4P (400 V~ / 50 Hz) :

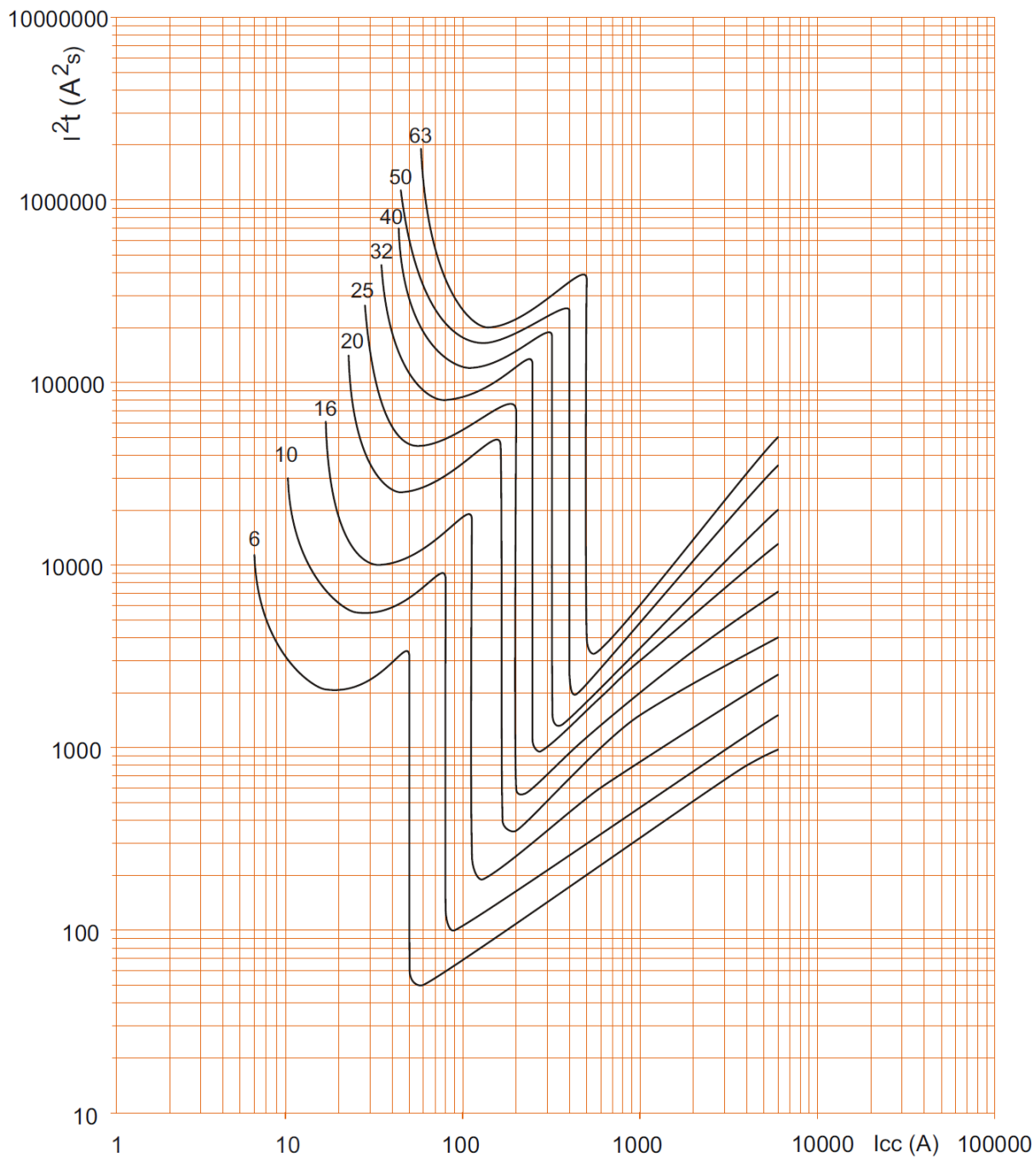

. Icc = Square value of symmetric component of the short circuit current (kA).

. I²t = Thermal energy limited (A²s).

Circuit breaker TX³ 6000 A up to 63 A (1 module per pole)

Cat. N° (s) : 4 039 69 to 4 040 76

8. AUXILIARIES AND ACCESSORIES

Wiring accessories:

- . Pin busbar HX³ traditional.
- . Sealable screw cover (cat n° 4 063 04).
- . Insulating shields (cat n° 4 063 05)
- . Dispatcher row Lexiclic
- . Dispatcher row HX³

Signal auxiliaries:

- . Auxiliary contact (½ module – cat n° 4 062 58).
- . Fault signalling changeover switch (½ module – cat n° 4 062 60).
- . Auxiliary contact modifiable in default signal (½ module – cat n° 4 062 62).
- . Auxiliary contact + fault signalling switch - can be modified to 2 auxiliary contacts (1 module - cat n° 4 062 66).

Control auxiliaries:

- . Shunt releases (1 module - cat n° 4 062 76 /78)
- . Under voltage release (1 module - cat n° 4 062 80 /82)
- . Autonomous shunt trip for NC push-button (1 module - cat n° 4 062 84).
- . Power Overvoltage Protection (1 module – cat n° 4 062 86)

Motor driven control modules

- . Motor driven control module (1 module – cat n° 4 062 91)
- . Motor driven control module with automatic resetting integrated (2 modules – cat n° 4 062 93 /95)

Possible combinations of m.c.b and auxiliaries:

- . Auxiliaries are clipped on the left of the m.c.b.
- . Maximum number of auxiliaries for one circuit-breaker: 3.
- . Two signalling auxiliaries max. (cat. n° 4 062 58 /60 /62 /66).
- . Only one control auxiliary (cat. n° 4 062 76 /78 /80 /82 / 84).
- . One remote control or Stop & Go motor driven remote control
- . If signalling and control auxiliaries are associated on the same circuit breaker, the command auxiliary must be placed to the left of the signal auxiliary

Sealing:

- . Possible in "Open" position (OFF) or "Close" position (ON).

Locking:

- . By 5 mm padlock (cat. N° 4 063 13) or 6 mm padlock (cat. N° 0 227 97) with padlock support (cat. N° 4 063 03).

Installation software:

- . XL PRO³