

DPX³ 250 Electronic + earth leakage

Reference(s):**420 322/ 325/ 327/ 329/ 352/ 355/ 357/ 359/ 420 382/ 385/ 387/ 389/ 655/ 657/ 658/ 659/ 420 422/ 425/ 427/ 429/ 452/ 455/ 457/ 459/ 420 482/ 485/ 487/ 489/ 685/ 687/ 688/ 689/**



CONTENTS	PAGES
1. USE	1
2. RANGE	1
3. DIMENSIONS	1
4. OVERVIEW	2
5. ELECTRICAL AND MECHANICAL CHARACTERISTICS	3
6. CONFORMITY	6
7. EQUIPMENTS AND ACCESSORIES	6
8. CURVES	8

1. USE

DPX³ "moulded case" circuit breaker offers optimal solutions to answer to protection requirements of tertiary and industrial installations.

2. RANGE

Circuit breakers

DPX³ ELECTRONIC + EARTH LEAKAGE

	25 kA	36 kA	50 kA	70kA
I_n (A)	4P	4P	4P	4P
40	4 203 22	4 203 52	4 203 82	4 206 55
100	4 203 25	4 203 55	4 203 85	4 206 57
160	4 203 27	4 203 57	4 203 87	4 206 58
250	4 203 29	4 203 59	4 203 89	4 206 59

DPX³ ELECTRONIC + EARTH LEAKAGE + MEASURE

	25 kA	36 kA	50 kA	70kA
I_n (A)	4P	4P	4P	4P
40	4 204 22	4 204 52	4 204 82	4 206 85
100	4 204 25	4 204 55	4 204 85	4 206 87
160	4 204 27	4 204 57	4 204 87	4 206 88
250	4 204 29	4 204 59	4 204 89	4 206 89

3. DIMENSIONS

Fixed version

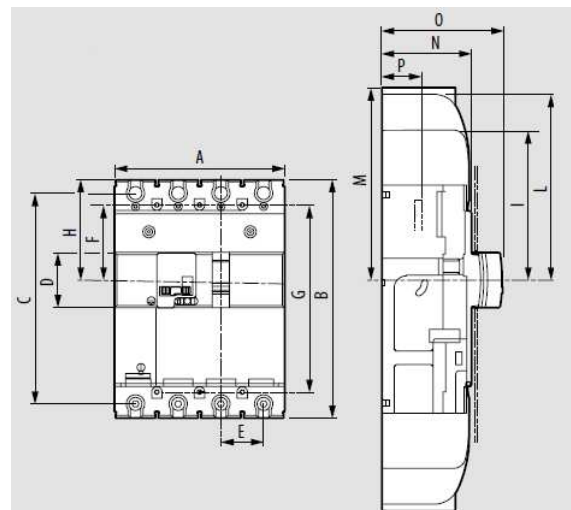

	A	B	C	D	E	F	G	H	I	L	N	O	P
DIFF.	140	195	172,5	45	35	61,5	153	82,5	112,5	150	74	100	18

Fixed version, front terminals

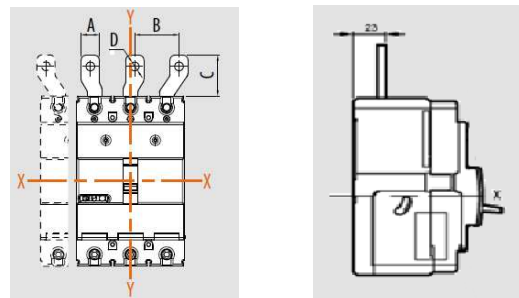

A	B	C	D
33	48,5	54,75	13

DPX³ 250 Electronic + earth leakage

Reference(s): 420 322/ 325/ 327/ 329/ 352/ 355/ 357/ 359/
 420 382/ 385/ 387/ 389/ 655/ 657/ 658/ 659/
 420 422/ 425/ 427/ 429/ 452/ 455/ 457/ 459/
 420 482/ 485/ 487/ 489/ 685/ 687/ 688/ 689/

Fixed version, rear terminals

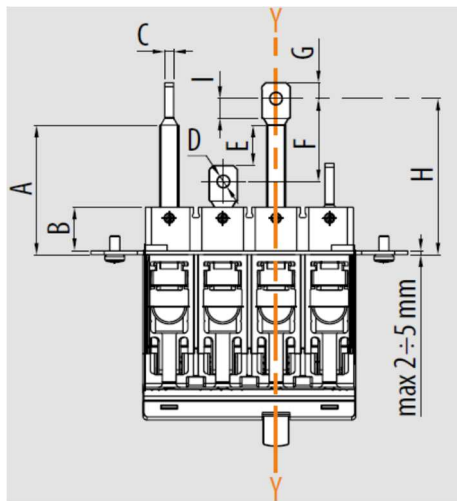

A	B	C	D	E	F	G	H	I
66,5	22	6	8,4	15,5	44	15	79	10

Fixed version, front motor operator

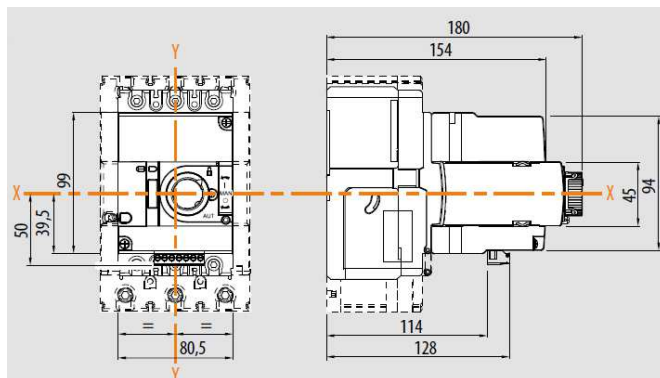

Fixed version, side motor operator

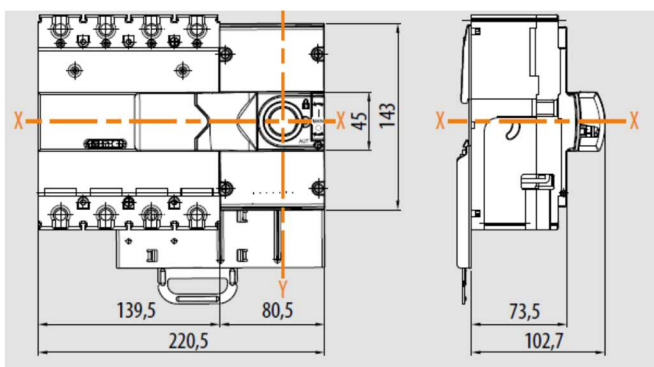

Plug-in version

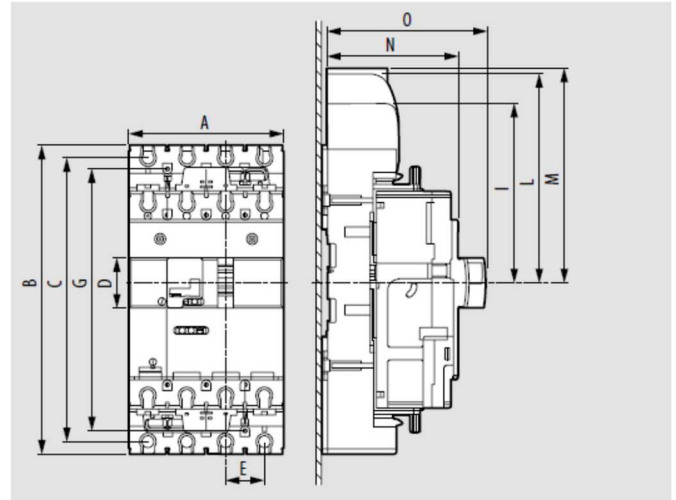

	A	B	C	D	E	F	G	H	I	L	M	N	O
DIFF.	140	278	255,5	45	35	103	236	150	180	217,5	-	122	148

4. OVERVIEW

4.1 Supplied

Supplied with

- fixing screws
- connection plates for bars and cable lugs
- insulating shields (phase barrier)

4.2 Mounting possibilities

On plate:

- Vertical
- Horizontal
- Supply inverter type

On DIN rail:

- Vertical
- Supply inverter type

DPX³ 250 Electronic + earth leakage

Reference(s): 420 322/ 325/ 327/ 329/ 352/ 355/ 357/ 359/
 420 382/ 385/ 387/ 389/ 655/ 657/ 658/ 659/
 420 422/ 425/ 427/ 429/ 452/ 455/ 457/ 459/
 420 482/ 485/ 487/ 489/ 685/ 687/ 688/ 689/

5. ELECTRICAL AND MECHANICAL CHARACTERISTICS

5.1 Main parts constituting the circuit breaker

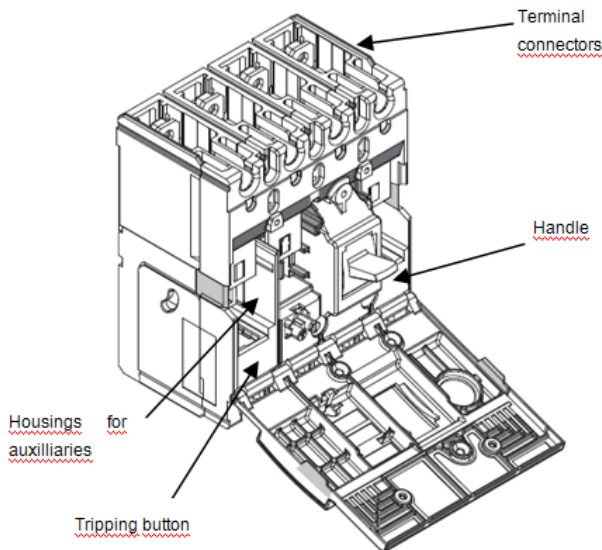

Circuit Breaker	DPX ³ 250 (B/F/N/H) (25kA, 36kA, 50kA, 70kA)
Rated current (A)	40, 100, 160, 250
Poles	3 - 4
Rated insulation voltage U_i (V)	500
Rated operating voltage (50/60Hz) U_e (V)	500
Rated impulse withstand current I_{imp} (kV)	6
Rated frequency (Hz)	50 - 60
Reference ambient temperature (°C)	40 - 50
Operating temperature (°C)	-25 ÷ 70
Mechanical endurance (cycles)	20000
Mechanical endurance with motor control (cycles)	20000
Electrical endurance at I_n (cycles)	8000
Electrical endurance at 0.5 I_n (cycles)	10000
Utilization category	A
Suitable for isolation	Yes
Type of protection	Electronic
Magnetic adjustment	(1,5 - 10) × I_r
Thermal adjustment	(0,4 ÷ 1) × I_n
Neutral protection for 4P version (% I_n)	0-50-100-150-200
Dimensions (W x H x D) (mm) 4P	140 x 195 x 100
Weight (kg)	2.6 (4P)
Earth leakage type	A - Integrated
Adjustable sensitivity (A)	0.03 - 0.3 - 1 - 3
Adjustable tripping (s)	0 - 0.3 - 1 - 3 (with 0.03 A possible only 0 s)

5.2 Breaking capacity (kA)

		Breaking capacity (kA) & I_{cs}			
		3P-4P	3P-4P	3P-4P	3P-4P
IEC 60947-2	U_e/I_{cu}	B	F	N	H
	220/240 V AC	40	60	80	100
	380/415 V AC	25	36	50	70
	440/460 V AC	20	30	40	60
	480/500 V AC	8	16	18	20
	I_{cs} (% I_{cu})	100	100	100	100
Rated making capacity under short circuit I_{cm}					
	I_{cm} (kA) at 415V	52.5	75.6	105	154
NEMA AB-1	220/240 V AC	40	60	80	100
	480/500 V AC	8	16	18	20

5.3 Rated current (I_n) at 40°C / 50°C

I_n (A)	Assigned current trip			
	thermal		magnetic	
	L1-L2-L3	N	L1-L2-L3	N
40	40	40	400	400
100	100	100	1000	1000
160	160	160	1600	1600
250	250	250	2500	2500

5.4 Power losses per pole under I_n

Circuit breaker

Lugs	Power losses per pole (W)			
	I_n (A)			
	40	100	160	250
	1.3	2.1	7.3	17.8

Values in the table are referred to single phase and they are misured with cold breaker (with hot breaker, increase of 10% must be considered)

5.5 Load operations

Loads operation	
Rated current (A)	$I_n = 250A$
Opening (N)	45
Closing (N)	78
Reset (N)	75

DPX³ 250 Electronic + earth leakage

Reference(s): 420 322/ 325/ 327/ 329/ 352/ 355/ 357/ 359/
 420 382/ 385/ 387/ 389/ 655/ 657/ 658/ 659/
 420 422/ 425/ 427/ 429/ 452/ 455/ 457/ 459/
 420 482/ 485/ 487/ 489/ 685/ 687/ 688/ 689/

5.6 Functioning in particular conditions

5.6.1 Temperature

I _n (A)	Temperature T _a (°C)			
	40	50	60	70
40	40	40	34	30
100	100	100	84	76
160	160	160	134	122
250	250	250	210	190

5.6.2 Altitude

Altitude (m)	2000	3000	4000	5000
U _e (V)	500	430	380	330
I _n (A) (T _a = 40°C/50°C)	I _n	0.98 x I _n	0.93 x I _n	0.9 x I _n

5.6.3 Use at 400 Hz

Not possible with electronic release.

5.5 ELECTRONIC RELEASES

5.5.2 Version S2 - Adjustment of I_r, T_r, I_{sd}, T_{sd}

LCD display with navigation and setting buttons, indication led, battery case and USB port.

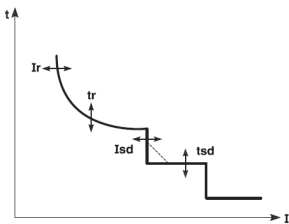

Long delay protection against overloads with an adjustable threshold bases on the RMS value of the current:

- I_r = 0.4 ÷ 1 I_n (steps 1A)
- T_r = 3 - 15s (3 - 5 - 10 - 15 3^{MEM} - 5^{MEM} - 10^{MEM} - 15^{MEM}) (8 steps) (*)

Short delay protection against short-circuits with an adjustable I_{sd} threshold:

- I_{sd} = 1.5 - 2 - 2.5 - 3 - 4 - 5 - 6 - 7 - 8 - 9 - 10 x I_r (11 steps)
- T_{sd} = 0 - 100ms - 200ms - 300ms - 400 ms - 500 ms (I = K)
- T_{sd} = 0 - 100ms - 200ms - 300ms - 400 ms - 500 ms (I²t = K) (**)

Instantaneous protection with fixed threshold I_{sf} = 3kA

Residual current against earth

Measure of ground fault:

- I_{Δn} : 30mA - 300mA - 1A - 3A (4 steps)
- Δt : 0s - 300ms - 1s - 3s (4 steps)

(*) @ 6 I_r

(**) @ 12 I_r

Setup mode

Setting I_{Δn}:

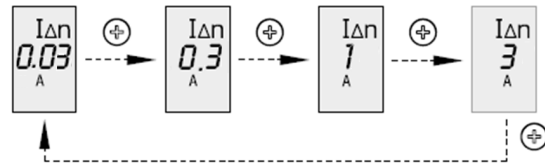

Setting t:

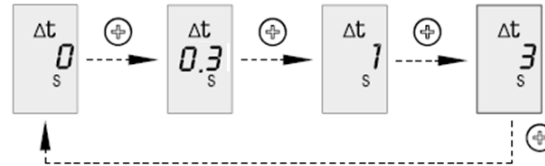

ATTENTION: after 5" of permanence on display of the new protection value I_{Δn} or time Δt, it is automatically set.

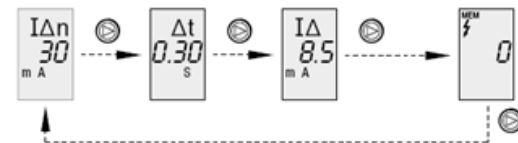

I_{Δn} value set Δt value set IΔ measured value present History of interventions for differential intervention

General remarks on protection unit

The protection units S2/Sg are normally supplied by the current transformers (CTs) and the internal voltage supply.

When the current flowing through the circuit breaker is lower than 12% of the maximum power (20% of I_n for single phase load) the internal voltage supply assures the following basic functions of protection unit: RCD protection, LED status, display indication (without backlight) and RCD diagnostic trip test (T button).

Instead, over the 12% of the maximum power (20% of I_n for single phase load), the additional power provided by current transformers ensures the complete functions of the protection unit, included diagnostic functions (e.g. trip test). Display backlight and integrated measure (if available) are instead guaranteed starting from 20% of the maximum power (35% of I_n for single phase load), in absence of any other supply. In any case the external power supply is strongly recommended for the correct working of measurement, as well as RS485 communication.

To ensure the same performance when the load is less than 12% of the maximum power (20% of I_n for single phase load) to grant complete functions, one of the following optional power supplies can be used:

- external Auxiliary power supplier or, alternatively, Modbus communication interface;
- power supply temporarily connected to frontal USB socket, connected to a 5V DC power bank or PC

DPX³ 250 Electronic + earth leakage

Reference(s): 420 322/ 325/ 327/ 329/ 352/ 355/ 357/ 359/
 420 382/ 385/ 387/ 389/ 655/ 657/ 658/ 659/
 420 422/ 425/ 427/ 429/ 452/ 455/ 457/ 459/
 420 482/ 485/ 487/ 489/ 685/ 687/ 688/ 689/

Together with above protections, activated in case of electric faults, the trip unit also integrates self-protection for:

- Over temperature : in case the internal temperature of protection unit exceed 95°C;
- Auto diagnostics: in case embedded watchdog circuit detects internal malfunctions, which could compromise the correct working of microcontroller.

5.5.3 Version S2 with measure

In the electronic unit protection, an energy metering central unit is integrated.

The possible parameters that can be measured are listed in the following table:

Measured	UNIT	DESCRIPTION
I ₁	A	L1 realtime measured value
I ₂	A	L2 realtime measured value
I ₃	A	L3 realtime measured value
I _N (4P)	A	N realtime measured value
I _G	A	G realtime measured value
U ₁₂ U ₂₃ U ₃₁ (3P)	V	Phase to Phase Voltage
V ₁₂ V ₂₃ V ₃₁ (4P)	V	Voltage
Freq.	Hz	Frequency
P _{Tot}	kW	Active Power
Q _{Tot}	kvar	Reactive Power
PF		Power Factor
E _p ↓	kWh	Consumed active energy
E _p ↑	kWh	Returned active energy
E _q ↓	kvar h	Consumed reactive energy
E _q ↑	Kvar h	Returned reactive energy
THDU ₁₂ /THDU ₂₃ /THDU ₃₁ (3P)	%	Chained Voltage THD
THDV _{1N} /THDV _{2N} /THDV _{3N} (4P)	%	Voltage THD
THDI ₁ /THDI ₂ /THDI ₃ /THDI _N	%	Current THD
MEM	A - °C	Cause of the last intervention and its value

Function performance class according to IEC 61557-12

Function symbol	Performance class	Measurement range				Other complementary characteristics			
		DPX ³ 250A				I _{max} PMD			
I _n		40A	100A	160A	250A	40A	100A	160A	250A
P	2	0.05kW	0.05kW	0.05kW	0.05kW	48A	120A	192A	300A
Q _a , Q _v	2	0.1kvar	0.1kvar	0.1kvar	0.1kvar	I _b =40A, U _n =400V, f _n =50Hz			
		58kW	144kW	230kW	360kW	I _b =40A, U _n =400V, f _n =50Hz			
E _a	2	0...9999 GWh				48A	120A	192A	300A
E _{rA} , E _v	2	0...9999 GW/h				I _b =250A, U _n =400V, f _n =50Hz			
						48A	120A	192A	300A
f	0.1	50...60 Hz				-			
I	1	2A	2A	2A	2A	48A	120A	192A	300A
		48A	120A	192A	300A	I _b =250A, U _n =400V, f _n =50Hz			
I _N	1	2A	2A	2A	2A	48A	120A	192A	300A
		48A	120A	192A	300A	I _b =250A, U _n =400V, f _n =50Hz			
U	0.5	88...690V				-			
P _{FV}	0.5	-				48A	120A	192A	300A
THDu	5	110...690V				-			
THDi	5	40A	40A	40A	40A	-			
		40A	100A	160A	250A	-			

DPX³ 250 Electronic + earth leakage

Reference(s): 420 322/ 325/ 327/ 329/ 352/ 355/ 357/ 359/
 420 382/ 385/ 387/ 389/ 655/ 657/ 658/ 659/
 420 422/ 425/ 427/ 429/ 452/ 455/ 457/ 459/
 420 482/ 485/ 487/ 489/ 685/ 687/ 688/ 689/

6. CONFORMITY

DPX³ range of product concerning circuit-breakers and switch-disconnectors are in full compliance with the EN/IEC standard 60947-2 and 60947-3 respectively.

The certificate are issued by LOVAG and/or by IECEE CB-scheme certification scheme.

All the product range are CE, CCC, EAC, ANCE marked.

DMX³ are full in compliance with the Shipping Register of Lloyds, RINA, Bureau Veritas, Germanische Lloyds, Norske Veritas and ABS.

" Tropical climate" :

- execution II (all climates) according to IEC 60947-1 Annex Q, Cat. F.

6.1 Marking

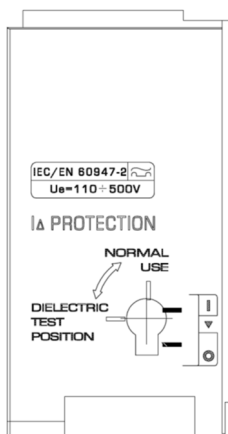
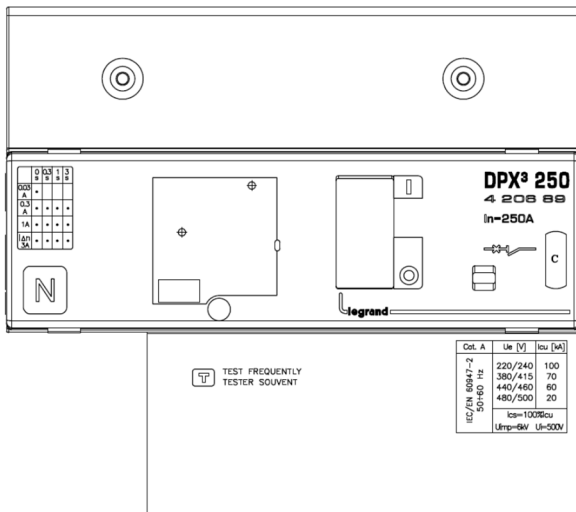

7. EQUIPMENTS AND ACCESSORIES

7.1 Releases

- Shunt releases

12 V ac/dc	ref. 4 210 12
24 V ac/dc	ref. 4 210 13
48 V ac/dc	ref. 4 210 14
110-130 V ac	ref. 4 210 15
200-277 V ac	ref. 4 210 16
380-480 V ac	ref. 4 210 17

Maximum power = 400 VA / W

- Undervoltage releases

12 V ac/dc	ref. 4 210 18
24 V ac/dc	ref. 4 210 19
48 V ac/dc	ref. 4 210 20
110-130 V ac/dc	ref. 4 210 21
200-240 V ac	ref. 4 210 22
277 V ac	ref. 4 210 23
380-415 V ac	ref. 4 210 24
440-480 V ac	ref. 4 210 25

Maximum power = 4 VA

Circuit breaker opening time < 50 ms

- Time-lag undervoltage releases (800ms)

Time-lag modules with voltage:

230 V ac	ref. 0 261 90
400 V ac	ref. 0 261 91

Release:

To be equipped with a time-lag module

ref. 4 210 98

7.2 Auxiliary contact

set of connectors for aux contacts

aux contacts (1NC and 1 NO) for all rotary handles

signalling contact plugged-in version

Changeover switch 3A – 250 VAC

ref. 4 210 44

ref. 4 210 10

ref. 4 210 48

ref. 4 210 11

To show the state of the contacts or opening of the DPX³ on a fault:

Auxiliary contact (standard)

Fault signal

OC

CTR

Auxiliary contact		
Nominal voltage (V _n)	V (AC or DC)	24 to 250
Intensity (A)	24 V DC	5
	48 V DC	1.7
	110 V DC	0.5
	230 V DC	0.25
	110 V AC	4
	230/250 V AC	3

Configurations:

DPX³ 250 → 1 auxiliary contact + 1 fault signal

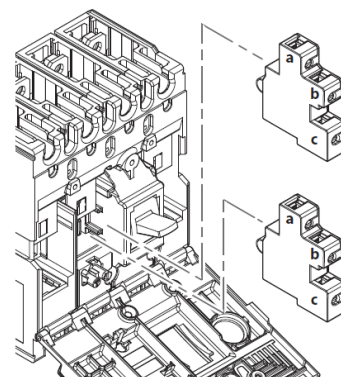

DPX³ 250 Electronic + earth leakage

Reference(s): 420 322/ 325/ 327/ 329/ 352/ 355/ 357/ 359/
420 382/ 385/ 387/ 389/ 655/ 657/ 658/ 659/
420 422/ 425/ 427/ 429/ 452/ 455/ 457/ 459/
420 482/ 485/ 487/ 489/ 685/ 687/ 688/ 689/

7.3 Rotary handles

Direct

- DPX³ direct rotary handle ref. 4 210 00
- DPX³ emergency direct rotary handle ref. 4 210 02

Vari-depth handle IP55

- DPX³ vari depth rotary handle ref. 4 210 04
- DPX³ emergency vari depth rotary handle ref. 4 210 05

Locking accessories

- Ronis type flat key random for direct rotary handle ref. 4 210 06
- Profalux type star key random for direct rotary handle ref. 4 210 07
- Ronis type flat key random for vari-depth handle ref. 4 210 08
- Profalux type star key random for vari-depth handle ref. 4 210 09
- Ronis type flat key (cod. EL43525) for direct rotary handle ref. 4 228 00
- Ronis type flat key (cod. EL43363) for direct rotary handle ref. 4 228 01
- Ronis type flat key (cod. EL43525) for vari-depth handle ref. 4 228 02
- Ronis type flat key (cod. EL43363) for vari-depth handle ref. 4 228 03

7.4 Mechanical accessories

Insulated shields (phase barriers)

- Set of 36 ref. 4 210 70

Sealable terminal shields

- sealable terminal shield for rear terminals 3P ref. 4 210 52
- sealable terminal shield for rear terminals 4P ref. 4 210 53
- sealable terminal shield for front spreaders 3P ref. 4 210 56
- sealable terminal shield for front spreaders 4P ref. 4 210 57

Padlocks

- DPX³ padlock accessory for handle ("open" position) ref. 4 210 49

Interlock

- DPX³ interlock for fixed version ref. 4 210 58
- DPX³ interlock for plug-in / draw-out version ref. 4 210 59

7.5 Connection accessories

Cage terminals

- terminals for Cu/Al cables kit (3P) - flex 1x120mm², rigid 1x150mm², lugs 28.5 x 8 x 8.5mm ref. 4 210 30
- terminals for Cu/Al cables kit (4P) - flex 1x120mm², rigid 1x150mm², lugs 28.5 x 8 x 8.5mm ref. 4 210 31
- screw terminals for bar connections (3P) ref. 4 210 79
- screw terminals for bar connections (4P) ref. 4 210 80

Front spreaders

- DPX³ front spreaders for 3P DPX³ 250 (set of 3) ref. 4 210 34
- DPX³ front spreaders for 4P DPX³ 250 (set of 4) ref. 4 210 35

Rear terminals

- DPX³ flat rear terminals for 3P DPX³ 250 (set of 3) ref. 4 210 38
- DPX³ flat rear terminals for 4P DPX³ 250 (set of 4) ref. 4 210 39

7.6 Plug-in version

Bases

- front/rear terminals plug-in base 3P DPX³ 250 ref. 4 210 42
- front/rear terminals plug-in base 4P (with or without earth leakage module) ref. 4 210 43

Locking accessories

- Ronis type flat key (cod. ABA90GEL6149) for plug-in base ref. 4 210 45
- Profalux type star key (cod. HBA90GPS6149) for plug-in base ref. 4 210 46
- padlock accessory for plug-in base ref. 4 210 47

7.7 Motor operator

- side motor operator 24-230 Vac/dc ref. 4 210 60
- front motor operator 24-230 Vac/dc ref. 4 210 61

Locking accessories for front motor operator

- Ronis type flat key (cod. ABA90GEL6149) for front motor operator ref. 4 210 62
- Profalux type flat key (cod. HBA90GPS6149) for front motor operator ref. 4 210 63
- padlock selector for front motor operator ref. 4 210 64

Locking accessories for side motor operator

- Ronis type flat key (cod. ABA90GEL6149) for side motor operator ref. 4 210 65
- Profalux type flat key (cod. HBA90GPS6149) for side motor operator ref. 4 210 66
- padlock selector for side motor operator ref. 4 210 67

7.8 Mounting on rail fixing plate

- DPX³ 250 3P/4P without earth leakage module ref. 4 210 72
- DPX³ 160 3P/4P with side mounting motor operator ref. 4 210 69

7.9 Spare parts

- Fixing screws (set of 4) for plate installation ref. 4 210 81
- Battery kit (batteries + extractor) for 1 breaker ref. 4 210 82
- Fixing screws (set of 12) for DIN installation ref. 4 210 84
- Mini USB cap (for 20 device) - light grey colour ref. 4 210 89
- Plug-in base kit (for 1 breaker 3P or 4P) ref. 4 210 91
- Compact terminal shields 4P (set of 2) ref. 4 210 97
- Generic seals kit (for 4x seal kit) ref. 4 210 95

8. CURVES

8.1 Thermal magnetic tripping curve

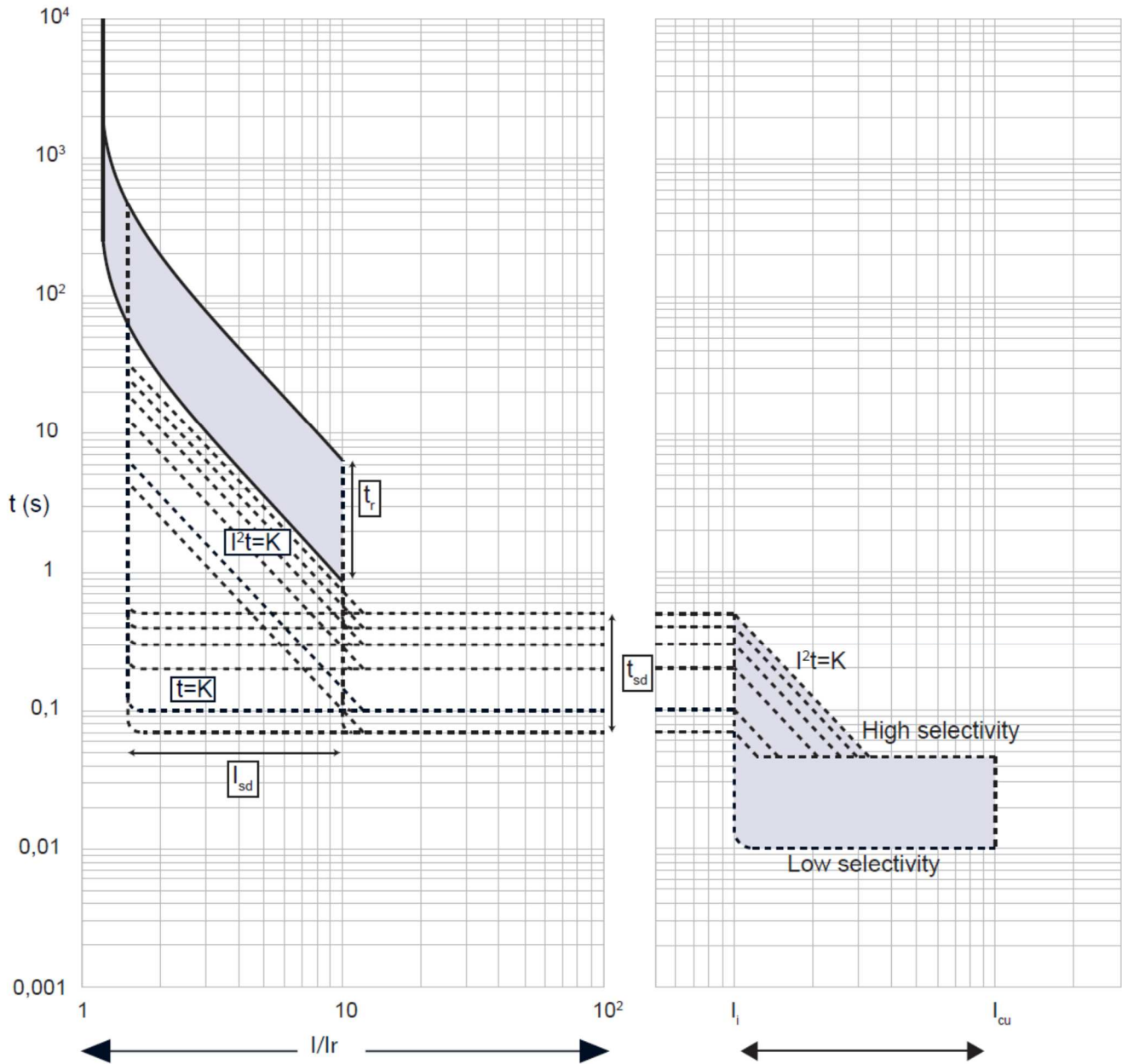

$I_{cu} = 25-36-50-70 \text{ kA}$ $I_{max} = 250 \text{ A}$ 3-4 P $U_e = 415 \text{ Vac}$

Value	Description
t	time
I	current
I_n	rated current
I_r	long time setting current
curve 1	characteristic with cold start
curve 2	characteristic with hot start

8.2 Pass-through specific energy characteristic curve

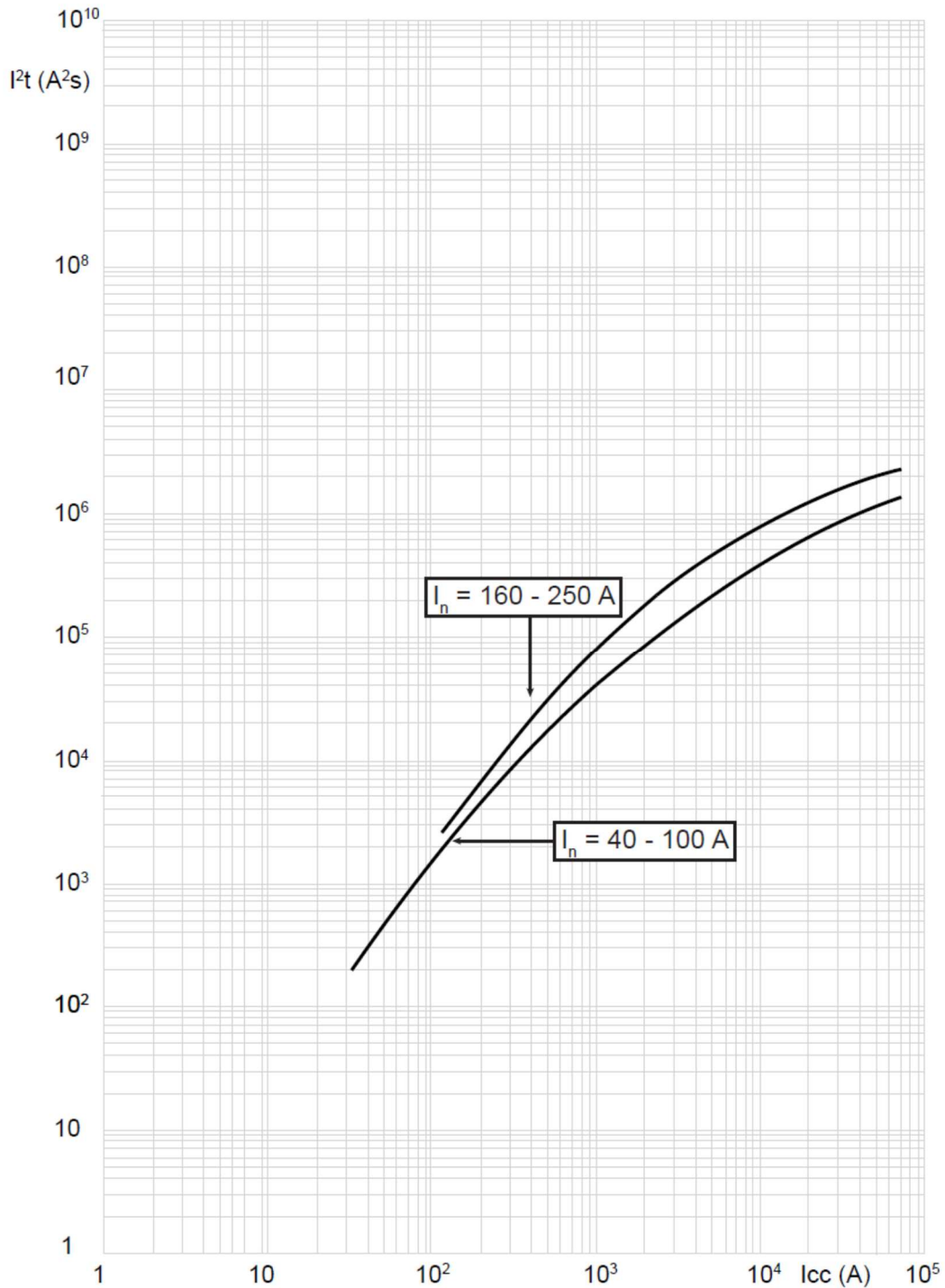

$I_{cu} = 25-36-50-70 kA$ $I_{max} = 250A$ 3-4 P $U_e = 415Vac$

Value	Description
I_{cc}	short circuit current
$I^2t (A^2s)$	pass-through specific energy

8.3 Cut-off peak current characteristic curve (kA)

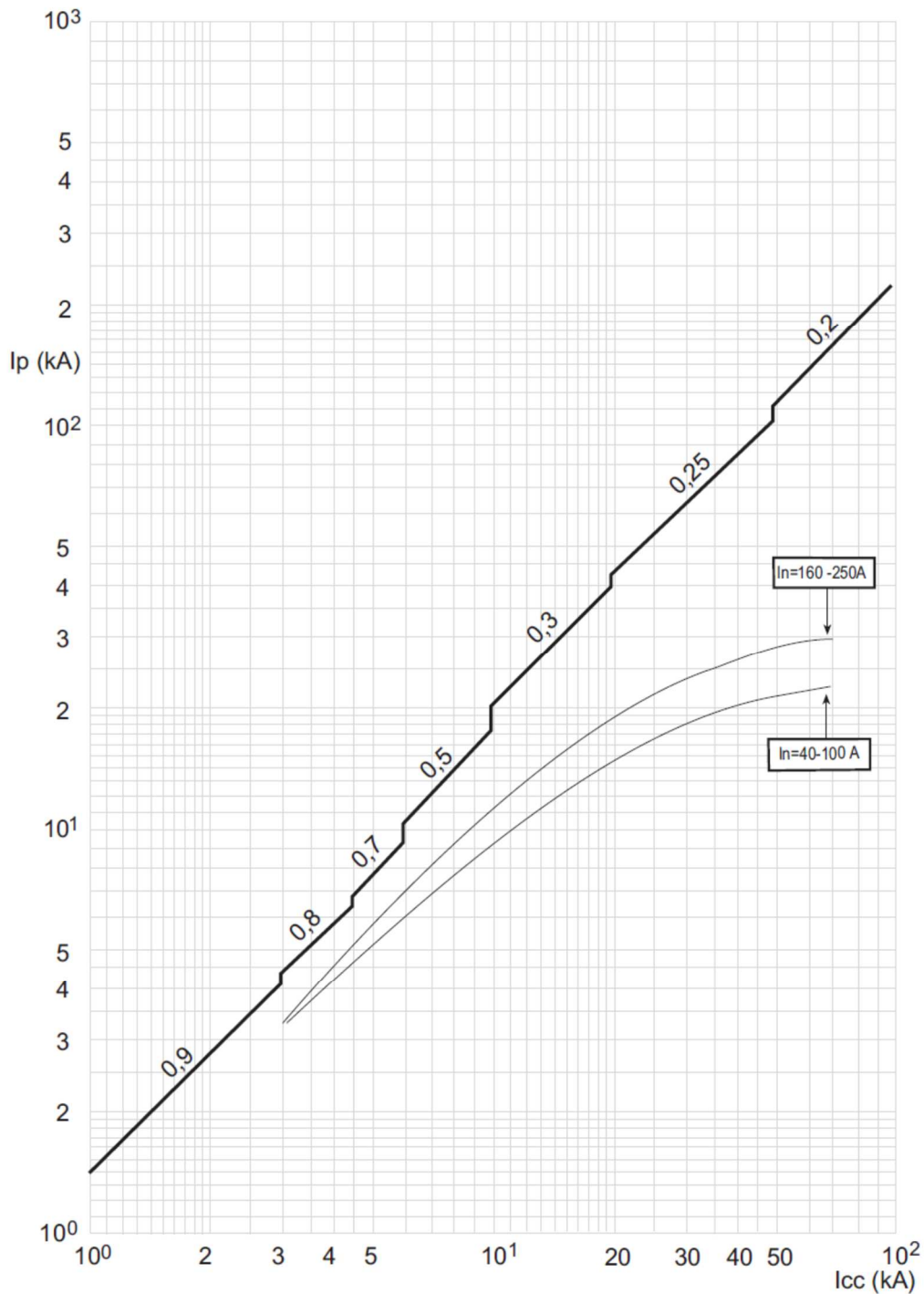

$I_{cu} = 25-36-50-70 \text{ kA}$ $I_{max} = 250A$ 3-4 P $U_e = 415Vac$

Value	Description
I_{cc}	estimated short circuit symmetrical current (RMS value)
I_p	maximum short circuit peak current
	maximum prospective short circuit peak current corresponding at the power factor
	maximum real peak short circuit current

9.4.1 Earth leakage curve, instantaneous

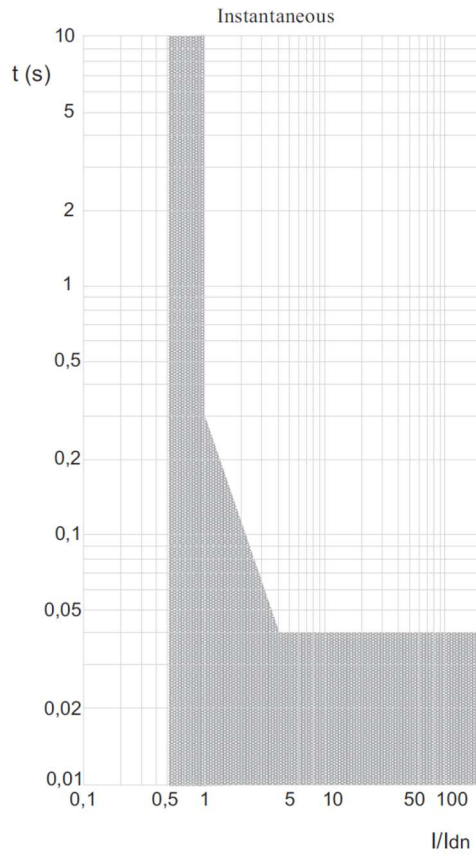

9.4.2 Earth leakage curve, time delay = 0.3 s

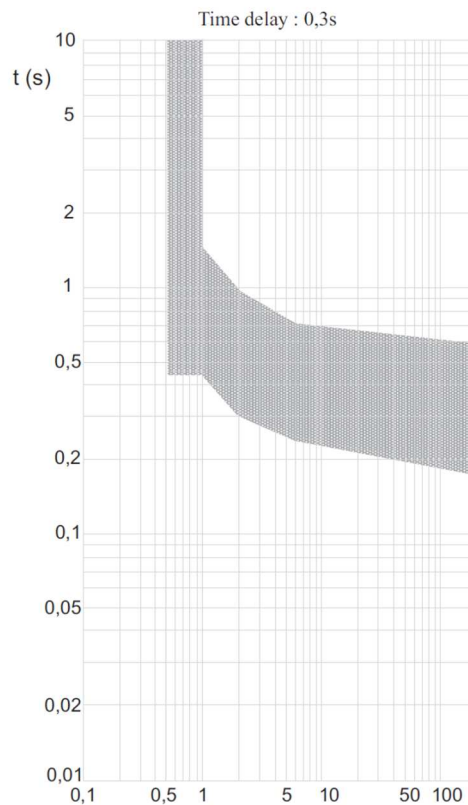

9.4.3 Earth leakage curve, time delay = 1 s

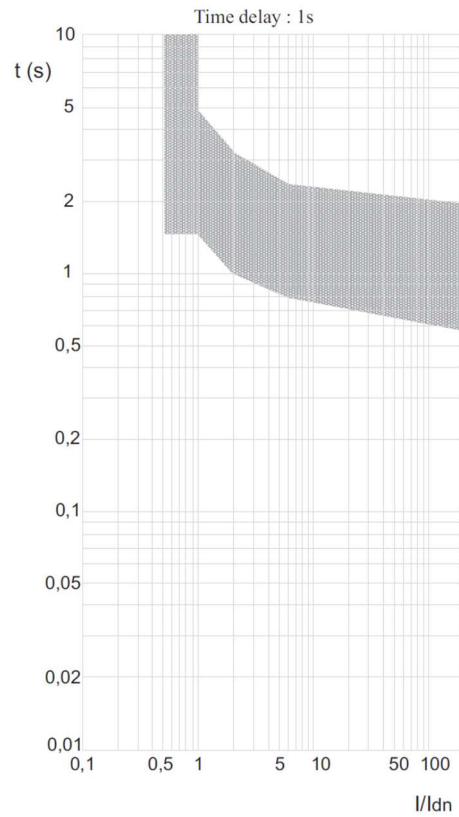

9.4.4 Earth leakage curve, time delay = 3 s

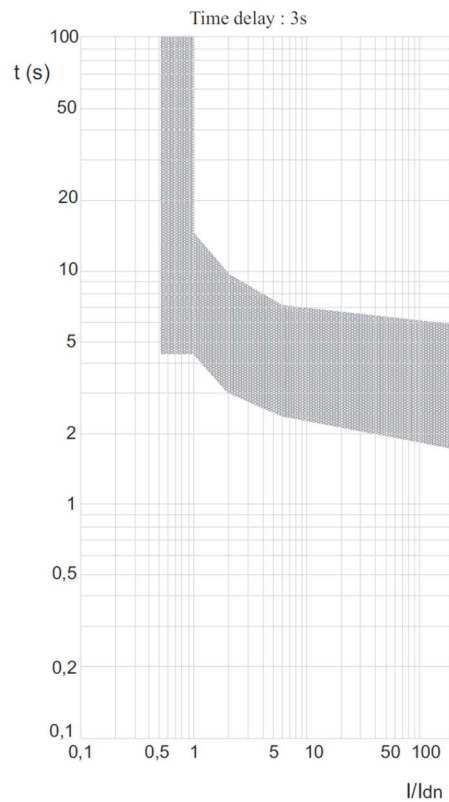

DPX³ 250 Electronic + earth leakage

Reference(s): 420 322/ 325/ 327/ 329/ 352/ 355/ 357/ 359/
 420 382/ 385/ 387/ 389/ 655/ 657/ 658/ 659/
 420 422/ 425/ 427/ 429/ 452/ 455/ 457/ 459/
 420 482/ 485/ 487/ 489/ 685/ 687/ 688/ 689/

A) Derating Temperature and configurations

		Ambient temperature									
		30 °C		40 °C		50 °C		60 °C		70 °C	
Fixed version		I _{max} (A)	I _r / I _n	I _{max} (A)	I _r / I _n	I _{max} (A)	I _r / I _n	I _{max} (A)	I _r / I _n	I _{max} (A)	I _r / I _n
DPX ³ 250 fixed - vertical installation	Cage terminals, flexible cable	250	1	250	1	230	0,92	210	0,84	190	0,76
	Cage terminals, flexible cable + sealable terminal shields	250	1	238	0,95	200	0,8	175	0,7	175	0,7
	Cage terminals, rigid cable	0	0	0	0	0	0	0	0	0	0
	Lugs, flexible cable	0	0	213	0,85	0	0	0	0	150	0,6
	Lugs, rigid cable	0	0	0	0	0	0	0	0	0	0
	Spreaders, flexible cables	250	1	250	1	200	0,8	175	0,7	163	0,65
	Spreaders, rigid cable	0	0	0	0	0	0	0	0	0	0
	Rear flat staggered terminals, flexible cable	250	1	213	0,85	188	0,75	163	0,65	163	0,65
	Rear flat staggered terminals, rigid cable	0	0	0	0	0	0	0	0	0	0
DPX ³ 250 fixed - horizontal installation	Cage terminals, flexible cable	238	0,95	225	0,9	200	0,8	175	0,7	163	0,65
	Cage terminals, flexible cable + sealable terminal shields	238	0,95	225	0,9	200	0,8	175	0,7	163	0,65
	Cage terminals, rigid cable	0	0	0	0	0	0	0	0	0	0
	Lugs, flexible cable	0	0	0	0	0	0	0	0	0	0
	Lugs, rigid cable	0	0	0	0	0	0	0	0	0	0
	Spreaders, flexible cables	250	1	213	0,85	200	0,8	175	0,7	163	0,65
	Spreaders, rigid cable	0	0	0	0	0	0	0	0	0	0
	Rear flat staggered terminals, flexible cable	238	0,95	200	0,8	188	0,75	163	0,65	150	0,6
	Rear flat staggered terminals, rigid cable	0	0	0	0	0	0	0	0	0	0

Data indicated in this document refers exclusively to test conditions according to product standards, unless otherwise indicated in the documentation.

For the different conditions of use of the product, inside electrical equipment or in any case inserted in the installation context, refer to the regulatory requirements of the equipment, local regulations and design specifications of the system