

## Arteor™ Mirror plates for franco-belgian and german standard

Cat. No(s): 5 750 23/24/33/34/43/44/53/54/63/64  
5 755 13/14/23/24  
5 756 03/04  
5 762 25/26/35/36/45/46/55/56/65/66/75/76/85/86  
5 765 53/54/63/64

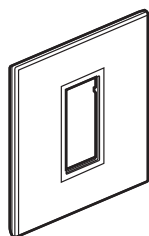

5 762 25/26  
5 765 53/54

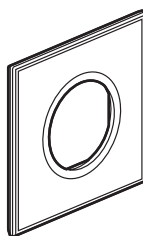

5 756 03/04  
5 762 35/36

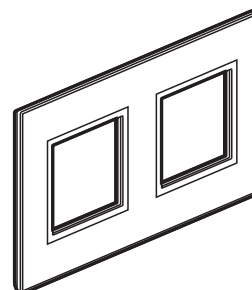











5 750 03/04  
5 762 35/36

### 1. USE

Plates for covering mechanisms

### 2. RANGE

	Designation	Finishes				No. of modules	Fixing method	Weight (g)
		White	Black	Red	Taupe			
	1 module plate square	5 765 53	5 765 54	5 762 26	5 762 25	1	with clips	27.5
	2 modules plates square	5 765 64	5 765 63	5 762 46	5 762 45	2	with clips	25.3
	2 modules plate round	5 756 04	5 756 03	5 762 36	5 762 35	2	with clips	36
	4 modules plate square	5 750 34	5 750 33	5 762 76	5 762 75	4	with clips	39.3
	2 x 2 modules plate square	5 750 24	5 750 23	5 762 66	5 762 65	2 x 2	with clips	38.5
	2 x 2 modules plate round	5 755 14	5 755 13	5 762 56	5 762 55	2 x 2	with clips	59.9
	6 modules plate square	5 750 44	5 750 43	5 762 86	5 762 85	6	with clips	59.5
	3 x 2 modules plate square	5 750 54	5 750 53			3 x 2	with clips	58.3
	3 x 2 modules plate round	5 755 24	5 755 23			3 x 2	with clips	90
	2 x 6 modules plate square horizontal mounting	5 750 64	5 750 63			2 x 6	with clips	114.9

## 3. OVERALL DIMENSIONS

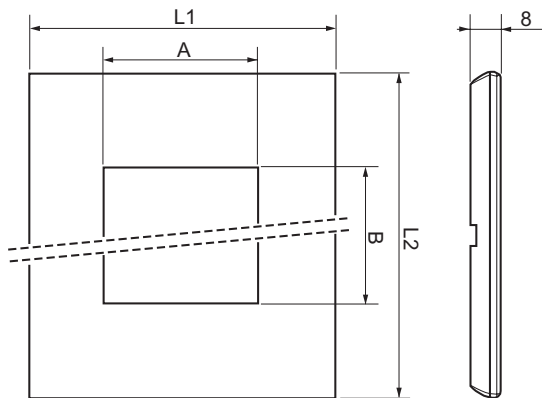

Cat. No.	L1	L2	A	B
5 750 23/24	157	92	2 x 45.4	2 x 45.4
5 750 33/34			90.6	45.4
5 750 43/44			135.8	
5 750 53/54	238	179	3 x 45.4	3 x 45.4
5 750 63/64			2 x 135.8	2 x 45.4
5 755 13/14	92	157	2 x Ø 45.4	
5 755 23/24	238	92	3 x Ø 45.4	
5 756 03/04	92		Ø 45.4	
5 762 25/26			22.8	45.4
5 762 35/36		Ø 45.4		
5 762 45/46	157	92	45.4	45.4
5 762 55/56			2 x Ø 45.4	
5 762 65/66			157	92
5 762 75/76	90.6	45.4		
5 762 85/86	238		135.8	
5 765 53/54	238		92	22.8
5 765 63/64		45.4		

## 4. MOUNTING

The plates clip on in notches onto screw-type or claw-type mounting supports (notches are used for thickness compensation. E.g: wall paper). Easy to remove with a screwdriver.

No flatness defect of more than 1.5 mm in a periphery of 10 cm around the installed flush box.

Protection film must be removed only once site work is fully completed.

## 5. TECHNICAL CHARACTERISTICS

## 5.1 Mechanical characteristics

Impact tests : IK 04

## 5.2 Material characteristics

Front plate: polycarbonate

Under plate: polycarbonate

Surround: chromed zamac

## 5.3 Climatic characteristics

Storage temperatures: - 10° C to + 70° C

Operating temperatures: - 5° C to + 50° C

## 6. CLEANING

Surface cleaning with a cloth.

Do not use: acetone, tar remover, trichloroethylene.

## 6.1 Resistance to cleaning agents

Hexane (EN 60669-1), methylated spirits, soapy water, glass cleaning substance.

## 6.2 Resistance to hospital-type cleaning agents

Resistance to the following agents: Anios, Surfanios, Bactily sine, Hydrogen peroxyde (30%).

## 7. SPECIAL USE

Arteor plates must not be painted.