



6946 41



Pro & Consumer Service
GR 20170 F. 01022 Limnos Gales 1
www.legrandelctri.com

15 000 1 000 000
ELEKTRONIK

**Multioutlet extension
SAFE CONTROL**
Base múltiple SAFE CONTROL
Πολύπριζο SAFE CONTROL
SAFE CONTROL
produžni kabel

**Razdelilni podaljšek –
VARNA KONTROLA**
Elosztósor SAFE CONTROL

**SAFE
CONTROL
SYSTEM**



- ⓑ Protect against electrical overload and risk of overheating
- ⓔ Protege contra las sobrecargas eléctricas y los riesgos de calentamiento
- ⓑ Προστατεύει από ηλεκτρικές υπερπρέρσεις και από υπερθέρμανση
- ⓓ Štiti od strujnog preopterećenja i rizika pregrijavanja
- ⓑ Zadržuje predpreobremetljivo in overspanjem
- ⓓ Hatásos védelem a túlláram és túlterheltség ellen.

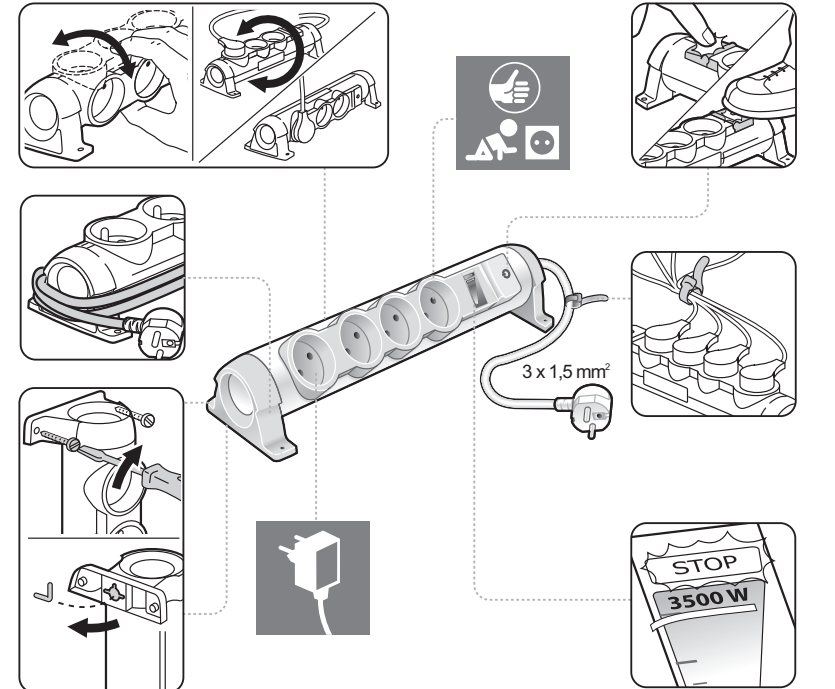
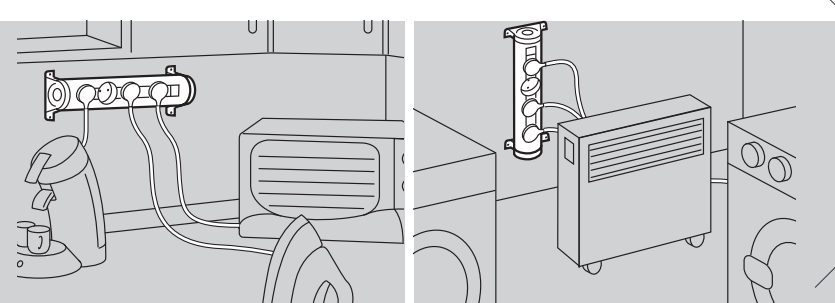
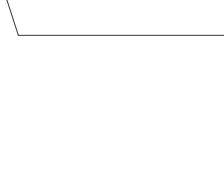
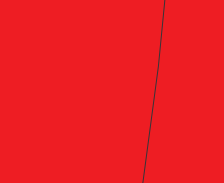
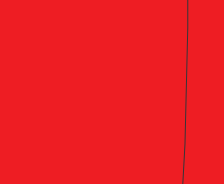
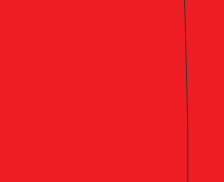
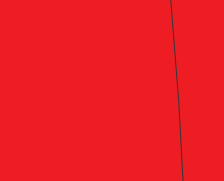
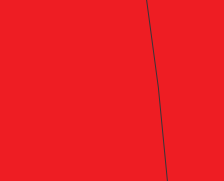
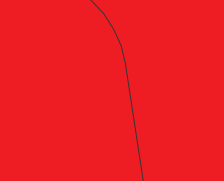
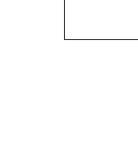
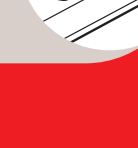

ⓑ There is an electrical overload and risks of overheating when the power requested by the connected devices exceed the maximum power that can be accepted by the multioutlet extension. The Safe control system indicates the level of power consumed and in case of overload, the thermal protection shuts down the power to guarantee your security.
⚠. Strictly respect the installations and uses conditions

ⓓ Do preopterećenja i pregrijavanja dolazi kada je snaga uređaja koji su priključeni na produžni kabel veća od snage predviđene za produžni kabel. Safe Control sustav pokazuje nivo preopterećenja, termička zaštita će isključiti napajanje i garantirati vam potpunu sigurnost.
⚠. Striktno poštujujte pravila upotrebe i instalacije

ⓔ Existe sobrecarga eléctrica y riesgo de calentamiento cuando la potencia solicitada por los aparatos conectados sobrepasa la potencia admisible por la base múltiple. El sistema Safe Control indica el nivel de potencia consumida y en caso de sobrecarga, la protección térmica se dispara y corta la alimentación para garantizar su seguridad.
⚠. Respete estrictamente las condiciones de instalación y uso

ⓓ Preobremetev in možnost pregrevanja lahko nastopi v primeru prikljupa prevelikega bremena na razdelilni podaljšek. Sistem varne kontrole prikazuje nivo porabe in v primeru preobremetevne termična zaščita izklopi tokokrog ter vas tako zaščiti.
⚠. Natančno upoštevajte navodila instalacije in načina uporabe

ⓑ Υπάρχει υπερφόρτωση και κίνδυνος υπερθέρμανσης όταν η ζητούμενη ισχύς από τις συνδεδεμένες συσκευές ξεπερνά τη μέγιστη ισχύ που αντέχει το πολύπριζο. Το σύστημα SAFE CONTROL δείχνει το μέγεθος της κατανάλωσης και σε περίπτωση υπερφόρτωσης η θερμική προστασία διακόπτει την παροχή για την ασφαλέα της συσκευής.
⚠. Τηρείστε με προσοχή τις οδηγίες εγκατάστασης

ⓓ Ha az elosztóba csatlakoztatott készülékek a maximális elektromos terhelési értéket meghaladják, elektromos túlterheltség, túlmelegedés kaphat fel. A SAFE CONTROL rendszer jelzi a teljesítmény szintet, így túlterheltség esetén a hőszabályozó központhoz az áramellátás megszünik, ezzel biztosítva Ön és környezeté biztonságát.
⚠. Az üzembekelés és használati feltételeket vegye figyelembe!

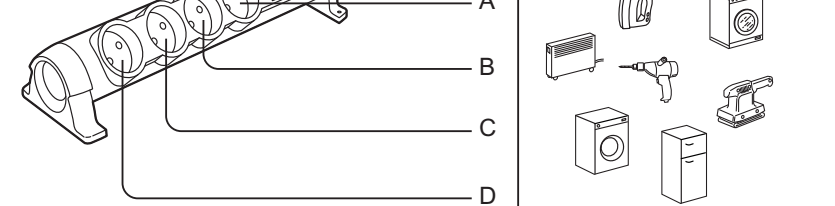

■ A + B + ... < 3500 W → OK

■ A + B + C + D > 3500 W → STOP 3500 W

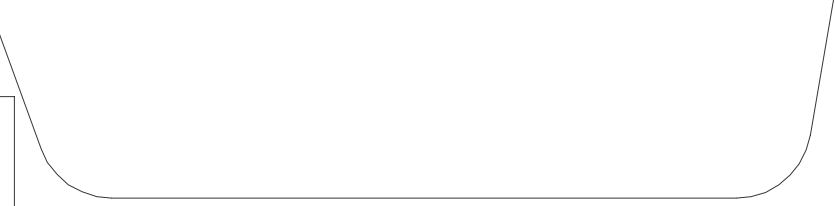
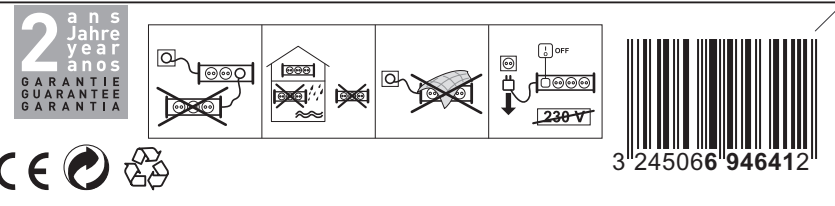
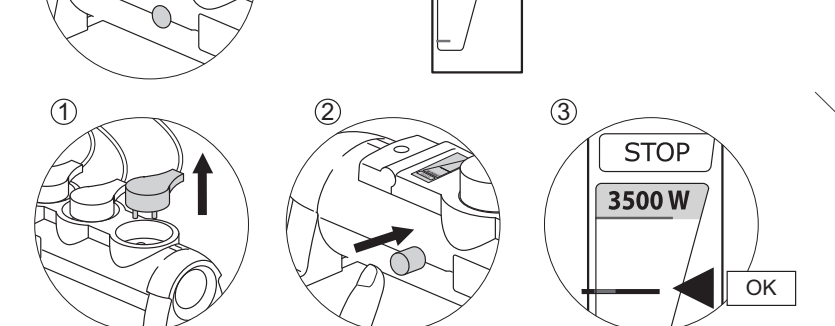

Multioutlet extension
SAFE CONTROL
Base múltiple SAFE CONTROL
Πολύπριζο SAFE CONTROL

SAFE CONTROL
produžni kabel
Razdelilni podaljšek –
VARNA KONTROLA
Elosztósor SAFE CONTROL

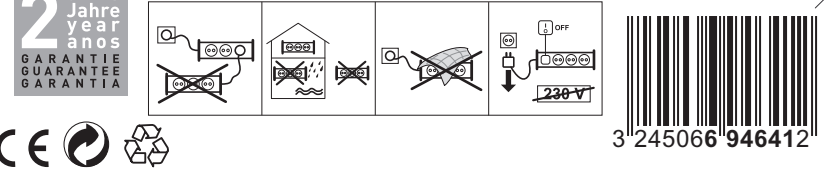
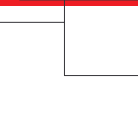

3 245066 946412