

sarlam

KALANK

NT 37 016/02

T 1 (Ø 198 mm)

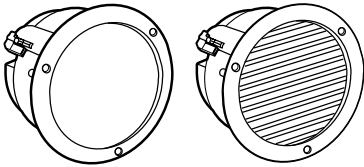

T 2 (Ø 270 mm)

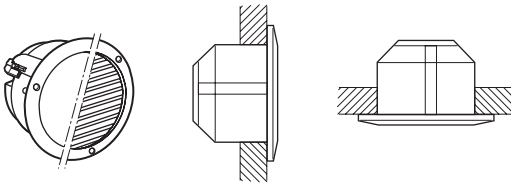
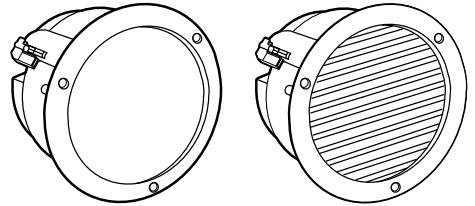

T1 Max.



10 W

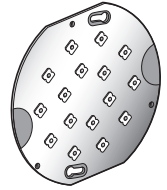

1 W 16 Leds

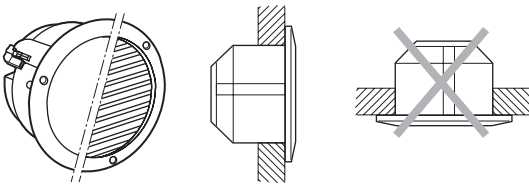

T2 Max.

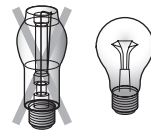

E27 - 60 W

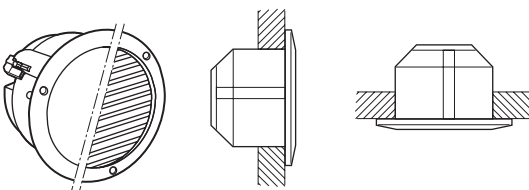

T2 Max.

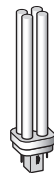

18W

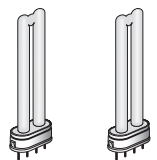

2 x 9W

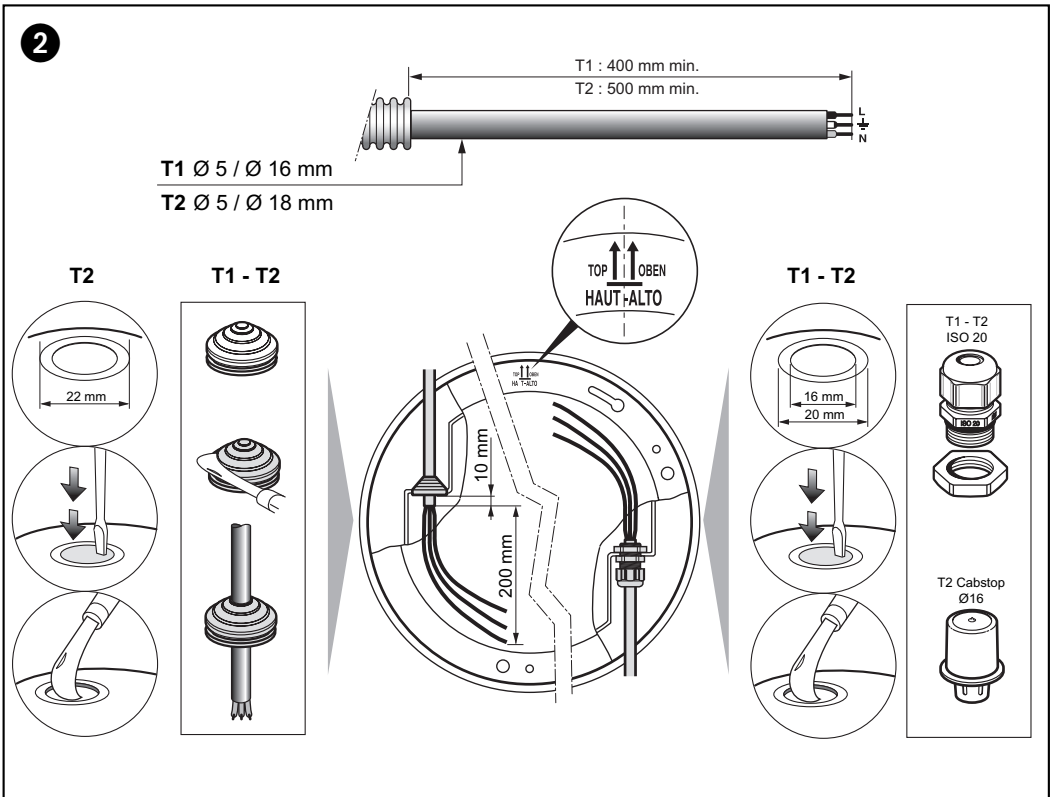
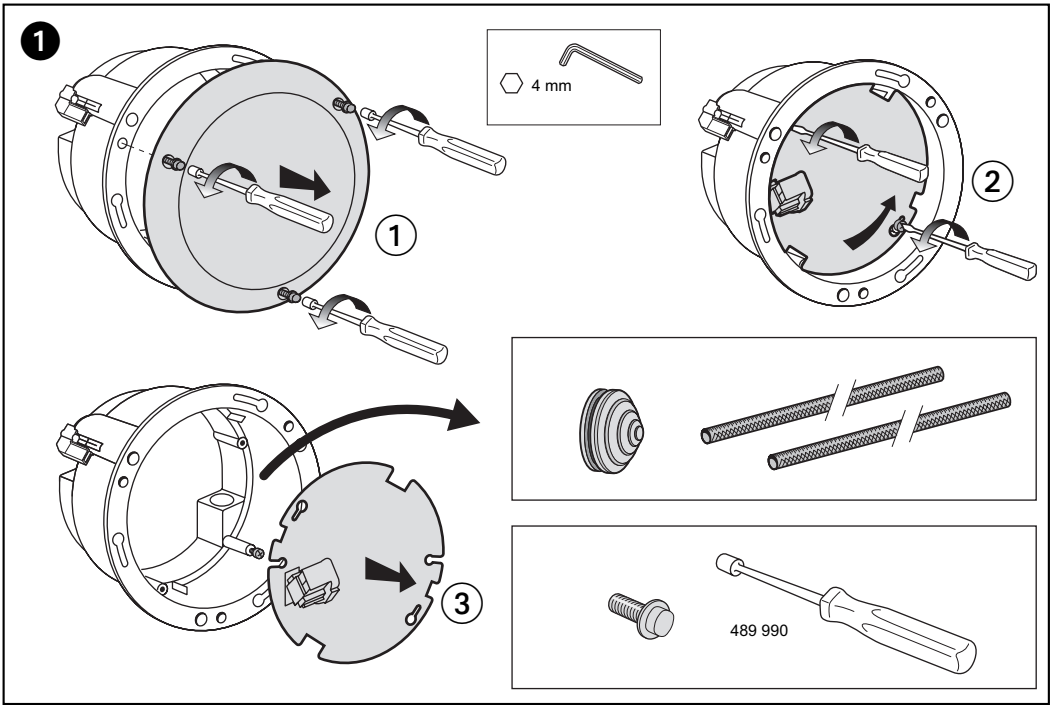

3

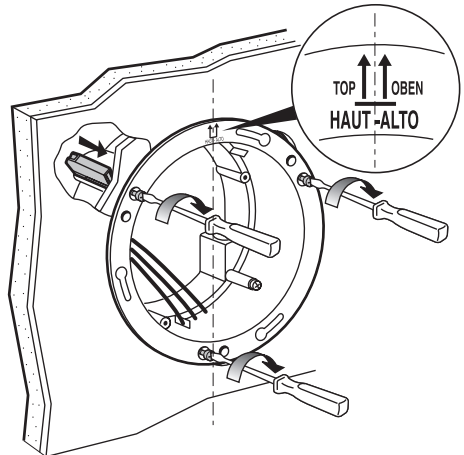
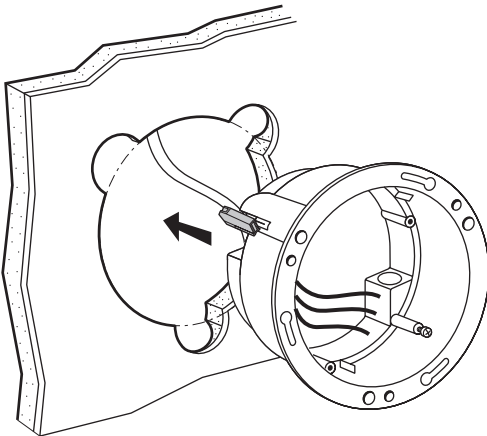
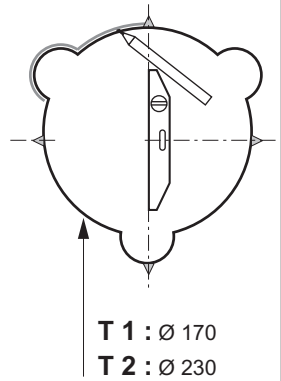
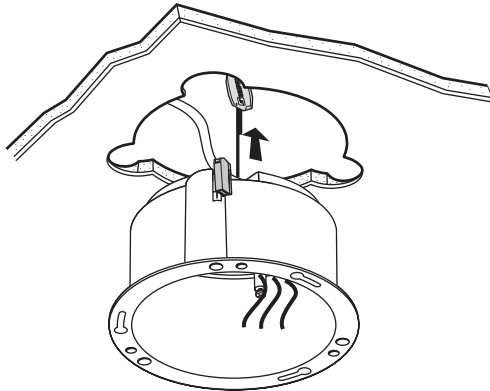
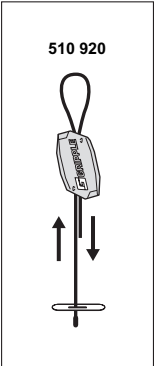
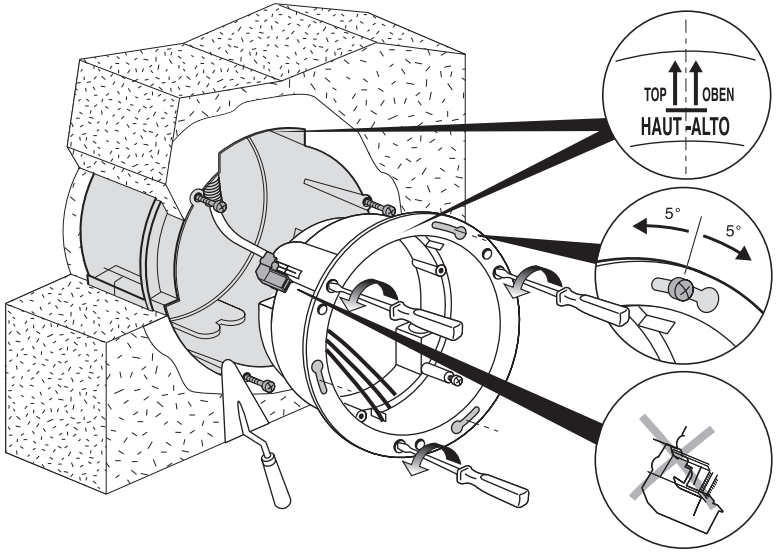
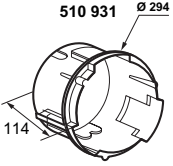
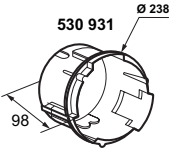

T 1 - T 2

Cl. I

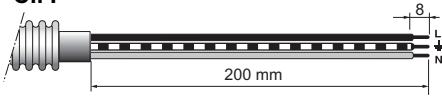

T 2

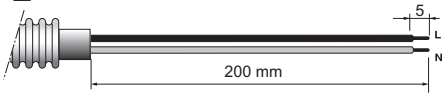

L
N

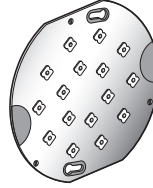
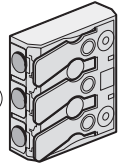

L1
N

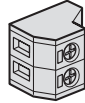

4

