



 **Safety notes**

This product should be installed in line with installation rules, preferably by a qualified electrician. Incorrect installation and use can lead to risk of electric shock or fire. Before carrying out the installation read the instructions and take account of the product's specific mounting location. Do not open up, dismantle, alter or modify the device except where specifically required to do so by the instructions. All Legrand products must be opened and repaired exclusively by personnel trained and approved by Legrand. Any unauthorised opening or repair completely cancels all liabilities and the rights to replacement and guarantees. Use only Legrand brand accessories.

The device contains a LiMnO₂ primary cell. When the product reaches the end of its life, this cell must be correctly removed and disposed of in accordance with national legislation and the requirements of environmental protection.

Technical data

Supply voltage:	230V 50/60Hz	
Power consumption:	ca. 1,3 W	
Relay outputs:	1 Γ 16A 250V~ $\mu \cos \varphi = 1$	
Accuracy:	~ 0,1 s /day	
Wire cross-sections:	single-strand 1,5...4 mm ²	multi-strand 1,5...2,5 mm ²
Programs:	3 program types x 28 programs	
Shortest switching step	1 minute	
Local coordinates:	Resolution 1°/ 1' in EXPERT-Mode	
Time signal DCF 77	Antenna 4 127 06	
	50 m	
Receipt of GPS signal	Antenna 4 127 07	
	50 m	
Battery reserve:	5 years	
Storage temperature:	- 20°C to +60°C	
Operating temperature:	-20°C to +55°C	



IP:

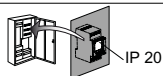

General information

 It should be noted that this device may only be used with the antenna type reference 412706 or 412707 otherwise there will be danger of electric shock.

- The device should not be used on isolated low voltage.

After applying the supply voltage, the time switch starts automatically with the last selected function. The relay position is set by the current program.

• **Battery backup**

- Backlighting not active
- Data key READ/WRITE only via the menu



Select menu, back to main menu,
Hold down > 1s = operating display



Confirm selection or load parameters



Select menu options or set parameter

 Dangerous electrical voltage in the antennas (230 V to ground potential). Before opening the housing the device must absolutely be disconnected from mains.

INFO!
GPS/DCF
WRONG!

Check polarity

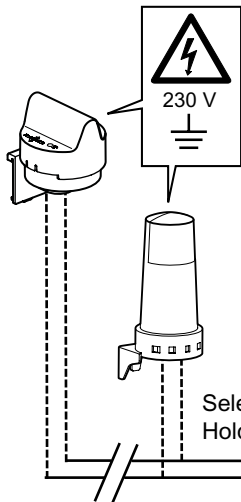

max. 50 m

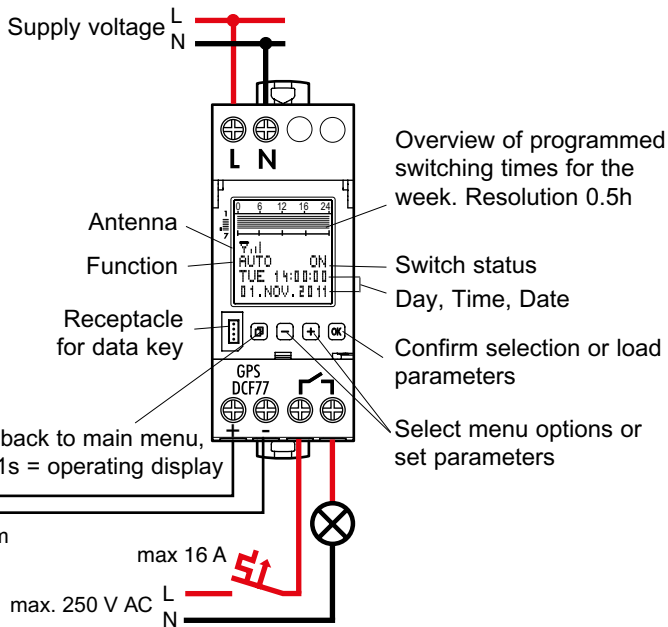





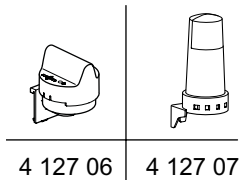

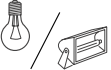

Antenna DCF77, reference **4 127 06**
 or antenna GPS, reference **4 127 07**

} must be ordered separately

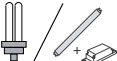

Operating principle: Typ 1.B. S. T.
 IEC/EN 60730-1, IEC/EN 60730-2-7
 Operation in a normal environment
 Montage: in distribution panel,
 Degree of contamination: 2
 Switch output, potential-free
 Rated impulse voltage: 4 kV

			
4000 W	2000 VA	600 W 70µF	2000 W
			
2000 W	2000 W	2000 W	1000 W
			 LED
			1000 W

Overview

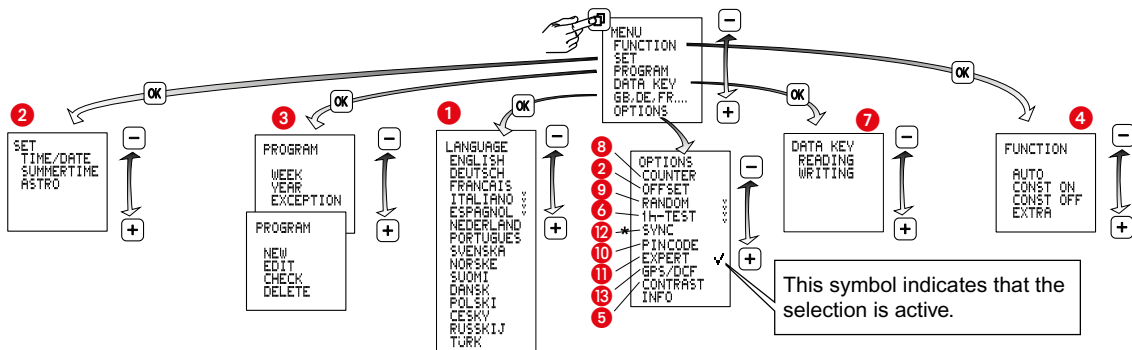

* Only available in EXPERT mode.

1 Set language

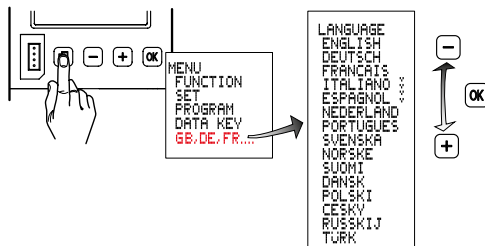

2 Set

A Set time/date

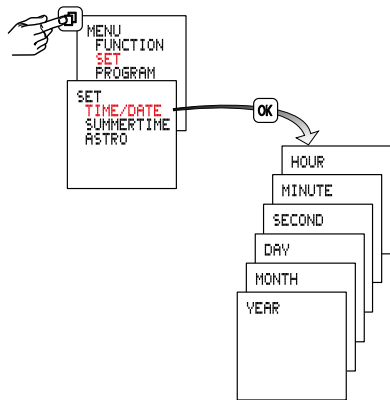

B Summertime

Summertime: ± 1 hour

Europe: Factory set

SPECIAL: The switchover to/from summertime can be freely programmed by entering a start date and end date and is then executed each year on the same day of the week, e.g. Sunday

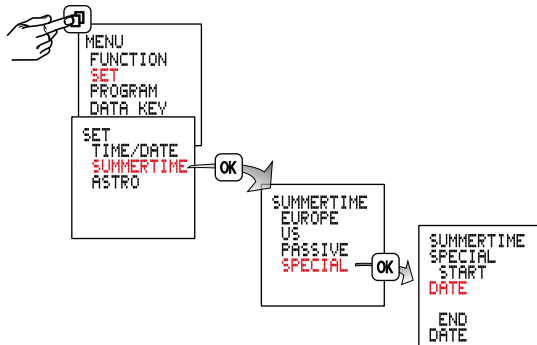

C Astro

Select country.
Select the city
closest to the
planned location
for use.

You can adjust the coordi-
nates more precisely with
LONGITUDE and
LATITUDE.

Use the enclosed **time-zone map** to set
the correct time zone.
From this map, determine the difference
between local time and UTC (**U**niversal
Time **C**oordinated) and set this value.

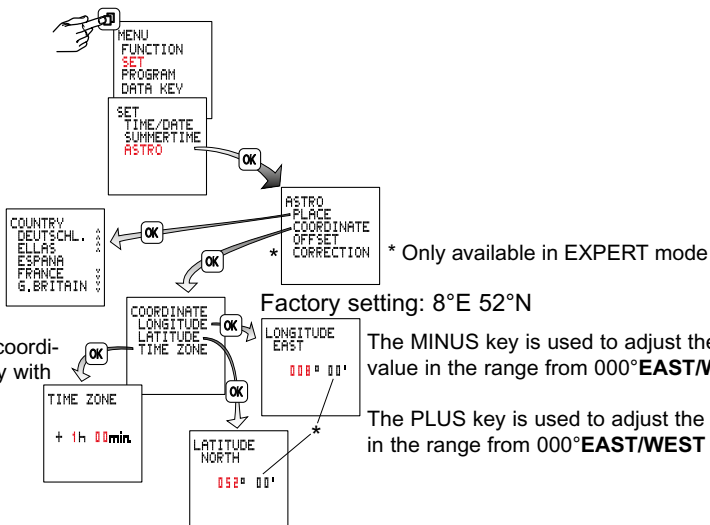

The MINUS key is used to adjust the westward longitude
value in the range from 000°**EAST/WEST** to 180°**WEST**.

The PLUS key is used to adjust the eastward longitude value
in the range from 000°**EAST/WEST** to 180°**EAST**.

The PLUS key is used to adjust the northward latitude value in
the range from
00°**NORTH/SOUTH** to 90°**NORTH**.

The MINUS key is used to adjust the southward latitude value in
the range from 00°**NORTH/SOUTH** to 90°**SOUTH**.

D Offset

1



MENU
FUNCTION
SET
PROGRAM
DATA KEY
GB/DE/FR...
OPTIONS

-

+

OK

OPTIONS
COUNTER
OFFSET
RANDOM
1H-TEST
SYNC

-

+

OK

OFFSET
TIME ✓
ANGLE

-

+

OK

2 Offset

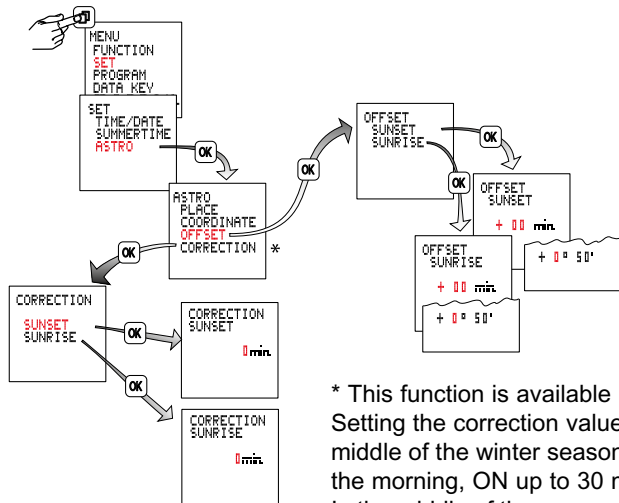

* This function is available in Expert mode.

Setting the correction value (1...30 min.) extends the daily ON period in the middle of the winter season by up to 60 minutes (OFF up to 30 min. later in the morning, ON up to 30 min. earlier in the evening).

In the middle of the summer season, the correction setting reduces the daily ON period by up to 60 minutes (OFF up to 30 min. earlier in the morning, ON up to 30 min. later in the evening).

2 Offset

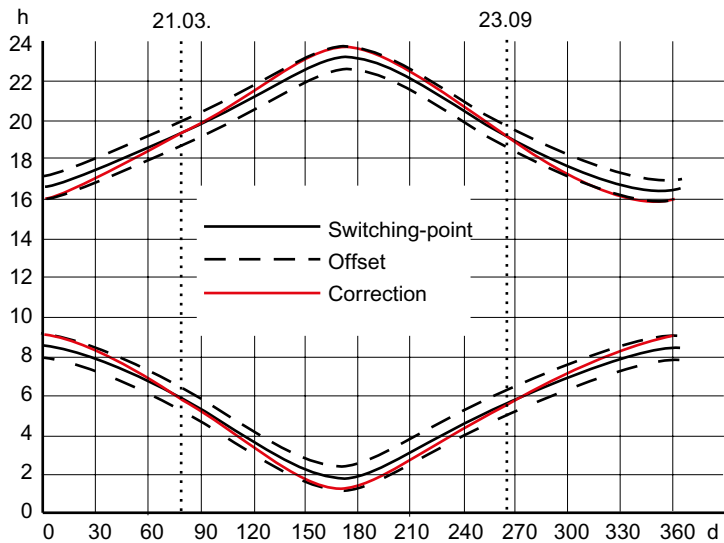

② Offset

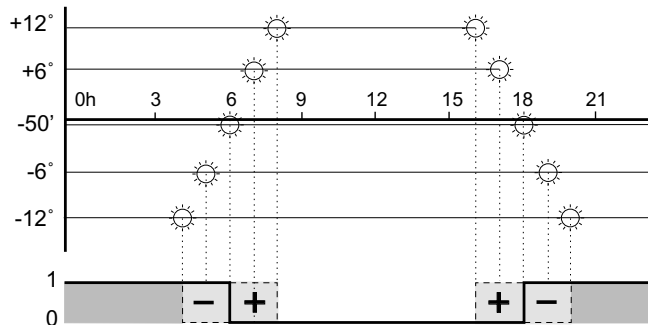

If the offset setting is in degrees the time switch switches on and off at times of equal brightness, despite the differences in twilight time lengths over the course of the year. Sunrise and sunset correspond to -50' for the centre of the sun (the edge of the sun is visible on the horizon).

3A PROGRAM / WEEK

This menu item is provided for the simple input of programs which are to be repeated weekly (such as switching of lights and boilers).

A weekly program consists of an ON time, an OFF time and the associated ON and OFF days.

- **MON TO SUN:** the days of the week are already assigned and you only need to set the ON and OFF times. This is used where the same program is to be executed on every day of the week.
- **INDIVIDUAL:** you can assign the ON and OFF times to any desired days. This is used where the same program is to be executed only on certain days of the week or different programs are to be executed on the various days.

OR function

The programs defined for each channel are ORed together. In other words, the output will be active if this is defined in any of the programs.

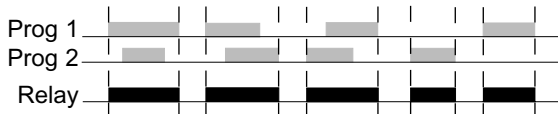

3A PROGRAM / WEEK

Sample WEEK program

The timer is to switch on at sunset on each day of the week and switch off at sunrise.

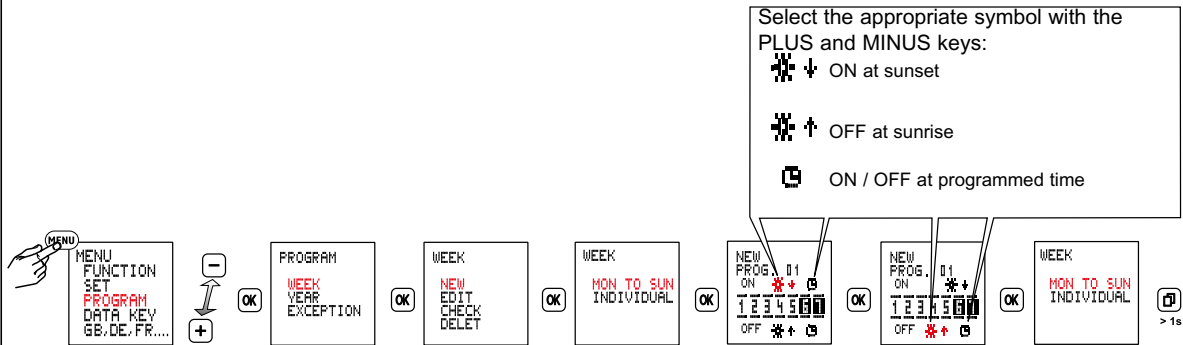

3B PROGRAM / YEAR

This menu item permits the input of (additional) annual programs which are to be executed only during a specified period. These programs and the weekly programs of the same channel are ORed together as described above.

The period during which a program is to be executed is defined by entering a start date and an end date.

- The option EVERY YEAR should be selected if the additional program is to be executed during the same period of each year (e.g. Christmas, national holidays, birthdays, etc.).
- The option ONCE should be selected if the additional program is to be executed only during a single period (e.g. vacation period), but the start and end dates of this period are different in each year.
- The option MOVABLE should be selected if additional switching times are to be performed on movable public holidays/special days. (e.g. Easter, Whitsun, etc.). Entry is always for the current year. In the years that follow, the switch always takes place on the selected movable public holidays/special days.

Default is Easter Sunday of the current year. → **3D**

3B**Sample YEAR program**

Activate each year on at 09:00 hours on 01.11. and deactivate at 23:00 hours.

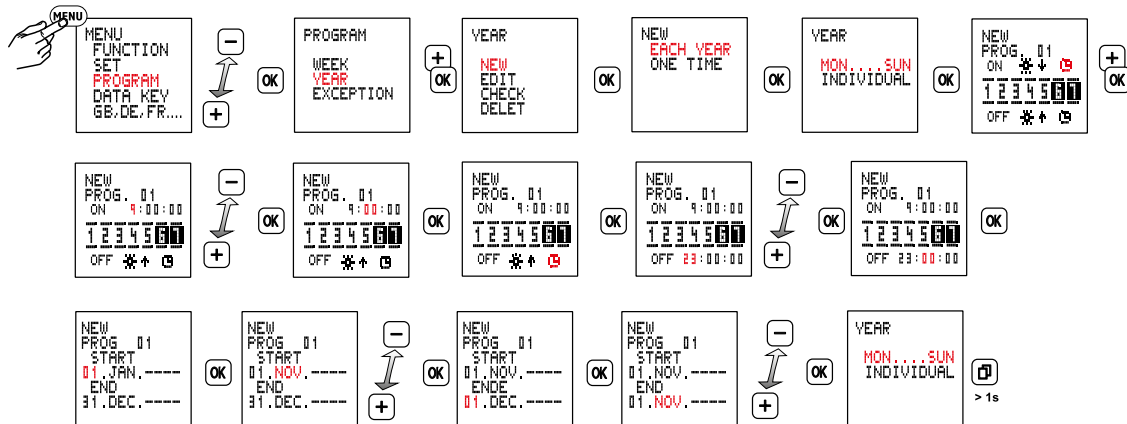

3C PROGRAM / EXCEPTION

The weekly and annual programs defined are not executed as long as an extra program is active. However, other exception programs will be executed while an exception program is active.

The various exception programs are ORed together as described above. (see OR function 3a)

- The option EVERY YEAR should be selected if the exception program is to be activated for the same period in each year (e.g. Christmas, national holidays, birthdays, etc.).
- The option ONCE should be selected if the exception program is to be activated only during a single period (e.g. vacation period), but the start and end dates of this period are different in each year.

The option MOVABLE should be selected if additional switching times are to be performed on movable public holidays/special days. (e.g. Easter, Whitsun, etc.). Entry is always for the current year. In the years that follow, the switch always takes place on the selected movable public holidays/special days.

Default is Easter Sunday of the current year. → **3D**

- Option MON TO SUN: the exception program is active from 00:00 hours on the start date to 24:00 hours on the end date. During this period, the time switch switches only as defined in the exception program.
- Option INDIVIDUAL: the exception program is active from 00:00 hours on the start date to 24:00 hours on the end date. During this period, the switching is only as only as defined in the exception program.
- Option PROG ON: the exception program is active from the ON time on the start date to OFF time on the end date. During this period, the output is permanently on.
- Option PROG OFF: the exception program is active from the ON time on the start date to OFF time on the end date. During this period, the output is permanently off.

3C Sample EXCEPTION programs

- ① The output is to be switched off each year for the entire period 01.08. to 31.08.

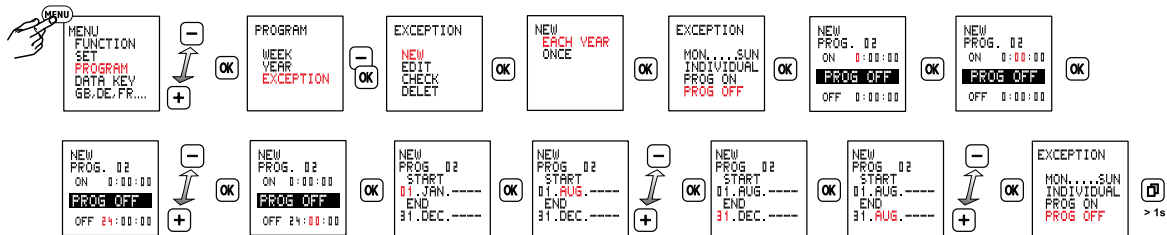

3C Sample EXCEPTION programs

② Each year from 25.12. to 26.12., the output is to be switched on at 6:00 hours, switched off at sunrise, switched on at sunset and switched off at 23:00 hours. For this, two programs are needed:

Program 1: ON at 6:00 and OFF at sunrise

Program 2: ON at sunset and OFF at 23:00

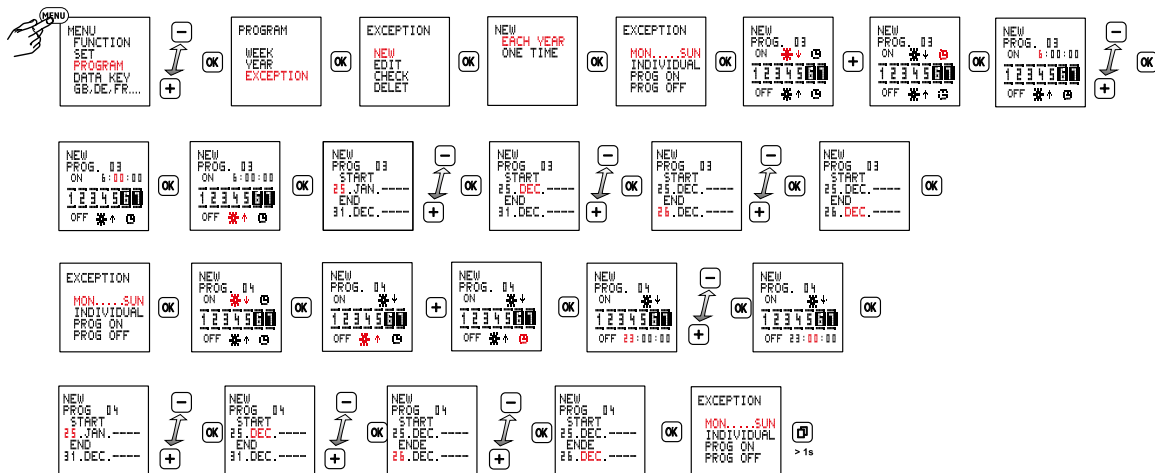

3D Movable public holidays/special days

The clock calculates movable public holidays which are dependent on the liturgical* Easter date according to the rule of Gauß and therefore takes into account the annual shift of the Easter date. The movable public holidays align with the shift; they are always realised with a certain number of differential days to Easter.

* Note: In some years, there is a difference between the liturgical and orthodox Easter date.

Name of public holiday	Time to Easter Sunday
Maundy Thursday	- 3 days
Good Friday	- 2 days
Easter Sunday	0
Easter Monday	+1 day
Ascension Day	+ 39 days
Whit Sunday	+ 49 days
Whit Monday	+ 50 days
Corpus Christi	+ 60 days

3E

PROGRAM Edit/Check/Delete

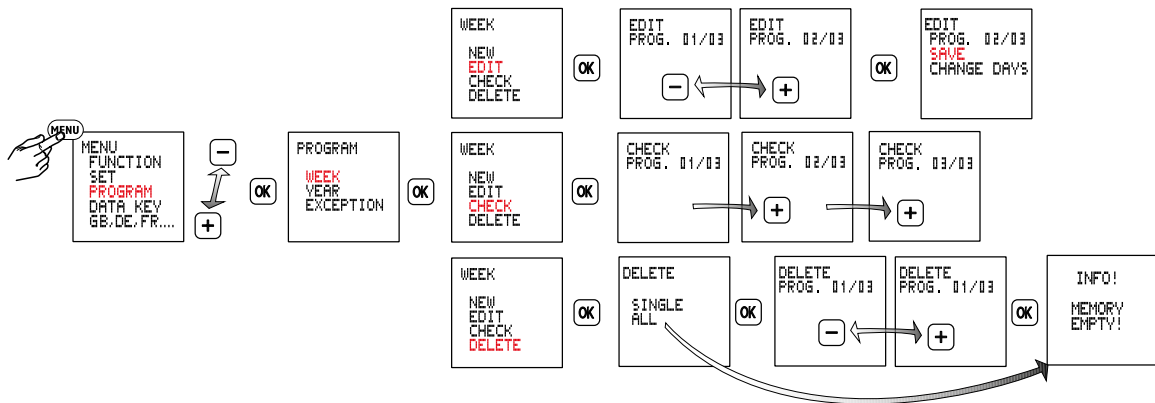

4 Modes

- **Auto** - Automatic operation
- **Constant ON**
- **Constant OFF**
- **Extra**

The switch status imposed by the program is inverted (manual override). With the next effective switch command, the time switch resumes control of on/off switching.

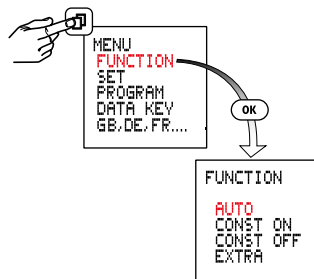

5 Contrast adjustment

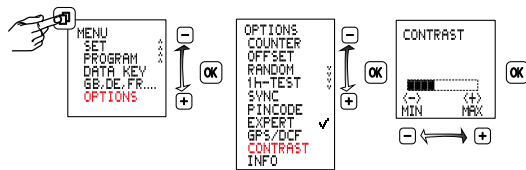

6 1 h-Test

When this function is activated, the output is switched on for one hour.

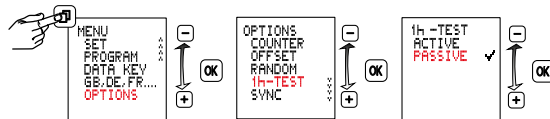

After one hour, the time switch returns automatically to the programmed mode.

7 Data key

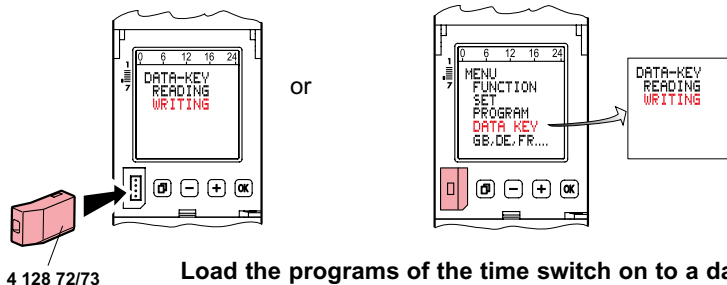

4 128 72/73

Load the programs of the time switch on to a data key (WRITE KEY)

Warning! all programs stored on the data key will be overwritten.

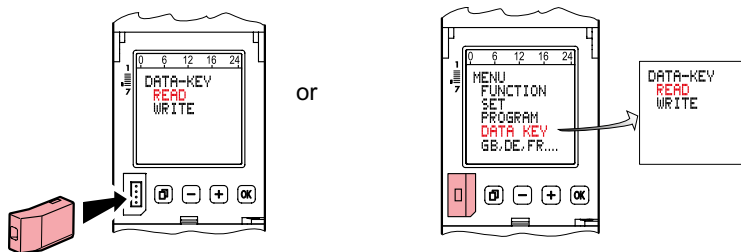

Load the programs from the data key to the time switch (READ KEY)

Warning! all programs programmed in the time switch will be overwritten.

8 Hour counter

Displays the total relay ON time, (0 to 65535 h) and the date of the last reset.

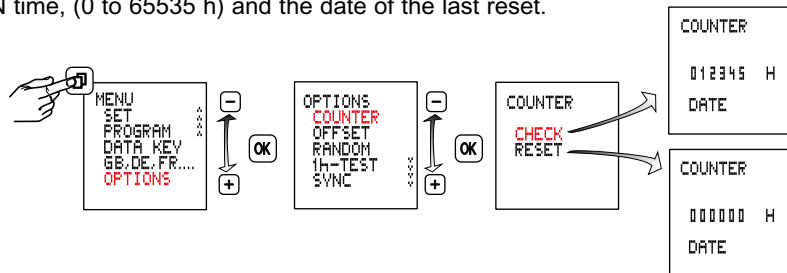

9 Random function

Function to simulate presence.

Function active: the programmed switching cycles are shifted at random within the range of ± 15 minutes.

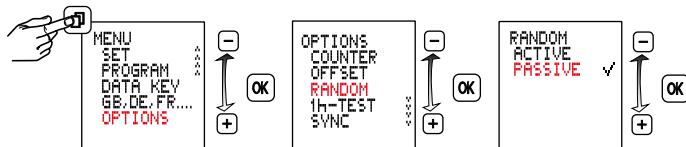

10 Pincode

PIN CODE active: The menus of the time switch will not be accessible unless the PIN CODE has been entered. When the pin code is active, access to the button and key functions is disabled 1 minute after the last button press.

PIN free access can be re-enabled by selecting PASSIVE or by resetting the device.

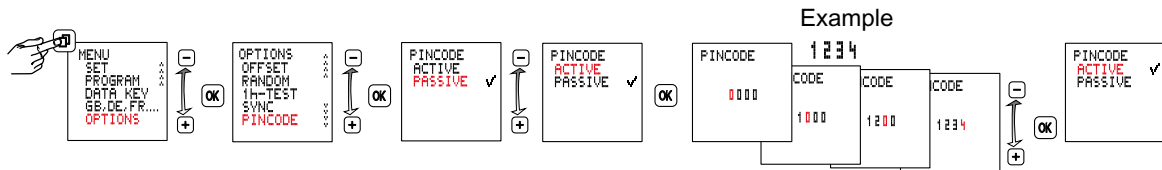

11 Expert mode

Some additional functions are available in Expert mode:

- Power grid synchronisation to improve the accuracy
- Summer / winter seasonal correction
- Local coordinates exact to the minute

Note: Upon switching from ACTIVE to PASSIVE the additional menu items are hidden again and all the Expert mode settings are cancelled. After re-activating, Expert mode will operate again with the basic settings.

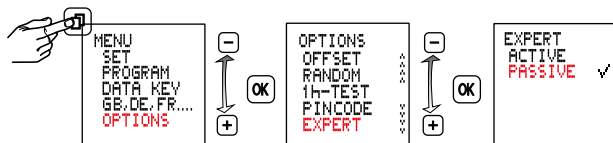

12 Activating and deactivating grid synchronisation

Only available in EXPERT mode.

The default setting is PASSIVE. In order to improve the long-term accuracy, it is advisable to activate synchronisation if the time switch is supplied from a on 50/60 Hz grid with frequency adjustment.

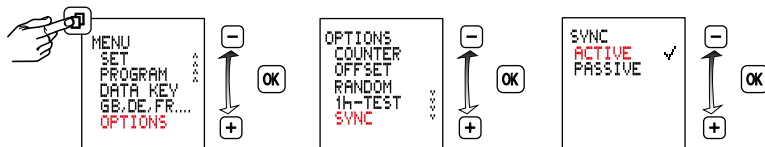

13 DCF77 / GPS

An external antenna will receive the time signal DCF 77 (DCF antenna, ref. 4 127 06) or the time and the local coordinates (GPS antenna, ref. 4 127 07). **Only one antenna is allowed to connect.**

A DCF77

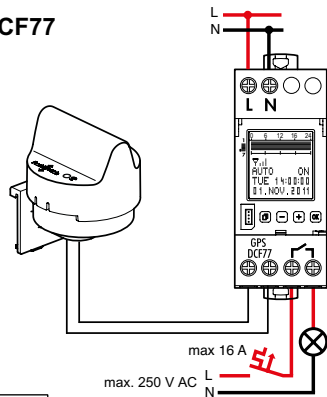

Synchronising on DCF77 signal



Receiving the DCF77 signal



It's the actual time.







INFO!

GPS/DCF
WRONG!

Check polarity

During normal operation, the DCF77 signal is actively decoded every 6 hour for 30 minutes.

Status of synchronisation	
	Actual time is synchronous to DCF77
	the last synchronisation was not possible
	the last two synchronisations were not possible
	Synchronisation is not possible, the next automatic update takes place in 6 hours

The synchronisation starts when either

- an antenna is connected,
- the power supply is switched on,
- Reset is activated
- or the GPS/DCF RESTART menu option is selected.

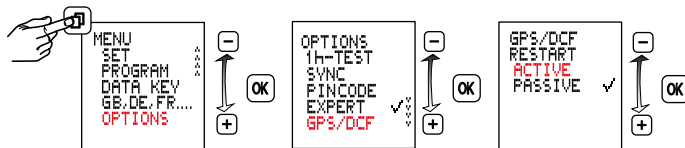

B GPS

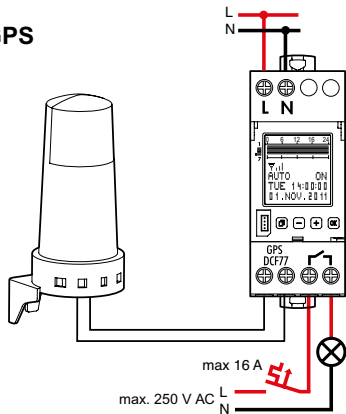

INFO!
GPS/DCF
WRONG!

Check polarity

Synchronising on GPS signal







Receiving the GPS signal



It's the actual time.



During normal operation the GPS-signal is actively decoded every 6 hours for 30 minutes. The time zone is not synchronised. A manual adjustment is necessary. By activating the expert mode the resolution of the coordinates can be increased from degree to minute

Status of synchronisation	
	The time and local coordinates are synchronous to GPS
	the last synchronisation was not possible
	the last two synchronisations were not possible
	Synchronisation is not possible

The synchronisation starts when either

- an antenna is connected,
- the power supply is switched on,
- Reset is activated
- or the GPS/DCF RESTART menu option is selected.

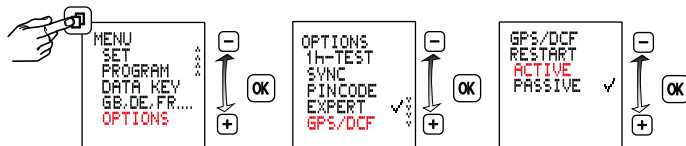

Reset

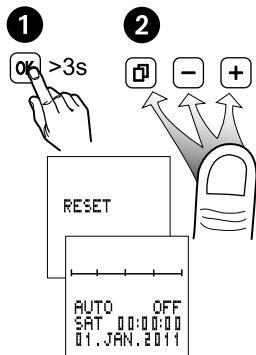

Warning!

The memory will be cleared, and all set data will be lost.

Hold down **OK** for more than 3 seconds and at the same time press and release **Home** **-** **+**.

without Antenna

The language, time, date, summertime/wintertime, local coordinates and switching times will have to be reentered.

with DCF77 Antenna

The language, local coordinates and switching times will have to be reentered.

with GPS Antenna

The language and switching times will have to be reentered.

Warning: Elektrical shock - Disconnect all power from the device before dismantling the module and replacing the battery.

Always use a Li cell type battery (LiMnO₂) CR2477, 3V high temperature type min +85 °C

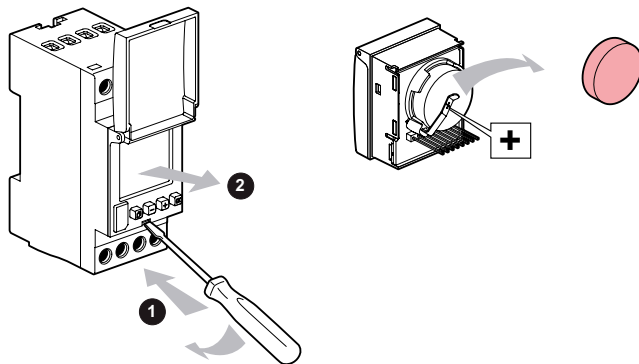

Required inputs, depending on the program type and menu options.

Program type	Execution	Characteristics	ON/OFF times	Weekday assignments	Active period START date	Active period END date	Application, objectives, examples
WEEK	Repeated weekly	MON TO SUN	●	○	○	○	The same switching cycle is to be executed on every day of each week. Example: switch lights on at sunset and off at 22:30:00 hours each day.
		INDIVIDUAL	●	●	○	○	A switching cycle is to be executed only on specific days of each week. Example: switch lights on at sunset and off at 22:30:00 hours on Monday to Friday of each week.
YEAR	EVERY YEAR	MON TO SUN	●	○	Day, month, ----	Day, month, ----	<ul style="list-style-type: none"> A switching cycle is to be executed on each day within a specified period of each year. Example: switch on the outside lights of a church from 17:00:00 to 24:00:00 in the period 1 December to 31 December. An existing weekly program is to be supplemented with additional switching times on each day during a specific period of each year.
		INDIVIDUAL	●	●	Day, month, ----	Day, month, ----	<ul style="list-style-type: none"> A switching cycle is to be executed on certain days of the week within a specified period of each year. Example: switch on the outside lights of a church from 17:00:00 to 24:00:00 on each Sunday in the period 1 December to 31 December. An existing weekly program is to be supplemented with additional switching times on certain days of the week during a specific period of each year.
	ONCE	MON TO SUN	●	○	Day, month, year	Day, month, year	<ul style="list-style-type: none"> A switching cycle is to be executed on each day of a specified period in a specified year. Example: in the year 2012, the heating in a holiday chalet is to be switched on from 07:30:00 to 23:00:00 on each day during the Easter holidays (25 March to 28 March 2012). An existing weekly program is to be supplemented with additional switching times on each day during a specific period of a specific year.
		INDIVIDUAL	●	●	Day, month, year	Day, month, year	<ul style="list-style-type: none"> A switching cycle is to be executed on certain days of a specified period in a specified year. Example: in the current year, the lights in a sports hall are to be switched on from 19:00:00 to 22:00:00 on each Tuesday and Friday during the period from 10 January to 23 March. An existing weekly program is to be supplemented with additional switching times on certain days of the week during a specific period of a specific each year.
	MOVABLE	MON TO SUN	●	○	Day, month, year	Day, month, year	Et årsprogram skal hvert år til påske udføre en omskiftningscyklus. f.eks. skal varmen i et sommerhus i 2014 og i de efterfølgende år dagligt tændes fra kl. 07:30:00 til kl. 23:00:00 i ugen før og ugen efter påske.
		INDIVIDUAL	●	●	Day, month, year	Day, month, year	Et årsprogram skal hvert år på Kristi Himmelfartsdag udføre en omskiftningscyklus. f.eks. skal et bageris udvendige belysning tændes hvert år på Kristi Himmelfartsdag fra kl. 07:00:00 til kl. 11:00:00.

Program-type	Execution	Characteristics	ON/OFF times	Weekday assignments	Active period START date	Active period END date	Application, objectives, examples
EX-CEPTION	EVERY YEAR	MON TO SUN	●	○	Day, month, ---- from 0:00:00 hours	Day, month, ---- to 24:00:00 hours	An exception program is to completely replace any existing weekly or annual program on each day during a specific period of each year. Example: the irrigation pump of an orchard is to be switched on from 17:00:00 to 18:00:00 on each day in the period from 20 March ---- to 10 April ----.
		INDIVIDUAL	●	●	Day, month, ---- from 0:00:00 hours	Day, month, ---- to 24:00:00 hours	An exception program is to completely replace any existing weekly or annual program on certain days during a specific period of each year. Example: the irrigation pump of an orchard is to be switched on from 17:00:00 to 18:00:00 on each Monday and Friday in the period from 11 April ---- to 15 May ----.
		PROG ON	●	○	Day, month, ---- from ON time	Day, month, ---- to OFF time	A channel is to be switched on continuously from the ON time on the START date to the OFF time on the END date every year. This exception program is to completely replace any existing weekly or annual program for this channel. Example: instead of the normal times for illumination of a public building, the illumination is to be switched on from 17:00:00 on the national holiday ---- until 07:00:00 the next morning 4 October ----.
		PROG OFF	●	○	Day, month, ---- from ON time	Day, month, ---- to OFF time	An output is to be switched off continuously from the ON time on the START date to the OFF time on the END date every year. This exception program is to completely replace any existing weekly or annual program for this channel. Example: in order to save power, certain equipment in a factory is to be switched off during the Christmas holiday period of each year. i.e. from 18:00:00 on 23 December ---- to 6:00:00 on 27 December ----.
	ONCE	MON TO SUN	●	○	Day, month, year from 0:00:00 hours	Day, month, year to 24:00:00 hours	On each day during a specific period of a specified year, an exception program is to completely replace any existing weekly or annual program. Example: during the Christmas holidays of the year 2012, the heating in an apartment is to be switched each day from 7:00:00 to 23:00:00, instead of in the normal cycle. This exception period is to begin on 24 December 2012 and end on 06 January 2013.
		INDIVIDUAL	●	●	Day, month, year from 0:00:00 hours	Day, month, year to 24:00:00 hours	On certain weekdays during a specific period of a specific year, an exception program is to completely replace any existing weekly or annual program. Example: in December 2012, the heating system of a department store is to be switched on from 8:00:00 to 18:00:00 each Sunday, because the store opens on Sundays in the period 4 December 2012 to 18 December 2012.
		PROG ON	●	○	Day, month, year from ON time	Day, month, year to OFF time	A channel is to be switched on continuously from the ON time on the START date to the OFF time on the END date of a specific year. This exception program is to completely replace any existing weekly or annual program for this channel. Example: the alarm system of an office building is to be switched on continuously during the vacation period 19:00:00 on 15 July 2012 to 06:00:00 on 7 August 2012.
		PROG OFF	●	○	Day, month, year from ON time	Day, month, year to OFF time	A channel is to be switched off continuously from the ON time on the START date to the OFF time on the END date of a specific year. This exception program is to completely replace any existing weekly or annual program for this channel. Example: in 2012, the normal recess gong in a school is to be switched off during the summer holidays 00:00:00 on 28 July 2012 to 24:00:00 on 10 September 2012.

Program-type	Execution	Characteristics	ON/OFF times	Weekday assignments	Active period START date	Active period END date	Application, objectives, examples
EXCEPTION	MOVABLE	MON TO SUN	●	○	Day, month, ---- from 0:00:00 hours	Day, month, ---- to 24:00:00 hours	Et undtagelsesprogram skal hvert år erstatte et allerede eksisterende årsprogram på en forskydelig helligdag. F.eks. i en kirke skal belysningen tændes og slukkes anderledes på de liturgiske helligdage end med det daglige omskiftningsprogram.
		INDIVIDUAL	●	●	Day, month, ---- from 0:00:00 hours	Day, month, ---- to 24:00:00 hours	Et undtagelsesprogram skal hvert år på tirsdagen efter pinse udføre en omskiftningscyklus. f.eks. skal porten til et fabriksområde ikke åbnes hvert år på tirsdagen efter pinse.
		PROG ON	●	○	Day, month, ---- from ON time	Day, month, ---- to OFF time	Hvert år skal der være tændt permanent til påske. Dette undtagelsesprogram skal helt erstatte andre eventuelt eksisterende uge- eller årsprogrammer. Eksempel: I modsætning til en kirkes normale, daglige belysningstider skal lys tændes hvert år til påske fra kl. 17:00:00 til kl. 24:00:00.
		PROG OFF	●	○	Day, month, ---- from ON time	Day, month, ---- to OFF time	Hvert år skal der permanent slukkes fra tændingstidspunktet på startdatoen til slukningstidspunktet på slutdatoen. Dette undtagelsesprogram skal inden for datointervallet helt erstatte andre eventuelt eksisterende uge- eller årsprogrammer. Eksempel: Energiforsyningen til bestemte anlæg i en virksomhed skal i stedet for det normale forløb slukkes kl. 6:00:00 i påskeferien hvert år.

Select the option PROGRAM / WEEK for a program which is to be executed on a specific days of the week and is to be repeated weekly.

Select the option PROGRAM / YEAR for a program which is to be executed each year or only in a specific year. The execution period within the year can be defined by entering start and end dates.

Select the option PROGRAM / EXCEPTION for a program which is to completely replace existing weekly or annual programs during a specified period.

Priorities of the various program types within the same channel:

	WEEK program	YEAR program	EXCEPTION program
WEEK program	The various weekly programs are ORed together	The various weekly and annual programs are ORed together	The exception program is overriding within its defined period of activity.
YEAR program	The various weekly and annual programs are ORed together	The various annual programs are ORed together	The exception program is overriding within its defined period of activity.
EXCEPTION program	The exception program is overriding within its defined period of activity.	The exception program is overriding within its defined period of activity.	The various exception programs are ORed together

